



2: OPERATIONS & MAINTENANCE MANUAL

VX150 to VX2 TRANSMITTER

Document ID:	NHB-VX150-VX2-OPS
Version:	2.0
Issue Date:	2023-04-20
Status:	Standard



Contact Information

Nautel Limited

10089 Peggy's Cove Road
Hackett's Cove, NS Canada B3Z 3J4

Toll Free: +1.877.6NAUTEL (662.8835)
(Canada & USA only) or

Phone: +1.902.823.3900 or

Fax: +1.902.823.3183

Nautel Inc.

201 Target Industrial Circle
Bangor, Maine USA 04401

Phone: +1.207.947.8200

Fax: +1.207.947.3693

Customer Service (24-hour support)

+1.877.628.8353 (Canada & USA only)

+1.902.823.5100 (International)

Email: support@nautel.com

Web: www.nautel.com

The comparisons and other information provided in this document have been prepared in good faith based on publicly available information. For verification of materials, the reader is encouraged to consult the respective manufacturer's most recent publication on the official website or through contact with Customer Service.

© Copyright 2022 NAUTEL. All rights reserved.

CONTENTS

Contact Information	2.iii
RELEASE CONTROL RECORD	2.vii
DESCRIPTION	2.1.1
Ac-Dc Power Stage	2.1.1
Control/Excitation/Monitor Stage	2.1.2
RF Stage	2.1.4
OPERATING THE TRANSMITTER	2.2.1
User Interfaces	2.2.3
Advanced User Interface (AUI)	2.2.7
Managing and Displaying Dashboard Panels	2.2.16
AUI Main Menu	2.2.24
Front Panel User Interface (FPUi)	2.2.86
ROUTINE MAINTENANCE	2.3.1
Scheduled Maintenance	2.3.1
Replacing an Air Filter	2.3.2
Performing On-Air Checks	2.3.4
NON-STANDARD MAINTENANCE	2.4.1
LIST OF TERMS	2.5.1

RELEASE CONTROL RECORD

ISSUE	DATE	REASON
2.0	2023-04-20	Release 2 for VX low power models. Supports hardware versions: VX150, VX300, VX600 (NARF81A) VX1 (NARF79A) VX1.5, VX2 (NARF80A) Supports software version VX SW 6.1.0 and later.

SECTION 2.1: DESCRIPTION

This section provides a high-level description of the transmitter's key sections. The transmitter circuitry is subdivided into three basic stages:

- Ac-Dc Power Stage
- Control/Excitation/Monitor Stage - see page 2.1.2
- RF Stage - see page 2.1.4

Refer to [Figure Figure 2.1.1](#) through [Figure Figure 2.1.3](#), at the end of this section, for high level block diagrams of the VX150 to VX2. For detailed electrical schematics of the transmitter and its sub-assemblies, refer to Section 4 of the VX150 to VX2 Troubleshooting Manual.

Ac-Dc Power Stage

The ac-dc power stage provides power to operate the +12 V Power Supply, which generates the +12 dc voltage that is used throughout the transmitter. This supplies the voltage to operate cooling fans, IPA (intermediate power amplifier), and power all PWBs. The ac-dc power stage also contains a PA (power amplifier) Power Supply that provides positive dc voltage (PA volts) to the PA PWB(s) for the RF power amplifier(s). The PA Power Supply, and its output voltage range, varies with the transmitter model. For VX150 to VX600 transmitters, the output voltage range is between +18 and 53 V dc. For VX1 to VX2 transmitters, the output voltage range is between +23 and 65 V dc.

For normal operation:

- ❖ VX150 to VX600 transmitters accept a single-phase, 90 - 265 V ac (120/220 V ac nominal) input.
- ❖ VX1 to VX2 transmitters accept a single-phase, 185 - 265 V ac (220 V ac nominal) input.

NOTE: *VX1 to VX2 transmitters can operate from a 90 - 185 V ac input, but at reduced output power.*

The ac-dc power stage consists of Power Supply Interface PWB (A4), Low Voltage Power Supply (LVPS) (U2) and PA power supply (U3).

Power Supply Interface PWB

The Power Supply Interface PWB (A4):

- ❖ accepts the ac input voltage and provides input voltage for the PA Power Supply and +12 V Power Supply.
- ❖ distributes LVPS voltage to the RF drive stage and the control/monitor stage.
- ❖ distributes PA voltage to the PA PWB and the control/monitor stage.

- ❖ provides RS485 serial communication between the System Interface PWB and the +53V PA Power Supply.
- ❖ provides status and alarm outputs from the PA Power Supply, such as Module Present, Power Fail Warning, Rectifier Fault and Overtemp Warning (provided to the System Interface PWB over a serial bus).

+12 V Power Supply

The +12 V Power Supply (U2) converts the ac input voltage to the regulated output (+12 V dc). This voltage is used to power all the PWBs, the cooling fans and the IPA.

PA Power Supply

The PA Power Supply (U3) converts the ac input voltage to a regulated dc supply (PA volts) for the RF amplifier(s). The PA Power Supply, and its output voltage range, varies with the transmitter model. For VX150 to VX600 transmitters, the output voltage range is between +18 and 53 V dc. For VX1 to VX2 transmitters, the output voltage range is between +23 and 65 V dc. The output voltage is regulated based on a serial control input from the Power Supply Interface PWB (A4). The PA Power Supply also senses out-of-regulation on the ac input and dc output, and applies a Power Fail Warning signal to the Exciter PWB. Both conditions cause the PA Power Supply to shut itself down, thus shutting down the transmitter's RF output. Some PA Power Supply signals are applied to the Exciter PWB, via the System Interface PWB, for system level monitoring.

Control/Excitation/Monitor Stage

The control/excitation/monitor stage performs many critical functions for the transmitter. The primary components of the control/excitation/monitor stage are the Exciter PWB (A1), Analog Audio PWB (A2), System Interface PWB (A3), Power Supply Interface PWB (A4), and front panel user interface (FPUI). The FPUI consists of the Display Module (U1) and the Front Panel User Interface PWB (A5).

The Front Panel User Interface PWB uses a rotary pushbutton to navigate through the various FPUI menus. The front panel has a pushbutton switch (BACK) to allow the user to return to the previous menu. There are two front panel LEDs that display the status for remote (enable) ON or OFF and RF ON or OFF.

The Exciter PWB (A1) provides all the user remote I/O (input/output) interfacing for the transmitter. An AUI (advanced user interface) can be remotely accessed, which contains a menu-based series of pages that serve specific functions.

An SD card (U4) provides a storage medium that has the operating system (OS) for the transmitter and stores the presets and calibration data.

Exciter PWB

The Exciter PWB (A1) accepts external audio program information and generates the modulated RF drive source for the IPA PWB (A6). It performs all primary control functions of the transmitter.

Other functions of the Exciter PWB are:

- ❖ accepts analog modulation sources from Analog Audio PWB
- ❖ accepts digital modulation sources
- ❖ generates the signals that enables the PA Power Supply and controls its output voltage
- ❖ hosts Ethernet server and remote control I/O
- ❖ accepts forward power sample from directional coupler
- ❖ accepts interlock input and provides interlock/muting protection
- ❖ accepts SWR shutdown from System Interface PWB

Analog Audio PWB

The Analog Audio PWB (A2) accepts external audio and composite signals, digitizing them for further processing on the Exciter PWB (see the *VX150 to VX2 Installation Manual* for details on various program input types). It also generates a Pilot Sample.

System Interface PWB

The System Interface PWB (A3) interfaces with the Exciter PWB to perform the following functions:

- ❖ contains monitoring and protection circuits to prevent transmitter damage under adverse or fault conditions, including high speed SWR protection.
- ❖ monitors the current value of various parameters including cooling fan tachometer outputs, transmitter output reflected power, heatsink and intake temperature, and PA current levels.
- ❖ measures and monitors the output voltage from the +53 V PA Power Supply as well as the low voltage power supplies.
- ❖ provides local interfacing for the transmitter. Local interfacing is performed via the local FPUI on the transmitter and the front panel LCD display (320 x 240 pixels). The FPUI contains a menu-based series of pages that serve specific functions.

RF Stage

The RF power stage accepts the RF drive input and generates the final RF output.

For VX150 to VX1 transmitters, it consists of Exciter PWB (A1), IPA PWB (A6), PA PWB (A7), PA Low Pass Filter PWB (A9) and Directional Coupler PWB (A11).

For VX1.5 and VX2 transmitters, it consists of Exciter PWB (A1), IPA PWB (A6), Splitter PWB (A12), two PA PWBs (A7 and A8), two PA Low Pass Filter PWBs (A9 and A10), Combiner PWB (A13) and Directional Coupler PWB (A11).

IPA PWB

The IPA PWB amplifies the RF drive signal from the Exciter PWB to the proper level required to drive the RF amplifier(s) in the PA PWB(s).

For VX150 to VX1 transmitters, the IPA's output RF drive signal is applied to the System Interface PWB, where the PA Bias dc voltage is coupled onto the RF drive signal, then it is applied to the PA PWB.

For VX1.5 and VX2 transmitters, the IPA's output RF drive signal is applied through the System Interface PWB to the Splitter PWB, where the PA Bias dc voltage is coupled onto the RF drive signals, then they are applied to PA PWBs.

Splitter PWB

Used in VX1.5 and VX2 transmitters only. The Splitter PWB splits the RF signal from the IPA PWB into two equal amplitude signals for the two PA PWBs. Two bias signals are coupled to the RF signals to provide RF + Bias drive signals to the two PA PWBs.

PA PWB(s)

The PA PWB(s) accepts the RF + Bias drive from the System Interface PWB (for VX150 to VX1) or from the Splitter PWB (for VX1.5 and VX2), and PA volts input from the Power Supply Interface PWB. The RF output of the PA PWB(s) is controlled by a combination of gate bias set point, RF drive and PA volts. At low power levels, the RF drive level must be reduced to reduce power below the minimum possible level at minimum PA volts.

PA Low Pass Filter PWB(s)

The PA low pass filter PWB(s) (A9 and A10, as applicable) is connected to the output of the PA PWB(s) to reject harmonics prior to being applied to the Directional Coupler (A11) (via the Combiner PWB for VX1.5 and VX2 transmitters).

Combiner PWB

Used in VX1.5 and VX2 transmitters only. The Combiner PWB combines the RF output signals from both PA PWBs and applies it to the Directional Coupler (A11).

Directional Coupler

The Directional Coupler (A11) samples the transmitter's forward and reflected power and generates the Fwd Pwr Sample (A11J2) and Refld Pwr Sample (A11J3) signals applied to the Exciter PWB and System Interface PWBs for protection and monitoring. RF monitor provides -33 dBc typical, -32 dBc maximum coupling (minimum 1 V RMS at 75 W) at A11J1, which is applied to the panel mount BNC connector on the rear panel. This can be used with a modulation monitor.

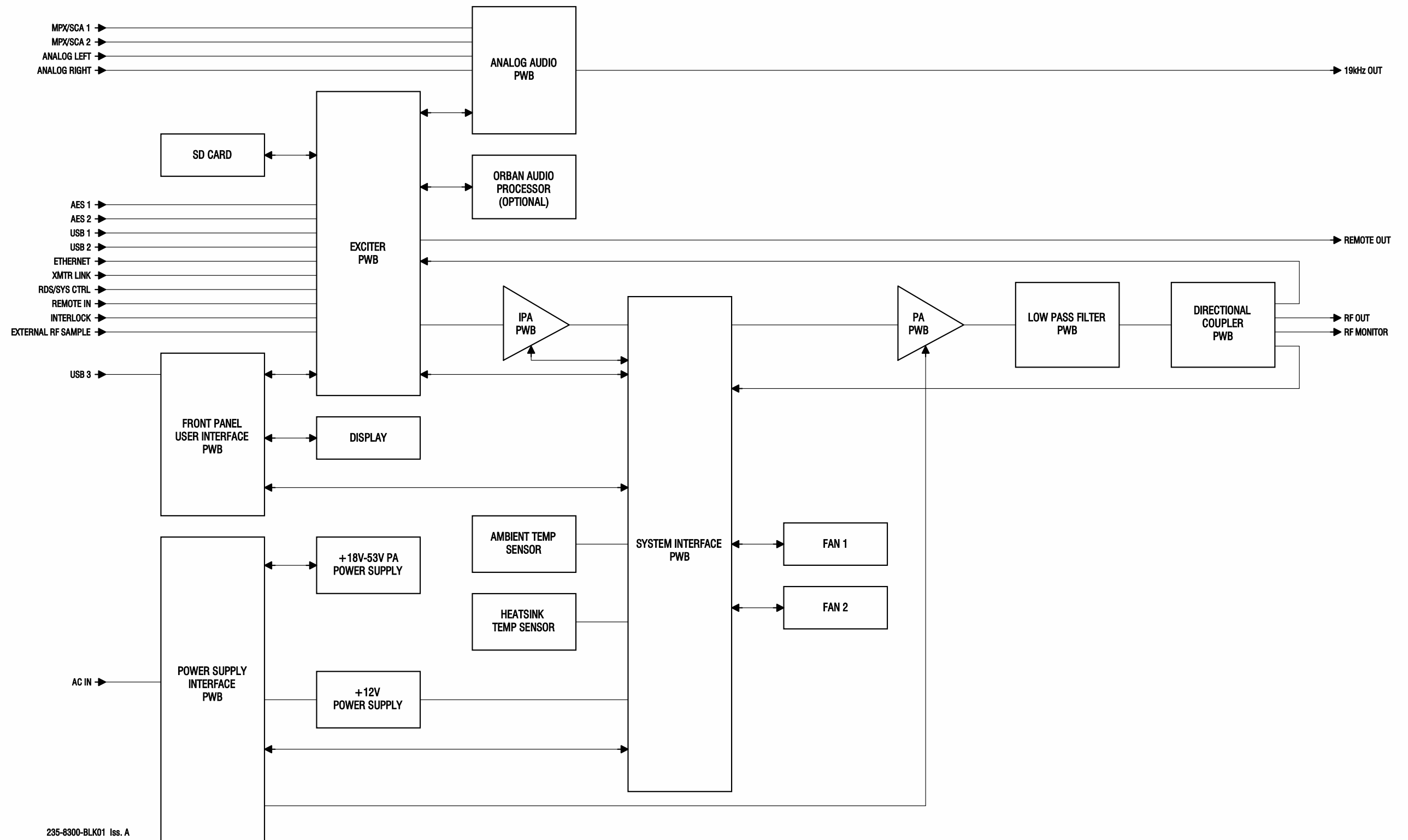

Figure 2.1.1: VX150/VX300/VX600 Transmitter Block Diagram

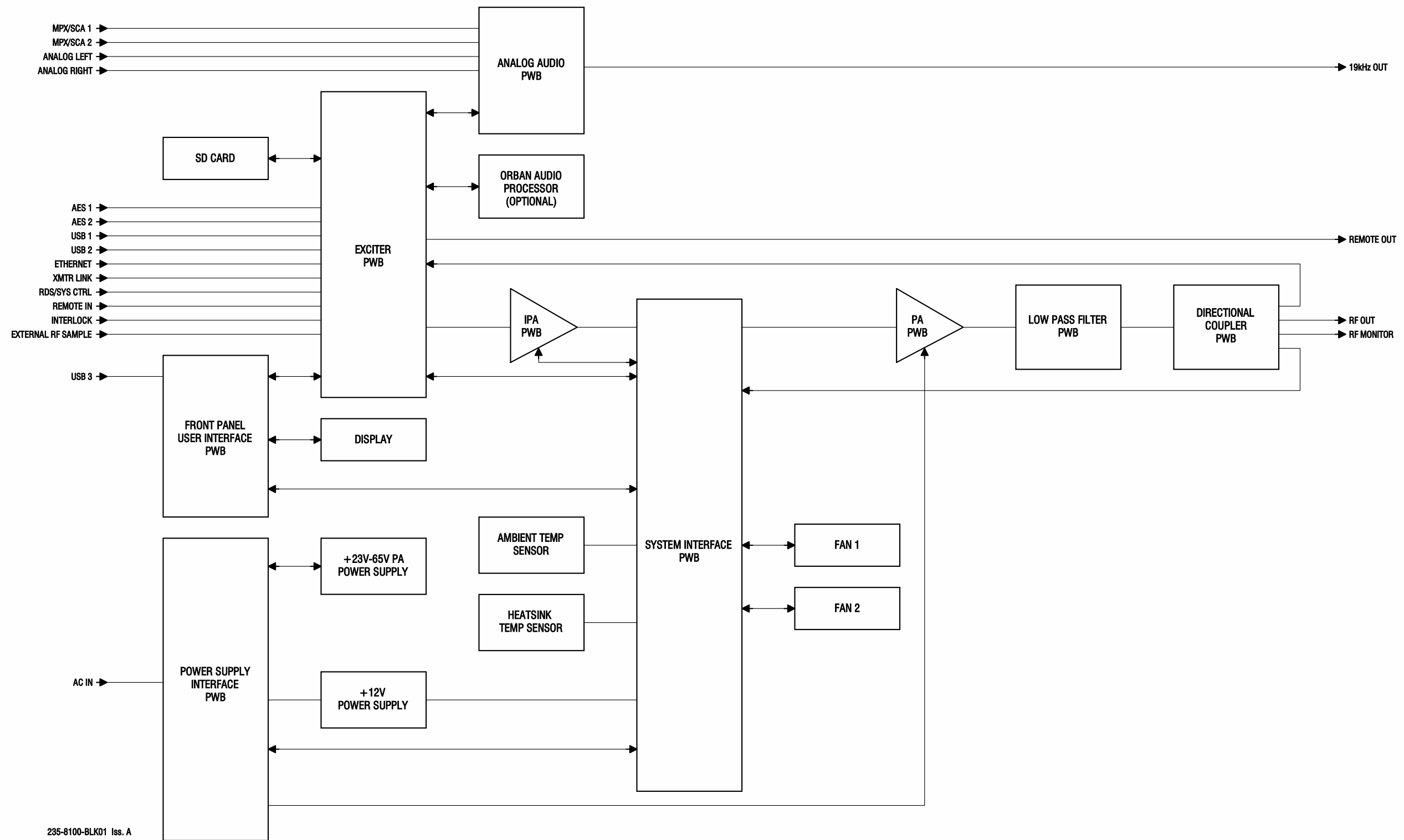

Figure 2.1.2: VX1 Transmitter Block Diagram

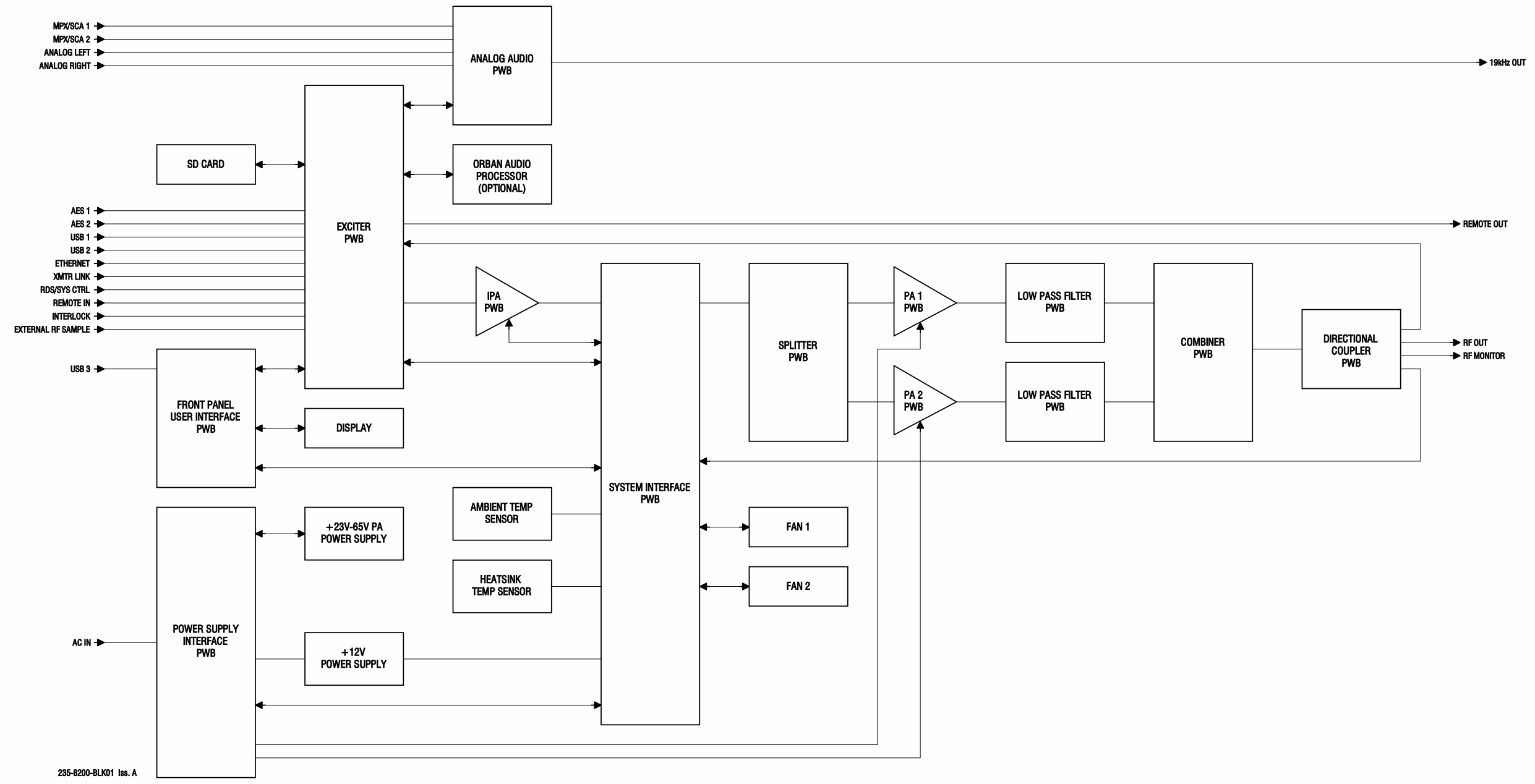

Figure 2.1.3: VX1.5/VX2 Transmitter Block Diagram

SECTION 2.2: OPERATING THE TRANSMITTER

This section provides the following information about operating the VX150 to VX2 transmitter:

- [User Interfaces - see page 2.2.3](#)
- [Advanced User Interface \(AUI\) - see page 2.2.7](#)
 - ❖ [Logging into the AUI - see page 2.2.10](#)
 - ❖ [AUI Pages - see page 2.2.12](#)
 - ❖ [AUI Menu page - see page 2.2.14](#)
- [Managing and Displaying Dashboard Panels - see page 2.2.16](#)
 - ❖ [Describing Dashboard Panel Options - see page 2.2.18](#)
 - ❖ [Alarms - see page 2.2.19](#)
 - ❖ [Audio Inputs - see page 2.2.19](#)
 - ❖ [Modulation - see page 2.2.20](#)
 - ❖ [Dashboard Meters - see page 2.2.20](#)
 - ❖ [Spectrum Analyzer - see page 2.2.22](#)
- [AUI Main Menu - see page 2.2.24](#)
 - ❖ [Alarms - see page 2.2.25](#)
 - ❖ [Meters - see page 2.2.26](#)
 - ❖ [Presets - see page 2.2.28](#)
 - ❖ [Scheduler - see page 2.2.46](#)
 - ❖ [Settings - see page 2.2.48](#)
 - ❖ [Audio Processing - see page 2.2.49](#)
 - ❖ [Exciter VCXO - see page 2.2.52](#)
 - ❖ [External 10 MHz - see page 2.2.53](#)
 - ❖ [Network - see page 2.2.54](#)
 - ❖ [Notifications - see page 2.2.56](#)
 - ❖ [Security Certificates - see page 2.2.59](#)

- ❖ [SNMP](#) - see page 2.2.60
- ❖ [Spectrum Mask](#) - see page 2.2.62
- ❖ [System Preferences](#) - see page 2.2.63
- ❖ [Thresholds](#) - see page 2.2.63
- ❖ [Time](#) - see page 2.2.64
- ❖ [Transmitter Info](#) - see page 2.2.66
- ❖ [Users](#) - see page 2.2.67
- ❖ [Remote I/O](#) - see page 2.2.71
- ❖ [Reports](#) - see page 2.2.77
- ❖ [Software](#) - see page 2.2.82
- ❖ [Sign Out](#) - see page 2.2.85
- [Front Panel User Interface \(FPU\)](#) - see page 2.2.86
 - ❖ [Front Panel UI Menu](#) - see page 2.2.87
 - ❖ [Alarms](#) - see page 2.2.91
 - ❖ [Logs](#) - see page 2.2.92
 - ❖ [Meters](#) - see page 2.2.94
 - ❖ [Network](#) - see page 2.2.100
 - ❖ [Presets](#) - see page 2.2.103
 - ❖ [Settings](#) - see page 2.2.119
 - ❖ [Software](#) - see page 2.2.141

User Interfaces

NOTE: Nautel recommends you make a complete backup clone of the transmitter's SD card in the event the SD card in the transmitter becomes corrupted or damaged. Use a Class 10 SD card with a minimum 8 GB capacity (e.g., Nautel part number UB114, vendor part number Cactus KS8GR-245, or equivalent).

The user can interface with the VX150 to VX2 using one of three methods:

- Remotely, via a LAN connection, using the Advanced User Interface (AUI) pages (see [Advanced User Interface \(AUI\)](#)). You can enable remote control from the front panel by pressing the Remote button, which will turn green when enabled.
- Locally, using the transmitter's Front Panel UI and its rotary button (see [Front Panel User Interface \(FPUI\)](#), on page 2.2.86).
- Remotely, via remote input/output (I/O) wiring connected to the rear of the transmitter to the remote I/O D-sub connectors on the rear panel (see [Remote I/O](#), on page 2.2.71 for AUI or [Remote I/O](#), on page 2.2.130 for FPUI). Refer to the VX150 to VX2 Installation Manual for I/O details).

See the complete menu hierarchy illustrated in Figure 2.2.2 (for the remote AUI menu) and Figure 2.2.3 (for the Front Panel UI menu). When a user interfacing function can be performed from both the AUI and the Front Panel UI, both are described in this section.

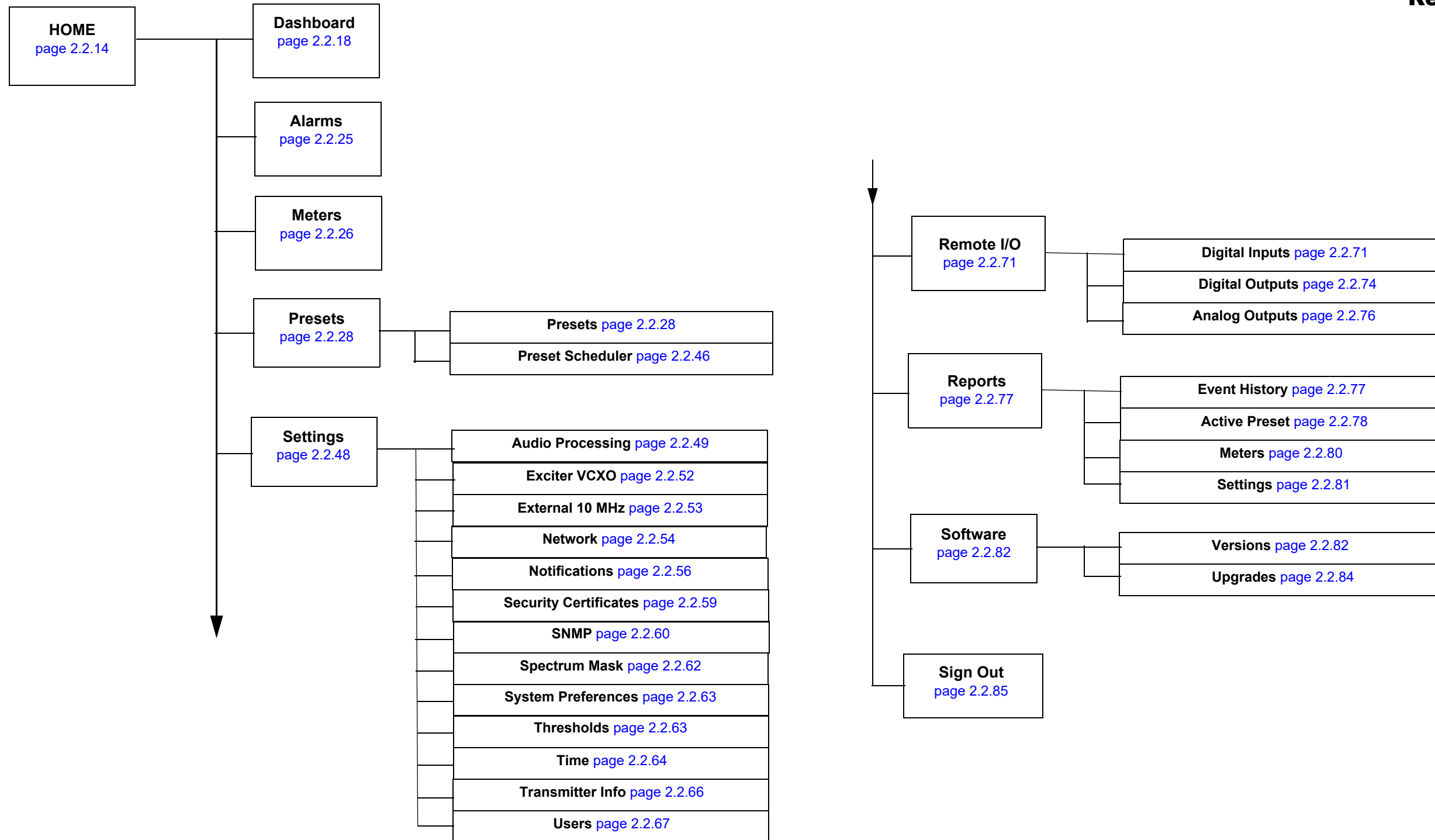

Figure 2.2.2: VX Transmitter AUI Flow Diagram

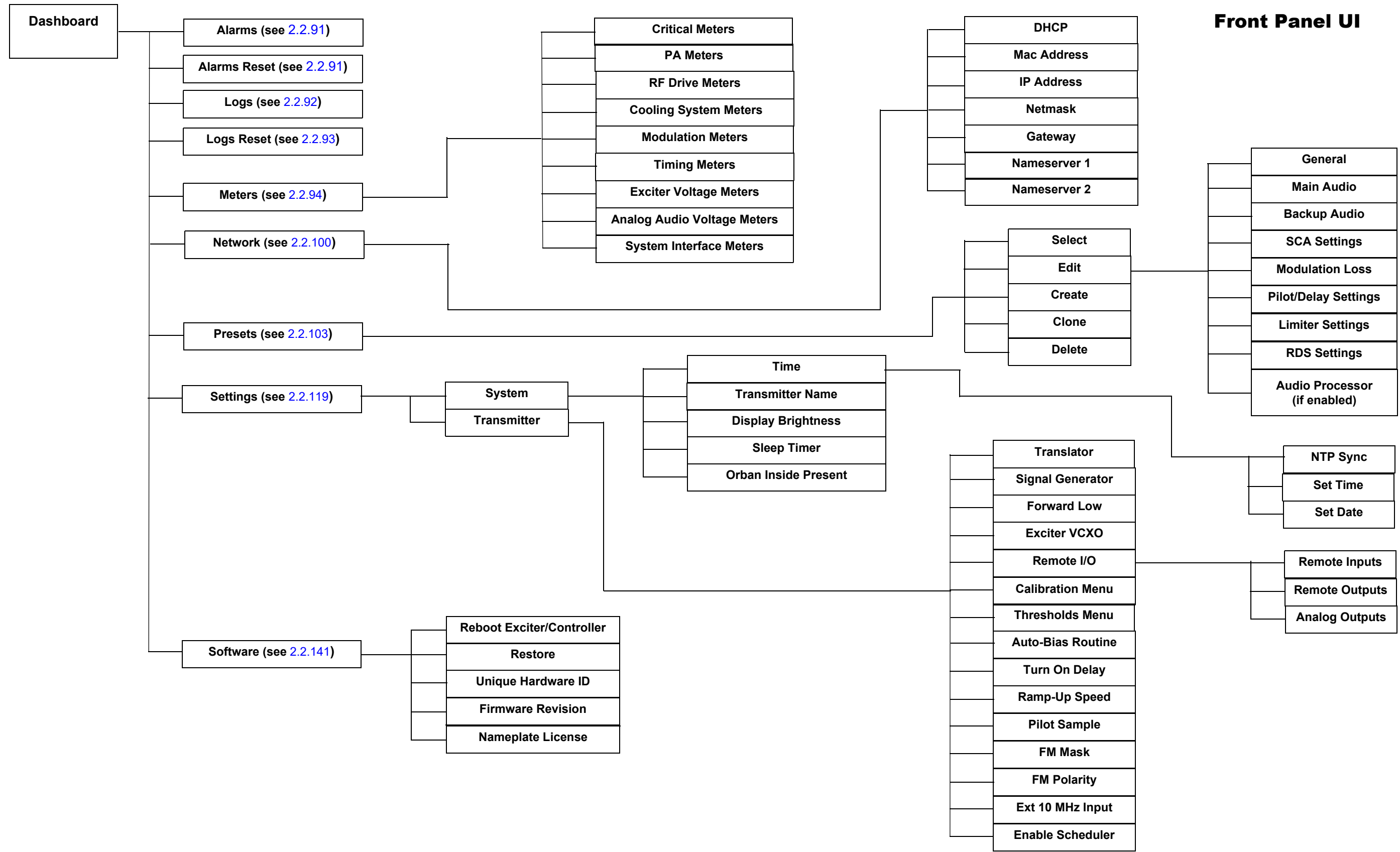

Figure 2.2.3: VX150 to VX2 Transmitter - Front Panel UI Menu Tree

Advanced User Interface (AUI)

The VX150 to VX2 uses an Advanced User Interface (AUI). You can access the AUI remotely using a PC and a web browser, directly or through a switch or network - via the LAN connection on the rear panel of the transmitter.

NOTE: Nautel recommends you clear your browser's history before viewing the remote AUI.

This section includes the following topics:

- [Logging into the AUI, on page 2.2.10](#)
- [AUI Pages, on page 2.2.12](#)
- [Managing and Displaying Dashboard Panels, on page 2.2.16](#)

Each AUI page provides information about a specific transmitter function. All navigation through the AUI pages begins on the main screen (or Dashboard), shown in [Figure 2.2.1 on page 2.2.8](#).

Figure 2.2.1: Using the AUI (Dashboard page shown)

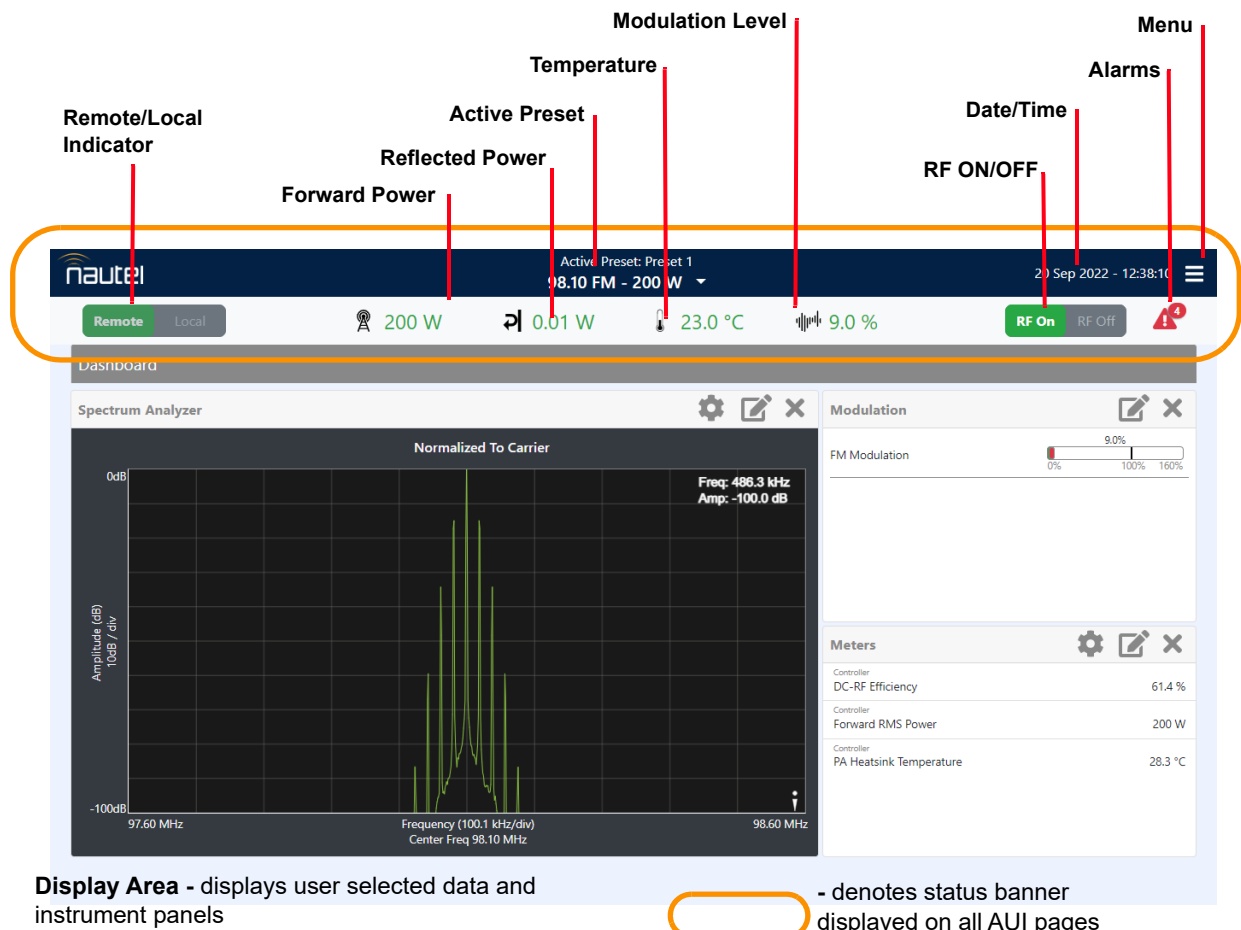

The top banner is permanent on all AUI pages and includes:

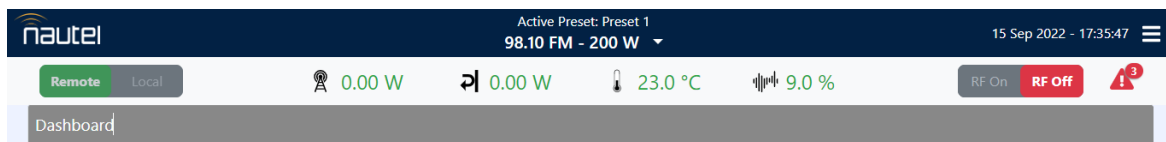

- **Menu:** Click to display further operations options, which allows navigation to various other pages (see [AUI Menu page on page 2.2.14](#)). Note: when Menu is selected, the three horizontal lines change to three vertical lines.
- **Active Preset:** Displays the name of the active preset (e.g., Preset 1), call sign, carrier frequency in MHz, mode (e.g., FM), and power set point. Click the down arrow to see other available presets and initiate a preset change (see [Managing Presets - Using the AUI on page 2.2.28](#)).

- **Date & Time:** Displays day, month, year and current time. To set the time, see [Time on page 2.2.64](#).
- **Nautel Logo:** From any page, click the Nautel logo to return to the Dashboard page.
- **Remote/Local:** Indicator showing the operational control of the transmitter. In Remote mode, the button is green and Local is gray. If Local is selected, only local control of the transmitter is possible and the button will be red and Remote will be gray. To change the local/remote status from the front panel, press the Remote button.

NOTE: Local changes can always be made while Remote access is enabled/disabled using the front panel's REMOTE button.

- **Forward Power:** Displays the current forward power level of the transmitter.
- **Reflected Power:** Displays the current reflected power level of the transmitter.
- **Temperature:** Displays the current Inlet temperature.
- **Modulation:** Displays the current modulation percentage of the transmitter.
- **RF On/Off:** Buttons that determine the on/off status of the transmitter's RF power stage. The RF On button is highlighted green indicating the current setting and RF Off is gray. Click RF On to enable the transmitter's RF power stage. Click RF Off to disable the transmitter's RF power stage, the RF On button will turn gray and RF Off will turn red.
- **Active Alarms:** Displays the alarms that are currently active on the transmitter. Click on the alarm to go to the Alarms page (see [Alarms on page 2.2.25](#)), which provides details for current alarms as well as an option to view alarm history. When a critical-level alarm is being reported, the transmitter is in an 'off-air' state. When a maintenance-level alarm is being reported, the transmitter may still be 'on-air', but possibly at reduced power. When the transmitter is operating normally, no alarm symbols will display.

Logging into the AUI

The transmitter's AUI provides a means to restrict access to transmitter control functions to authorized users only. There are user accounts that can be pre-defined to set access restriction from read-only (no control) to full-administrative control.

Access the AUI using a web browser as follows:

1. Configure your network settings (see [Network on page 2.2.54](#)).
2. On your router or firewall software, open port 80 and close (restrict access to) all other ports. If you are using RDS data, open port 7005. If you are using SNMP, open port 161 (Agent) or 162 (Traps). SSL requires port 443.
3. When properly configured as noted above, the login menu (see [Figure 2.2.4 on page 2.2.11](#)) will appear in your web browser when the IP address is accessed. Your IP address and any login messages appear in a box at the top, beside the logo.

If the login menu does not appear, then your login may not be properly configured and you should consult the documentation for the User Accounts page ([Users on page 2.2.67](#)).

4. The AUI has two predefined user accounts: Admin and Viewer. The Admin account has full permissions on the transmitter, while the Viewer account can only view AUI pages and cannot make any changes. The default passwords for these logins are:
 - Admin: change_me
 - Viewer: <blank>
5. Log in to the AUI by entering the appropriate parameters in the login window.
 - In the Language field, click the down-arrow to review a drop-down menu displaying the available language options, and select one.
 - In the User field, enter the administrator user name "Admin".
 - In the Password field, enter the password. Default is "change_me". Click on the eyeball icon to see the characters of the password.

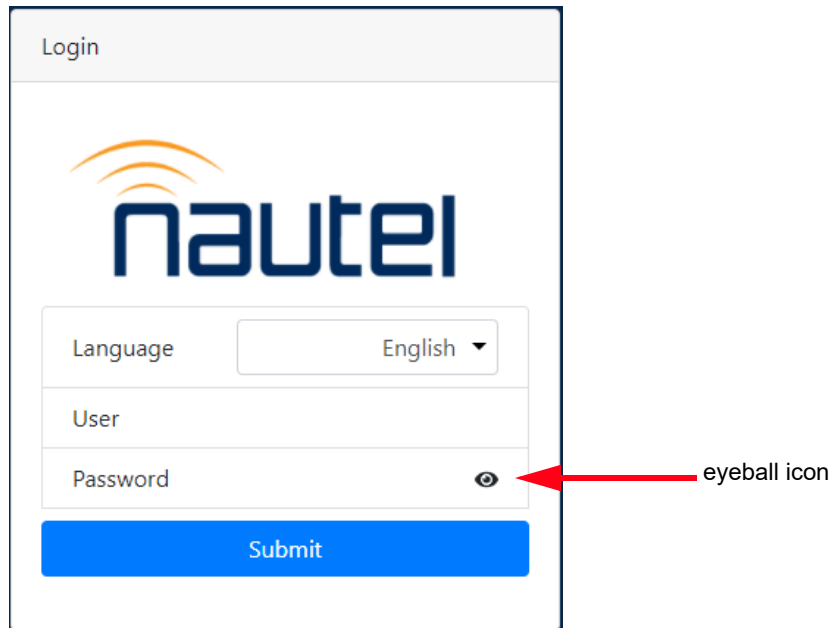
Figure 2.2.4: AUI Login Menu

The screenshot shows a web-based login interface for Nautel. At the top, there is a header labeled 'Login'. Below the header is the Nautel logo, which consists of three orange curved lines above the word 'nautel' in a blue, lowercase, sans-serif font. Underneath the logo are three input fields: a 'Language' dropdown menu currently showing 'English', a 'User' text input field, and a 'Password' text input field. To the right of the password field is a small black and white eyeball icon. A red arrow points from the text 'eyeball icon' to this icon. At the bottom of the form is a blue button with the word 'Submit' in white text.

NOTE: The Nautel AUI is factory configured with two pre-defined logins. Nautel recommends that you change the password to improve overall system security (see [Set or Change the Password](#), on page 2.2.69).

- Click Submit to accept your login parameters and display the AUI home page ([Figure 2.2.1 on page 2.2.8](#)).

NOTE: The opening screen (the Home page) will have the layout from the previous login session.

NOTE: If you do not have a user account, it must be set up by an existing user with proper permissions. See [Adding/Editing Account Information](#) on page 2.2.68.

AUI Pages

Table 2.2.1 defines the available AUI pages.

Table 2.2.1: AUI Pages

AUI Page	Function	Page
Dashboard	Present critical data and instruments.	page 2.2.14
Panel Selector	Choose data and instrument panels for Dashboard.	page 2.2.16
Menu	Page navigation and AUI logout (see Menu options below).	page 2.2.24
Menu - Alarms	View active faults.	page 2.2.25
Menu - Meters	View Exciter and Controller meter lists.	page 2.2.26
Menu - Presets	Activate, create, and edit presets. Define and manage calendar-based preset schedule.	page 2.2.28
Menu - Settings	Manage all transmitter settings and options (see Settings options below).	page 2.2.48
Menu - Settings - Audio Processing	Select and modify Orban Audio Processing presets.	page 2.2.49
Menu - Settings - Exciter VCXO Calibration	Calibrate the 10 MHz Int-Ext Offset and set the VCXO value.	page 2.2.52
Menu - Settings - External 10 MHz	Enable or disable the use of an external 10 MHz signal.	page 2.2.53
Menu - Settings - Network	View network information status.	page 2.2.54
Menu - Settings - Notifications	Configure alarm notifications and email setup.	page 2.2.56
Menu - Settings - Security Certificates	Provides an option to for enhanced security by uploading a security certificate.	page 2.2.59
Menu - Settings - SNMP	SNMP agent and traps configuration: enables notifications using a MIB browser and an alternative remote control and access.	page 2.2.60
Menu - Settings - Spectrum Mask	Select Spectrum mask type: FCC, ETSI or none.	page 2.2.62
Menu - Settings - System Preferences	Select temperature display: Celsius or Fahrenheit.	page 2.2.63
Menu - Settings - Thresholds	Configure Low Forward Power and Very Low Forward Power thresholds.	page 2.2.63

AUI Page	Function	Page
Menu - Settings - Time	Select NTP, UTC, and set date, time, country and time zone.	page 2.2.64
Menu - Settings - Transmitter Info	View and enter transmitter name and serial number.	page 2.2.66
Menu - Settings - Users	Create and edit user accounts and permissions.	page 2.2.67
Menu - Remote I/O	Define remote inputs and outputs, monitor analog outputs	page 2.2.71
Menu - Reports	View and download reports on transmitter operation: events, active preset, meters, and settings.	page 2.2.77
Menu - Software Versions	View installed software versions and licenses.	page 2.2.82
Menu - Software Upgrade	Select and manage installable software.	page 2.2.84
Menu - Sign Out	Sign out of the AUI session.	page 2.2.85

AUI Menu page

NOTE: Any menu item or feature in the Remote AUI that is grayed out is not available.

From the AUI's top banner, click the Menu button to view the Menu page (see [Figure 2.2.5](#)). From this page, you can select one of the following sub-menus:

Figure 2.2.5: Main Menu Page

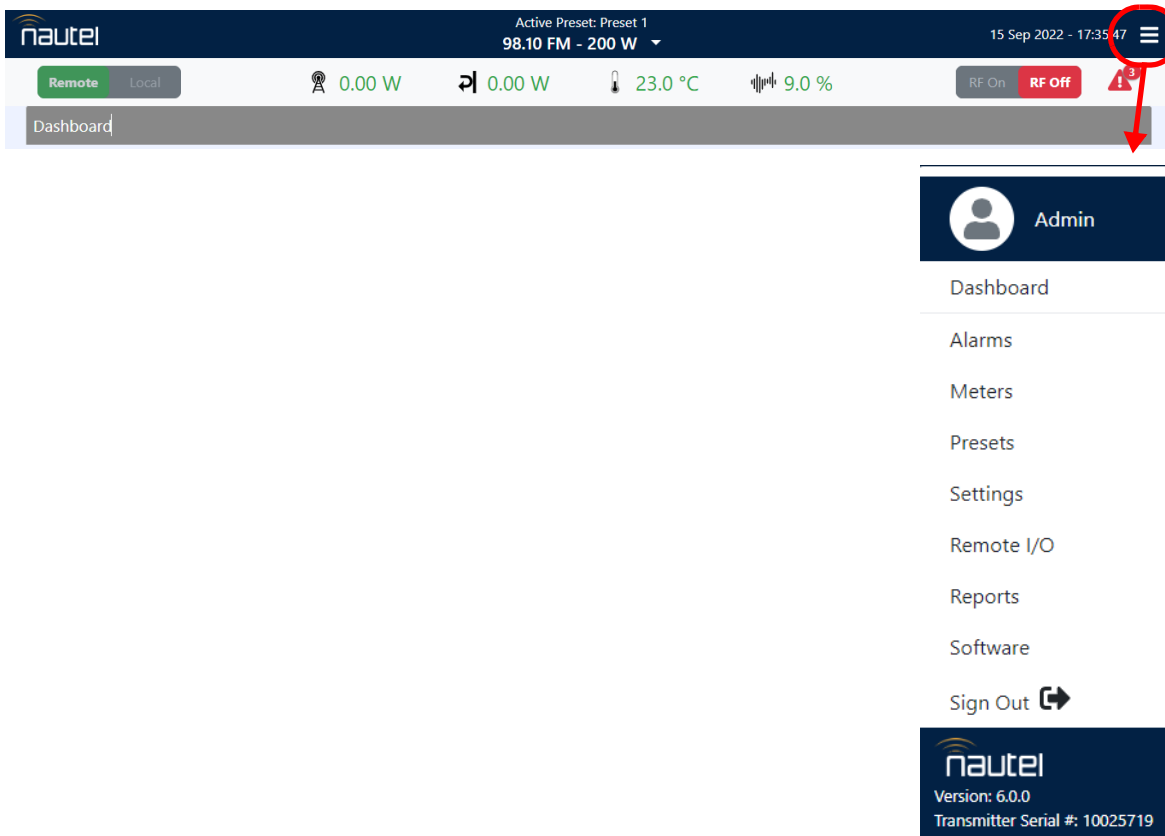

- Select Alarms to view, download or reset any current alarms (see [Alarms - see page 2.2.25](#)).
- Select Meters to view real time meters, displays all transmitter meters (see [Meters - see page 2.2.26](#)).
- Select Presets to view, load or edit available presets/schedule and create new presets (see [Pre-sets - see page 2.2.28](#)).

- Select Settings to access a sub-menu of settings options, including:
 - Audio Processing (see [Audio Processing - see page 2.2.49](#))
 - Exciter VCXO (see [Exciter VCXO - see page 2.2.52](#))
 - External 10 MHz (see [External 10 MHz - see page 2.2.53](#))
 - Network (see [Network - see page 2.2.54](#))
 - Notifications (see [Notifications - see page 2.2.56](#))
 - Security Certificates (see [Security Certificates - see page 2.2.59](#))
 - SNMP (see [SNMP - see page 2.2.60](#))
 - Spectrum Mask (see [Spectrum Mask - see page 2.2.62](#))
 - System Preferences (see [System Preferences - see page 2.2.63](#))
 - Thresholds (see [Thresholds - see page 2.2.63](#))
 - Time (see [Time - see page 2.2.64](#))
 - Transmitter Info (see [Transmitter Info - see page 2.2.66](#))
 - Users (see [Users - see page 2.2.67](#))

- Select Remote I/O to configure remote inputs and outputs, and the available analog outputs (see [Remote I/O - see page 2.2.71](#)).

- Select Reports to view or download the Alarm History (see [Reports - see page 2.2.77](#)).

- Select Software to perform a software upgrade or view or upload the Firmware or Software files (see [Software - see page 2.2.82](#)).

- Select Sign Out to log out of the AUI session and return to the login menu. See [Sign Out - see page 2.2.85](#). To log in again, use your remote PC's keyboard to enter your Username and Password, then click the Submit button. If you do not have a user account, see [Logging into the AUI - see page 2.2.10](#).

Managing and Displaying Dashboard Panels

This section includes the following topics:

- [Describing Dashboard Panel Options - see page 2.2.18](#)
- [Alarms - see page 2.2.19](#)
- [Audio Inputs - see page 2.2.19](#)
- [Modulation - see page 2.2.20](#)
- [Dashboard Meters - see page 2.2.20](#)
- [Spectrum Analyzer - see page 2.2.22](#)

The AUI provides up to five measurement/status related tools, or panels, that you can select to display on the AUI's Dashboard (see [Figure 2.2.1 on page 2.2.8](#)).

Up to five panels can be displayed at one time, a larger panel on the left-hand side of the Dashboard and four smaller panels on the right-hand side.

NOTE: Smaller panels can be hidden from view based on display size/scaling.

To view all the panel options, select the Change Panel (edit) icon in the top, right corner of any displayed panel. You can also remove a panel by clicking the Remove Panel (X) icon in its top, right corner, then replace it by clicking the + symbol to see the panel options. Clicking the Save button adds the selected panel to the Dashboard. Clicking the Cancel button discards any changes. See [Figure 2.2.6 on page 2.2.17](#) for a more detailed view of the panel options.

Figure 2.2.6: Panels displayed on Dashboard

Change Panel Remove Panel

One larger panel displayed here

Up to four smaller panels displayed here

Panel Selector

Data Panels

- Alarms
- Audio Inputs
- Modulation
- Meters

Instrument Panels

- Spectrum Analyzer
- Power Distribution
- EQ Frequency Response
- Lissajous Plot
- AM-AM Correction
- AM-PM Correction
- Constellation

Cancel Save

NOTE: For consistency the panel selector dialog is the same for all Nautel FM transmitters. If an instrument is greyed out, it is not currently available on the transmitter series you are logged into.

Describing Dashboard Panel Options

Click on the desired panel to display it. See [Table 2.2.2](#) for a description of each panel, noting there are two types - Data Panels and Instrument Panels. Data Panels display read-only measurement data. Instrument Panels display graphical information with varying levels of cursor interactivity, depending on the panel. See [Figure 2.2.7](#).

The Description column of [Table 2.2.2](#) includes more detail for each panel.

Figure 2.2.7: Panel Options

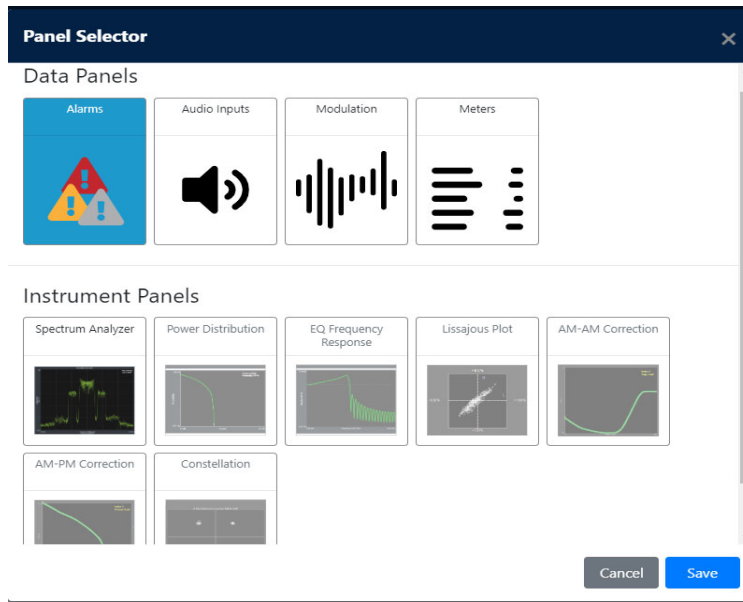

Table 2.2.2: Dashboard Panels

Panel	Description	Page
Alarms	Active transmitter alarms listing.	page 2.2.19
Audio Inputs	Graphic meters for audio inputs.	page 2.2.19
Modulation	Active exciter indicator and graphic modulation meter.	page 2.2.20
Meters	Customizable transmitter meter list.	page 2.2.20
Spectrum Analyzer	Graphical instrument that visualizes RF output.	page 2.2.22

Alarms

See [Figure 2.2.8](#). Displays all active transmitter alarms recognized by the transmitter. A scroll bar will display, as required. The alarms listed in this panel should match the number of alarms shown in the top banner of the AUI. Go to the Menu - Alarms page for alarm details (see [Alarms on page 2.2.25](#)).

Figure 2.2.8: Alarms Panel

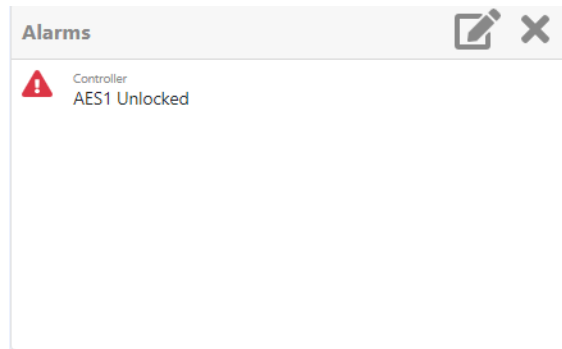

Audio Inputs

See [Figure 2.2.9](#). Displays preset audio inputs and monitor the levels relative to the input level defined in the active preset. Each audio input has a line that displays the current level (green bar) and its full-scale value.

Figure 2.2.9: Audio Inputs Panel

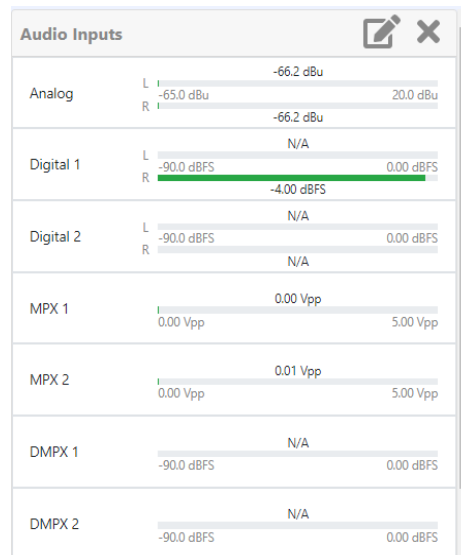

Modulation

See [Figure 2.2.10](#). Displays the FM modulation level for the current preset. The current modulation level is displayed as follows: (green bar), its peak level (black line and shown numerically) and its full-scale value (typically 100%). If the input’s modulation exceeds the full-scale value, the bar colour changes to red.

Figure 2.2.10: Modulation Panel

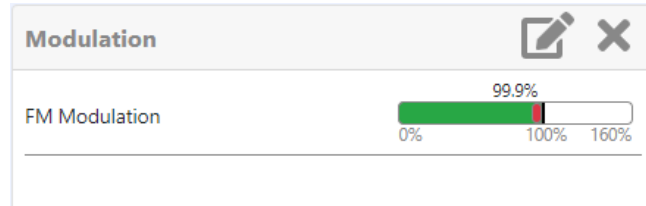

Dashboard Meters

See [Figure 2.2.11](#). Displays a customizable list of transmitter meters, including a scroll bar. Select a meter by clicking the box adjacent to the meter parameter, a blue check mark will indicate it is selected and click Save to display the parameters on the Dashboard. See [Figure 2.2.12 on page 2.2.21](#).

Figure 2.2.11: Dashboard Meters Panel

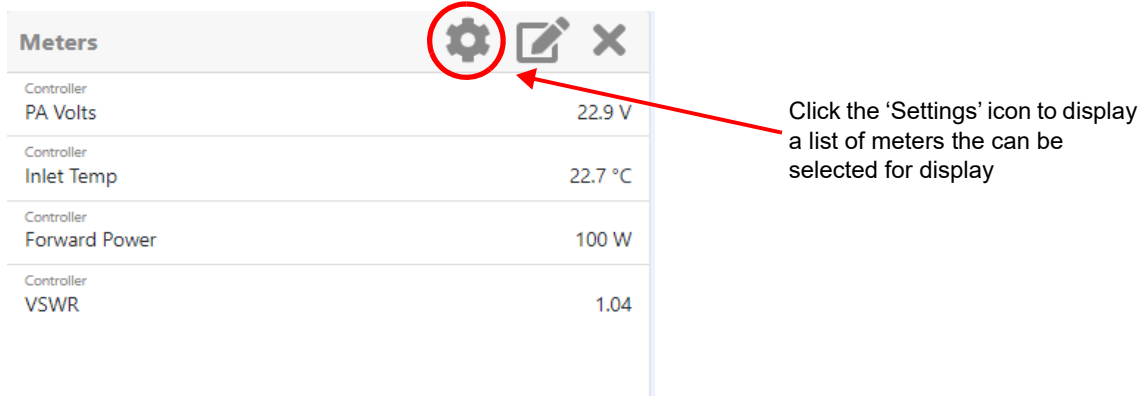

Figure 2.2.12: Dashboard Meters Selection

Meter Name	Selected
Controller RF DAC Temperature	<input type="checkbox"/>
Controller IPA Forward Power	<input type="checkbox"/>
Controller Inlet Temp	<input checked="" type="checkbox"/>
Controller +12 VDC	<input type="checkbox"/>
Controller +3.3 VDC	<input type="checkbox"/>
Controller 10 MHz Delta	<input type="checkbox"/>
Controller Total PA DC Current	<input type="checkbox"/>
Controller Total DC Power	<input type="checkbox"/>
Controller Forward Power	<input checked="" type="checkbox"/>
Controller VSWR	<input checked="" type="checkbox"/>

Buttons: Cancel, Save

Click the 'box' icon to display meters on the Dashboard

Partial Meter List shown for reference

Spectrum Analyzer

See [Figure 2.2.13](#). The carrier level is normalized to its unmodulated carrier level at 0 dB. The graph center is always at the carrier frequency, as defined by the active preset's frequency.

Figure 2.2.13: Spectrum Analyzer Panel

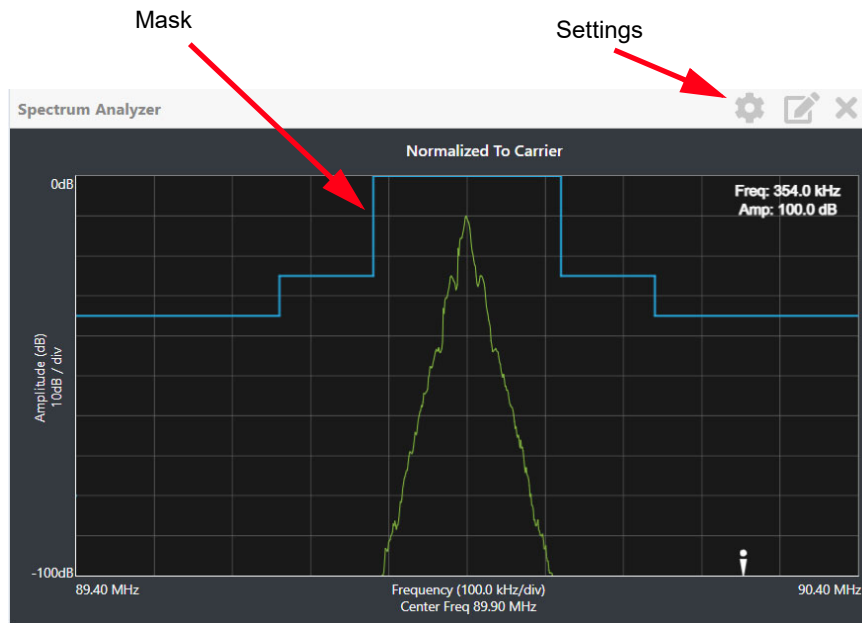

Masks are shown based on transmission mode and are defined by the latest versions of the following standards:

- European Standard: ETSI EN 302 018-2
- FCC CFR 47, Part 73.317 and IC BETS-6e

Refer [Spectrum Mask](#), on [page 2.2.62](#) to set the mask type.

NOTE: The spectrum analyzer may display artifacts (spurs) as some operating carrier frequencies that are a function of the analyzer and are not actually present on the output of the transmitter. If these spurious emissions are observed on the spectrum analyzer, Nautel recommends that a calibrated, external spectrum analyzer be used to verify the presence of spurs.

Click the panel to display a cursor on the nearest peak on the spectrum. The cursor position (frequency and amplitude) is noted in the upper, right-hand corner of the panel.

Click and hold the left mouse button and move the cursor to make fine adjustments.

Click the "Settings" button to gain access to spectrum settings (see [Figure 2.2.14](#)) such as:

- Resolution Bandwidth: determines the FFT bin size or the smallest frequency that can be resolved. Allowable range is 75 - 10,000 Hz. Default setting is 1000 Hz.
- Averages: determines the number of averages that the analyzer performs per sweep. Press the Clear Averaging button to restart the averaging process. Allowable range is 0 - 100. Default setting is 19.
- Span: determines the start and stop frequencies of the analyzer with the carrier frequency always at the center. Allowable range is 10 - 1200 kHz. Default setting is 1000 kHz.
- Measurement Options: determines the source of the spectrum plot that is being displayed. Selecting Internal (FM) uses the exciter’s RF signal, before being equalized (if applicable). Spectrum analyzer bandwidth is defaulted to 1 MHz, but can be increased to 1.2 MHz. Selecting MPX bandwidth displays the entire composite baseband signal (100 kHz wide).

Figure 2.2.14: Spectrum Settings

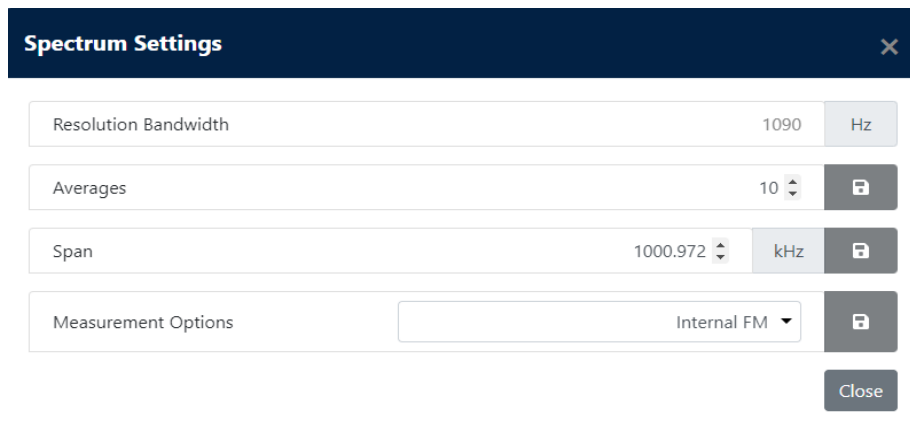

NOTE: The FM spectrum analyzer displays the ideal spectrum generated by the DSP. It is not necessarily the same as the spectrum seen at the RF output.

AUI Main Menu

The Main Menu contains the following features (see [Figure 2.2.15](#)):

- Dashboard
- Alarms (see [page 2.2.25](#))
- Meters (see [page 2.2.26](#))
- Presets (see [page 2.2.28](#))
- Settings (see [page 2.2.48](#))
- Remote I/O (see [page 2.2.71](#))
- Reports (see [page 2.2.77](#))
- Software (see [page 2.2.82](#))
- Sign Out (see [page 2.2.85](#))

Figure 2.2.15: Main Menu

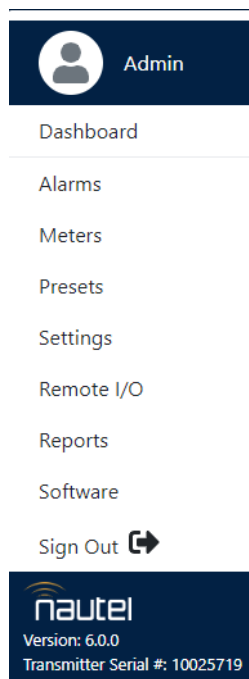

Alarms

You can view the VX150 to VX2's operational status using the AUI's Alarm page. This page shows current active alarms to aid in fault diagnosis. To view, click the Alarms button in the AUI's main menu. See [Figure 2.2.16](#).

You can also use the front panel UI to view active alarms (see [Alarms on page 2.2.91](#)).

Figure 2.2.16: Alarms page

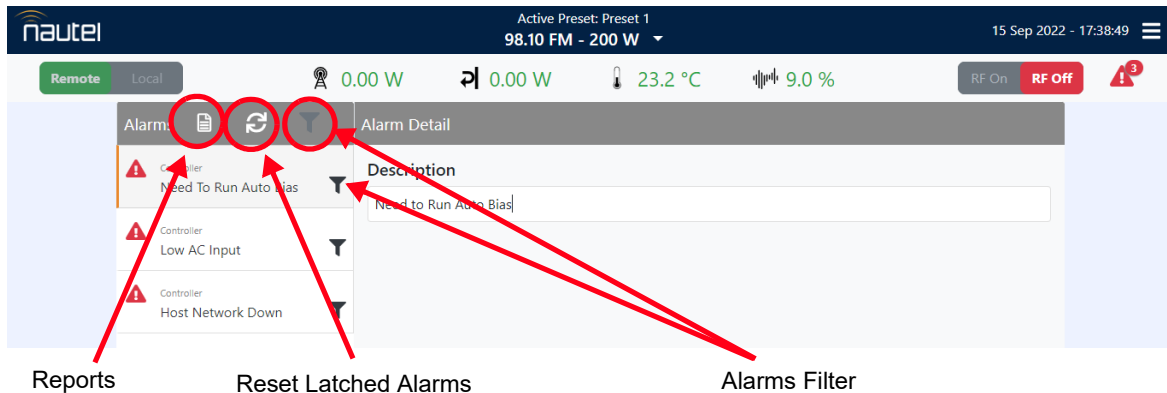

The Alarms page displays all active transmitter alarms. Alarms are listed by their host device (Controller or Exciter) and alarm name. Refer to the VX150 to VX2 Troubleshooting Manual for detailed information on alarm details such as root cause and troubleshooting tips.

Click the Reset Latched Alarms icon at the top, left of the Alarms screen to attempt to clear any latching alarms that are holding the transmitter in an "off-air" state. If the offending alarm has cleared, the transmitter should resume operation.

Click the Reports icon at the top, left of the Alarms screen to go to the Reports screen where the user can see or download the event history. See [Reports on page 2.2.77](#).

The Alarms Filter icons allow you to hide alarms that you do not want to see. To hide a specific alarm click its alarms filter icon. To toggle hide/show for hidden alarms click the filter icon next to the Reset Latched Alarms icon.

Meters

The meters displayed in the AUI represents the active meters for the transmitter and displays a real-time value.

Open the Meters window to view all the transmitter’s meters (see [Figure 2.2.17](#)).

Meters can also be added to the Dashboard as a display panel. See [Dashboard Meters on page 2.2.20](#).

You can also view meters using the local front panel UI (see [Meters on page 2.2.94](#)). See [Table 2.2.3 on page 2.2.27](#) for a detailed list of all the transmitter’s meters.

NOTE: Meter values get updated typically every one or two seconds.

Figure 2.2.17: Meters

The screenshot shows a window titled "Meter Detail" with a blue "All" button. Below the button is a table with 11 rows of meter data. The table has two columns: the meter name and its current value.

Meter Name	Value
AAB -8V	-8.33 V
AAB +12V	12.1 V
AAB +5V	5.03 V
AAB +8V	8.11 V
AES 1 DMPX	N/A
AES 1 Left	N/A
AES 1 Right	N/A
AES 2 DMPX	N/A
AES 2 Left	N/A
AES 2 Right	N/A

Partial Meter List shown for reference

Table 2.2.3: Meters List

AAB -8V	IPA Current	+12 V
AAB +12V	IPA Voltage	+2.5 V
AAB +5V	Peak Modulation Level	+3.3 V
AAB +8V	MPX 1	+5 V
AES 1 DMPX	MPX 2	PPS Delta
AES 1 Left	MPX RMS	PA A Input Voltage
AES 1 Right	PA 1 Bias Voltage	Reflected RMS Power
AES 2 DMPX	PA 1 Current	RF Drive Power
AES 2 Left	PA 1 Dissipation	SIB 1 Ambient Temperature
AES 2 Right	PA 1 Voltage	SIB 1 +12 V
Analog Left	PA 2 Bias Voltage	SIB 1 +3.3 V
Analog Right	PA 2 Current	Total DC Current
Average PA Voltage	PA 2 Dissipation	User RF Output Power
DAC Gain Scaler	PA 2 Voltage	VSWR
DC-RF Efficiency	PA Heatsink Temperature	Fan 1 Speed
DSP Temperature	+1.1 V	Fan 2 Speed
IPA1 Bias Voltage	+1.5 V	

Presets

This section includes the following subjects:

- [Managing Presets - Using the AUI](#)
- [Activating presets using the AUI - see page 2.2.28](#)
- [Editing or creating presets using the AUI - see page 2.2.29](#)
- [Scheduler - see page 2.2.46](#)

Presets contain operational data (power, frequency, mode, program inputs) for the transmitter. You can create and manage presets using the remote AUI (see [Managing Presets - Using the AUI](#)).

Managing Presets - Using the AUI

The Presets page (see [Figure 2.2.18](#)) allows you to create up to 62 operating presets or edit existing presets. To view the Presets page, select Presets from the Dashboard menu or click on the Active Preset in the top banner. Many preset settings available on the remote AUI are also available on the front panel UI. In this case, if you change a preset setting on the remote AUI, it will also be reflected on the front panel UI, and vice versa.

Figure 2.2.18: Presets page

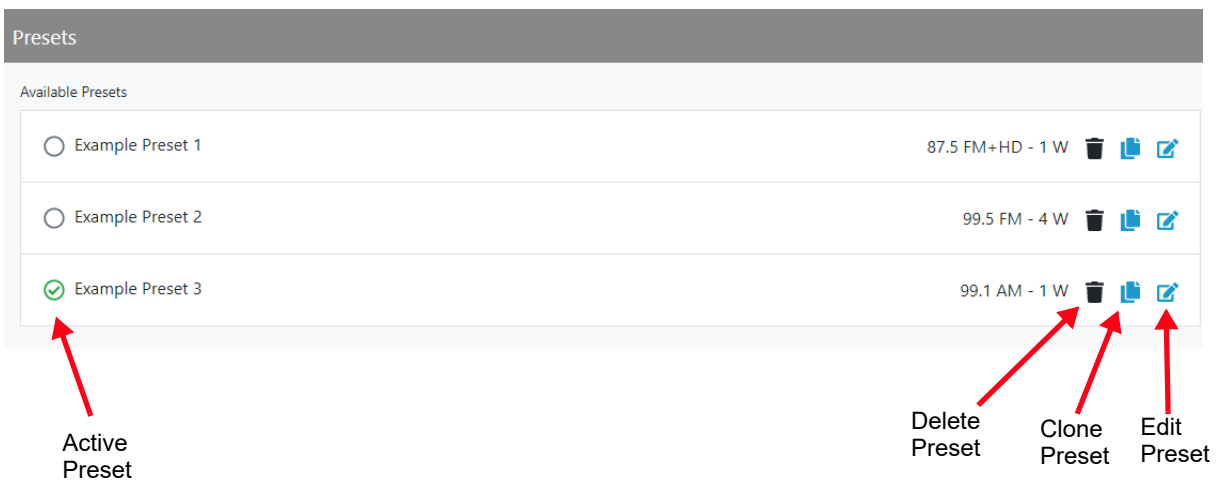

Activating presets using the AUI

There are two ways to activate a preset using the AUI:

- Click the Active Preset section in the top banner of any AUI page
- Enter the Presets page from the Dashboard.

Both methods will indicate the current active preset, by a green check mark next to its radio button (e.g., Example Preset 3, see [Figure 2.2.18 on page 2.2.28](#)). If the current preset is not the desired one, click the radio button of the desired preset in the Available Presets list, or create a new preset or clicking the Clone Preset button and edit the preset.

If you select an alternate active preset, a confirmation prompt will appear. Select Close to cancel or Continue to activate the selected preset. Press the Delete button to delete the selected preset. Users cannot delete the current "active" (operational) preset or any preset that is referenced in the Remote I/O menu as either a remote input or output. Those links in the Remote I/O menu must be deleted before the associated preset can be deleted. Press Cancel to return to the Presets page.

Editing or creating presets using the AUI

When a presets page is opened from the main menu, the operational settings of the transmitter are displayed. They define the current operational state of the transmitter. Operational settings can be edited and then immediately activated by pressing the Save button.

Any preset can be renamed, regardless of the transmitter status, using the Edit function and saving the changes.

To edit a saved preset, you must load that preset from the Presets page (see [Editing or creating presets using the AUI on page 2.2.29](#)). Editing the active preset will immediately update the transmitter's operational settings.

NOTE: When editing saved User presets, the best practice is to load a preset that is close to the desired configuration and then adjust its settings for the exact configuration.

In the Presets screen or top banner (see [Figure 2.2.18 on page 2.2.28](#)), a green checkmark appears next to the preset name to indicate which is the active preset.

When changes are complete, press the Save button.

Parameters that can be edited are discussed in detail below.

To remove a preset, select it and press the Delete button.

NOTE: If only one preset is available, assigned in the Preset Scheduler or assigned in Remote I/O, it cannot be deleted.

When editing saved User presets, the best practice is to load a preset that is close to the desired configuration and then adjust its settings for the exact configuration.

To ignore any changes, press Cancel to return to the Presets screen.

General

See [Figure 2.2.19](#).

Figure 2.2.19: General page

The screenshot shows the 'Update Preset' dialog box with the 'General' tab selected. The dialog has a title bar 'Update Preset' and a tabbed interface with 'General', 'Audio', 'SCA', 'RDS', and 'Other Settings'. The 'General' tab contains the following fields:

Field	Value	Unit
Preset Name		Preset 1
Output Power	100	W
Frequency	98.1	MHz
Mode		FM

At the bottom right of the dialog are 'Cancel' and 'Save' buttons.

- **Preset Name:** This field identifies the name of the current preset. Users can rename the default preset name in the Edit Preset menu.
- **Output Power:** Sets the output power level (in W). Use the up and down arrows or enter the numerical value to adjust the power level. Output power limits are a function of the transmitter mode of operation (see Section 1.1 of the Installation Manual for RF output power ratings for this transmitter).
- **Frequency:** Set value. Valid frequencies are between 87.50 and 108.00 MHz.
- **Mode:** Set the overall transmission mode. Available options are:
 - FM: an analog only mode, transmits a carrier, frequency modulated with audio.

NOTE: Settings on the Presets tabs are shown/hidden based on the chosen settings. Not all settings are available in all modes.

Audio

The Audio page (see [Figure 2.2.20](#)) includes settings for both the main and backup (if applicable) audio sources. The Main Audio settings are always displayed, and Backup Audio Source settings are shown when the Backup Audio Source is enabled.

Figure 2.2.20: Audio page

Update Preset	
General Audio SCA RDS Other Settings	
Main Audio	
Audio Source	Analog L/R
Audio Mode	Stereo
Analog Level	0 dBu
15 kHz Low-Pass	Disabled
Pre-emphasis	0 μs
Low Audio Alarm	Disabled
Backup Audio Source	
	None
<input type="button" value="Cancel"/> <input type="button" value="Save"/>	

- Audio Source: Select from AES1/2, MPX1/2, DMPX AES1/2 or Analog L/R.

NOTE: The allowable range of audio source selections will vary depending on which audio input sources are already occupied. For example, if a preset's main audio source is set to AES1 in Left Mono mode, then the same preset's internal SCA1 source cannot be set to AES1 Left.

- Audio Mode: Applies to Analog Left/Right and AES1/2 sources only. Select Mono L, Mono R, Mono L+R or Stereo (selecting Stereo applies a 19 kHz pilot).
- Analog Level: Applies to Analog Left/Right sources only. Enter value between -12 and +12 dBu, which represents the input voltage level that yields 100% modulation (Default is 0.0 dBu).
- 15 kHz Lowpass: Applies to AES1/2 sources only. Select Enabled (applies 15 kHz low-pass filter to audio input) or Disabled.

- Preemphasis: Applies to Analog Left/Right and AES1/2 sources only. Select 0 us, 50 us or 75 us.
- MPX Level: Applies to MPX1/2 sources only. Set this parameter level in Vpp (typically 3.5 Vpp - 100% modulation value). The allowable range for this setting is between 1-5 Vpp.
- Digital or DMPX Level: Applies to AES1/2 and DMPX AES1/2 sources only. Enter value between -25.0 and 0 dBFS, with a typical setting of -4 dBFS (100% modulation value).
- Low Audio Alarm: When enabled, you can select the Low Audio Alarm Threshold and the Low Audio Alarm Timeout. The Low Audio Alarm only applies to the main audio source's level. The backup audio source, if enabled and present, will replace the main audio source if the main audio level is less than its user-determined trip threshold (see [Main Audio on page 2.2.106](#)). The main audio source will be restored as the active source if it returns and is present for at least one second.
- Backup Audio Source: When a backup audio source type is selected (i.e., enabled), you can select a backup audio source and edit various parameters for the backup audio similar to the main audio described above. The backup audio source, if enabled and present, will replace the main audio source if the main audio level is less than its user-determined trip threshold (see Low Audio Alarm above). The main audio source will be restored as the active source if it returns and is present for at least one second.

NOTE: Backup Audio will only be used if the Main Audio's Low Audio Alarm is enabled.

NOTE: If you edit and save the Backup Audio settings after the transmitter switches over to the backup audio source due to a main audio source failure, the transmitter will switch back to the main audio source. If the main audio source is still in a failure state, the transmitter will switch back to the backup audio source, after the selected timeout period.

SCA

See [Figure 2.2.21](#).

Figure 2.2.21: SCA page

Update Preset

General
SCA
RDS
Other Settings

SCA MPX 1 Input	<input type="text" value="MPX 1"/>	MPX 1 ▾
SCA MPX 1 Analog Level	3.5 ▾	Vpp
SCA MPX 1 Main Carrier Reduction	0 ▾	%
SCA MPX 1 Low Alarm	<input type="text" value="Enabled"/>	Enabled ▾
SCA MPX 1 Low Alarm Threshold	1 ▾	Vpp
SCA MPX 1 Low Alarm Timeout	20 ▾	s
SCA MPX 2 Input	<input type="text" value="None"/>	None ▾
SCA 1 Input	<input type="text" value="AES 1"/>	AES 1 ▾
SCA1 Injection Level	10 ▾	%
SCA1 Frequency	67 ▾	kHz
SCA 1 Digital Level	-4 ▾	dBFS
SCA 1 Low-Pass	<input type="text" value="Disabled"/>	Disabled ▾
SCA1 Pre-emphasis	<input type="text" value="0"/>	0 ▾
SCA1 Mode	<input type="text" value="FM"/>	FM ▾
SCA 1 Low Alarm	<input type="text" value="Enabled"/>	Enabled ▾
SCA 1 Low Alarm Threshold (Digital)	-20 ▾	dBFS
SCA 1 Low Alarm Timeout	20 ▾	s
SCA 2 Input	<input type="text" value="None"/>	None ▾

Cancel
Save

NOTE: Check your local broadcast regulatory body’s guidelines for allowable modulation depth with SCAs or RDS enabled.

-
- SCA MPX1/2 Input: Connectors for use with an externally generated SCA; when MPX 1 or MPX 2 is selected (i.e., enabled), all the selections listed below are active for the selected SCA MPX input.
 - SCA MPX 1/2 Analog Level: signal level that represents 10% modulation. Enter a value between 1 and 5 V p-p (typically 3.5 Vpp).
 - SCA MPX 1/2 Main Carrier Reduction: Attenuation applied to the SCA input; set between 0 and 20% (used to reduce the modulation level of the main audio when SCAs are enabled; typically, for every 2% of SCA modulation, the main audio modulation must be reduced by 1%)
 - SCA MPX 1/2 Low Alarm: When enabled, you can select the SCA MPX 1/2 Low Alarm Threshold and the SCA MPX 1/2 Low Alarm Timeout. The Low Alarm only applies to the main audio source's level and no further action is taken on them after their respective alarms are triggered.

 - SCA1/2 Input: Enable or disable the appropriate internal SCA (SCA1 or SCA2). When set to an audio input, internal SCA generators can use AES or Analog, the settings listed below are active for the associated SCA signal (1 or 2).
 - SCA1 or SCA2 Injection Level: enter value between 0 and 20% (typically 10%); this level is added to the composite baseband signal.
 - SCA1 or SCA2 Frequency: enter value between 20 and 100 kHz (typically set to 67 kHz or 92 kHz).
 - SCA1 or SCA 2 Analog Level (when SCA 1/2 Input is Analog Left or Right): enter value between -12 and +12 dBu, which represents the input voltage level that yields 10% modulation (typically 0.0 dBu).
 - SCA1 or SCA 2 Digital Level (when SCA 1/2 Input is AES 1 or 2): enter value between -25 and 0 dBFS, which represents the input voltage level that yields 10% modulation (typically -4.0 dBFS).
 - SCA1 or SCA2 Lowpass: select Enabled (applies 7.5 kHz low-pass filter to audio input) or Disabled.
 - SCA1 or SCA2 Pre-emphasis: select 0 us, 50 us or 75 us.
 - SCA1 or SCA2 Mode: select FM (frequency modulated sub-carrier, typical).

RDS

For RDS operation, an external unit or software can send data to the exciter, serially or over IP. The exciter generates the RBDS/RDS carrier and injects the data; externally generated, or alternatively, the Presets page offer a means to configure internally generated data. Select Enabled from the drop-down menu and click Save. See [Figure 2.2.22](#).

Figure 2.2.22: RDS page

Update Preset	
General Audio SCA RDS Other Settings	
RDS	Enabled
PI Code	1 hex
Data Source	Internal RDS
Injection Level	5 %
Phase	0 °
PS Name	PS Name
Scrolling Enable/Speed	Off
Scrolling PS Name	Scrolling PS Name
Scrolling Type	Character
Radio Text	Radio Text
PTY	0: NONE/NONE
PTYN	PTYN
Music/Speech	Music
Traffic Info	None
Alternate Frequencies	0
Artificial Head	Disabled
Compression Flag	Disabled
Dynamic Pty	Disabled
DI Stereo	Disabled

Refer to [RDS Remote Protocol](#), on page 2.2.39 for information on using the ASCII protocol to remotely configure RDS settings and to observe the strings supported by Nautel.

NOTE: The UECP protocol is fully supported.

NOTE: The differences between RDS (European) and RBDS (North American) are not part of this manual. Presets created using the VX150 to VX2 are compatible with either type.

- RDS: Select Enabled or Disabled (default is Disabled). When enabled, all of the selections below are active.

NOTE: When using the internal data source, you must correctly enter all RDS fields - specifically PI Code or PS Name - to ensure proper reception of RDS information.

- PI Code (hex) (Program Identification code): Enter four hex digits that represent the station call sign (e.g., PI=1AE5); this unique code is used to identify a broadcast station. Each station gets assigned a specific code with a country identifying prefix. In the USA the code is determined by applying a formula to the station's call sign (see www.nrcsstandards.org). In Canada the code is determined using the Spectrum Management and Telecommunications tool found at www.ic.gc.ca. Contact your local broadcast regulatory body for details on determining your unique PI Code.
- Data Source: Select Internal, Ext_ASCII, UECP, IP_ASCII or IP_UECP.

NOTE: For ASCII over IP data or UECP over IP data, send RDS information to the IP address of the VX150 to VX2, port 7005. Also note that the IP data is TCP/IP format, not UDP.

- Injection Level: Enter value between 0 and 10% (default is 5%). This level is added to the composite baseband signal.
- Phase: enter value in degrees between 0 and 360 (default is 0.0 degrees).
- PS Name (programme service name): This is simply a maximum 8-character "tagline" static display that represents the call letters or station identity name. Most RDS capable receivers display this information and, if the station is stored in the receiver's presets, will cache this information with the frequency and other details associated with that preset. Default is blank.
- Scrolling Enable/Speed: Determines the scrolling speed of the Scrolling PS Name. Select Off (disabled), Slow (transitions every 10 s) or Fast (transitions every 3 s). Default is Off.
- Scrolling PS Name: If used, enter up to 64 characters for the PS name that will scroll (if enabled) at the speed selected in the Scrolling Enable/Speed field. Information is displayed on the receiver based on transmitter configuration; however, is limited to 8 characters maximum. Default is blank.

NOTE: Words are defined by the spaces in the Scrolling PS Name. Words that exceed 8 characters will scroll each character until the entire word is displayed, then continue with the next word.

-
- Scrolling Type: Select the type of scrolling to be used by the receiver - Word or Character. Word scrolling displays and transitions a maximum of 8 characters of the Scrolling PS Name at a time. Character scrolling still displays a maximum of 8 characters; however, transitions by one character of the Scrolling PS Name at a time. In both cases, transitions occur at the speed defined by the Scrolling Enable/Speed selection (Slow or Fast). The default selection is Word.
 - Radio Text: Most RDS radios can receive short messages that may include information about the presenter, station or program you are listening to (e.g., a web address for the station). You can enter radio text up to 64 characters in length. Information is displayed on the receiver based on the receiver configuration and capability (e.g., maximum number of characters on the screen). Default is blank.
 - PTY: this coding of up to 32 (0 to 31) pre-defined programme types allows users to find similar programming by genre. Default is 0: NONE/NONE.
 - PTYN (programme type name): This field can be used for detailed description of the PTY by 8 digits. Example: if the PTY is 4 (Sport) a PTYN like "Football" could be transmitted. The PTYN is intended for displaying additional information only cannot be used for automatic station turning like the PTY. The PTYN is optional. Default is blank.
 - Music/Speech: Select Music or Speech. Default is Speech.
 - Traffic Info: Select None, TA (Traffic Announcement), TP (Traffic Programme) or TA+TP. The receiver can often be set to pay special attention to this flag and, for example, stop the tape/pause the CD or re-tune to receive a traffic bulletin. The TP flag is used (set to 1) to allow the user to find only those stations that regularly broadcast traffic bulletins whereas the TA flag is used (set to 1) to signal an actual traffic bulletin in progress. These flags are set to 0 if they are not being used for traffic information. Default is None.
 - Alternate Frequencies: Select None or 1 through 25. This allows a receiver to re-tune to a different frequency providing the same station information (i.e., using translators or repeaters) when the first signal is too weak. This is often utilized in car stereo systems. Default is None.
 - Artificial Head (bit 1 of DI, see NOTE below): select Enabled or Disabled. This selection is a decoder identification operating mode flag. Default is Disabled.
 - Compression Flag (bit 2 of DI, see NOTE below): Select Enabled or Disabled. This selection is a decoder identification operating mode flag. Default is Disabled.
 - Dynamic PTY (bit 3 of DI, see NOTE below): Select Dynamic or Static. This selection is a decoder identification operating mode flag. Default is Static.

- DI Stereo: (bit 0 of DI, see NOTE below): select Stereo or Mono. This selection is a decoder identification operating mode flag. Default is Mono.

NOTE: Artificial Head, Compression Flag, Dynamic PTY and Stereo are part of the DI (Decoder Information) data (see UI editing screens on [Figure 2.2.86 on page 2.2.113](#)). RDS Data is provided as a single-digit hex input between 0 and F, that encodes the flags for the four settings as a 4-bit code. For example: hex number 3 is bit-represented by 0011, from bit 3 on the left to bit 0 on the right. This number is decoded to mean Stereo = Yes/Stereo (bit 0=1), Artificial Head = Yes/Enabled (bit 1=1), Compression = No/Disabled (bit 2=0) and Dynamic PTY = No/Static (bit 3=0).

NOTE: Artificial Head, Compression Flag, Dynamic PTY and Stereo are part of the DI (Decoder Information) data (see UI editing screens on [Figure 2.2.86 on page 2.2.113](#)). RDS Data is provided as a single-digit hex input between 0 and F, that encodes the flags for the four settings as a 4-bit code. For example: hex number 3 is bit-represented by 0011, from bit 3 on the left to bit 0 on the right. This number is decoded to mean Stereo = Yes/Stereo (bit 0=1), Artificial Head = Yes/Enabled (bit 1=1), Compression = No/Disabled (bit 2=0) and Dynamic PTY = No/Static (bit 3=0).

- Baud Rate: (displayed only when Data Source is ASCII over Serial or UECP over Serial): Select 150, 300, 600, 1200, 2400, 4800, 9600, 19200, 38400, 57600 or 115,200 bps (default is 19200). Does not apply to the Internal data source.
- Local Echo (displayed only when Data Source is ASCII over Serial). Select Enabled or Disabled (default is Disabled). When Enabled, the exciter RDS port transceiver will echo all inputs and controls received back to the terminal.

RDS Remote Protocol. The following information is intended to assist users with remote RDS settings using the ASCII protocol.

Assigning Settings: To assign a value to a setting, send the setting name, the equal sign (=) and the desired value. If the setting is valid, the exciter responds "OK". If the setting is invalid, the exciter responds "NO".

```
Examples: PI=1248 //set the PI code to 0x1248
          OK      // exciter responds with OK
          TA=2    // set the traffic announcement to 2 (bad command; only values 0 or 1 allowed)
          NO      // exciter responds with NO
```

Querying Settings: To determine the current value of a setting, type the setting name with a question mark (?) instead of an equal sign (=).

```
Examples: PI?      //query the current PI code
          1248     // exciter responds with "1248", the current PI code
```

Other Considerations:

Initial Values and Preset Changes

On startup, or when the RDS settings in the active preset differ from the last ones loaded, the preset's initial RDS settings (PS, PI, PTY, PTYN, RT, AF, etc.) will be loaded. If there is an active data source (UECP or ASCII via serial or IP), these settings may be updated externally.

The RDS settings from the preset will only be loaded again if they change, otherwise the working set from the external data source will continue to be used. This allows unrelated preset changes to adjust other settings without affecting RDS functionality.

Real Time Clock

The Exciter/Control PWB has a super capacitor backed real-time clock that keeps track of the time and date if configured for ASCII or UECP.

After every power failure, the transmitter checks if the super capacitor is fully discharged and the real-time clock stopped. If it has stopped, then an Invalid Date & Time alarm will be present. As long as this alarm is active, the RDS generator will not broadcast the time and date regardless of any commands given via the UECP or ASCII protocols to enable it. It is possible to clear the alarm by setting the correct time, either using the ASCII or UECP protocols, or using the AUI or FPUI, or by enabling NTP if the transmitter has an always-available TCP/IP connection to a compatible time server.

TCP Usage

Use TCP port 7005. This is not user configurable. To use RDS over IP, the connection must be opened before each command.

[Table 2.2.4](#) lists the RDS settings supported by Nautel, including descriptions and examples.

NOTE: Remote setting of the RDS baud rate is not supported.

Table 2.2.4: RDS Settings

Setting	Name	Description/Example
PI=	Program Identification	Four hex digits representing the station call sign. Consult the RDS/RBDS specification for more information. Example: PI=1AE5
PS=	Program Service	Maximum 8-character ASCII "tagline" string describing the radio station. Example: PS=Q104-FM
PTY=	Program TYpe	Number, from 0 to 31, describing the station format. Example: PTY=24
PTYN=	Program TYpe Name	8-character ASCII string, also describing the station format. Example: PTYN=JAZZ24-7
TP=	Traffic Program	Set to 1 if the current program sometimes carries traffic information, otherwise set to 0. Example: TP=1
TA=	Traffic Announcement	Set to 1 if the current program is currently broadcasting a traffic announcement, otherwise set to 0. Example: TA=0 NOTE: Timeout of the TA flag is not implemented, so the RDS data source should ensure this flag is properly cleared.

Setting	Name	Description/Example
AF1= ... AF25=	Alternative Frequency	<p>If the station broadcasts on more than one frequency using translators or repeaters, these are typically set to each of the frequencies used in the broadcast network.</p> <p>Sample calculation for 98.5 MHz: $(98.5-87.5) \times 10 = 110$</p> <p>Example: AF1=110 NOTE: there is no method to disable AFs in this protocol.</p>
DI=	Decoder Information	<p>Single hex digit, range 0-9 and A-F (case insensitive) that encodes the flags Stereo(1)/ Mono(0) - bit 0; Artificial Head (Yes=1, No=0) - Bit 1; Compression (Yes=1, No=0) - Bit 2; and Dynamic (Yes=1, No=0) - Bit 3</p> <p>Example: DI=3 (Stereo, Artificial Head=Yes, Compression=No, Dynamic=No)</p>
MS=	Music/Speech	<p>Typically set to 1 if the station broadcasts music, otherwise set to 0.</p> <p>Example: MS=1</p>
TEXT=	Radio Text	<p>Accepts a 1 through 64 character ASCII string, displayed on receivers that support RDS radio text.</p> <p>Example: TEXT=Tears for Fears - Shout (1985)</p>
ECHO=	Echo on/off	<p>If set to 1, the RDS encoder will echo back characters that are sent to it. If set to 0, the encoder will only send responses.</p> <p>Example: ECHO=1</p>
DATE=	Current UTC date	<p>Format is strictly YYYY-MM-DD. Sets the current UTC date for 4A date/time broadcasts. This is a non-volatile setting.</p> <p>Example: DATE=2016-04-04</p>
TIME=	Current UTC time	<p>Format is strictly HH:MM:SS, 24-hour format. Sets the current UTC time for 4A date/time broadcasts. This is a non-volatile setting.</p> <p>Example: TIME=17:23:05</p>
UTC=	UTC time zone offset	<p>Range is 0 to 24, 32 to 56. Sets the current time zone. To calculate this value, multiply the time offset by 2 and add 32 if the time offset is negative. For Newfoundland (UTC-3.5), $3.5 \times 2 = 7$, and add 32 (since the time zone is negative) to yield 39. This is a non-volatile setting.</p> <p>Example: UTC=39</p>

Setting	Name	Description/Example
CT=	4A date/time enable	If set to 1, the exciter will broadcast a 4A RDS packet on the edge of every minute with the currently set UTC time/date. This is a volatile setting. Example: CT=1
DPS=	Dynamic Program Service (scrolling command)	64-character ASCII string typically describing the radio station. Example: DPS=Q104-FM The Home of Rock N Roll
DPSR=	Dynamic Program Service Rate (scrolling command)	Number, from 0 to 2, describing the scrolling rate. 0 is off (default); the PS= command is displayed when DPSR=0 is used. 1 is slow; the DPS string will scroll at a rate of approximately 10 s. 2 is fast; the DPS string will scroll at a rate of approximately 3 s. Example: DPSR=2
DPSM=	Dynamic Program Service Mode (scrolling command)	Number, 0 or 1, describing the scrolling mode. 0 is word-scrolling; the DPS string will scroll word by word, or multiple words when they fit. 1 is character-scrolling; the DPS string will scroll character by character. Example: DPSM=0
REV	Software Version (special command)	Typing this command (no = or ?) returns the current RDS encoder software version. Example: REV // issue version command Nautel NVE RDS Encoder V1.0 // exciter response

Other Settings

Figure 2.2.23: Other Settings page

Update Preset

General
Audio
SCA
RDS
Other Settings

Pilot Level	9 <input type="text"/>	%
Pilot 1PPS Sync	<input type="text"/>	Enabled <input type="button" value="v"/>
Pilot Sync Phase	0 <input type="text"/>	°
Audio Delay	<input type="text"/>	Enabled <input type="button" value="v"/>
Audio Delay Value	0 <input type="text"/>	s
Mod Loss Timeout	<input type="text"/>	Enabled <input type="button" value="v"/>
Mod Loss Action	<input type="text"/>	Alarm Only <input type="button" value="v"/>
Mod Loss Timeout Minutes	2 <input type="text"/>	min
Mod Loss Timeout Seconds	30 <input type="text"/>	s
Mod Loss Threshold	50 <input type="text"/>	%
Hard Limiter	<input type="text"/>	Enabled <input type="button" value="v"/>
Hard Limit Value	100 <input type="text"/>	%
AGC Limiter	<input type="text"/>	Enabled <input type="button" value="v"/>
AGC Limit	100 <input type="text"/>	%
AGC Time Constant	300 <input type="text"/>	ms
L/R Limiter	<input type="text"/>	Enabled <input type="button" value="v"/>
L/R Max Gain	0 <input type="text"/>	dB
L/R Decay Time	0 <input type="text"/>	s
L/R Hold Time	0 <input type="text"/>	s
MPX Power Limiter	<input type="text"/>	Enabled <input type="button" value="v"/>
MPX RMS Limit	0 <input type="text"/>	dBr
Orban Processor	<input style="border: 2px solid #00aaff;" type="text"/>	Enabled <input type="button" value="v"/>
Orban Preset	<input type="text"/>	BASS-PUNCH <input type="button" value="v"/>

-
- Pilot Level: enter value between 6 and 12% (typically 9%); this level is added to the composite baseband.
 - Pilot 1 PPS Sync: select Enabled or Disabled. If Enabled, enter:
 - Pilot Sync Phase: (enter value between 0 and 360 degrees; typically 0 degrees).
 - Audio Delay: Used to time align the receiver output of decoded analog and digital audio signals. Select Enabled or Disabled. If Enabled, enter:
 - Audio Delay Value: enter value between 0 and 20 seconds (default is 0).
 - Mod (Modulation) Loss Timeout: select Enabled or Disabled. If Enabled, enter:
 - Mod Loss Action: None (alarm only, no resulting action), Inhibit (inhibits the RF output until the audio returns) or Change Preset (changes the active preset).
 - Mod Loss Preset: displayed only if Action is set to Change Preset. Select the preset from the drop down list that will activate upon the loss of a modulating signal, post the timeout period. The original preset will not automatically return as the active preset if the audio/modulation recovers. Manually re-select the active preset is required.
 - Mod Loss Timeout Minutes: sets the delay, in minutes, between modulation loss detection and the resulting action. Enter a value in the allowable range of 0 and 255 minutes.
 - Mod Loss Timeout Seconds: sets the delay, in seconds, between modulation loss detection and the resulting action. Enter a value in the allowable range of 0 and 59.9 seconds.
 - Mod Loss Threshold: sets the threshold for modulation loss detection. Enter a value in the allowable range of 0 and 100% (default is 0%). This feature uses the MPX baseband/peak modulation level which includes RDS and SCA signals.
 - Hard Limiter: If enabled, the modulation level will be limited (audio signal clipped or distorted) if it exceeds the hard limit threshold. Select Enabled or Disabled. If Enabled, enter:
 - Hard Limit Value: enter value between 0 and 160% (default is 160%).

NOTE: The RDS and Pilot signals are added to the RF output after the Hard Limiter is applied. This could result in the output modulation exceeding the Hard Limiter threshold.

- AGC Limiter: If Enabled, when the modulation level exceeds the AGC Limit, the gain of the audio input will instantly decrease in order to reduce the modulation level below the AGC limit threshold. Recovery from this audio gain reduction is dependent on the Time Constant delay (fast attack, slow recovery). The input signal is briefly distorted by the audio gain reduction when the threshold is exceeded. Select Enabled or Disabled. If Enabled, enter:

- AGC Limit: enter value between 0 and 160% (default is 120%).
- AGC Time Constant: enter value between 0 and 1000 ms (default is 300 ms).
- L/R Limiter: This look-ahead limiter can be applied to the signal immediately before the stereo generator in the exciter. It has a fixed attack-time (and corresponding delay) of approximately 1 s. It can be configured to reduce the signal, if the gain setting is 0 dB or less, or can be used to perform an AGC function and boost quiet sections of the audio if a positive gain setting is used. If Enabled, enter the following parameters:
 - L/R Hold Time: enter value between 0 and 60 s (default is 5 s).
 - L/R Decay Time: enter value between 0 and 60 s (default is 5 s).
 - L/R Max Gain: enter value between -30 and 30 dB (default is 12 dB).
- MPX Power Limiter: If Enabled, enter MPX RMS Limit. This limit allows the broadcast signal to remain in compliance with the MPX power limits as suggested in ITU-R BS.412-9. While the limiter will keep the transmitter in compliance, it is recommended that adjustment to the processing be made in such a way to minimize the reductions performed by the limiter. Otherwise the signal will not take advantage of the peak modulation capability available.
 - MPX RMS Limit: enter value between -12 and 12 dBr (default is 0 dBr).
- Orban Processor: select Enabled or Disabled. If Enabled, enter:
 - Orban Preset: select one of the 27 factory Orban presets from the dropdown menu or create a new Orban Preset from an existing factory preset. See [Audio Processing on page 2.2.49](#) for details on creating custom presets.

NOTE: The Orban Audio Processor is an optional item.

Scheduler

You can program a preset schedule for the transmitter. Select Preset Scheduler from the Settings page in the Dashboard menu (see [Figure 2.2.24](#)) to set the dates and times at which presets take effect. You can define up to 63 different schedule rules. The Scheduler can also be set using the Front Panel UI (see [Enable Scheduler on page 2.2.140](#)).

Figure 2.2.24: Scheduler page

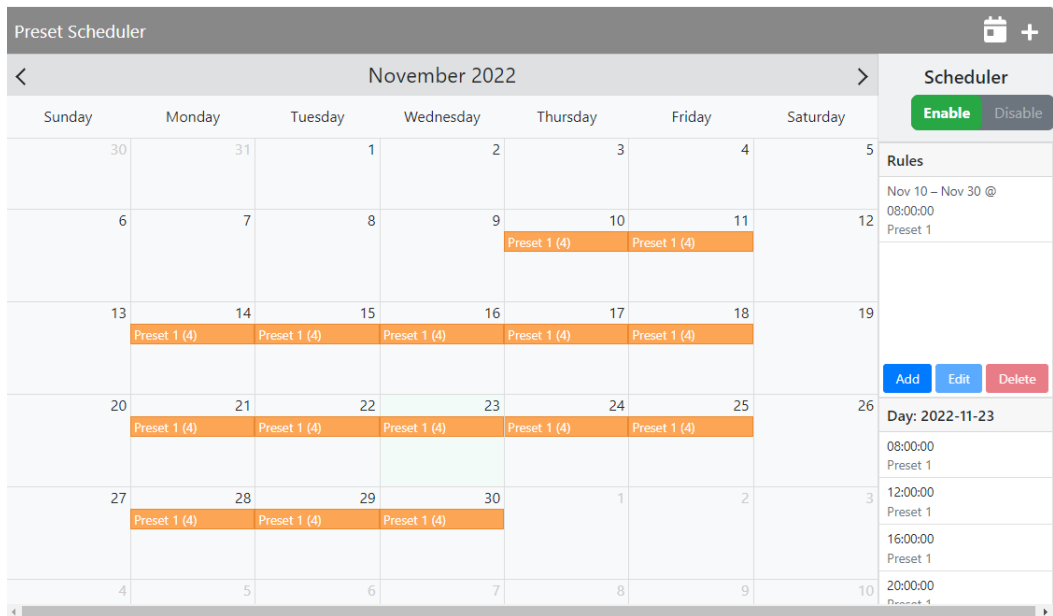

The Scheduler page displays a monthly calendar (e.g., September 2020). Use the < and > buttons to navigate between months.

By clicking on a specific date in the monthly calendar displays the Edit Rule page which contains the Timeframe, Days of the Week, and Time parameters, as applicable, for that day.

When in the Edit Rule list, you have the option to edit or delete an existing rule, or to create a new rule. Click the New or Edit button to display the Rule Explorer window (see [Figure 2.2.25 on page 2.2.47](#)). Click Delete to remove a rule from the list.

Use the Edit Rule window as follows:

- Use the drop-down menu to select the preset (e.g., Example Preset 1) for the rule. The preset's power, mode and frequency are displayed below the preset.
- In the Timeframe section, set the start (From:) and end (To:) dates for the rule. Start to end dates must be less than one year apart.

- In the Days of the Week section, select the days of the week on which the rule will apply.
- In the Time section, set the start (From:) and end (To:) times (hours and minutes) for the rule. Use the Repeat: field to establish a repeating cycle for the rule (e.g., every 24 hours).
- Unless you edit other rules first, you cannot select a date that occurs before the start of the previous rule or after the start of the following rule.
- Click the Save button to store the rule in the scheduler, the Cancel button to return to the Scheduler page or the Delete button to delete the rule.

When Scheduler: OFF appears, the transmitter will stop following the schedule and the active preset will be the preset that was operating when the scheduler was disabled.

Figure 2.2.25: Edit Rule page

The screenshot displays the 'Edit Rule' configuration page. It is divided into several sections:

- Presets:** A dropdown menu showing 'Example Preset 1'.
- Timeframe:** Two date pickers. 'From' is set to 'January 1' and 'To' is set to 'November 1'.
- Days of Week:** A list of days with checkboxes. Monday, Wednesday, and Friday are selected.
- Time:** Two time pickers. 'From' is set to '06:00' and 'To' is set to '16:00'.
- Repeat Every:** A text input field containing '02:00'.
- Self Delete:** An unchecked checkbox.
- Preview:** A vertical calendar grid showing time slots from 00:00 to 24:00. Orange horizontal lines indicate the active rule periods from 06:00 to 16:00 on the selected days.
- Buttons:** A red 'Delete' button, a blue 'Save' button, and a grey 'Cancel' button are located at the bottom.

Settings

The Settings menu (see [Figure 2.2.26 on page 2.2.48](#)) contains the following features:

- Audio Processing (see [Audio Processing - see page 2.2.49](#))
- Exciter VCXO (see [Exciter VCXO - see page 2.2.52](#))
- External 10 MHz (see [External 10 MHz - see page 2.2.53](#))
- Network (see [Network - see page 2.2.54](#))
- Notifications (see [Notifications - see page 2.2.56](#))
- Security Certificates (see [Security Certificates - see page 2.2.59](#))
- SNMP (see [SNMP - see page 2.2.60](#))
- Spectrum Mask (see [Spectrum Mask - see page 2.2.62](#))
- System Preferences (see [System Preferences - see page 2.2.63](#))
- Thresholds (see [Thresholds - see page 2.2.63](#))
- Time (see [Time - see page 2.2.64](#))
- Transmitter Info (see [Transmitter Info - see page 2.2.66](#))
- Users (see [Users - see page 2.2.67](#))

Figure 2.2.26: Main Menu - Settings

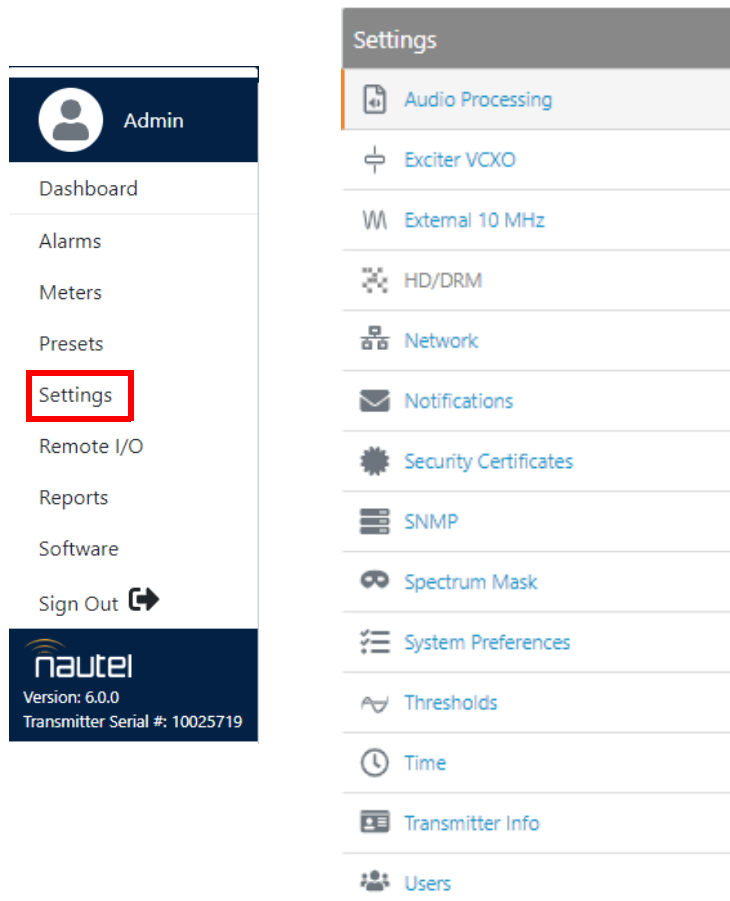

NOTE: For consistency, the Settings menu is the same for all transmitter series. If a transmitter does not have a feature, such as Audio Processing or HD/DRM, that menu option is greyed out in the Settings list.

Audio Processing

NOTE: The Orban Audio Processor is an optional item.

This section describes how to configure and operate the Orban Audio Processor in your transmitter. There are 27 factory Orban presets available. You can interface with audio processor functionality locally, using the front panel UI or the remote AUI. The extent of the features available depends on which interface is used.

Select an Orban audio processor preset using either the remote AUI (see [Other Settings on page 2.2.43](#)) or the front panel UI (see [Orban Inside Present on page 2.2.124](#)).

NOTE: This section contains frequent reference to Orban's Optimod-FM 5500 Digital Audio Processor Operating Manual (see the link below). The equipment covered in the 5500 manual uses the same Orban audio processor as in your transmitter. The 5500 manual provides detailed information on the audio processor's functionality. If a discrepancy exists between the operational instructions in the Orban manual and this document, the latter shall prevail as this document is specific to operation with an VX150 to VX2 transmitter. View the Orban Optimod-FM 5500 Digital Audio Processor Operating Manual online at:

https://www.orban-europe.com/downloads/5500i/Documentation/5500i_3.0_Operating_Manual.pdf

(the version number referenced in this link is controlled by a third party and is subject to change without notice).

Orban Enabling - Using the Remote AUI

In the Settings -> Audio Processing page, select the desired Orban Preset by clicking the circle to the left of the preset name. After confirming Yes in the Change Active Orban Preset window, a green checkmark will indicate that the preset is enabled. See [Figure 2.2.27 on page 2.2.50](#)).

If you edit an Orban factory preset and make a change, you have two options: Cancel or Save As. When you choose Save As a dialog prompts you for a name for the new preset - the field is empty.

NOTE: You can only edit the active (green checkmarked) Orban preset. You cannot edit a preset when it is not active.

Figure 2.2.27: Settings - Audio Processing

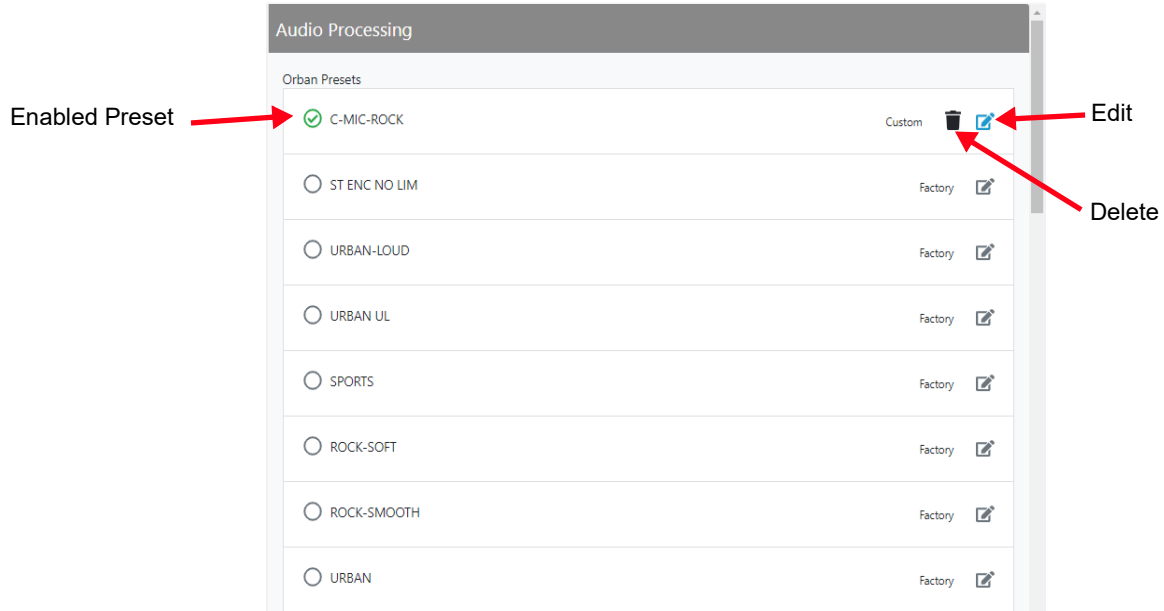

By clicking the Edit icon, you can change the various settings for the active preset. See [Figure 2.2.28 on page 2.2.51](#).

The Audio Processing selections include:

Less More, Stereo Enhancer, AGC, EQ, Final Clipping, Multiband, Compressors, Bandmix, and Multiband Distortion. Refer to the Operation section of the Orban Optimod 5500 manual for detailed information on these meters.

To activate any changes in the Audio Processor page, the following options apply:

- for Factory presets - Save As or Cancel
- for Custom presets - Save, Save As and Cancel

When creating a new preset, you must enter a new name in the Save Preset window before clicking the Save As button. Click Cancel to discard changes and return to the Audio Processor page.

NOTE: Selecting an Orban preset locally will cause the remote AUI to also reflect the change. The same occurs on the front panel UI when remotely selecting a preset. To create a new Orban Audio Processor Preset, see [Audio Processing on page 2.2.49](#).

NOTE: The Audio Processor page contains nine tabbed sections that allow managing of Orban presets. These tabbed pages (see [Figure 2.2.28 on page 2.2.51](#)) illustrate the many parameters associated with an Orban preset. Detailed descriptions are not included in this document. Refer to the Orban Optimod 5500 manual for more information on setting these parameters.

Figure 2.2.28: Audio Processing - Edit

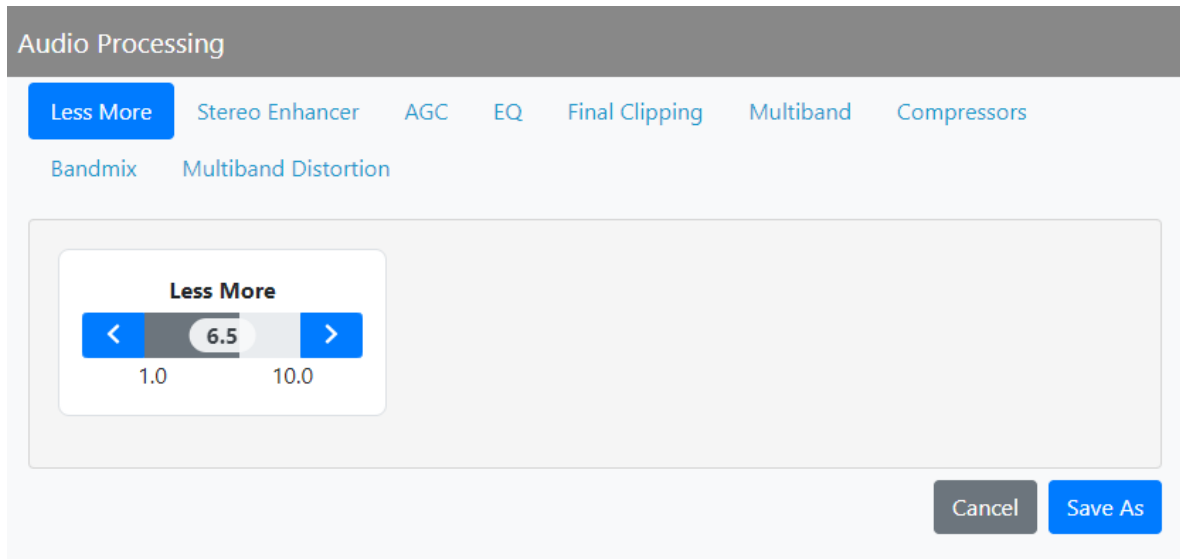

WARNING!

WHEN YOU OPEN THE AUDIO PROCESSOR PAGE WHILE THE TRANSMITTER IS ON AND ORBAN IS ENABLED, THE ACTIVE PRESET IN THE ORBAN AUDIO PROCESSOR IS LOADED BY DEFAULT. LOADING ANOTHER ORBAN PRESET CAUSES THAT PRESET TO BECOME ACTIVE, MAKE SURE YOU UNDERSTAND THE IMPACT THAT A PRESET CHANGE WILL HAVE ON YOUR BROADCAST.

Exciter VCXO

You can calibrate the internal clock reference to an external 10 MHz clock (e.g. GPS synchronized 10 MHz clock), using the remote AUI.

NOTE: During calibration, the external 10 MHz clock should be connected to the EXT 10 MHz IN (A1J4A) BNC connector on the rear of the transmitter. Disable the External 10MHz in the transmitter's settings before running a calibration. When this setting is enabled, it forces the exciter clock to continually be disciplined by the External 10 MHz signal, preventing a one-time calibration.

To view the AUI's Exciter VCXO screen (see [Figure 2.2.29](#)), select Exciter VCXO from the Settings menu.

Figure 2.2.29: Settings - Exciter VCXO Calibration

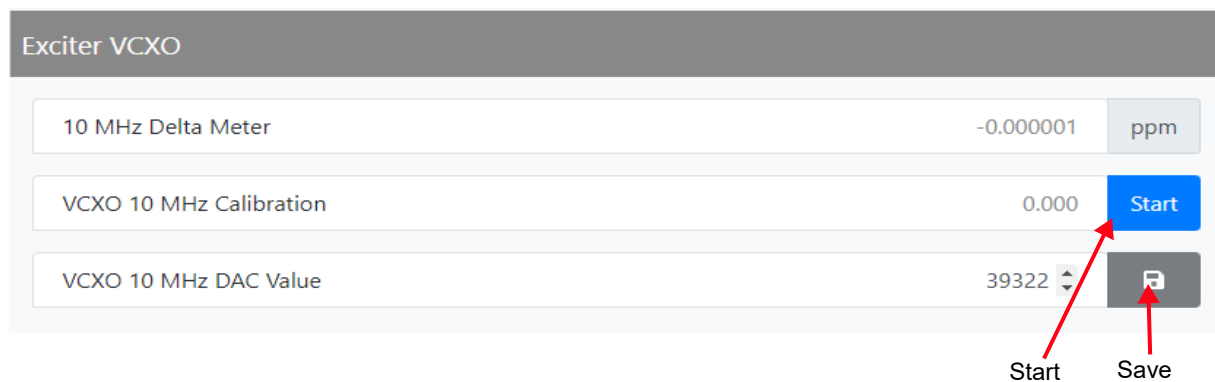

The 10 MHz Delta Meter value is for display only and is not user adjustable.

Once the external 10 MHz clock reference is connected, the user can click the Start button to automatically calibrate the internal VCXO to the external reference source.

The VCXO 10 MHz DAC Value can be adjusted for manual calibration without an external source. Click the Save icon to apply the change.

External 10 MHz

You can configure the VX150 to VX2 to accept an external 10 MHz input using the AUI or using the front panel UI (see [FM Polarity](#), on page 2.2.139).

This setting allows the user to mask the associated 10 MHz alarm from appearing in the Event History page if it isn't being used. If an external 10 MHz source is being used, an alarm will be activated on the Event History page should the external signal be lost.

NOTE: The exciter will be monitoring for the presence of an external 10 MHz signal all the time, even if the set to "disabled" and will not take any action. If the Pilot Sync option is enabled in the active preset, then the state of the external 10 MHz enable is ignored and the exciter will continuously regulate the RF carrier signal based on the external 1PPS signal.

To enable the External 10 MHz input on the AUI's External 10 MHz page (see [Figure 2.2.30](#)), slide the External 10 MHz Enable/Disable switch to the right and click Save.

Figure 2.2.30: Settings - External 10 MHz

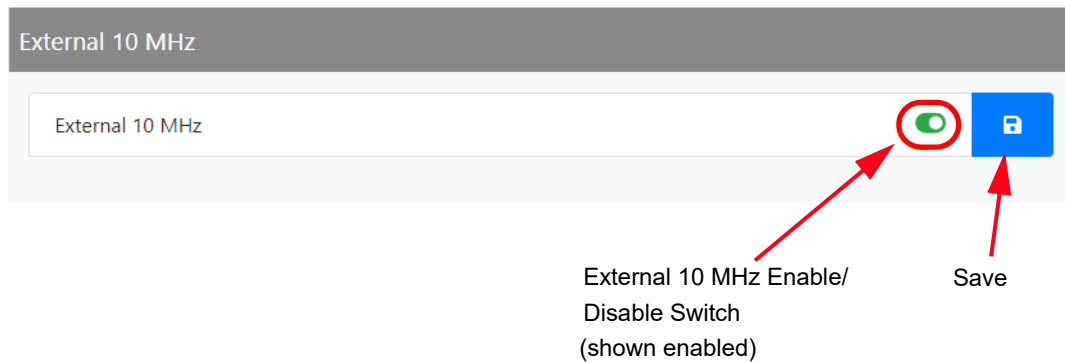

Network

CAUTION!

When connecting to a Nautel transmitter, we support both HTTP and HTTPS protocols. If using HTTP, the data traffic is not encrypted, meaning your username/password could be compromised. For security reasons, Nautel recommends using HTTPS whenever possible.

You can configure network settings using the remote AUI (see [Figure 2.2.31](#)). If you change a network setting on the front panel UI, it will also be reflected on the remote AUI, and vice versa.

NOTE: Nautel recommends that network settings be entered/vetted by a qualified Network Administrator. If parameters are changed and the AUI is reset, record the new values (or see the local front panel UI) to ensure you can log in after changes are made.

Figure 2.2.31: Settings - Network

The screenshot shows a web interface for network configuration. It has a title bar 'Network' and two main sections: 'General' and 'DNS Servers'. The 'General' section contains a table of network parameters. The 'DNS Servers' section contains a table of DNS server addresses. At the bottom right, there are 'Cancel' and 'Save' buttons.

General	
Mac Address	70:B3:D5:87:C2:FB
DHCP	<input checked="" type="checkbox"/>
IP Address*	192.168.0.99
Subnet Mask*	255.255.255.0
Gateway*	192.168.0.1
Status	Running

DNS Servers	
DNS 1*	24.222.0.94
DNS 2*	24.222.0.95

All IP addresses shown are for reference purposes only

Determining DHCP Setting

One of the main decisions in configuring the network connection on your VX150 to VX2 transmitter is whether you set DHCP to ON or OFF. If you are connecting to a network, consult with a network administrator before connecting the transmitter to your network to determine whether to enable (turn ON) or disable (turn OFF) the DHCP setting.

NOTE: DHCP can only be set from on/off from the front panel UI.

When DHCP is set to ON (default from factory), IP addresses are assigned automatically by the network server. In order for this feature to function properly, you must have a network-viewable DHCP server on your network.

If a DHCP server is not present, you (or your network administrator) must provide static addresses for IP, netmask, gateway and nameservers (gateway and nameservers are optional). You must enter them manually using the transmitter's front panel. In this case, DHCP should be set to OFF.

NOTE: A nameserver: (also called a DNS) translates a host name (e.g., mail.nautel.com) to an IP address such as in configuring email (see [Network on page 2.2.54](#) and [Email Server on page 2.2.58](#)).

Network Setup - Using the AUI

NOTE: The following settings should be entered/vetted by a qualified Network Administrator.

By entering the VX150 to VX2's established IP address into an Internet browser's address bar, and then logging into the AUI, you can view the network parameters (see [Figure 2.2.31 on page 2.2.54](#)). You can only edit parameters from the FPUI, refer to [Network - see page 2.2.100](#)).

The Status field identifies the status of the network.

- **RUNNING:** transmitter is connected to a network and is functioning properly.
- **NOT RUNNING:** transmitter is not connected or is not functioning properly. When in this state, remote AUI access is not possible.

Notifications

The Notifications feature (see [Figure 2.2.32](#)) provides a means for the transmitter to issue emails or texts (SMS messages) triggered by user defined alarm events. If you use this feature, you must also configure an email server (see [Email Server on page 2.2.58](#)).

Figure 2.2.32: Settings - Notifications

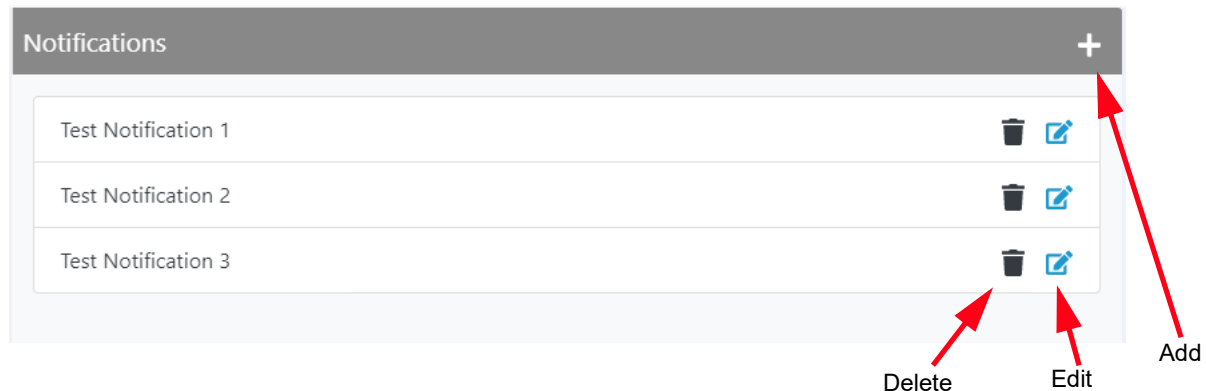

To configure the notifications feature, perform the following steps:

1. Pre-existing notifications are displayed in the Notifications list (e.g., "Audio Loss"). Click Add to create a new item for notification, click Edit (after highlighting an existing item) to edit an existing item or click Delete to erase an item.
2. When you click Add or Edit, the screen in [Figure 2.2.33 on page 2.2.57](#) will appear. This screen allows you to add or edit a Notification Name, Recipient Email(s) (use a semi-colon to separate multiple email addresses, as applicable), and define the alarm list by Device type. Add or remove alarms by moving them (using the > and < arrow buttons) from the Available Alarms list to the Selected Alarms list. An email is issued when any alarm in the Selected Alarms list is active.

Text (SMS) Messaging: In the Recipient Email field, you can enter a standard email address to initiate an email or you can enter a mobile phone number and SMS gateway to initiate a text (SMS message). The email-to-SMS text format is mobilenumbers@mobile_gateway (e.g., 5551234567@txt.bell.ca). Check with your mobile carrier to determine the proper gateway address for your area.

3. When complete click the Send Test Notification button to send a test email to the associated email address. Click Save to accept changes or the Cancel button to discard changes and return to the Notifications page.

Figure 2.2.33: Notifications/Email Server Configuration Page

Notifications

External Interlock

Email Server Configuration

General

Host*

Port* 465

Transmitter Name* VX1

Sender Email*

Authentication

Username*

Password*

Show Password

Cancel Save

Send Test Email

Recipient Enter Email

Send Test Email

Authentication enabled for reference purposes only

All IP addresses shown are for reference purposes only

Email Server

Email Server (see [Figure 2.2.33 on page 2.2.57](#)) allows you to configure email parameters (e.g., email server and port number), and is required if the notification feature is used.

NOTE: Nautel recommends that the following settings be entered/vetted by a qualified Network Administrator.

From the Notifications menu, the Email Server fields must be completed to configure the email feature. Perform the following steps (see [Figure 2.2.33 on page 2.2.57](#)):

Enter the following five parameter fields:

- **Host:** In order to enter a server name (e.g., mail.nautel.com), at least one nameserver IP address must be entered.
- **Port Number:** This logical connection end point uses a number to identify the type of process to which an internet or other network message is to be forwarded to when it arrives at a server. Typically, this is set to 25 for unencrypted SMTP systems and 843 for encrypted email.
- **Transmitter Name:** Set to a name that associates to the transmitter such as station identification (e.g., VS_WXYZ). This name will be included in notification emails.
- **Sender Email Address:** Enter as a standard email address (e.g., a@b.com). This will be the sender address that notification email recipients will see. Free web based email service accounts (Gmail, Hotmail, Yahoo mail etc.) are acceptable here.
- **Authentication:** If your email server requires authentication to send emails, click the check box and enter the appropriate Username and Password to allow this. If the check box is not selected, the Username and Password fields do not appear.

NOTE: The transmitter will automatically handle encryption if the associated mail server requires it.

When complete click Save to store these settings. Enter a recipient email address in the Send Test Email section and click the Send Test Email button to test your settings. Click the Save button to run the test or the Cancel button to return to the Notifications page.

Security Certificates

The AUI supports HTTPS connections and to take advantage of this, the user must either use a free or purchased Security Certificate.

Security uses public and private keys to ensure that the site is verified that is what it purports to be and therefore safe.

For most users there is no need to add a Security Certificate, as the connection to the transmitter is controlled by the customer's network architecture, however, it is available for organizations that wish to take extra precautions.

Security Certificates are uploaded to the transmitter via the Settings > Security Certificates menu. Purchased certificates are provided by Certificate Authorities:

https://en.wikipedia.org/wiki/Certificate_authority

Click the Browse button to search for the certificate and press Upload to activate. See [Figure 2.2.34](#).

Figure 2.2.34: Settings - Security Certificates

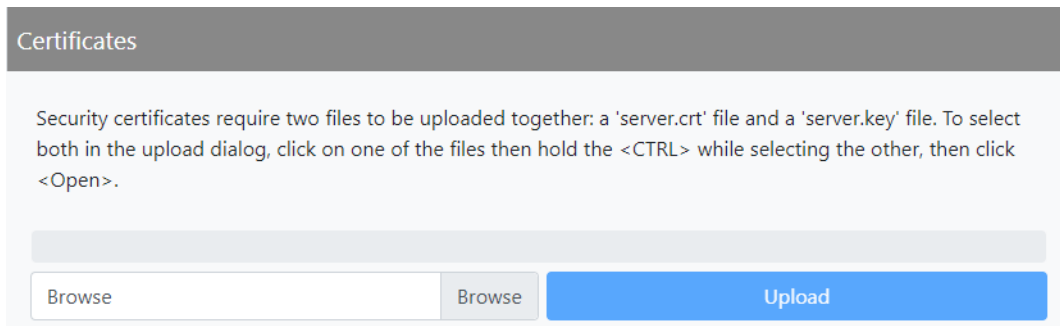

SNMP

The SNMP configuration page provides a user with a means to configure the SNMP agent and the associated traps (see [Figure 2.2.35](#)).

Figure 2.2.35: Settings - SNMP

SNMP

General

SNMP Version v2C ▾

Agent Port* 161

Read Community String

New String

New String (Confirm)

Show String

Add

✕
👁

Write Community String

New String

New String (Confirm)

Show String

Add

✕
👁

Enable Traps 🟢

Available Trap Settings

SNMP Trap Settings ▾

No SNMP Trap Settings

➔
➔
✎
🗑
+

Selected Trap Settings

SNMP Trap Settings ▾

TRAP to 127.0.0.1:162

Traps enabled for reference purposes only

Cancel
Save

Configure the SNMP agent as follows:

1. Enter the first five fields, noting the following:
 - **Agent Port:** Enter the UDP port where the SNMP agent checks for requests. The default setting is 161. If your transmitter is behind a firewall, you must open this port to use SNMP.
 - **Read Community String:** Enter the password for the SNMP client application to allow acquisition of channel values. Provide confirmation of this password by re-entering it in the Confirm field.
 - **Write Community String:** Enter the password for the SNMP client application to allow changing of channel values. Provide confirmation of this password by re-entering it in the Confirm field.
2. Select **Enable Traps** to allow the SNMP agent to send trap notifications, and to display two additional fields associated with traps. Enter the two additional fields as follows:
 - **Trap Receiver IP:** Enter the IP address of the computer to which the SNMP agent will send trap notifications. The computer must be running an SNMP application that is configured to receive traps. The SNMP agent will send trap notifications to only one recipient.
 - **Trap Receiver Port:** Enter the UDP port where the SNMP agent will send traps. The default setting is 162.
3. When complete press **Save** or press the **Cancel** to restore the previous settings.

NOTE: Check the **Read Community** and **Write Community** passwords after a software upgrade. Some upgrades will clear passwords and require them to be reset.

Spectrum Mask

The Spectrum Mask page allows users to select the appropriate FM mask standard being used by the Dashboard spectrum analyzer. See [Figure 2.2.36](#). Use the Mask Type dropdown menu to select the desired mask (factory setting is FCC). Press the Save button to enable the mask.

There are three mask options to choose from:

- ❖ FCC
- ❖ ETSI
- ❖ None

NOTE: Selecting the spectrum mask standard applies only to FM mode of operation.

Figure 2.2.36: Settings - Spectrum Mask

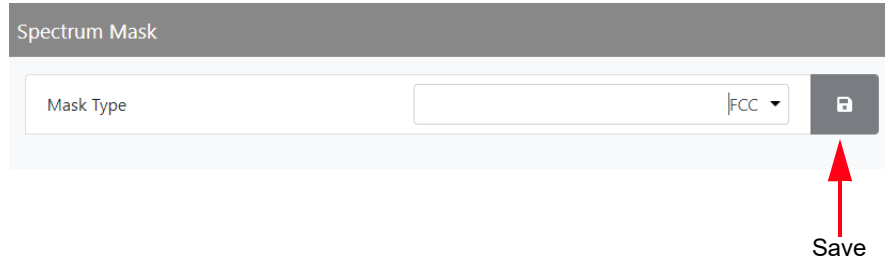

System Preferences

The System Preferences page allows the user to display the Temperature units in either Celsius or Fahrenheit. See [Figure 2.2.37](#).

Select from the dropdown menu and click the Save icon to save the changes.

Figure 2.2.37: Settings - System Preferences

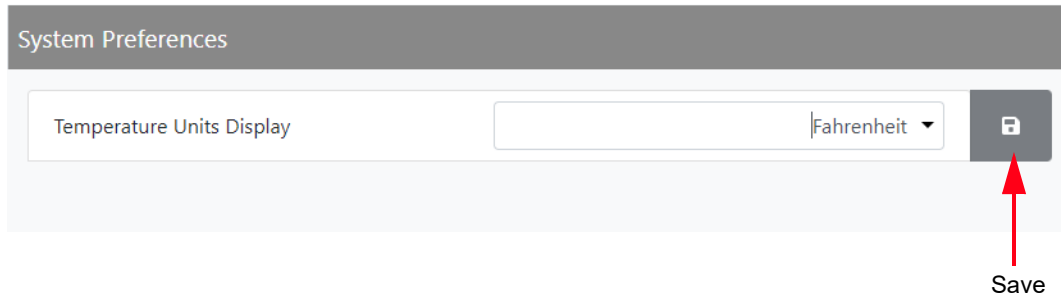

Thresholds

To set the Forward Low Thresholds, (see [Figure 2.2.38](#)), select Forward Low from the Settings menu. There are two thresholds available - Low Forward Power and Very Low Forward Power. Use the up and down arrows to change the levels of the parameter and click the Save button.

If you change a setting on the remote AUI, it will also change on the front panel UI, and vice versa.

Figure 2.2.38: Settings - Thresholds

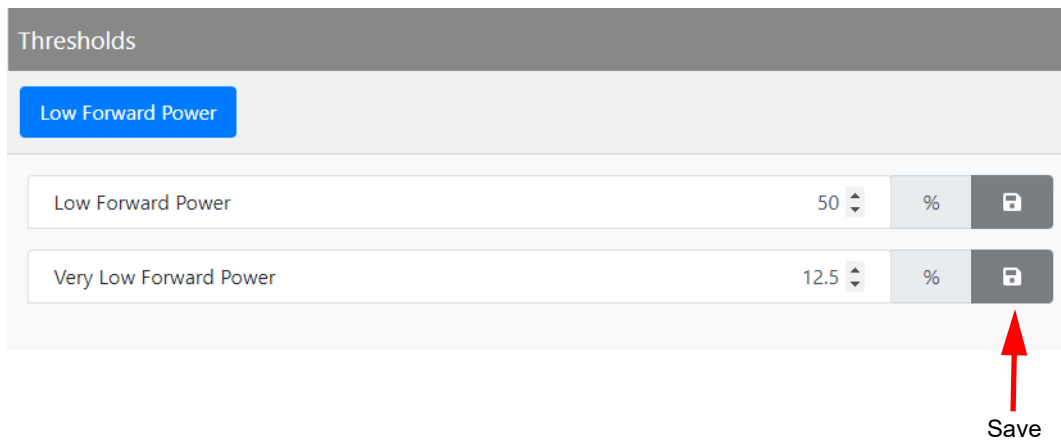

NOTE: Audio Low thresholds are managed in the Presets menu.

Time

The VX150 to VX2's internal clock uses a super capacitor and therefore maintains an accurate date and time, even during power outages. The date and time needs to be set when the transmitter is first installed or might need to be reset after a power outage lasting longer than 24 hours.

If the NTP feature is enabled (see [Figure 2.2.39](#)), the clock will set automatically and cannot be manually adjusted.

You can also set the time and date using the Front Panel UI (see [NTP Sync on page 2.2.121](#) and [Set Date on page 2.2.122](#)). If you change the clock setting on the front panel UI, it will also be reflected on the remote AUI, and vice versa.

Setting the Clock - Using the AUI

You can remotely set the VX150 to VX2's time and date by selecting Time from the Settings menu. See [Figure 2.2.39](#)).

Figure 2.2.39: Settings - Time

The screenshot shows the 'Time' settings page. It has a header 'Time' and two main sections. The 'NTP' section includes a toggle switch labeled 'NTP Enable/Disable Switch (shown enabled)' which is turned on and circled in red. Below it is a text field for 'NTP Server*' with the value 'ntp.ubuntu.com'. The 'Time Settings' section includes a toggle switch for 'UTC' which is turned on, and a text field for 'Current Timezone' with the value 'Universal'. At the bottom right, there are 'Cancel' and 'Save' buttons.

The Time option allows users to set the exact time and date information as well as regional and timezone settings for a transmitter location.

Procedure to set up the time and date:

1. Select the Time option from the Settings page.
2. Enter the following location parameter:
 - Timezone - select the appropriate timezone based on Country selection.

3. Enter Time and Date parameters and press Save. Press Cancel to discard changes. Please note that Time and Date cannot be set via this menu if NTP is enabled (see [Figure 2.2.39 on page 2.2.64](#)).
 - Date - select values from the calendar icon for Day, Month, and Year.
 - Time - select values from the clock icon for hours (24-hour clock) and minutes (up to 60). You can click Now to set the clock to the current time.

NOTE: Changes cannot be made via this menu if NTP is enabled. Disable NTP, make required changes in the Time menu then re-enable NTP.

NOTE: Ensure the proper Timezone is selected to observe Daylight Savings time (DST).

NTP servers

You can configure an NTP (Network Time Protocol) server to allow clock synchronization with all computers on the same network as the transmitter.

NOTE: The accuracy of the NTP synchronization is related to the distance to the server, therefore Nautek recommends you choose servers in the same country as the equipment. If this is not possible, attempt to connect to servers from the same continent.

NOTE: The NTP clock synchronization polling interval varies between 64 and 1024 seconds. To minimize network traffic, the interval will change depending on how much error is accumulated between polling events and will be increased if the remote NTP server becomes unreachable. The polling interval is also randomized slightly to avoid the situation where a large number of requests are always arriving at the NTP server at the same time.

Enabling NTP

Enable the NTP function by moving the NTP toggle switch to the right (displays green). Disable by moving the NTP toggle switch to the left. When NTP is disabled, the Current Timezone fields (Country and Zone, as applicable) are also displayed (see [Setting the Clock - Using the AUI on page 2.2.64](#)). Click the Save button to activate any change.

Transmitter Info

NOTE: Nautel recommends adding a Transmitter Name and Serial Number to the Transmitter Info section. This will provide easy transmitter identification when using the remote AUI. The serial number is found on the rear of the transmitter (e.g., 100xxxxx or 200xxxxx).

The Transmitter Info page allows the user to name the transmitter as a simple identifier. See [Figure 2.2.40](#). Enter the information to be used as follows (Transmitter Name, Serial Number).

The Serial Number for your transmitter can be found on the transmitter's rear panel on a white label below the bar code and on the outside of the packing box on a similar white label. Saving the Serial Number to this field makes it easy to reference when communicating with Nautel Customer Service.

Click the Transmitter Name or Serial Number bar to enter a new name or serial number or edit a previous one and press the Save button to save the changes.

Figure 2.2.40: Settings - Transmitter Info

The screenshot shows a 'Transmitter Info' settings page with the following fields and values:

Field	Value
Transmitter Model	VX2
MAC Address	8C:1F:64:A3:20:19
Hardware Unique ID	365931353036110C001600
Transmitter Unique ID (GUID)	7f0db82b340f4f618d236ff810356f6b
Transmitter Name/Call Sign	
Serial Number	

Red arrows point to the lock icons on the right side of the 'Transmitter Name/Call Sign' and 'Serial Number' fields. The word 'Save' is written below the arrows.

Users

NOTE: This function is only available via remote connection to the AUI.

The Users menu (see [Figure 2.2.41](#)) allows a user with the proper permissions to create accounts to allow certain users to access and control features of the AUI, and receive notifications when critical-level or maintenance-level alarms occur. To view this menu, select Users from the Settings menu.

NOTE: Depending on the permission level assigned to a given user, some features shown in [Figure 2.2.42](#) on [page 2.2.69](#) may not be displayed or available.

Each VX150 to VX2 transmitter has two pre-defined user accounts when it leaves the factory: "Admin" and "Viewer". The Admin account has full permissions for configuring the transmitter via the AUI. The password for the Admin account is "change_me" and the password for the Viewer account is blank. Nautel recommends that you change the password for the Admin account immediately and store the new password in a safe place. This will prevent others from changing your password from the default and locking you out of your transmitter. See [Logging into the AUI on page 2.2.10](#).

Figure 2.2.41: Settings - Users

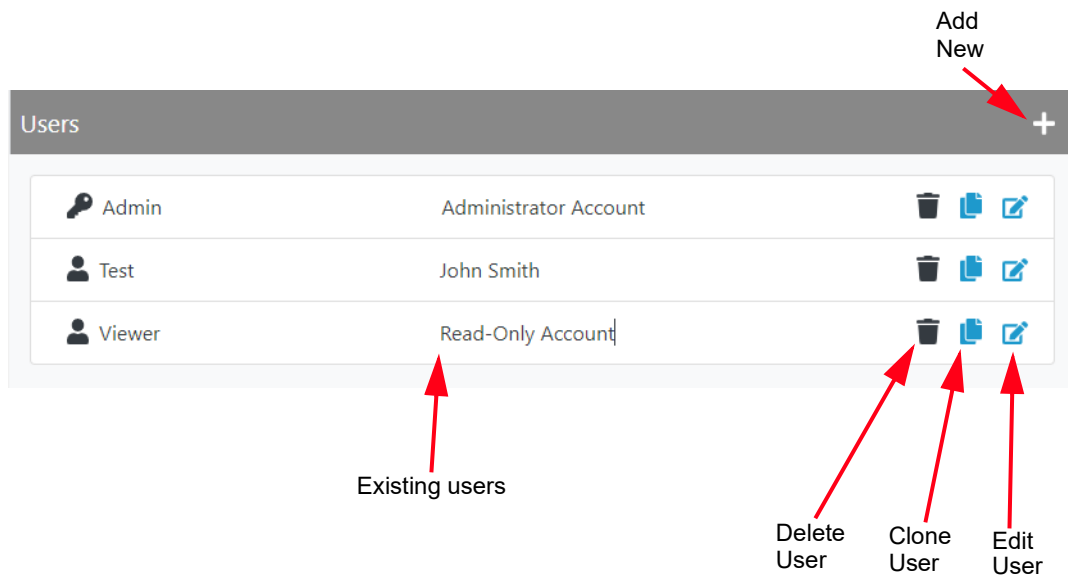

NOTE: There is no way for Nautel to reset your AUI passwords.

Setting Permissions

There are three user permissions, each with their own specific functionality. See [Figure 2.2.42 on page 2.2.69](#). All users have permission to change their own name, email, language and password, after their account has been created, but are otherwise limited to the following functions:

- Administrator: Pre-defined user type. Can perform all functions. Administrator is the only permission level that allows addition, deletion or editing of users.
- RF Control: Pre-defined user type. Allows the user to turn the RF output on and off. No administrative functions.
- Edit Presets: Pre-defined user type. Allows the user to modify presets and change active preset. No administrative functions.

Click Save to activate the changes.

Adding/Editing Account Information

If the Permission user role is Administrator, you have permissions to edit any user account. Other roles are limited.

Add an Account

To add a user account, click the + symbol in [Figure 2.2.41 on page 2.2.67](#). Enter the User Form (see [Figure 2.2.42 on page 2.2.69](#)) with user account information, including First Name, Last Name, Email, Language and Permissions. Click Save to accept. See also [Set or Change the Password on page 2.2.69](#).

Edit an Account

To edit an existing user account, click the Edit User icon of the desired user in the Users list (see [Figure 2.2.42 on page 2.2.69](#)). The User Form for that user will be displayed. You can edit the Name, Email, Language, Permissions and Password (see [Set or Change the Password on page 2.2.69](#)). Click Save to accept.

Figure 2.2.42: User Form Page

User

Information

User Name	Admin
First Name	Administrator
Last Name	Account
Email	
Language	English ▼

Permissions

Edit Presets	<input type="checkbox"/>
RF Control	<input type="checkbox"/>
Administrator	<input checked="" type="checkbox"/>

Change Password
Cancel
Save

Set or Change the Password

To set or change your password, click Change Password at the bottom, left of the User Form screen. A menu appears (see [Figure 2.2.43 on page 2.2.70](#)) that prompts you to enter the old password (as applicable), new password and confirmation of the new password. Click the OK button to accept changes or the Cancel button to discard changes and exit this menu.

NOTE: If the user is defined as an Administrator and the account password is changed, store the new password in safe/secure location, as Nautel cannot reset the password.

Figure 2.2.43: Changing Password

The screenshot shows a 'Change Password' dialog box. It features a dark blue header with the title 'Change Password' and a close button (X). Below the header are three text input fields: 'Old Password', 'New Password', and 'New Password (Confirm)'. Each field has a toggle icon on the right side. At the bottom of the dialog are two buttons: 'Cancel' and 'Save'.

Delete an Account

To delete a user account, click the Delete User icon of the desired user in the Users list (see [Figure 2.2.41 on page 2.2.67](#)). Click Continue in the confirmation window to delete the user account or click Close to keep the user account and return to the Users list.

NOTE: An account with Administrator permissions can delete any account, except the account they are actively logged into. If only one user account (it can only be an Administrator account) remains it cannot be deleted.

Do not attempt to delete the account you are currently logged into.

Remote I/O

The Remote I/O page allows the user to configure the remote input/output interface for the transmitter. Refer also to the VX150 to VX2 Installation Manual for information on remote inputs and outputs and their factory default settings.

- Digital Inputs (see [Digital Inputs](#))
- Digital Outputs (see [Digital Outputs on page 2.2.74](#))
- Analog Outputs (see [Analog Outputs on page 2.2.76](#))

Digital Inputs

Using the Digital Inputs page (see [Figure 2.2.44](#)), you can configure up to seven inputs that allow you to remotely control various operational characteristics of the transmitter. Unless otherwise noted, these inputs are only accepted by the transmitter if remote control has been enabled. That setting can only be made by a local user using the front panel UI's REMOTE button (its LED is green when remote is enabled). Nautel sets remote input defaults prior to shipping. See the Installation Manual for details.

Figure 2.2.44: Remote I/O - Digital Inputs Page

Digital Inputs						
#	Name	Channel	Control	Level	Edit	
1	Input 1	RF On/Off	Rising Edge, Activate	1		
2	Input 2	RF On/Off	Rising Edge, Deactivate	1		
3	Input 3	Preset 1 Active	Rising Edge, Set	1		
4	Input 4	Unassigned	Unassigned	1		
5	Input 5	RF Power Adjust	Rising Edge, Increase	1		
6	Input 6	RF Power Adjust	Rising Edge, Decrease	1		
7	Input 7	Alarm Reset	Rising Edge, Reset	1		

The current settings for Input 1 through Input 7 are displayed, including the Channel and Control settings, as well as the current logic Level (1 or 0). You can edit Channel and Control settings by clicking the edit icon for the desired input. This displays the menu in [Figure 2.2.45 on page 2.2.72](#).

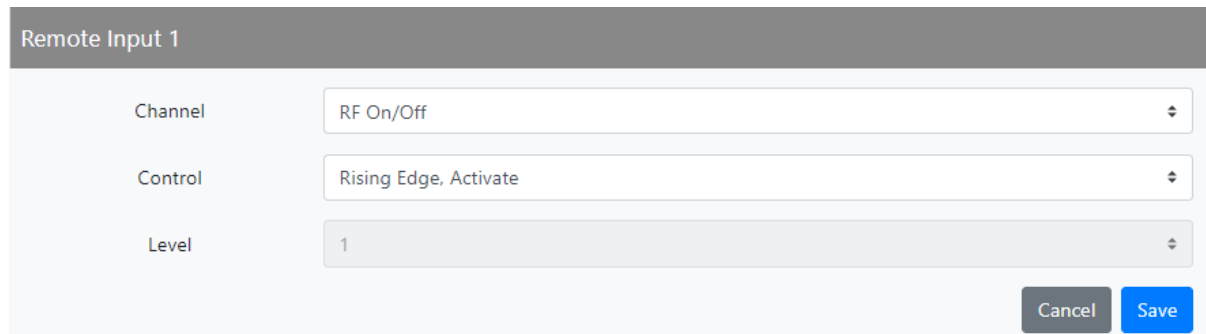
Figure 2.2.45: Input Editing Menu

Remote Input 1

Channel	RF On/Off
Control	Rising Edge, Activate
Level	1

Cancel Save

Select Input Channel

From the editing screen for remote input 1 through 7, you can configure the input for one of a variety of channel inputs. Click the Channel field's up/down arrows to display the following options:

- ❖ Unassigned. No effect on transmitter operation, regardless of logic level.
- ❖ RF On/Off. Same as pressing the RF On (telling the system to provide RF power, if possible) or the RF Off button on the FPUI. There are two inputs configured by default; one for Falling Edge, Activate and one for Falling Edge, Deactivate.
- ❖ Preset 1 Active: Selects preset 1 as active.
- ❖ Preset 2 Active: Selects preset 2 as active.
- ❖ RF Power Adjust. Activating these inputs will increment/decrement the current preset power level by 1% of the rated power. Holding the selection will increment/decrement the power level by 1% every 1/2 second. There are two inputs configured by default; one for Falling Edge, Increase and one for Falling Edge, Decrease. **NOTE:** If multiple power increase or decrease inputs are active, the lower number input takes precedence.
- ❖ Alarm Reset. Initiates a reset for latched alarms. Same as initiating an Alarms Reset from the FPUI's main menu.

Click Save to activate changes. Click Cancel to cancel changes and return to the Remote Inputs screen. If you save a change to a remote input via the AUI, it will also be displayed on the FPUI.

Configure Input Control Logic

From the editing screen for remote input 1 through 7, you can configure the input's active/inactive control logic. Click the Control field's up/down arrows to display the following options, noting the options differs for each Channel input:







Channel	Control options	Description
Unassigned	Unassigned	No logic setting.
RF On/Off	Rising Edge, Activate Falling Edge, Activate Rising Edge, Deactivate Falling Edge, Deactivate Rising Edge, Toggle Falling Edge, Toggle Active High, Turn On. Active Low, Turn Off. Active High, Turn Off. Active Low, Turn On.	Logic '1' (high or rising edge) activates the input. Logic '0' (low or trailing edge) activates the input. Logic '1' (high or rising edge) de-activates the input. Logic '0' (low or trailing edge) de-activates the input. Logic '1' (high or rising edge) activates the input; next logic '1' (high or rising edge) de-activates the input. Logic '0' (low or trailing edge) de-activates the input; next logic '0' (low or trailing edge) activates the input. Logic '1' (high) causes an RF on. Logic '0' (low) causes an RF off. Logic '1' (high) causes an RF off. Logic '0' (low) causes an RF on.
Preset 1/2 Active	Rising Edge, Set Falling Edge, Set Active High, Activate Active Low, Activate	Logic '1' (high or rising edge) selects the preset. Logic '0' (low or trailing edge) selects the preset. Logic '1' (high) activates the preset. Logic '0' (low) activates the preset.
RF Power Adjust	Rising Edge, Increase Falling Edge, Increase Rising Edge, Decrease Falling Edge, Decrease Active High, Increase Active Low, Increase Active High, Decrease Active Low, Decrease	Logic '1' (high or rising edge) causes a power increase. Logic '0' (low or trailing edge) causes a power increase. Logic '1' (high or rising edge) causes a power decrease. Logic '0' (low or trailing edge) causes a power decrease. Logic '1' (high) causes a power increase. Logic '0' (low) causes a power increase. Logic '1' (high) causes a power decrease. Logic '0' (low) causes a power decrease.
Alarm Reset	Rising Edge, Reset Falling Edge, Reset	Logic '1' (high or rising edge) causes a reset. Logic '0' (low or trailing edge) causes a reset.

Click Save to activate changes. Click Cancel to cancel changes and return to the Remote Inputs screen.

Digital Outputs

Using the Digital Outputs page (see [Figure 2.2.46](#)), you can configure up to six outputs that indicate either the presence of various alarms or the status of operator controlled circuits. Nautel sets remote output defaults prior to shipping. See the Installation Manual for details.

Figure 2.2.46: Remote I/O - Digital Outputs Page

Digital Outputs					
#	Name	Channel	Control	Level	Edit
1	Output 1	RF On/Off	Active Low	1	
2	Output 2	RF Output Fault	Active Low	1	
3	Output 3	Preset 1 Active	Active Low	0	
4	Output 4	Unassigned	Unassigned	1	
5	Output 5	Remote Status	Active Low	0	
6	Output 6	Overall Summary Alarm	Active Low	1	

The current settings for Output 1 through Output 6 are displayed, including the Channel and Control settings, as well as the current logic Level (1 or 0). You can edit Channel and Control settings by clicking the edit icon for the desired output. This displays the menu in [Figure 2.2.47](#).

Figure 2.2.47: Output Editing Menu

Remote Output 1

Channel:

Control:

Level:

Select Output Channel

From the editing screen for remote output 1 through 6, you can configure the output for one of a variety of channel outputs. Click the Channel field's up/down arrows to display the following options:

- ❖ Unassigned. No alarm or status parameter is monitored.
- ❖ RF On/Off. The active logic level indicates the transmitter's RF power stage is on (enabled). The inactive logic level indicates the transmitter's RF power stage is off.
- ❖ RF Output Fault. The active logic level indicates that an alarm is occurring that affects the RF output (power inhibition or power reduction).
- ❖ Preset 1 Active. Preset 1's output will be indicated by a logic low. The remaining, non-active preset outputs will be open collector.
- ❖ Preset 2 Active. Preset 2's output will be indicated by a logic low. The remaining, non-active preset outputs will be open collector.
- ❖ Remote Status. An active logic low level indicates remote control is enabled (i.e., local plus remote). The inactive logic level indicates remote control is disabled.
- ❖ Overall Summary Alarm. The active logic level indicates that an alarm is occurring. Any transmitter alarm can be selected as a remote output. Refer to the Troubleshooting Manual for a description of each alarm.

Click Save to activate changes. Click Cancel to cancel changes and return to the Remote Outputs screen. If you save a change to a remote output via the AUI, it will also be displayed on the FPUI.

Configure Output Logic

You can configure the active/inactive logic for each of the six remote outputs. Click the Control field's up/down arrows to display and select one of the following:

- ❖ Active Low. Logic '0' (low) indicates the output is true (e.g., RF is on); Logic '1' (high) indicates the output is false (e.g., RF is off).
- ❖ Active High. Logic '1' (high) indicates the output is true (e.g., RF is on); Logic '0' (low) indicates the output is false (e.g., RF is off).

Click Save to activate changes. Click Cancel to cancel changes and return to the Remote Outputs screen.

Analog Outputs

There are two analog outputs - forward power and reflected power - that can be remotely monitored. These outputs are factory defined parameters and cannot be changed to other parameters, however their scaling can be configured, using the Analog Outputs page (see [Figure 2.2.48](#)), to reflect the output voltage that yields a full-scale deflection.

Figure 2.2.48: Remote I/O - Analog Outputs Page

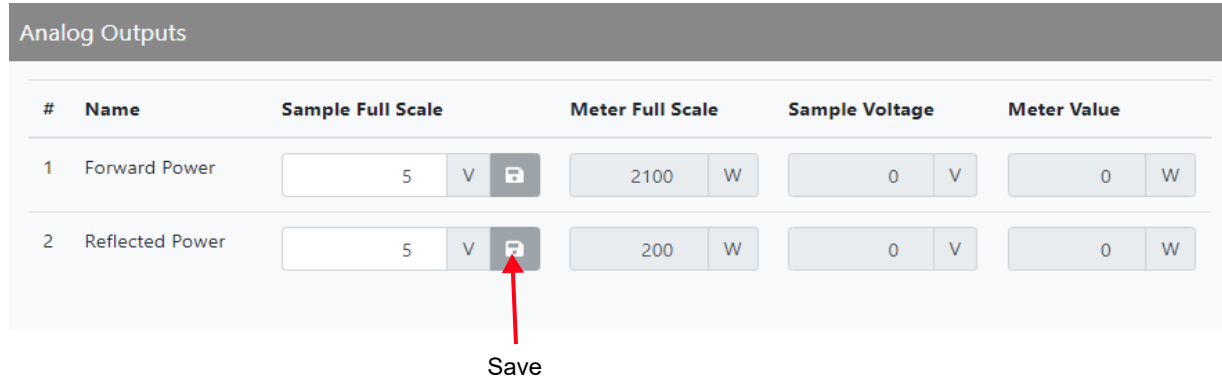

The values associated with each of these fixed meters are of a linear nature so that changes made to the Sample Full Scale field (allowable range is 1- 10 V, defaulted to 5 V) will be reflected in the other fields according to the following equation:

$$(\text{Meter Value}/\text{Meter Full Scale}) \times \text{Sample Full Scale} = \text{Sample Voltage}$$

NOTE: The Sample Voltage reading reflects the value that can be measured at the associated remote analog output pin for the given Meter Value. See the Installation Manual for actual remote analog output pin assignments.

Set the Sample Full Scale field, as desired, and Click the associated save button to activate the change.

Reports

The Reports page allows the user to view and download transmitter events by the following criteria:

- Event History (see [Event History](#))
- Active Preset (see [Active Preset on page 2.2.78](#))
- Meters (see [Meters on page 2.2.80](#))
- Settings (see [Settings on page 2.2.81](#))

Event History

In the Event History report (see [Figure 2.2.49](#)), the user can select the following criteria from the drop-down menu:

- ❖ Preset Change
- ❖ Power Change
- ❖ Freq Change
- ❖ Local Remote Change
- ❖ Alarm
- ❖ RF State Change

Click the Download Report button to save an Excel Spreadsheet copy of the Event History to the computer/laptop connected.

Click the Delete All Events button to delete the list of events.

NOTE: Deleting the event logs in the AUI does not clear the logs displayed in the FPUI.

Figure 2.2.49: Reports - Event History

Event History

Filter by Event Type

«
<
1
2
>
»

Delete All Events
Download Report

Value	Device	Name	Alarm Severity	Time	Type
Off	Controller	Need To Run Auto Bias	Critical	12/12/2022, 2:41:03 PM	Alarm
Off	Controller	Auto Bias Running	Critical	12/12/2022, 2:41:03 PM	Alarm
Off	Controller	Host Network Down	Critical	12/12/2022, 2:40:31 PM	Alarm
On	Controller	Auto Bias Running	Critical	12/12/2022, 2:40:21 PM	Alarm
Off	Controller	Missing Presets	Critical	12/12/2022, 2:40:11 PM	Alarm
Off	Controller	Host Not Booted	Critical	12/12/2022, 2:39:43 PM	Alarm

List shown for reference only

Active Preset

In the Active Preset report (see [Figure 2.2.50](#)), the user can select the following criteria from the drop-down menu:

- ❖ No Filter
- ❖ General
- ❖ Audio
- ❖ SCA
- ❖ RDS
- ❖ Other Settings

Figure 2.2.50: Reports - Active Preset

Active Preset

Filter By Preset Section

No Filter ⌵

« < 1 2 3 4 ... > »

Download Report

Section	Name	Value	Units
Other Settings	Two Slope Threshold	160	%
Other Settings	Two Slope Limiter	62464	
RDS	Traffic Info	0	
RDS	Stereo	0	
RDS	Scrolling Type	0	
RDS	Scrolling PS Name	C-MIC	
RDS	Scrolling Enable/Speed	0	

Meters

In the Meters report (see [Figure 2.2.51](#)), the user can select the following criteria from the drop-down menu:

- ❖ No Filter
- ❖ Summary
- ❖ Transmitter
- ❖ Controller
- ❖ Exciter
- ❖ HD Exciter

Figure 2.2.51: Reports - Meters

The screenshot shows a web interface for the 'Meters' report. At the top, there is a header 'Meters' and a section 'Filter By Meter Collection' with a dropdown menu currently set to 'No Filter'. Below the filter is a pagination control showing '1' and '2' with navigation arrows, and a blue 'Download Report' button. The main content is a table with the following data:

Meter Collection	Meter Name	Value	Units
Exciter	AGC Limiter Gain	100.000008	%
Exciter	Analog Left Peak	-75.9881439	dBu
Exciter	Analog Right Peak	-76.4532	dBu
Exciter	DAC Gain	0	%
Exciter	Digital 1 Left Peak	-90	dBFS
Exciter	Digital 1 Right Peak	-90	dBFS
Exciter	Forward Attenuation	31.5000019	dB

Settings

In the Settings report (see [Figure 2.2.52](#)), the user can select the following criteria from the drop-down menu:

- ❖ No Filter
- ❖ General
- ❖ Software Versions
- ❖ Exciter Thresholds
- ❖ Active Preset

Figure 2.2.52: Reports - Settings

The screenshot shows a web interface for the 'Settings' report. At the top, there is a header 'Settings' and a filter section titled 'Filter By Setting Type' with a dropdown menu currently set to 'No Filter'. Below the filter is a pagination control showing page 1 of 2, and a blue 'Download Report' button. The main content is a table with columns for Type, Name, Value, and Units. The table lists several software version settings.

Type	Name	Value	Units
Software Versions	systemplugin	0.49.5-AUTOINC+06febbb4a4	
Software Versions	RdsPlugin	0.3.1-AUTOINC+890b2e5bcb	
Software Versions	SnmpPlugin	2.6.1-AUTOINC+b7c6f0bf79	
Software Versions	controller/1	1.4.0.2	
Software Versions	fileplugin	1.12.1-AUTOINC+652f6d8216	
Software Versions	os	Beta 3.0.0	
Software Versions	oap/1	1.0.0.37	

Software

The Software menu contains the following sub-menus:

- Versions (see [Versions](#))
- Upgrade (see [Upgrades - see page 2.2.84](#))

Versions

The Versions page (see [Figure 2.2.53 on page 2.2.83](#)) in the Software menu displays the Operating version and all its associated plug-ins.

Plug-ins are referenced by Name and Version.

By clicking the Software Licenses hyperlink, the user is directed to Nautel's support website which provides a list of open source Nautel Software Licenses used by this product.

Figure 2.2.53: Software - Versions

The screenshot displays a web interface titled 'Versions'. At the top, there is a search bar containing 'OS' and a version indicator 'Beta 1.1.0'. Below this is a 'Software' section with a 'Software Licenses' hyperlink. The main part of the interface is a table listing various software components.

Name	Version
oap/1	1.0.0.37
RemoteloPlugin	0.4.0-AUTOINC+286a401b9c
Mabelabi	13.1.0-AUTOINC+4ea76a69cd
controller/1	0.0.3.165
RdsPlugin	1.0.0-AUTOINC+33734c8a48
StreamingPlugin	0.14.0-AUTOINC+ef4feca3b0
sib/1	0.0.0.92
PresetPlugin	1.8.0-r0
FirmwareSettingPlugin	0.5.1-AUTOINC+89dc7cdaec
Iris	2.48.0-AUTOINC+de62727e62
userplugin	1.19.0-AUTOINC+cc79c8a30a
HardwareInterfacePlugin	2.2.3-AUTOINC+8bbbd8511e
SchedulerPlugin	0.19.0-AUTOINC+885d16701e
systemplugin	0.59.0-AUTOINC+e48f9a8e02
notificationplugin	0.20.0-AUTOINC+b19c519d3d
EventLogPlugin	0.13.0-AUTOINC+b7deed19c1
fileplugin	1.14.2-AUTOINC+27fc5b3a78
NetworkPlugin	0.14.6-AUTOINC+3ea6879e95
TimePlugin	0.22.0-AUTOINC+885a5902a5
SnmpPlugin	2.12.0-AUTOINC+e135e3d7cf
OrbanPlugin	0.14.0-AUTOINC+722c1b5009
Mabel	0.29.3-AUTOINC+4fdf1f09ed
Maui	2.54.0

Upgrades

The Upgrades page (see [Figure 2.2.54](#)) in the Software menu allows for uploading a suite of software upgrade files (.tgz files) via remote connection. Navigate the page as described below.

For detailed information on performing a software upgrade, refer to [Software Upgrade via Remote AUI on page 2.4.5](#).

Figure 2.2.54: Software - Upgrades

The screenshot shows the 'Upgrades' page interface. At the top, there is a header 'Upgrades'. Below it, a 'Current Version' field displays '6.0.0'. Underneath, the 'Add Upgrade' section contains a 'From' field with the text 'vx-upgrade-6.0.0.tgz' and a 'Browse' button. Below that is a 'To' field with the text 'Onboard Filesystem' and an 'Upload' button. A section titled 'Select upgrade for installation' contains a large empty list area. At the bottom of the page, there are three buttons: 'Refresh List' (blue), 'Start Upgrade' (green), and 'Delete Upgrade File' (red).

The Upgrades page consists of the following sections and buttons:

- ❖ Current Version: displays the current version of software.
- ❖ Browse: allows for browsing and selection of the software upgrade file.
- ❖ Select upgrade for installation: displays the available upgrade files uploaded to the transmitter.
- ❖ Upload: uploads the selected file in the From field to the Select upgrade for installation area.
- ❖ Refresh List: refreshes all the available software files in the display area.
- ❖ Start Upgrade: initiates the upgrade to the software file selected.
- ❖ Delete Upgrade File: deletes the selected software file from the Select upgrade for installation area.

Sign Out

The Sign Out dialog (see [Figure 2.2.55](#)) allows the user to sign out of the AUI session.

Click OK to sign out or Cancel to return to the active session.

Figure 2.2.55: Sign out

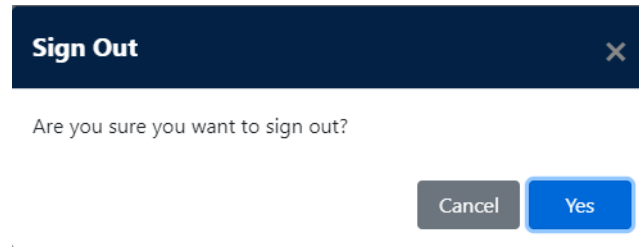

Front Panel User Interface (FPUI)

The VX150 to VX2 uses a Front Panel User Interface (FPUI) to control the transmitter locally. See [Figure 2.2.56](#) for the Dashboard display that is used for viewing purposes only. The FPUI contains a menu-based series of pages that serve specific functions.

The Dashboard screen displays the following information:

- Top block: active preset (P#), the transmitter's frequency and forward power and current time.
- Middle block: preset, output power and the desired power set point.
- Lower block: reflected power, temperature and percentage modulation.

NOTE: If a transmitter name has been assigned, the first eight (8) characters will appear in the top block between the active preset and the frequency fields.

NOTE: The Temperature measurement is the same value on the AUI's top banner and is a representation of the transmitter's current Inlet temperature. See [Advanced User Interface \(AUI\) on page 2.2.7](#).

Figure 2.2.56: FPUI Dashboard

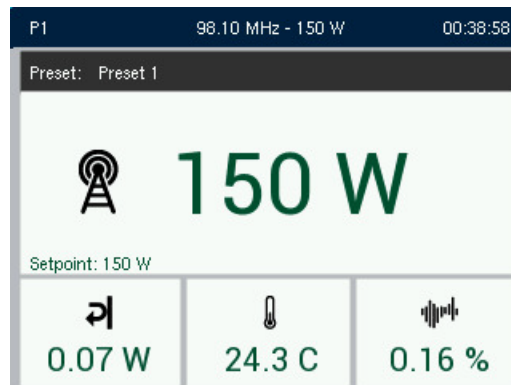

Turning RF on and off

From the front panel of the transmitter, press the RF ON/OFF button (see [Figure 2.2.57 on page 2.2.87](#)) to enable the RF. The RF ON/OFF button's LED will be red and display 'OFF' in an RF off state and will be green and display 'ON' when RF is on.

Turning Remote Control on and off

From the front panel of the transmitter, press the REMOTE button (see [Figure 2.2.57](#)) to enable remote control. The REMOTE ON/OFF button's LED will be red and display 'OFF' for remote control disabled, and will be green and display 'ON' for remote control enabled. Local control remains active in either switch state.

Saving settings

Many of the FPUI screens allow for modifying a selected setting. Press the front panel rotary knob to save a change. Press and hold the BACK button to cancel a change and revert back to the previously stored value. Pressing the BACK button for two seconds will cause the FPUI to return to the Dashboard screen.

FAULT LED

The FAULT LED (see [Figure 2.2.57](#)) on the transmitter’s front panel will be red if any fault is present. See [Alarms, on page 2.2.25](#) (remote AUI) or [Alarms, on page 2.2.91](#) (FPUI) to determine the specific fault(s).

Figure 2.2.57: Front Panel

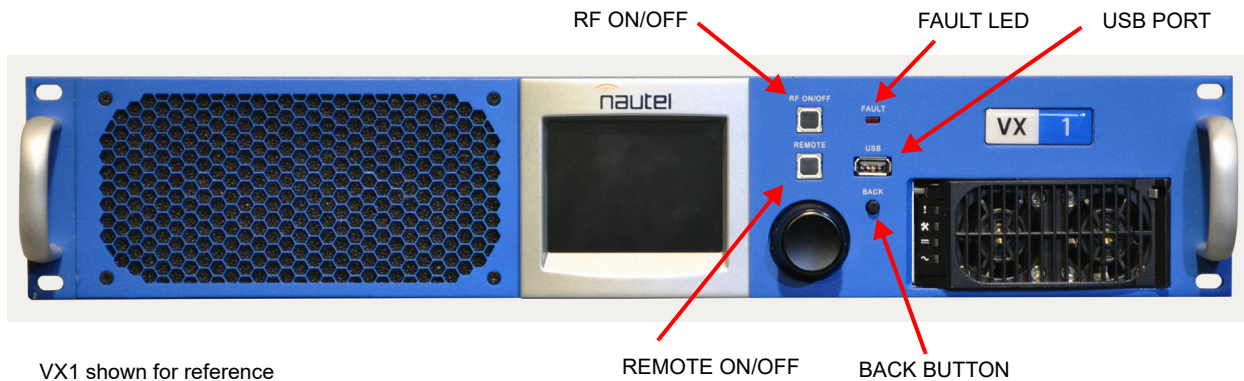

VX1 shown for reference

Front Panel UI Menu

The Main Menu is shown in [Figure 2.2.58 on page 2.2.87](#) and is navigated using the rotary knob on the front panel. Pressing the rotary knob selects the highlighted menu.

Figure 2.2.58: FPUI Main Menu

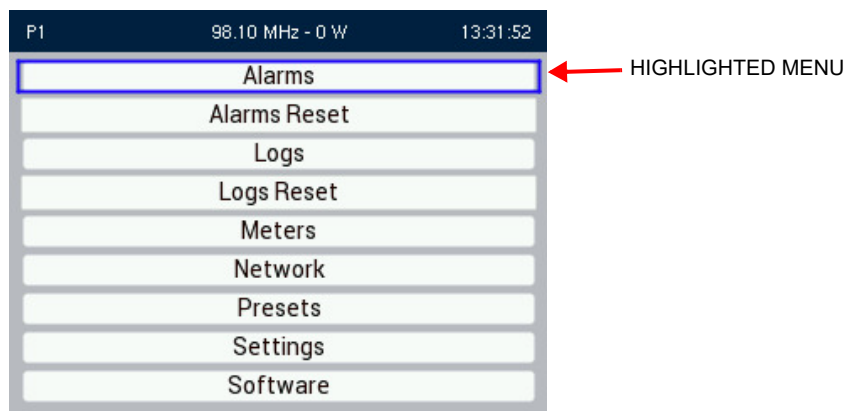

[Table 2.2.5 on page 2.2.88](#) defines the available front panel display screens. Rotate the Front Panel rotary knob to select the desired function and press the knob to enable editing.

Table 2.2.5: FPUI Screens

FPUI Screen	Function	See page
First Time Setup Screens	Guides the user through initial setup of the transmitter. Provides prompts to set frequency, output power and audio input. Refer to the VX Series Quick Start Guide, provided in the transmitter's packing box, for details.	VX Series Quick-Start Guide
Main Menu	Choose options and navigate to other screens.	page 2.2.87
Alarms	View all active transmitter alarms.	page 2.2.91
Alarm Reset	Initiate an attempt to reset all alarms controlled by latched protection circuits.	
Logs	View the transmitter's events log, including alarms, commands, etc.	page 2.2.92
Logs Reset	Clear the transmitter's events log.	page 2.2.93
Meters	View the levels of various transmitter parameters, including forward power, reflected power, PA voltage, PA current and low level dc supply voltages.	page 2.2.94
Meters - Critical Meters	View the transmitter's critical meters (Forward/Reflected power, VSWR, Peak Modulation and DC-RF Efficiency).	page 2.2.95
Meters - PA Meters	View the transmitter's PA related meters (PA volts, current, dissipation and bias).	page 2.2.95
Meters - RF Drive Meters	View the transmitter's IPA related meters (IPA Forward Power, Volts, Current, Bias and RF DAC Gain).	page 2.2.95
Meters - Cooling System Meters	View the transmitter's cooling related meters (System Interface Inlet, PA Heatsink, RF DAC and DSP temperatures, Exciter and PA fan speeds).	page 2.2.97
Meters - Modulation Meters	View all Modulation level meters.	page 2.2.97
Meters - Timing Meters	View the transmitter's Timing Meters (10 MHz Delta and 1 PPS Accuracy).	page 2.2.98
Meters - Exciter PWB Voltage Meters	View the Exciter's Voltage meters.	page 2.2.98
Meters - Analog Audio PWB Voltage Meters	View the transmitter's Analog Audio voltage meters.	page 2.2.99
Meters - System Interface PWB Meters	View the System Interface's voltage meters.	page 2.2.99

FPUI Screen	Function	See page
Network	View and/or set network information such as MAC address (view only), DHCP on/off status, IP address, netmask and gateway.	page 2.2.100
Presets - Select	Select and activate a user-defined preset.	page 2.2.103
Presets - Edit	Edit the selected preset's parameters.	page 2.2.104
Presets - Create	Creates a new preset.	page 2.2.105
Presets - Clone	Saves a copy of an existing preset.	page 2.2.117
Presets - Delete	Deletes the selected preset.	page 2.2.118
Settings - System - Time	Allow the user to set edit Clock, Date and enable NTP.	page 2.2.120
Settings - System - Time - NTP Sync	Enables time to be NTP synchronized.	page 2.2.121
Settings - System - Time - Set Clock	Set time of day.	page 2.2.121
Settings - System - Time - Set Date	Set the date.	page 2.2.122
Settings - System - Transmitter Name	Edit the transmitter's name.	page 2.2.122
Settings - System - Display Brightness	Edit the brightness of the Front Panel UI.	page 2.2.123
Settings - System - Sleep Timer	Edit the Sleep Timer.	page 2.2.123
Settings - System - Orban Inside Present	Enable or Disable Orban Audio processor hardware.	page 2.2.124
Settings - Transmitter - Translator	Allows the transmitter to be used as a translator to re-broadcast primary information as a secondary station on an alternate frequency.	page 2.2.126
Settings - Transmitter - Signal Generator	Enable/disable and setup the internal signal generator.	page 2.2.127
Settings - Transmitter - Forward Low	Set the low forward power and very low forward power thresholds.	page 2.2.128
Settings - Transmitter - Exciter VCXO	Calibrate the internal clock to a user supplied external high precision 10 MHz clock reference.	page 2.2.130
Settings - Transmitter - Remote I/O	Configure the remote inputs, remote outputs, and analog outputs for the transmitter.	page 2.2.130
Settings - Transmitter - Calibration Menu	Set calibration values for various parameters (e.g., forward/ reflected power, program input levels, etc.).	page 2.2.133

FPUI Screen	Function	See page
Settings - Transmitter - Thresholds Menu	Set the SWR Shutdown and Foldback power thresholds.	page 2.2.134
Settings - Transmitter - Auto Bias Routine	Initiates the PA/IPA auto bias routine.	page 2.2.135
Settings - Transmitter - Turn-on Delay	Set the transmitter turn-on delay period.	page 2.2.136
Settings - Transmitter - Ramp-Up Speed	Set the transmitter's ramp-up speed.	page 2.2.136
Settings - Transmitter - Pilot Sample	Set the pilot sample level for the rear panel BNC connector.	page 2.2.137
Settings - Transmitter - FM Mask	Select the FM mask - FCC, ETSI or None (turns off mask).	page 2.2.137
Settings - Transmitter - Ext 10 MHz Input	Enable/disable the use of an external 10 MHz signal.	page 2.2.139
Settings - Transmitter - FM Polarity	Set the polarity for FM deviation; positive modulation signal yields positive frequency deviation or positive modulating signal yields negative frequency deviation.	page 2.2.139
Settings - Transmitter - Enable Scheduler	Enable and set up scheduler.	page 2.2.140
Software - Reboot Transmitter	Initiate a full system reboot (this will cause RF interruption).	page 2.2.142
Software - Restore	Restore the transmitter to original factory defaults.	page 2.2.142
Software - Unique Hardware ID	View the Unique Hardware ID of the transmitter.	page 2.2.143
Software - Firmware Revision	View the DSP, FPGA and SIB Firmware revisions.	page 2.2.142
Software - Nameplate License	Allow the user to enter a Nameplate License.	page 2.2.144

Alarms

When you select Alarms from the Main Menu (see [Figure 2.2.59](#)), you can view the various active alarms of the VX150 to VX2. These parameters can be displayed on multiple pages, depending on the amount of active alarms.

NOTE: This screen is for viewing purposes only and does not offer the same level of analytical features as the AUI's Reports page (see [Reports on page 2.2.77](#)).

Figure 2.2.59: Alarms Screen

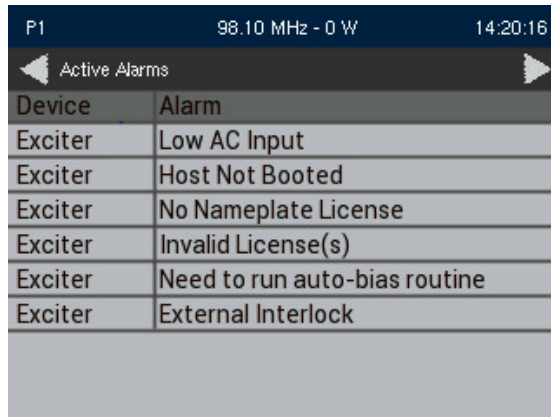

The screenshot shows the 'Active Alarms' screen. At the top, it displays 'P1', '98.10 MHz - 0 W', and '14:20:16'. Below this is a header 'Active Alarms' with left and right navigation arrows. The main content is a table with two columns: 'Device' and 'Alarm'.

Device	Alarm
Exciter	Low AC Input
Exciter	Host Not Booted
Exciter	No Nameplate License
Exciter	Invalid License(s)
Exciter	Need to run auto-bias routine
Exciter	External Interlock

View Alarms

The View Alarms screen displays only alarms that are currently active.

Use the front panel rotary knob to scroll through the list of alarms or events. Refer to the VX150 to VX2 Troubleshooting Manual to cross-reference the alarm name to possible causes and troubleshooting tips.

Reset Alarms

Press the Alarms Reset menu option in the front panel UI's Main Menu to attempt to clear any latching alarms that are holding the transmitter in an "off-air" state. Press Confirm to clear all alarms or Cancel to return to the previous menu. If the offending alarm has cleared, the transmitter should resume operation. See [Figure 2.2.60](#).

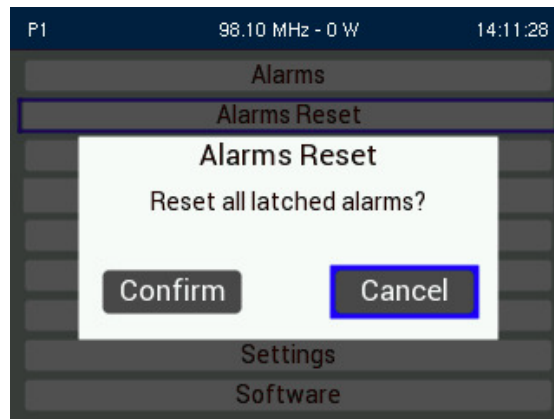
Figure 2.2.60: Alarms Reset screen

Logs

When you select Logs from the Main Menu (see [Figure 2.2.61 on page 2.2.93](#)), you can view all active or logged events, respectively, of the VX150 to VX2. These parameters can be displayed on multiple pages, depending on the amount of logs recorded.

Use the front panel rotary knob to scroll through the list of logged events. Refer to the VX150 to VX2 Troubleshooting Manual to cross-reference the alarm name to possible causes and troubleshooting tips.

NOTE: This screen is for viewing purposes only and does not offer the same level of analytical features as the AUI's Alarms page (see [Alarms on page 2.2.25](#)).

NOTE: Only logged alarms and events that have occurred since the last Exciter boot are displayed on the FPUI. A reboot or power cycle will clear any alarms displayed here. For complete logs see the remote AUI.

Figure 2.2.61: Logs screen

P1 98.10 MHz - 0 W 14:18:03		
Logs (1/4)		
Time	Description	
2020-07-05 13:24:57	Low AC Shutback Exciter	Cleared
2020-07-05 13:24:57	RF On/Off Exciter	Off
2020-07-05 13:24:53	Low AC Shutback Exciter	Triggered
2020-07-05 13:24:53	RF On/Off Exciter	On

Reset Logs

Press the Logs Reset menu option in the front panel UI's Main Menu. Press Confirm to clear all logs or Cancel to return to the previous menu. See [Figure 2.2.62](#).

NOTE: Clearing the front panel UI's logs does not clear the logs displayed in the remote AUI.

Figure 2.2.62: Clear Logs screen

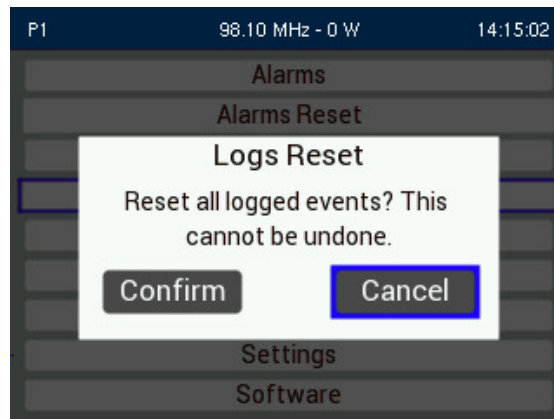

Meters

When you select Meters from the Main Menu, you can view various metered parameters of the VX150 to VX2. The meters are divided into the following sub-menus:

- Critical Meters (see [page 2.2.95](#))
- PA Meters (see [page 2.2.95](#))
- RF Drive Meters (see [page 2.2.96](#))
- Cooling System Meters (see [page 2.2.97](#))
- Modulation Meters (see [page 2.2.97](#))
- Timing Meters (see [page 2.2.98](#))
- Exciter PWB Voltage Meters (see [page 2.2.98](#))
- Analog Audio PWB Voltage Meters (see [page 2.2.99](#))
- System Interface PWB Meters (see [page 2.2.99](#))

Critical Meters

Select Critical Meters from the Front Panel UI's Meters menu to view the list of transmitter's critical power related meters. See [Figure 2.2.63](#).

Figure 2.2.63: Critical Meters

P1 98.10 MHz - 149 W 10:32:18		
Critical Meters (1/10)		
Meter	Value	
Forward Power	150 W	
Reflected Power	0.1 W	
VSWR	1.04	
Peak Modulation	0.17 %	
Average PA DC Voltage	20.4 V	
Total PA DC Current	10.6 A	
DC-RF Efficiency	69.6 %	
PS AC Input Voltage	126 V	

PA Meters

Select PA Meters from the Front Panel UI's Meters menu to view the list of transmitter's critical power amplifier related meters. See [Figure 2.2.64](#).

Figure 2.2.64: PA Meters

P1 98.10 MHz - 150 W 10:42:47		
PA Meters (2/10)		
Meter	Value	
PA Volts	20.4 V	
PA Current	10.64 A	
PA Dissipation	69.36 W	
PA Bias	3.692 V	

RF Drive Meters

Select RF Drive Meters from the front panel UI's Meters menu to view a list of the transmitter's RF drive related meters. See [Figure 2.2.65](#).

Figure 2.2.65: RF Drive Meters

Meter	Value
IPA Forward Power	3.0 W
IPA Volts	12.0 V
IPA Current	0.98 A
IPA Bias	2.985 V
RF DAC Gain	1.861

Cooling System Meters

Select Cooling System Meters from the front panel UI's Meters menu to view a list of the transmitter's cooling related meters. See [Figure 2.2.66](#).

Figure 2.2.66: Cooling System Meters

Meter	Value
Inlet Temp	25.0 C
Heatsink Temp	24.6 C
Fan 1 Speed	0 RPM
Fan 2 Speed	0 RPM

Modulation Meters

Select Modulation Meters from the front panel UI's Meters menu to view a list of transmitter's modulation related meters. See [Figure 2.2.67](#).

NOTE: Any meters for digital signal inputs that are not connected will display "N/A".

Figure 2.2.67: Modulation Meters

Meter	Value
Analog Left	-65.74 dBu
Analog Right	-67.40 dBu
Digital 1 Left	N/A
Digital 1 Right	N/A
Digital 2 Left	N/A
Digital 2 Right	N/A
Digital 1 DMPX	-90.0 dBFS
Digital 2 DMPX	-90.0 dBFS

Meter	Value
MPX RMS Deviation	-45.28 dB
MPX1 Peak	0.003 Vpp
MPX2 Peak	0.004 Vpp

Timing Meters

Select Timing Meters from the front panel UI's Meters menu to view a list of transmitter's timing related meters. See [Figure 2.2.68](#).

NOTE: Two drawings are shown for reference in [Figure 2.2.68](#) because External 10 MHz and 1 PPS inputs cannot be enabled at the same time.

Figure 2.2.68: Timing Meters

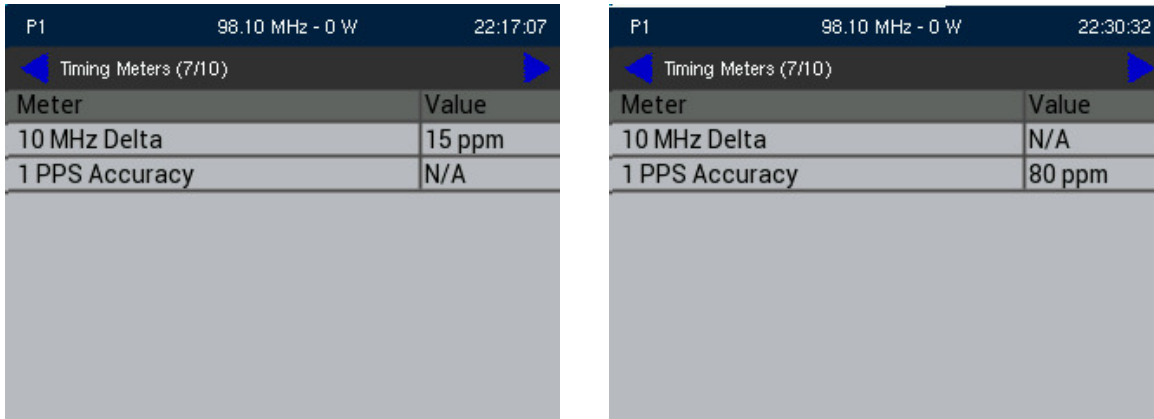

Exciter PWB Voltage Meters

Select Exciter PWB Voltage Meters from the front panel UI's Meters menu to view a list of the Exciter's voltage related meters. See [Figure 2.2.69](#).

Figure 2.2.69: Exciter PWB Voltage Meters

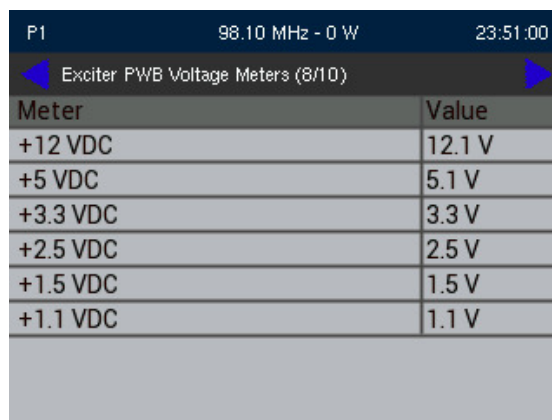

Analog Audio PWB Voltage Meters

Select Analog Audio PWB Voltage Meters from the front panel UI's Meters menu to view a list of transmitter's analog audio voltage related meters. See [Figure 2.2.70](#).

Figure 2.2.70: Analog Audio PWB Voltage Meters

Meter	Value
+12 VDC	11.9 V
+8 VDC	8.1 V
-8 VDC	-8.2 V
+5 VDC	5.0 V

System Interface PWB Meters

Select System Interface PWB Meters from the front panel UI's Meters menu to view a list of transmitter's System Interface related meters. See [Figure 2.2.71](#).

Figure 2.2.71: System Interface PWB Meters

Meter	Value
+12 VDC	12.1 V
+3.3 VDC	3.3 V

Network

CAUTION!

When connecting to a Nautel transmitter, we support both HTTP and HTTPS protocols. If using HTTP, the data traffic is not encrypted, meaning your username/password could be compromised. For security reasons, Nautel recommends using HTTPS whenever possible.

You can only configure network settings using the local front panel UI. If you change a network setting on the front panel UI, it will also be reflected on the remote AUI.

NOTE: Nautel recommends that network settings be entered/vetted by a qualified Network Administrator. If parameters are changed and the AUI is reset, record the new values (or see the local front panel UI) to ensure you can log in after changes are made.

Determining DHCP Setting

One of the main decisions in configuring the network connection on your VX150 to VX2 transmitter is whether you set DHCP to ON or OFF. If you are connecting to a network, consult with a network administrator before connecting the transmitter to your network to determine whether to enable (turn ON) or disable (turn OFF) the DHCP setting.

When DHCP is set to ON (default from factory), IP addresses are assigned automatically by the network server. In order for this feature to function properly, you must have a network-viewable DHCP server on your network.

If a DHCP server is not present, you (or your network administrator) must provide static addresses for IP, netmask, gateway and DNS servers (gateway and DNS servers are optional). You must enter them manually using the transmitter's front panel. In this case, DHCP should be set to OFF.

NOTE: A DNS server (also called a Nameserver) translates a host name (e.g., mail.nautel.com) to an IP address such as in configuring email.

NOTE: If DHCP is enabled, all other Network settings on the FPUI will be grayed out (not user configurable).

Network Setup - Using the Front Panel

From the transmitter's front panel, in local mode, you can set or change network settings. Select Network from the main menu. See [Figure 2.2.72](#) for values provided by the DHCP server (values shown are examples only).

Use the Front Panel rotary knob to move the cursor to the desired parameter and then press to enable editing of the setting. Within any of the editing screens, use the Front Panel rotary knob to edit. Press the Back button to discard changes and return to the previous menu.

If you are using a laptop to connect to the VX150 to VX2, see [Connecting a Laptop Directly to the Transmitter on page 2.2.101](#).

Figure 2.2.72: Network Screen (DHCP On)

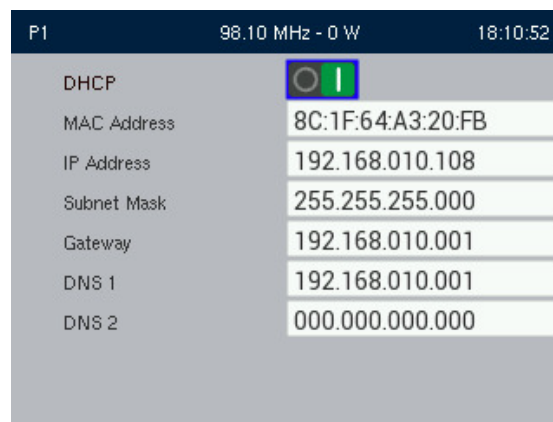

Connecting a Laptop Directly to the Transmitter

If connecting to the VX150 to VX2 directly with a laptop, you must set a static IP address on the VX150 to VX2 and your laptop.

1. From the Front Panel UI, go to Network and set the IP address as follows:
 - DHCP: OFF
 - IP Address: 10.10.10.2
 - Netmask: 255.255.255.0
2. Set the transmitter for Remote control.

NOTE: The following steps assume the operating system is Windows 10 or newer. Adapt as required for computers with different operating systems.

3. On the laptop, go to Start Menu/Control Panel/Network Connections/Local Area Network.

4. In the Local Area Network Status, open the General tab and choose Properties. Scroll down and highlight Internet Protocol (TCP/IP). Choose Properties.
5. In the Internet Protocol (TCP/IP) Properties window, select Use the following IP address.
6. Enter the following settings:
 - IP Address: 10.10.10.1
 - Subnet Mask: 255.255.255.0
7. In the Internet Protocol (TCP/IP) Properties window, select OK.
8. In the Local Area Connection Properties window, select OK.
9. In the Local Area Connection Status window, select Close.
10. Close the Network Connections window.

Presets

Many preset settings available on the front panel UI are also available on the remote AUI. In this case, if you change a preset setting on the front panel UI, it will also be reflected on the remote AUI, and vice versa. The Presets menu has five sub-menus (see [Figure 2.2.73](#)):

- Select (see [page 2.2.103](#))
- Edit (see [page 2.2.104](#))
- Create (see [page 2.2.117](#))
- Clone (see [page 2.2.117](#))
- Delete (see [page 2.2.118](#))

Figure 2.2.73: Presets Screen

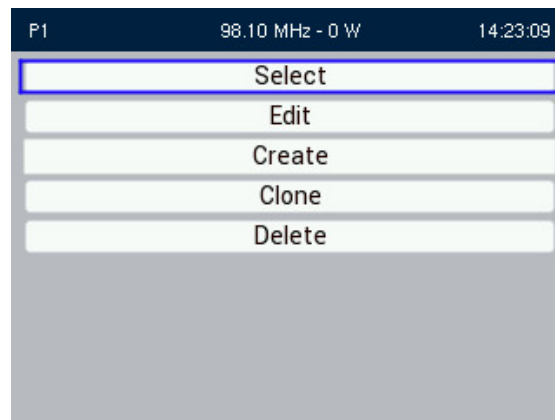

Select Preset

When you choose Select Preset from the Main Menu (see [Figure 2.2.74 on page 2.2.104](#)) you can select the active preset for transmitter operation.

NOTE: In [Figure 2.2.74 on page 2.2.104](#), the active/on air preset is indicated by the green checkmark. Any changes to this preset affect the on air signal.

Figure 2.2.74: Select Preset

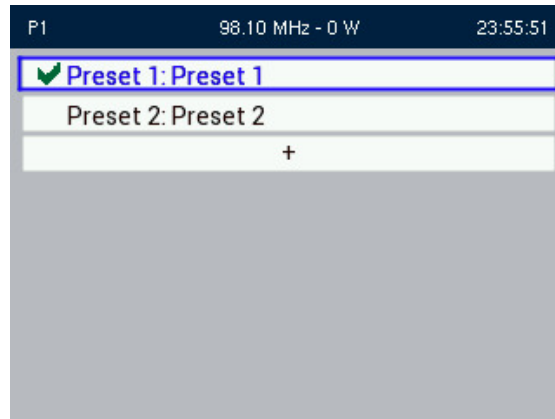

Use the Front Panel rotary knob to scroll through the existing presets. Press the Front Panel rotary knob to enable the preset as the transmitter’s active preset. Press the Back button to return to the previous menu.

NOTE: In [Figure 2.2.74](#), pressing the “+” button will create a new preset. Refer to [Create Preset on page 2.2.117](#) for details on creating presets.

Edit Preset

When you select Edit Presets from the Presets menu (see [Figure 2.2.75](#)) you can create up to 62 operating presets or edit existing presets.

NOTE: The Preset Name is a view only field in the FPUI. Editing the Preset Name can only be done using the Remote AUI (see [Managing Presets - Using the AUI on page 2.2.28](#)).

Figure 2.2.75: Edit Preset

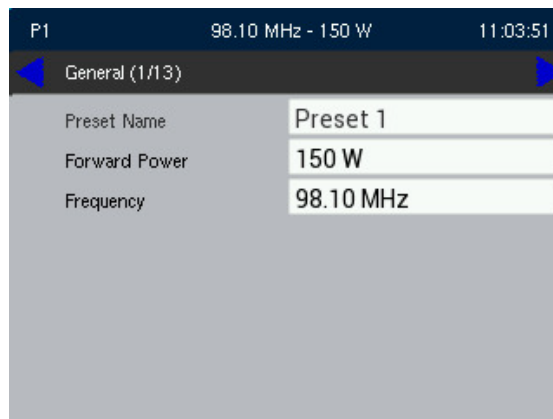

General

There are two menu options under the General heading: Forward Power and Frequency (see [Figure 2.2.75](#)). Use the Front Panel rotary knob to select desired setting and press the Front Panel rotary knob to enabled editing. Press the Cancel button to discard the change and return to the previous menu.

NOTE: The Preset name is greyed out in the FPUI and is not editable, to change the Preset name refer to [Editing or creating presets using the AUI on page 2.2.29](#).

Forward Power. See [Figure 2.2.76](#). Use the Front Panel rotary knob to edit the forward power and press the Save button to save the change. Press the Cancel button to discard the change and return to the previous menu.

The maximum power settings are as follows:

VX150 - 165 W, VX300 - 330 W, VX600 - 660 W, VX1 - 1200 W, VX1,5 - 1650, VX2 - 2100 W

The minimum power settings are as follows:

VX150 - 15 W, VX300 - 30 W, VX600 - 60 W, VX1 - 100 W, VX1.5 - 150, VX2 - 200 W

Figure 2.2.76: Edit Preset - Forward Power



VX300 display shown for reference

Frequency. See [Figure 2.2.77](#). Use the Front Panel rotary knob to edit the frequency and press the Save button to save the change. Press the Cancel button to discard the change and return to the previous menu.

Figure 2.2.77: Edit Preset - Frequency

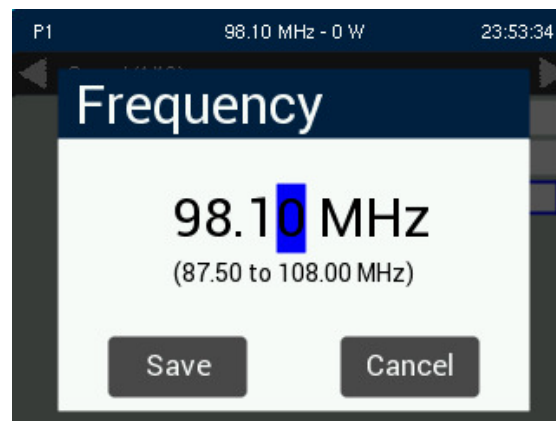

Main Audio. When you enter the Main Audio heading, you can edit various main audio parameters (see [Figure 2.2.78 on page 2.2.106](#)). Use the Front Panel rotary knob to edit the option and press the Front Panel rotary knob to save the change. Press the Back button to return to the previous menu.

Figure 2.2.78: Edit Preset - Main Audio

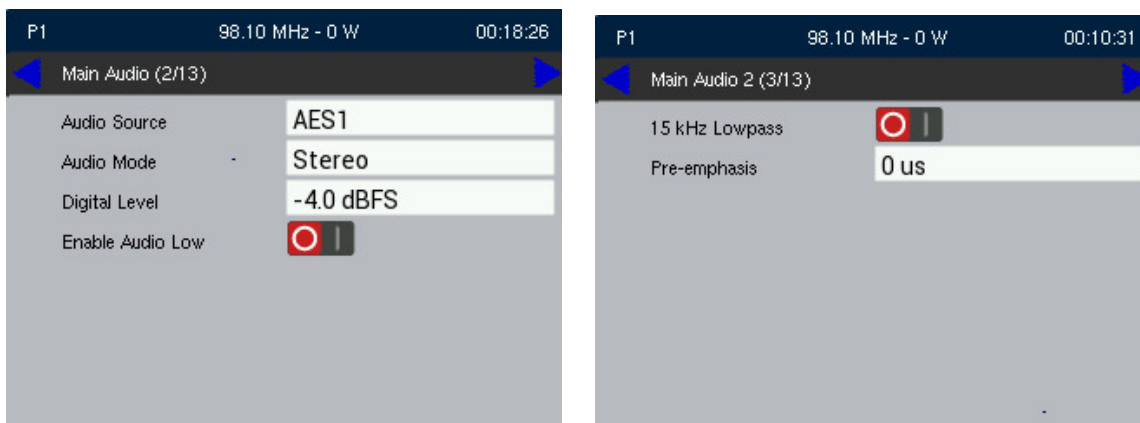

- **Audio Source:** Use the Front Panel rotary knob to edit the desired audio source - AES1/2, MPX1/2, DMPX AES1/2 or Analog L/R and press the Front Panel rotary knob to save the change. Press the Back button to discard the change and return to the previous menu.
- **Stereo Mode:** Use the Front Panel rotary knob to edit the desired audio mode - Left Mono, Right Mono, L+R Mono or Stereo and press the Front Panel rotary knob to save the change. Press the Back button to discard the change and return to the previous menu.

- **Input Levels:** Use the Front Panel rotary knob to edit the desired audio level, noting the minimum and maximum limitations indicated at the bottom of the display. Press the Front Panel rotary knob to save the change. Press the Back button to discard the change and return to the previous menu.
- **Enable Audio Low:** Use the Front Panel rotary knob to move the slider to the right (enabled). This will open two additional options. Set the Audio Low Timeout to the desired value (allowable range is 1 to 600 seconds). Set the Audio Low Threshold to the desired value, below which the transmitter will take action. The allowable range is determined by the audio source. If the applicable audio source level falls below the trip level setting for longer than the timeout setting, an alarm will activate in the Alarms page. When the audio source level increases above the trip level, the alarm will clear. If a backup audio source has been configured the audio low alarm will cause a switch to the backup audio source. If the alarm is cleared (main audio has returned for at least 1 second) then the transmitter will automatically switch back to main audio. Use the Front Panel rotary knob to edit the desired parameter and press the Front Panel rotary knob to save the change. Press the Back button to discard the change and return to the previous menu.
- **Low Pass Filter:** Use the Front Panel rotary knob to move the slider to the right (enabled). Press the Back button to discard the change and return to the previous menu.
- **Pre-emphasis:** Use the Front Panel rotary knob to edit the desired Pre-emphasis characteristic - 0 us, 50 us or 75 us and press the Front Panel rotary knob to save the change. Press the Back button to discard the change and return to the previous menu.

Backup Audio. When you select the Backup Audio heading from the Edit Preset screen, you can enable a backup audio source and edit various backup audio parameters. See [Figure 2.2.79](#).

Use the Front Panel rotary knob to scroll through the backup audio menu options, then press the Front Panel rotary knob to enter the selected editing screen. With the exception of the Enable screen (move slider to the right to enable), the editing screens for the Backup Audio menu are the same as the Main Audio menu. Press the Back button to discard the change and return to the previous menu.

Figure 2.2.79: Edit Preset - Backup Audio

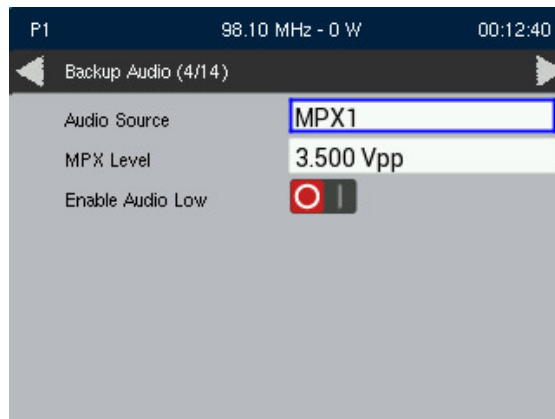

NOTE: If you edit and save the Backup Audio settings after the transmitter switches over to the backup audio source due to a main audio source failure, the transmitter will switch back to the main audio source. If the main audio source is still in a failure state, the transmitter will switch back to the backup audio source, after the selected timeout period.

SCA Settings. When you select the SCA Settings heading from the Edit Preset screen, you can edit various SCA parameters (see [Figure 2.2.80](#)).

Figure 2.2.80: Edit Preset - SCA Settings

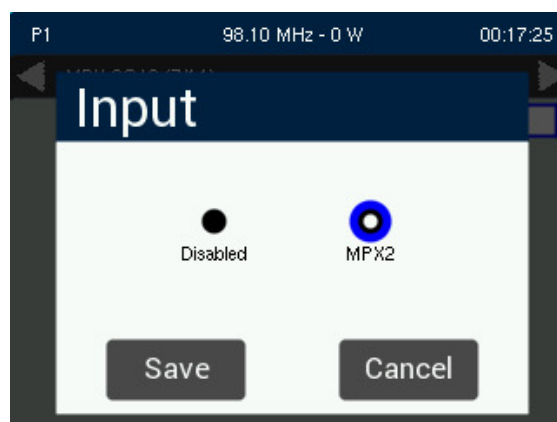

Use the Front Panel rotary knob to scroll through the desired SCA settings, then press the Front Panel rotary knob to enable editing of the parameter. Within any of the editing screens, use the Front Panel rotary knob to edit or toggle a parameter value, noting the minimum and maximum limitations indicated at the bottom of the display. When complete, press the Front Panel rotary knob to save the change. Note: If you select Internal SCA1 or Internal SCA2, there is a sub-menu that contains additional SCA settings. Press the Back button to discard any changes and return to the previous menu.

Note the following SCA options:

- MPX SCAs: Select enabled or disabled.
- MPX SCA Input: Select a level between 1 and 5 V peak-to-peak (when MPX SCAs is ON).
- Int. SCA1 or Int. SCA2.
- SCA Enable: Select enabled or disabled.
- SCA Level: Select a level between 0 and 20%.
- SCA Freq: Select a frequency between 20 and 100 kHz.
- SCA Input: Select a level between -12 and 12 dBu.
- SCA Low Pass: Select enabled or disabled.
- SCA Preemph: Select the desired pre-emphasis characteristic - 0 us, 50 us or 75 us.
- SCA Mode: Select FM or DSB-SC.

Modulation Loss. When you select the Modulation Loss heading from the Edit Preset screen, you can edit parameters related to a modulation loss. See [Figure 2.2.81](#).

Figure 2.2.81: Edit Preset - Modulation Loss



Use the Front Panel rotary knob to scroll through the desired Mod Loss settings, then press the Front Panel rotary knob to enable editing of the parameter. Within any of the editing screens, use the Front Panel rotary knob to edit or toggle a parameter value, noting the minimum and maximum limitations indicated at the bottom of the display. When complete, press the Front Panel rotary knob to save the change. Press the Back button to discard any changes and return to the previous menu.

Note the following Modulation Loss options:

- **Enable:** Determines whether the modulation loss feature is used. Select Enabled or Disabled.
- **Timeout Minutes:** Sets the time period of low audio (based on the threshold setting) after which the transmitter will take action. Select a value between 0 and 255 minutes.
- **Timeout Seconds:** Sets the time period of low audio (based on the threshold setting) after which the transmitter will take action. Select a value between 0 and 60 seconds.
- **Threshold:** Sets the modulation threshold below which the transmitter will take action. Select a value between 0 and 100%.
- **Reaction:** Determines the action taken by the transmitter when the modulation has been below the threshold for the timeout period. Select Alarm Only, RF Inhibit or Switch Preset.
- **Preset:** Determines the preset that becomes active after a modulation loss if the modulation loss reaction is set to Switch Preset.

Pilot and Delay Settings. When you select the Pilot and Delay heading from the Edit Preset screen, you can edit the settings of the pilot signal (see [Figure 2.2.82](#)).

Figure 2.2.82: Edit Preset - Pilot Settings



Use the Front Panel rotary knob to scroll through the desired Pilot settings, then press the Front Panel rotary knob to enable editing of the parameter. Within any of the editing screens, use the Front Panel rotary knob to edit or toggle a parameter value, noting the minimum and maximum limitations indicated at the bottom of the display. When complete, press the Front Panel rotary knob to save the change. Press the Back button to discard any changes and return to the previous menu.

Note the following Pilot parameters:

- Level: Select an Injection Level between 6 and 12%.
- 1 PPS Sync: Select ON or OFF.
- Pilot 1 PPS Phase: Select a phase angle between 0 and 360 degrees.
- Audio Delay Enable: When enabled, set the desired Audio Delay Time (allowable range is 0 to 20 seconds).

Limiter Settings. When you select the Limiter heading from the Edit Preset screen, you can edit various limiter parameters (see [Figure 2.2.83 on page 2.2.112](#) and [Figure 2.2.84 on page 2.2.112](#)).

Use the Front Panel rotary knob to scroll through the desired Limiter settings, then press the Front Panel rotary knob to enable editing of the parameter. Within any of the editing screens, use the Front Panel rotary knob to edit or toggle a parameter value, noting the minimum and maximum limitations indicated at the bottom of the display. When complete, press the Front Panel rotary knob to save the change. Press the Back button to discard any changes and return to the previous menu.

Use the Front Panel rotary knob to move the cursor to the desired limiter and then press the Front Panel rotary knob to enter the associated sub-menu for:

- L/R Limiter: See [Figure 2.2.83 on page 2.2.112](#). Adjust the L/R Limiter Max Gain, Decay Time and Hold Time as desired.
- Hard Limiter: See [Figure 2.2.83 on page 2.2.112](#). Adjust the Hard Limiter Level as desired.

NOTE: The Hard Limiter does not affect the RDS or Pilot components of an output signal.

Figure 2.2.83: L/R/Hard Limiter Sub-menu



- AGC Limiter: See [Figure 2.2.84](#). Adjust the AGC Limiter Level and Decay Time as desired.
- MPX Power Limiter: See [Figure 2.2.84](#). Adjust the MPX Power Limiter Level as desired.

Figure 2.2.84: AGC/MPX Limiter Sub-menu

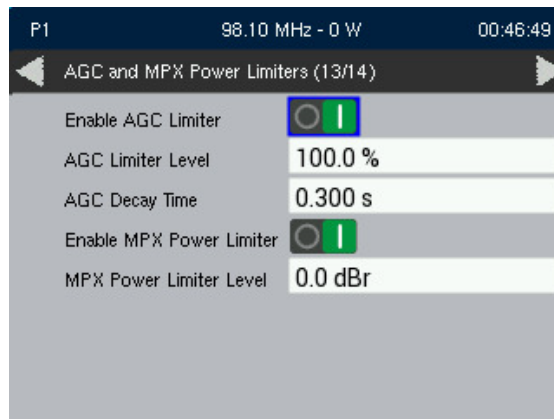

RDS Settings. When you enable RDS from the Edit Preset screen, you can edit various RDS parameters.

If you change a preset setting on the Front Panel UI, it will also be reflected on the Remote AUI, and vice versa.

NOTE: RDS Settings have been described in detail in the remote AUI section. See [RDS on page 2.2.35](#) for more information.

Use the Front Panel rotary knob to enable RDS, then press the Front Panel rotary knob to save the change. See [Figure 2.2.85](#). Once RDS is enabled, two sub-menu screens are activated that allow the user to enable/edit other features. See [Figure 2.2.86](#). Use the Front Panel rotary knob to scroll through the desired RDS settings, then press the Front Panel rotary knob to enable editing of the parameter. Within any of the editing screens, use the Front Panel rotary knob to edit or toggle a parameter value. When complete, press the Front Panel rotary knob to save the change. Press the Back button to discard any changes and return to the previous menu.

Figure 2.2.85: RDS Enabled

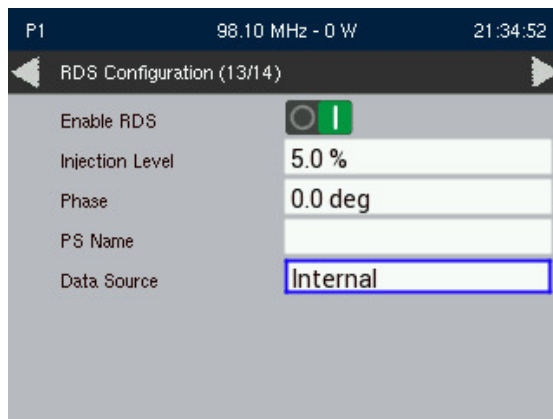
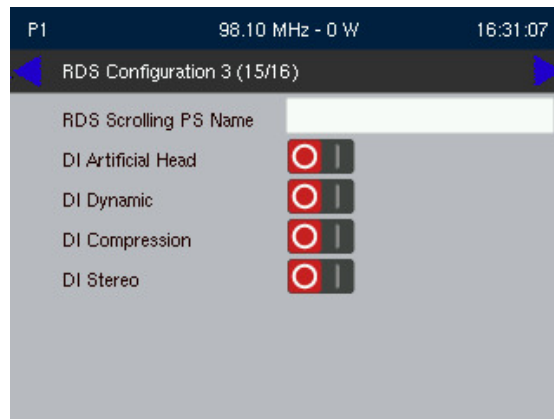
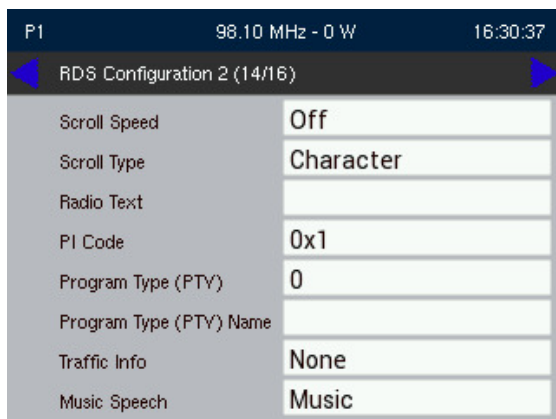

Figure 2.2.86: RDS Enabled - Sub-menus



Use the Front Panel rotary knob to select the desired RDS Data Source option and then press the Front Panel rotary knob to enter the associated sub-menu, noting the minimum and maximum limitations indicated at the bottom of the display (if applicable) for:

- Internal RDS (see [Figure 2.2.85 on page 2.2.113](#)), set the RDS Injection Level (allowable range is 0 to 10%).

- RDS Phase (see [Figure 2.2.86 on page 2.2.113](#)), set the RDS Phase level (allowable range is 0 to 10 degrees).
- RDS PS Name (see [Figure 2.2.86 on page 2.2.113](#)), enter a RDS PS Name (allowable range is 0 to 10%).

Other RDS Data sources are as follows:

- ASCII over IP (see [Figure 2.2.87](#)). Set the Injection Level.

Figure 2.2.87: ASCII over IP

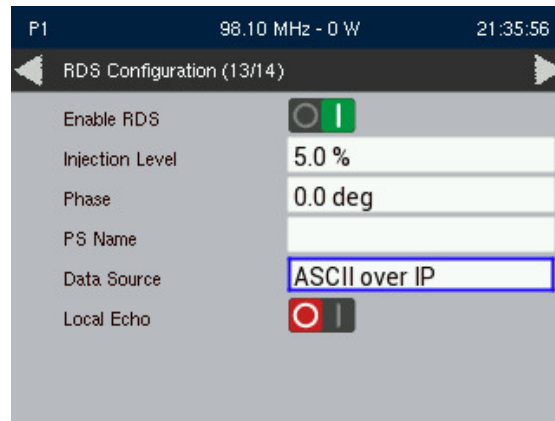

- ASCII over Serial (see [Figure 2.2.88](#)). Enable Local Echo and set Baud Rate as desired (allowable range 0 to 115200 bps).

Figure 2.2.88: ASCII over Serial

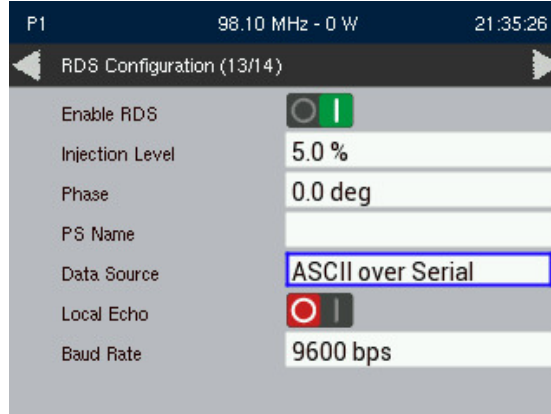

- UECP over IP (see [Figure 2.2.89](#)). Set the Injection Level.

Figure 2.2.89: UECP over IP

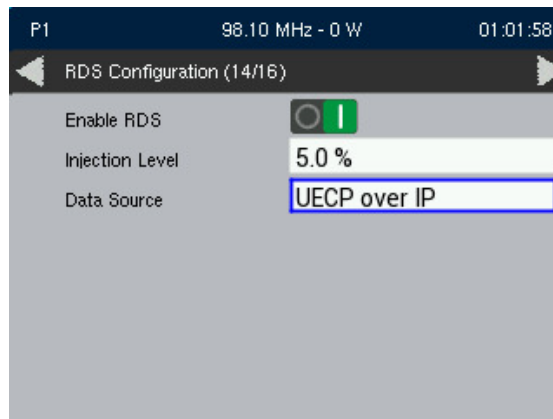

- UECP over Serial (see [Figure 2.2.90](#)). Set Baud Rate as desired (allowable range 0 to 115200 bps).

Figure 2.2.90: UECP over Serial

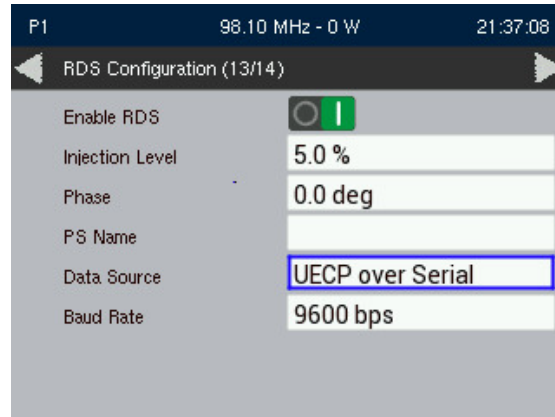

Audio Processor Settings. When you select the Audio Processor heading from the Edit Preset screen, you can set the Audio Processor’s preset (see [Figure 2.2.91](#)).

Figure 2.2.91: Edit Preset - Audio Processor Settings

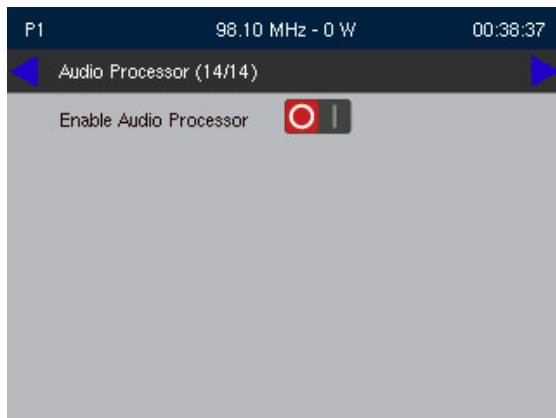

Audio Processor shown Disabled



Audio Processor shown Enabled

Use the Front Panel rotary knob to enable the Audio Processor, then press the Front Panel rotary knob to save the change. Within the enabled screen, use the Front Panel rotary knob to select the Audio Processor’s active preset. When complete, press the Front Panel rotary knob to save the change. Press the Back button to discard any changes and return to the previous menu.

Create Preset

Use the Front Panel rotary knob to select Create Preset from the Preset menu. See [Figure 2.2.92](#). Within any of the editing screens, use the Front Panel rotary knob to edit or toggle a parameter value. The same parameters are found in the Edit Preset section (refer to [Edit Preset on page 2.2.104](#)). When you create a new preset, the next available preset number is assigned (e.g., Preset 5). When complete, press the Front Panel rotary knob to save the change. Press the Back button to discard any changes and return to the previous menu.

Figure 2.2.92: Create Preset

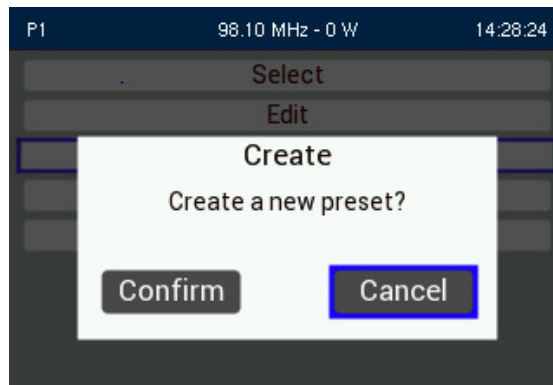

Clone Preset

Use the Front Panel rotary knob to select Clone Preset from the Preset menu. Select a preset to clone from the Preset list by using the Front Panel rotary knob. See [Figure 2.2.93 on page 2.2.117](#). Within any of the editing screens, use the Front Panel rotary knob to edit or toggle a parameter value. The same parameters are found in the Edit Preset section (refer to [Edit Preset on page 2.2.104](#)). When you clone a preset, the next available preset number is assigned (e.g., Preset 5). When complete, press the Front Panel rotary knob to save the change. Press the Back button to discard any changes and return to the previous menu.

Figure 2.2.93: Clone Preset



Delete Preset

Use the Front Panel rotary knob to select Delete Preset from the Preset menu. Select a preset to delete from the Preset list by using the Front Panel rotary knob. See [Figure 2.2.94](#). When complete, press the Front Panel rotary knob to save the change. Press the Back button to discard any changes and return to the previous menu.

NOTE: The active preset, any presets used for Remote I/O, Modulation Loss or has the Scheduler enabled cannot be deleted.

Figure 2.2.94: Delete Preset

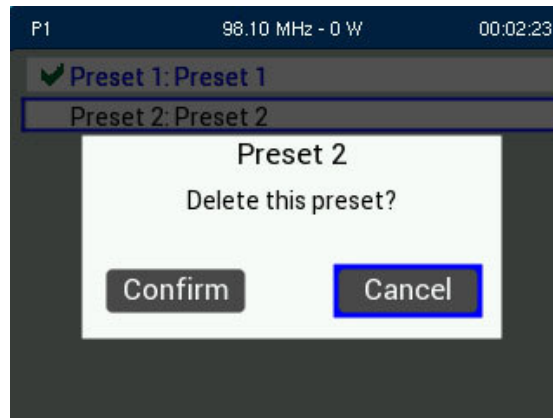

Settings

The Settings menu is divided into two main categories (see [Figure 2.2.95](#)):

- System
- Transmitter (see [page 2.2.125](#))

Figure 2.2.95: Settings Menu

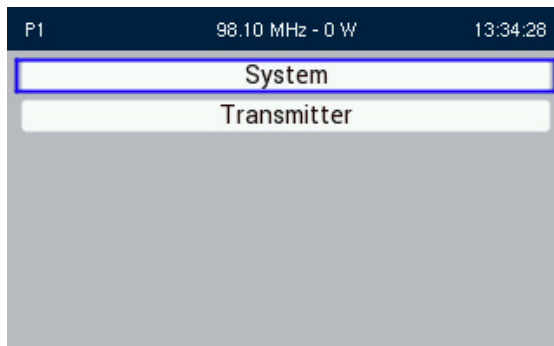

System Settings

Select the System settings menu (see [Figure 2.2.96 on page 2.2.120](#)) to allow the user to edit/change the following criteria:

- Time (see [page 2.2.120](#))
 - NTP Sync (see [page 2.2.121](#))
 - Set Clock (see [page 2.2.121](#))
 - Set Date (see [page 2.2.122](#))
- Transmitter Name (see [page 2.2.122](#))
- Display Brightness (see [page 2.2.123](#))
- Sleep Timer (see [page 2.2.123](#))
- Orban Inside Present (see [page 2.2.124](#))

Figure 2.2.96: System Settings

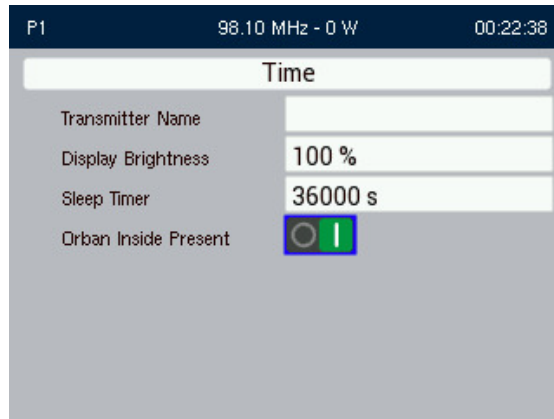

Time

The Time menu allows the user to enable NTP, set the time, and set the date. Use the Front Panel rotary knob to select the option and press the knob to enter the editing menu. Press the Back button to discard the changes and return to the previous setting. See [Figure 2.2.97](#).

NOTE: The clock and date will need to be set if an “Invalid Date and Time” alarm appears on the FPUI or AUI.

Figure 2.2.97: System - Time

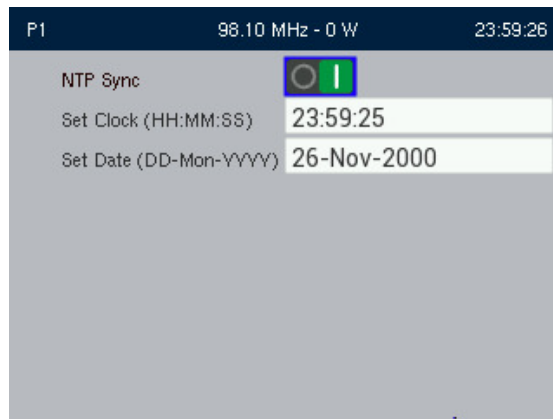

NTP Sync

If the NTP Sync feature is enabled (see [Figure 2.2.97 on page 2.2.120](#)), the clock will set automatically to a network time server and cannot be manually adjusted.

Use the Front Panel rotary knob to edit the slider setting to Enabled (I) and press the Front Panel rotary knob to select. Press the Back button to return to the previous setting.

Set Clock

When you select Settings -> System -> Time -> Set Clock, you can set the current time.

To set the clock, use the Front Panel rotary knob to edit the hours, minutes and seconds. Press the Front Panel rotary knob to save the changes. Press the Back button to return to the previous setting. See [Figure 2.2.98](#).

The date and time needs to be set when the transmitter is first powered on, or after a prolonged power outage (the transmitter’s clock will operate for a minimum of 24 hours with no Ac power).

You can set the time using the Remote AUI (see [Time on page 2.2.64](#)). If you change the clock setting on the Front Panel UI, it will also be reflected on the remote AUI, and vice versa.

Figure 2.2.98: Set Clock

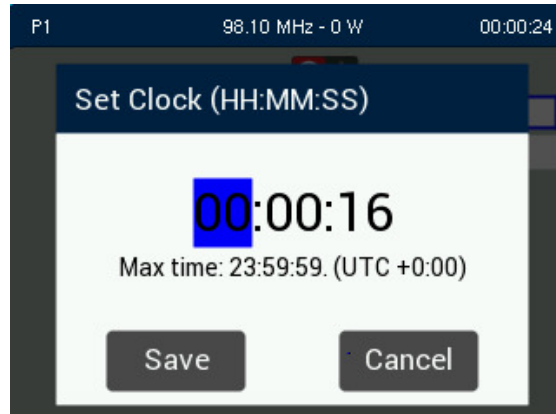

Set Date

To set the date, use the Front Panel rotary knob to edit the day, month and year. Press the Front Panel rotary knob to save the changes. Press the Back button to return to the previous setting. See [Figure 2.2.99](#).

Figure 2.2.99: Set Date

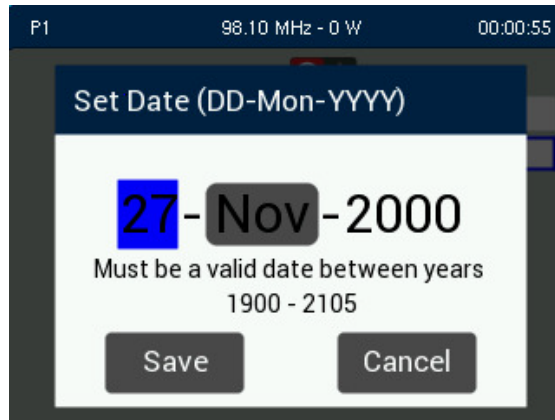

Transmitter Name

To enter a Transmitter Name, use the Front Panel rotary knob to select the characters for the user defined transmitter name. Press the Front Panel rotary knob to save the changes. Press the Back button to discard the changes and return to the previous setting. See [Figure 2.2.100](#).

Figure 2.2.100: Transmitter Name

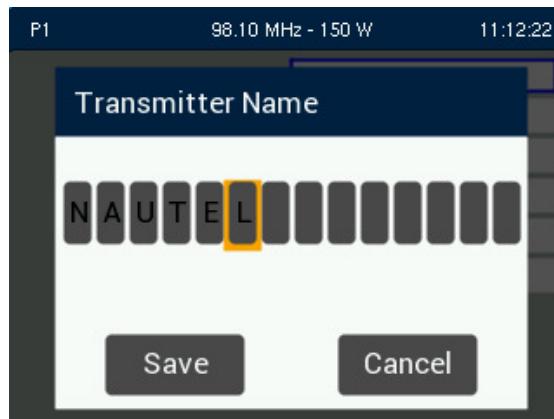

Display Brightness

Allows the user to adjust the front panel's brightness level. Use the Front Panel rotary knob to edit the brightness level and press the Front Panel rotary knob to save the changes. Press the Back button to return to the previous setting. See [Figure 2.2.101](#). Default level is set to 100%.

Figure 2.2.101: Display Brightness

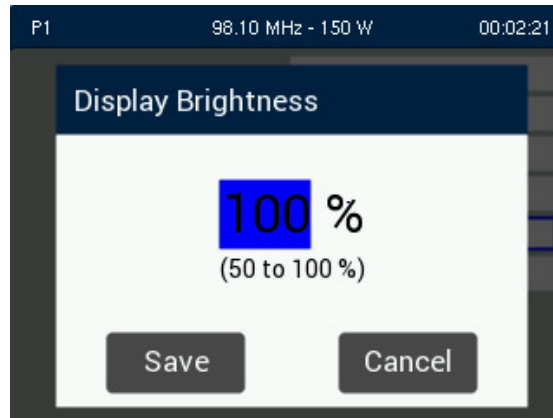

Sleep Timer

Allows the user to set a timer that turns off the front panel display after a period of user inactivity. The settable range for the timer is 200 - 36000 seconds (3 mins, 20 sec to 600 mins). (See [Figure 2.2.102](#)). Use the Front Panel rotary knob to edit the timer setting in seconds and press the Front Panel rotary knob to save the change. Press the Back button to return to the previous setting.

Figure 2.2.102: Sleep Timer

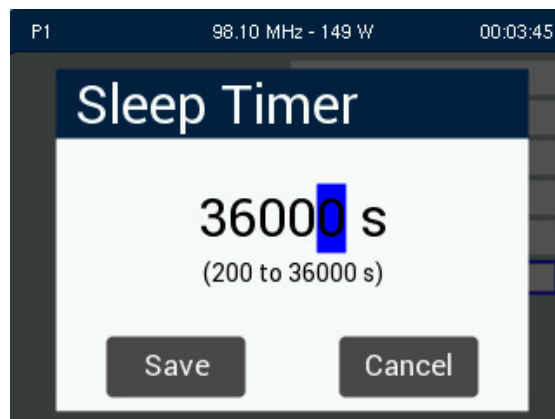

Orban Inside Present

NOTE: *When an Orban audio processor is factory installed in a transmitter, Orban is disabled by default.*

If an Orban audio processor is installed, use the Front Panel rotary knob to edit the slider setting to I (enabled) and press the Front Panel rotary knob to select. See [Figure 2.2.103](#). The icon will be green when enabled. Press the Back button to return to the previous setting. Cycle (turn off, then on) the transmitter’s ac power to allow the AUI to properly detect the Orban Inside Present setting change.

Enabling Orban Inside Present grants access to the Audio Processor sub-menus where it can be configured (see [Audio Processor Settings on page 2.2.116](#)).

Figure 2.2.103: Orban Inside Present

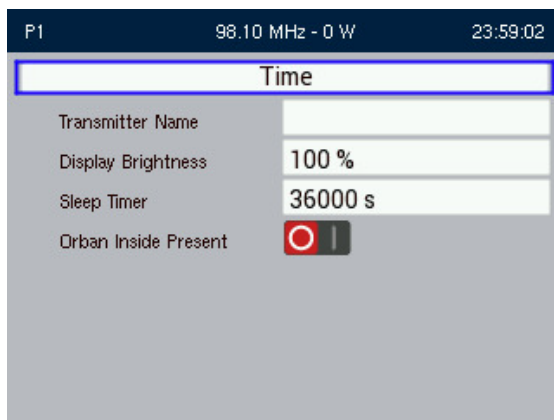

Orban Inside shown Disabled



Orban Inside shown Enabled

Transmitter Settings

WARNING!
CALIBRATION SETTINGS ARE ESTABLISHED AT NAUTEL AND SHOULD NOT REQUIRE ANY ADJUSTMENT. MAKING CHANGES TO THESE SETTINGS MAY VOID YOUR WARRANTY. CONTACT NAUTEL BEFORE MAKING CHANGES.

Selecting the Transmitter settings menu (see [Figure 2.2.104 on page 2.2.126](#)) allows the user to edit/change the following criteria:

- Translator (see [page 2.2.126](#))
- Signal Generator (see [page 2.2.127](#))
- Forward Low (see [page 2.2.128](#))
- Exciter VCXO (see [page 2.2.130](#))
- Remote I/O (see [page 2.2.130](#))
- Calibration Menu (see [page 2.2.133](#))
- Threshold Menu (see [page 2.2.134](#))
- Auto-Bias Routine (see [page 2.2.135](#))
- Turn-on Delay (see [page 2.2.136](#))
- Ramp-up Speed (see [page 2.2.136](#))
- Pilot Sample (see [page 2.2.137](#))
- FM Mask (see [page 2.2.137](#))
- FM Polarity (see [page 2.2.140](#))
- Ext 10 MHz Input (see [page 2.2.139](#))
- Enable Scheduler (see [page 2.2.140](#))

Figure 2.2.104: Transmitter Settings



Translator

To enable the Translator function, select Translator from the Settings Menu. In certain applications, the VX150 to VX2 may be used as a translator to re-broadcast primary information as a secondary station on an alternate frequency. To allow the secondary station to be identified, you can set station ID parameters such as call sign, FSK polarity, deviation and repeat interval.

See [Figure 2.2.105 on page 2.2.127](#). Use the Front Panel rotary knob to edit the slider setting to Enabled (I) and press the Front Panel rotary knob to select. The Translator slider will turn green when enabled. Pressing the Back button will exit the Translator menu.

Use the Front Panel rotary knob to edit the FSK parameters and press the Front Panel rotary knob to select.

This menu has five (5) sub-menu options:

- FSK ID Enable - enables (ON) or disables (OFF) the station ID feature.
- FSK Call Sign - sets the station's call sign letters.
- FSK Deviation Polarity - sets the polarity of the carrier shift. Select either Positive or Negative.
- FSK Deviation Frequency - sets the amount of carrier shift from the original carrier frequency. Select a value between 5 kHz and 25 kHz.
- FSK Repeat Interval - determines how often the call sign is broadcast using FSK (recommended at least once per hour). Select a value between 1 and 60 minutes.

Figure 2.2.105: Translator

Signal Generator

To enable the test signal generator output, (see [Figure 2.2.106 on page 2.2.128](#)), select Signal Generator from the Settings -> Transmitter menu. Use the Front Panel rotary knob to select the type of waveform desired and press Save. Press Cancel to discard the changes and return to the previous menu.

The Signal Generator options are:

- None
- Sine Wave
- Sine Sweep
- Band-Ltd Noise

Use the Front Panel rotary knob to edit the desired waveform parameters, press the Front Panel rotary knob to enter changes and press the Back button to discard the change and return to the previous menu. See [Figure 2.2.107 on page 2.2.128](#), [Figure 2.2.108 on page 2.2.128](#) and [Figure 2.2.109 on page 2.2.129](#).

Figure 2.2.106: Signal Generator Main Menu

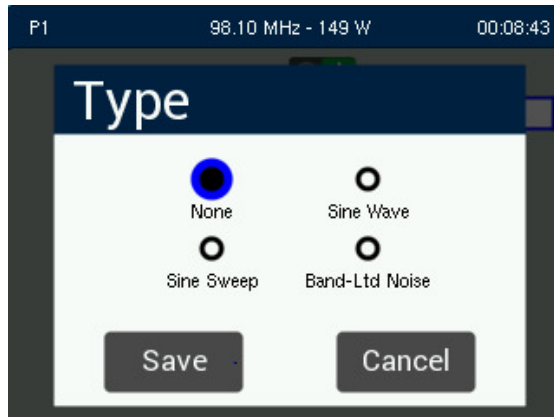

Figure 2.2.107: Signal Generator - Sine Wave



Figure 2.2.108: Signal Generator - Sine Sweep

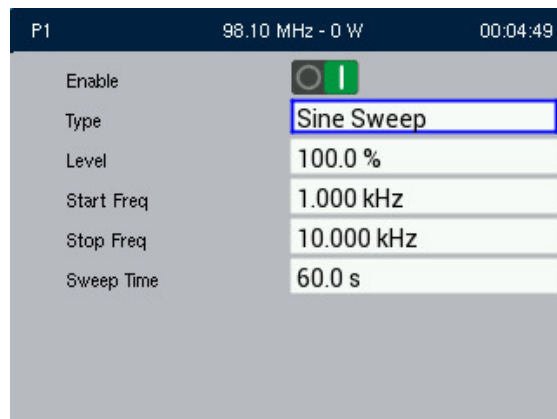
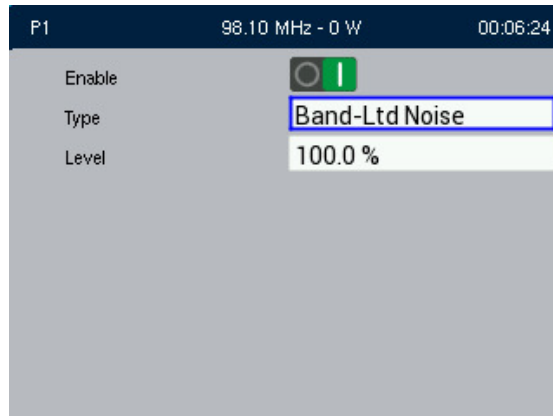

Figure 2.2.109: Signal Generator - Band Limited Noise



Forward Low

To set the Forward Low Thresholds, (see [Figure 2.2.110](#)), select Forward Low from the Settings -> Transmitter menu. There are two thresholds available - Low Power and Very Low Power. The thresholds are based on a percentage of the preset power setpoint. The Forward Low and Forward Very Low alarms will be triggered when the transmitters measured forward power is below the threshold displayed here. Use the Front Panel rotary knob to select the threshold desired and press Save. Press Cancel to discard the changes and return to the previous menu.

Figure 2.2.110: Forward Low

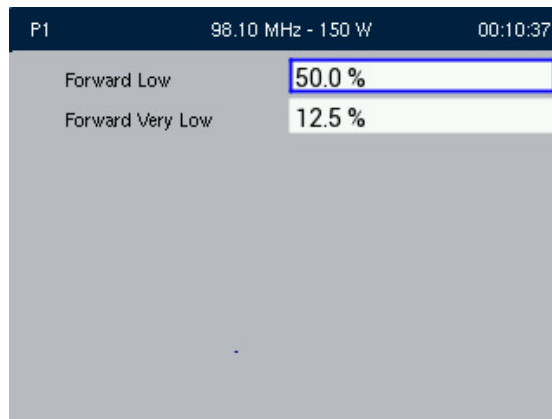

Exciter VCXO

To view the front panel’s VCXO Calibration screens, select Exciter VCXO from the Settings -> Transmitter menu. See [Figure 2.2.111](#).

The 10 MHz Delta and VCXO 10 MHz Calibration values are for display only and are not user adjustable.

NOTE: An external 10 MHz source must be connected to the transmitter and External 10 MHz disabled (refer to [Figure 2.2.104](#) on page 2.2.126 and [Ext 10 MHz Input](#) on page 2.2.139) before attempting to run the calibration routine.

From the Exciter VCXO screen, use the Front Panel rotary knob to select Run VCXO 10 MHz Calibration. The calibration routine will begin when the external 10 MHz source is connected.

Figure 2.2.111: Exciter VCXO

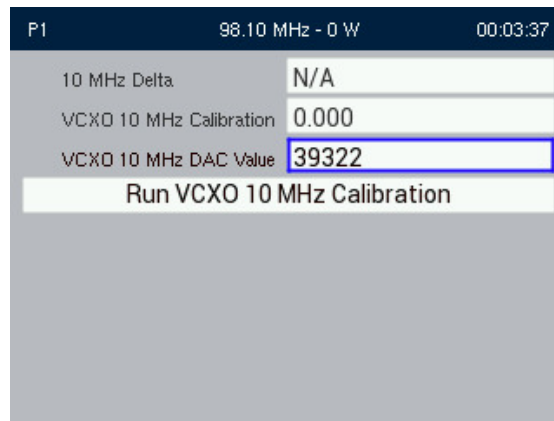

Remote I/O

NOTE: The Exciter PWB (A1) contains a jumper (E1) that allows the user to configure the Remote I/O supply voltage. The factory setting is pins 2 and 3 for internal supply (+12V-OP). To use an external supply voltage for remote inputs, jumper (E1) must be moved to pins 1 and 2 (+12V).

To view the Remote I/O screen (see [Figure 2.2.112](#) on page 2.2.131) on the front panel display, select Settings -> Transmitter-> Remote I/O from the Main Menu. Use the Front Panel rotary knob to select Remote Inputs (see [Remote Inputs](#) on page 2.2.131), Remote Outputs (see [Remote Outputs](#) on page 2.2.132) or Analog Outputs (see [Analog Outputs](#) on page 2.2.132) to view or edit details on the selected inputs or output.

Figure 2.2.112: Remote I/O Main Menu

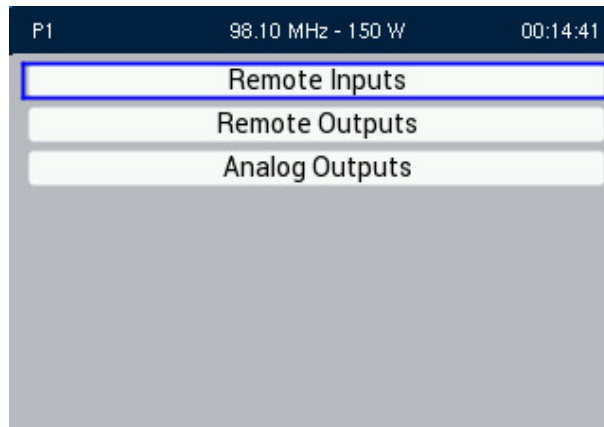

Remote Inputs. When you select Remote Inputs from the Remote I/O screen, you can edit parameters related to a Remote Input. See [Figure 2.2.113](#)).

Nautel sets seven remote input defaults before shipping. See the VX150 to VX2 Installation Manual for details.

Use the Front Panel rotary knob to select the desired remote input (1 through 7) from the list. Each screen shows the current remote input parameter source (e.g., RF On/Off), Trigger (e.g., Falling Edge, Activate) and State (e.g., On/Off) of the corresponding input pin. Use the Front Panel rotary knob to enter the Trigger and/or State for the selected input. Press the Back button to discard any changes.

See the remote AUI section, [Remote I/O, on page 2.2.71](#), for a detailed description of the parameter setting options.

Figure 2.2.113: Remote Inputs

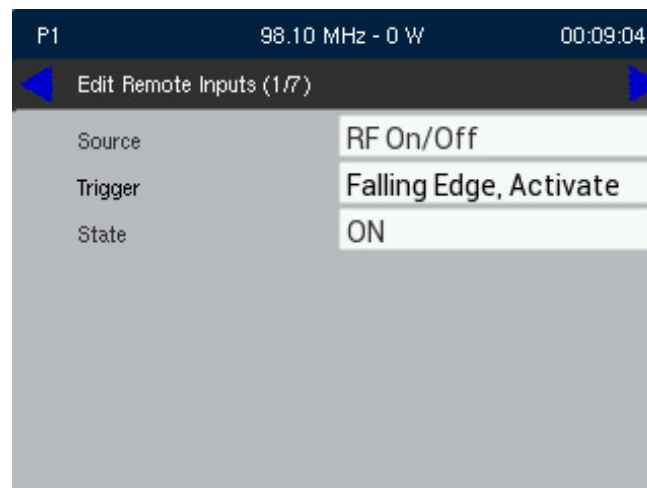

Remote Outputs. When you select Remote Inputs from the Remote I/O screen, you can edit parameters related to a Remote Output. See [Figure 2.2.114](#)).

Nautel sets six (6) remote output defaults before shipping. See the VX150 to VX2 Installation Manual for details.

Use the Front Panel rotary knob to select the desired remote output (1 through 6) from the list. Each screen shows the current remote output parameter (e.g., RF On/Off), as well as the trigger (e.g., Active High) and current state (e.g., on/off) of the corresponding output pin. Use the Front Panel rotary knob to enter the Trigger and/or State for the selected output. Press the Back button to discard any changes.

See the remote AUI section, [Remote I/O, on page 2.2.71](#), for a detailed description of the parameter setting options.

Figure 2.2.114: Remote Outputs



Analog Outputs. When you select Analog Outputs from the Remote I/O screen, you can view and configure the forward and reflected power samples of the transmitter. See [Figure 2.2.115 on page 2.2.133](#)).

Nautel sets the analog Sample Full Scale setting defaults at 5.0 V prior to shipping, with a range of 1.0 to 10.0 V. Use the Front Panel rotary knob to edit the Sample Full Scale setting. Each screen shows the analog output parameter, Forward Power or Reflected Power, as well as the meter reading (actual and full-scale) and the sample voltages (actual and full-scale). Press the Back button to return to the previous menu. See the VX150 to VX2 Installation Manual for details.

See the remote AUI section, [Remote I/O, on page 2.2.71](#), for more information on setting the Sample Full Scale value.

Figure 2.2.115: Analog Outputs

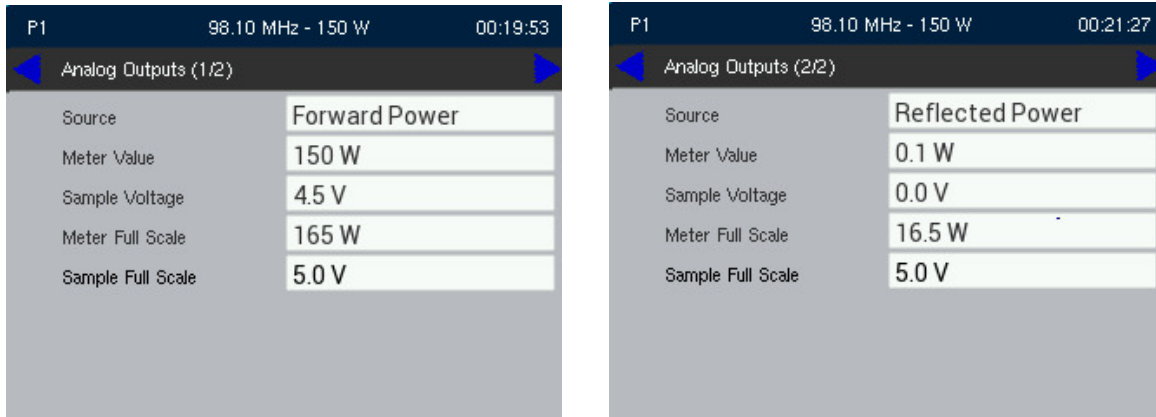

Calibration Menu

WARNING!
 CALIBRATION SETTINGS ARE ESTABLISHED AT NAUTEL AND SHOULD NOT REQUIRE ANY ADJUSTMENT. CONTACT NAUTEL BEFORE MAKING CHANGES.

Allows the user to calibrate various parameters, such as audio inputs and power levels. Select Calibration from the Settings Menu (see [Figure 2.2.116](#)).

Figure 2.2.116: Calibration Menu

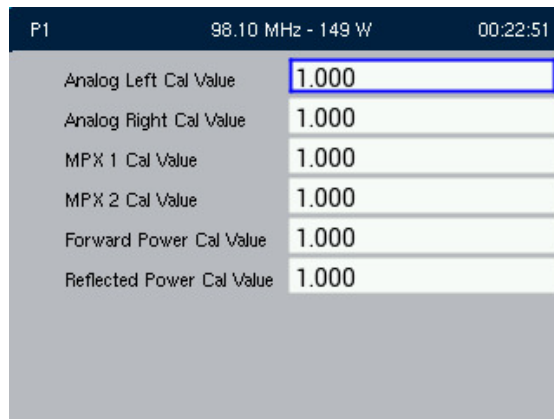

Use the Front Panel rotary knob to select the desired setting and press the knob to make changes. With the appropriate calibrated source applied, use the Front Panel rotary knob to set the new calibration value for the selected input. Press the Back button to discard any changes.

Thresholds Menu

The VX transmitter has two user configurable protection thresholds: SWR Shutdown and SWR Foldback. Adjusting these thresholds increases the transmitter's protection sensitivity to high reflected power. See [Figure 2.2.117](#).

NOTE: Changing these thresholds will alter the transmitter's protection system. Decreasing these thresholds will cause premature transmitter foldback or shutdown conditions, resulting from the lower SWR setting.

The SWR Shutdown threshold has a factory default setting of 3.0, with an adjustable range of 1.1 to 3.0. If the measured SWR exceeds the programmed threshold, the transmitter will shut down and require all SWR related alarms to be cleared prior to enabling RF.

The SWR Foldback threshold has a factory default setting of 1.5, with an adjustable range of 1.1 to 1.5. If the measured SWR exceeds the programmed threshold, but is less than the SWR Shutdown threshold, the transmitter will reduce the RF power. Once all SWR related alarms are cleared, the transmitter will automatically return to the preset power level.

Use the Front Panel rotary knob to edit the desired threshold's SWR setting. Press the Front Panel rotary knob to save the change. Press Cancel button to discard any changes and return to the previous menu.

Figure 2.2.117: Thresholds Menu



Auto-Bias Routine

To initiate the Auto-Bias Routine, select Auto-Bias Routine from the Settings -> Transmitter menu. See [Figure 2.2.118](#). Use the Front Panel rotary knob to confirm the start of the Auto-Bias Routine. Press Cancel to return to the previous menu. You must run the Auto-Bias Routine immediately after one of the following events:

- installation of a new Power Amplifier (PA)
- installation of a new Intermediate Power Amplifier (IPA)
- installation of a new System Interface PWB
- loss of configuration due to SD card or Exciter PWB replacement

NOTE: The Auto-Bias Routine can take up to three (3) minutes to complete.

NOTE: Make sure that the RF stage is disabled (RF off) and the interlock circuit is closed before running the Auto-Bias Routine. If not, a message will appear prompting you to do so. See [Figure 2.2.119](#).

NOTE: The Auto-Bias routine will need to be run if a “Need to run Auto-Bias Routine” alarm appears on the FPUI or AUI.

Figure 2.2.118: Auto-Bias Routine

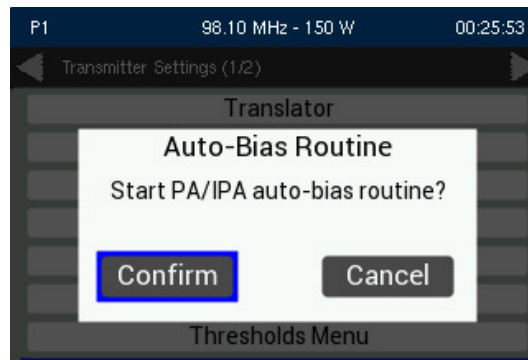
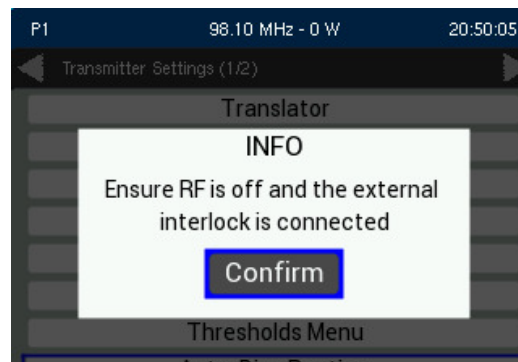

Figure 2.2.119: Auto-Bias Routine Warning Alarm



Turn-on Delay

Allows the user to delay the start-up (RF on) of the transmitter when recovering from an Ac power loss, in order to limit the simultaneous power demand for multiple transmitters on a common generator by staggering their turn on sequence. See [Figure 2.2.120](#). Allowable range is 0-120 seconds, default is 0 seconds (disabled).

Figure 2.2.120: Turn-on Delay

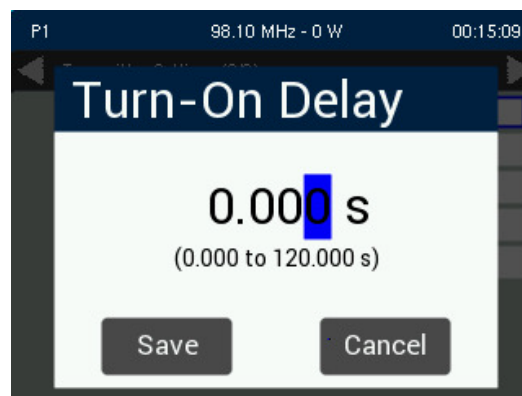

Ramp-up Speed

Allows the user to alter the transmitter's start-up speed of the transmitter when recovering from an Ac power loss. This setting establishes the time it takes the transmitter to ramp up from 0 W to full power. This setting directly increases the system's speed to reach full power. Normally the transmitter will take about 7 seconds to reach full power. For example if the desired ramp up time is 30 seconds, then the ramp-up setting should be set to 23 seconds. In multi-transmitter systems that are on a common generator or power grid, adjusting the ramp-up speed can be used to reduce the transient load on the source during an ac power recovery. See [Figure 2.2.121](#).

Use the Front Panel rotary knob to edit the Ramp-Up Speed between 0 (default) and 600 seconds. Press the Front Panel rotary knob to save the change. Press Cancel button to discard any changes and return to the previous menu.

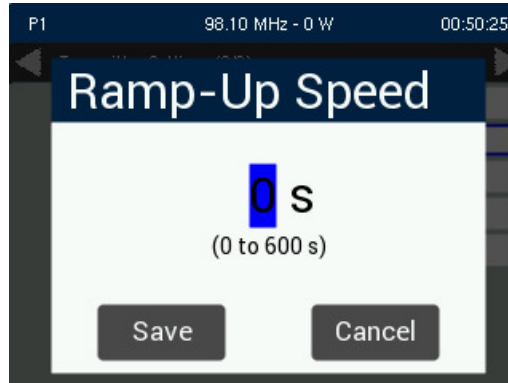
Figure 2.2.121: Ramp-up Speed

Pilot Sample

NOTE: Setting the pilot sample is only available using the front panel UI.

From the front panel UI, you can set the level of the sine-wave pilot sample that is applied to the 19 kHz Out BNC connector on the rear of the transmitter. To view the Pilot Sample screen, select Settings -> Transmitter -> Pilot Sample. See [Figure 2.2.122](#)).

Use the Front Panel rotary knob to edit the pilot sample level between 0 and 2.70 V peak-to-peak (in 0.1 V increments). Press the Front Panel rotary knob to save the change. Press Cancel button to discard any changes and return to the previous menu.

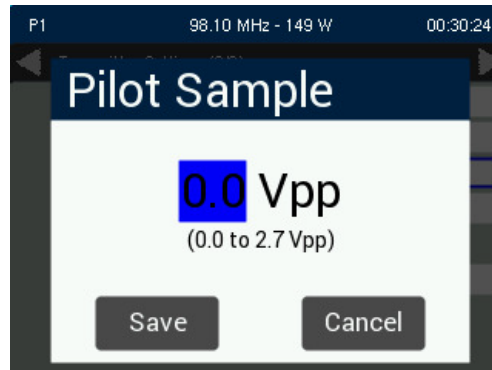
Figure 2.2.122: Pilot Sample

FM Mask

Allow the user to select the appropriate FM mask standard (FCC, ETSI or None) being used by the analyzer on the Remote AUI. The selection affects the mask lines on the Remote AUI's Spectrum Analyzer instrument panel. The factory setting is set for FCC. See [Figure 2.2.123](#)).

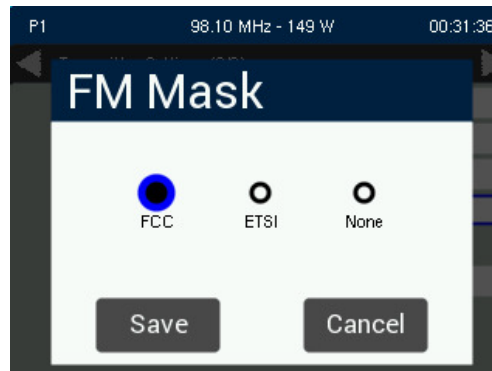
Figure 2.2.123: FM Mask

Use the Front Panel rotary knob to change the FM Mask setting. Press the Front Panel rotary knob to save the change. Press Cancel button to discard any changes and return to the previous menu.

FM Polarity

Allows the user to invert the polarity of the frequency modulation (ie. positive going modulation signal yields positive deviation; or positive going modulation yields negative deviation). Options are Normal (default) or Inverted. Use the Front Panel rotary knob to select Normal or Inverted and press the Front Panel rotary knob to select. Press the Cancel button to return to discard any changes. See [Figure 2.2.124](#).

NOTE: Make sure that the RF stage is disabled (RF off) before changing the FM Polarity setting. If not, a message will appear prompting you to do so.

Figure 2.2.124: FM Polarity

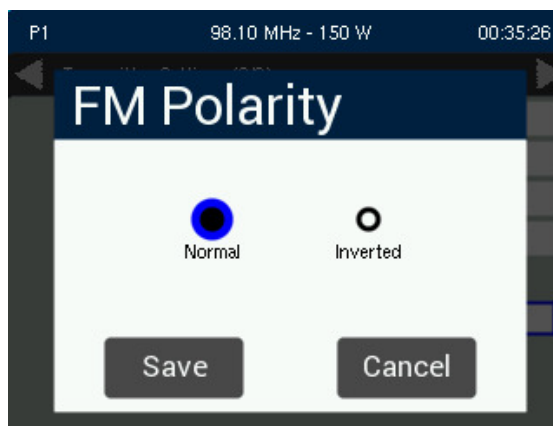

Ext 10 MHz Input

Allows the user to enable/disable the External 10 MHz input. See [Figure 2.2.125](#)). Use the Front Panel rotary knob to edit the slider setting to Enabled (I) and press the Front Panel rotary knob to select. The Ext 10 MHz Input slider will turn green when enabled. Press the Back button to return to the previous menu.

Figure 2.2.125: Ext 10 MHz Input

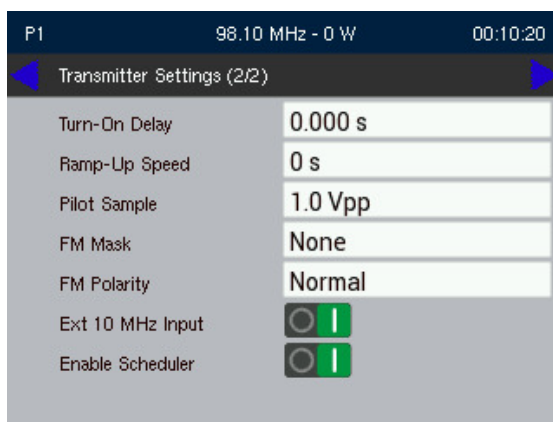

Enable Scheduler

If the scheduler is enabled, you can program a preset schedule for the transmitter. Select Preset Scheduler from the Settings page in the Dashboard menu (see [Figure 2.2.126](#)) to set the dates and times at which presets take effect. You can define up to 62 different schedule rules.

NOTE: Setting the Scheduler Rules can only be edited using the Remote AUI.

Use the Front Panel rotary knob to edit the slider setting to Enabled (I) and press the Front Panel rotary knob to select. Press the Back button to return to the previous menu.

Figure 2.2.126: Enable Scheduler

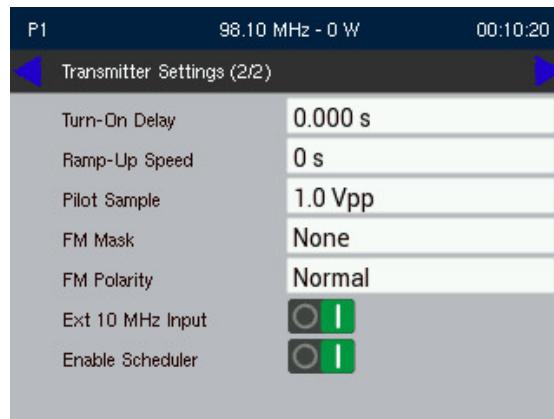

Software

The Software menu is divided into four sub-menus (see [Figure 2.2.127](#)):

- Reboot Exciter/Controller
- Software Upgrade (see [page 2.2.142](#))
- Firmware Revision (see [page 2.2.142](#))
- Unique Hardware ID (see [page 2.2.143](#))
- Nameplate License (see [page 2.2.144](#))

Figure 2.2.127: Main Software Menu

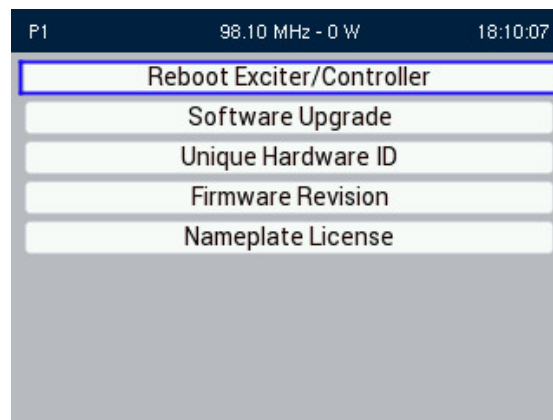

Reboot Exciter/Controller

To perform an Exciter/Controller reboot, use the Front Panel rotary knob to select Confirm and press the Front Panel rotary knob to select. Press Cancel to return to the previous menu. See [Figure 2.2.128](#).

Rebooting the Exciter/Controller is synonymous with an ac cycle, where the state of the transmitter prior to the reboot will remain intact. All presets, user configured settings, etc. are saved and the transmitter returns to the operation prior to the reboot.

Figure 2.2.128: Reboot Exciter/Controller

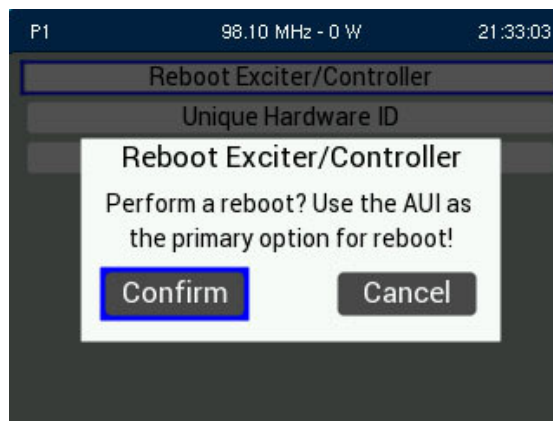

Software Upgrade

Periodically, enhancements or improvements to the operating system are identified and made available. The Software Upgrade screen allows the user to upgrade the VX Operating system.

For detailed information on performing a software upgrade, refer to [Software Upgrade via FPUi on page 2.4.3](#).

Firmware Revision

The Firmware Revision screen displays the current versions of the different firmware being used in the transmitter. See [Figure 2.2.129 on page 2.2.143](#).

Figure 2.2.129: Firmware Revision

P1		98.10 MHz - 0 W	00:21:42
DSP Firmware Revision	0.0.3.170		
FPGA Firmware Revision	1.0.200		
SIB Firmware Revision	0.0.0.92		
Orban Firmware Revision	1.0.0.37		

Unique Hardware ID

The Unique Hardware ID screen displays the Hardware ID used by the transmitter. See [Figure 2.2.130](#).

Figure 2.2.130: Unique Hardware ID

P1		98.10 MHz - 0 W	14:09:04
Unique Hardware ID	3958303135300B0F000900		

Nameplate License

The Nameplate License screen allow the user to assign a Nautel provided License key to the transmitter in the event the SD card becomes corrupted. See [Figure 2.2.131](#).

Figure 2.2.131: Nameplate License

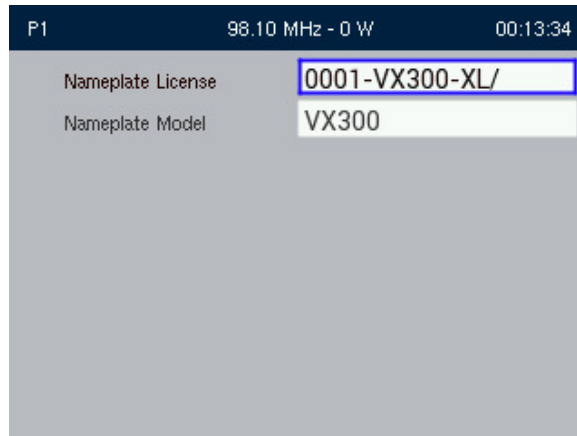

Use the Front Panel rotary knob to select the Nameplate License field and press the knob to enter the editing menu (see [Figure 2.2.132](#)). Press the Back button to abort editing and return to the previous setting.

Figure 2.2.132: Nameplate License - editing screen

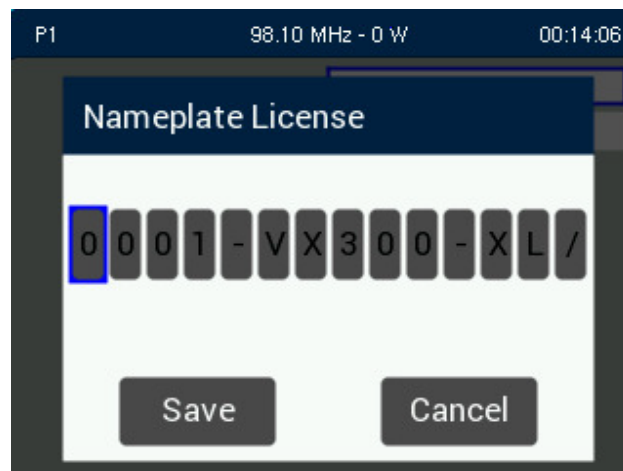

To enter a Nameplate License, use the Front Panel rotary knob to select the characters for the nameplate license name provided. Press the Front Panel rotary knob to save the changes. Press the Cancel button to discard the changes and return to the previous setting.

SECTION 2.3: ROUTINE MAINTENANCE

This section provides instructions for performing routine maintenance on the VX150 to VX2 transmitter. This section includes the following topics:

- [Scheduled Maintenance](#)
 - ❖ [Cleaning](#)
- [Replacing an Air Filter - see page 2.3.2](#)
- [Performing On-Air Checks - see page 2.3.4](#)

Scheduled Maintenance

Scheduled maintenance consists of performing a visual inspection of the VX150 to VX2 at scheduled intervals. The recommended minimum time between scheduled maintenance visits is three months. Local operating and environmental conditions may dictate more frequent visits, while in remote sites less frequent visits may be acceptable. Experience and system reliability will determine the most practical schedule for a specific installation.

Cleaning

At a minimum, follow the cleaning procedures listed below.

NOTE: *A site located in a dirty area using open-air cooling requires more extensive cleaning than a site located in a clean area using closed-air cooling.*

1. Check the air filter, noting it is behind the filter securing panel on the front of the transmitter. Remove the air filter, inspect it, then re-install the air filter if it is clean. If the air filter is dirty wash and dry it and if it damaged, replace it as soon as possible. See [Replacing an Air Filter, on page 2.3.2](#).
2. Clean the VX150 to VX2 using a vacuum cleaner and a soft-bristle brush to remove loose dirt. Never use compressed air to clean the VX150 to VX2.

Replacing an Air Filter

The transmitter contains one air filter in the front of the transmitter (see [Figure 2.3.1 on page 2.3.3](#)). If an air filter is damaged, replace it as follows:

Interval

As required.

Parts and tools

- Replacement air filter

Procedure

Take the following steps to replace an VX150 to VX2 air filter:

1. Order a new filter, as necessary. You can order from Nautel (Nautel Part # HAM95) or obtain one from any local supplier of HVAC supplies.
2. Unpack the new filter and inspect it for damage.
3. Remove and retain the four M3 Phillips screws securing the fan cover from the front of the transmitter and remove the filter.
4. Insert the new air filter and reinstall the fan cover using the screws retained in [Step 3](#).
5. Dispose of the dirty or damaged air filter.

Figure 2.3.1: Replacing Air Filter

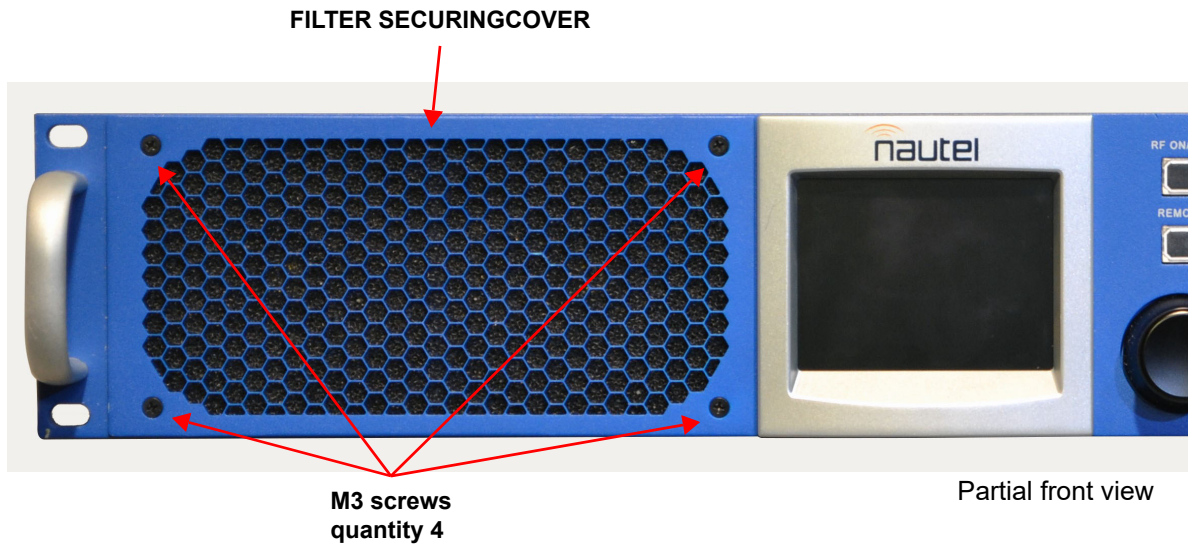

Performing On-Air Checks

You should check the on-air quality of the transmitter's signal periodically. This check can be done locally at the transmitter site, or remotely from another location in the transmitter's coverage area.

Interval

Every 12 months, or as required by law.

Parts and Tools

- High-quality receiver compatible with the modulation scheme used on the transmitter.

Procedure

1. Monitor the transmitter signal to identify any problems:
 - ❖ Use a high quality receiver to monitor audio quality.
 - ❖ Check the spectral output of the transmitter. You can use the remote AUI's spectrum analyzer as a basic indication of the transmitter's spectral output but always use a calibrated measurement instrument when making measurements for regulatory compliance.
 - ❖ Take a portable receiver to different locations in your coverage areas to identify any problems with the antenna pattern or areas of localized interference.
2. Obtain the Critical Parameters sheet that was completed during factory testing and provided with the transmitter. Use the transmitter's AUI to compare current transmitter settings with those on the Critical Parameters sheet.

NOTE: *Nautel completes the Critical Parameters sheet with the transmitter terminated into a precision 50 ohm load. Measurements made on site into a dummy load or station antenna may not yield the same readings. Slight variances are acceptable. The data is provided as a troubleshooting aid.*

SECTION 2.4: NON-STANDARD MAINTENANCE

This section provides instructions for performing non-standard maintenance on the VX150 to VX2 transmitter. This section includes the following topics:

- [Cloning the SD Card](#)
- [SD Card Replacement on page 2.4.2](#)
- [Upgrading Software on page 2.4.3](#)

NOTE: *Nautel recommends you make a copy/clone of the original SD card that was shipped with the transmitter. The SD card contains a license file that linked to a unique ID on the System Interface PWB. Use a Class 10 SD card with a minimum 8 GB capacity (e.g., Nautel part number UB114, vendor part number Cactus KS8GR-245, or equivalent).*

Cloning the SD Card

The VX transmitter's OS (operating system) is stored on an external SD card. It contains the OS, preset information and the transmitter calibration data. It is recommended to have a back-up SD card in the event of a failure. To make a copy of the SD card, perform the following steps:

- Disconnect the ac power from the transmitter.
- Remove the original SD card shipped with the transmitter from the slot in the rear panel of the VX transmitter.
- Insert the SD card into a card reader connected to a laptop or PC or an external SD cloning device.
- Insert the new blank SD card [Nautel part # UB114 or equivalent (8 GB)] into a second reader/slot.



Note:

If you do not have a secondary card reader, your cloning utility may be able to save an image of the original SD card and then burn the saved image to the new SD card.

- Use a drive cloning utility to clone the source card (from the transmitter) to the destination card (new blank card).
- Remove the original SD card and re-install it in the transmitter.
- Remove the new cloned SD card and store it in a safe location, such as the Ancillary Kit.

SD Card Replacement

**Note:**

The SD card contains a license file that is linked to a unique ID on the System Interface PWB, which identifies the power level of the transmitter. If the System Interface PWB is replaced, a new license key needs to be added to match the new PWB.

Should the SD card become damaged or corrupt, replace the SD card as follows:

- Disconnect the ac power from the transmitter.
- Remove the damaged or corrupted SD card from the slot in the rear panel of the VX transmitter.
- Obtain a cloned copy of the original SD card shipped with the transmitter. Refer to [Cloning the SD Card on page 2.4.1](#) or contact Nautel.
- Install the new SD card and reconnect the ac power to the transmitter. The transmitter should be ready to return to proper operation.

Upgrading Software

Periodically, enhancements or improvements to the operating system are identified and made available. Perform a software upgrade using either of the User Interfaces:

- [Software Upgrade via FPUI on page 2.4.3](#)
- [Software Upgrade via Remote AUI on page 2.4.5](#)

NOTE:

Nautel recommends you make a backup of the transmitter's SD card. See [Cloning the SD Card](#) - see [page 2.4.1](#).

Nautel recommends you perform a software upgrade at the transmitter site.

For port-forwarded transmitters, uploading of the .tgz file must occur locally or on the transmitter side of the router.

Parts and Tools

- Laptop (i.e., local computer for direct connection) or network computer with Windows and Web browser
- CAT5 Ethernet cable
- Upgrade software (*.tgz file), provided via email or web download

Software Upgrade via FPUI

A copy of the .tgz file must be on a USB drive and plugged into one of the three USB ports on the VX transmitter (front panel or either rear panel ports). Select the desired .tgz file from the list and click Confirm to initiate the upgrade process. See [Figure 2.4.1](#).

Figure 2.4.1: Upgrade File(s)

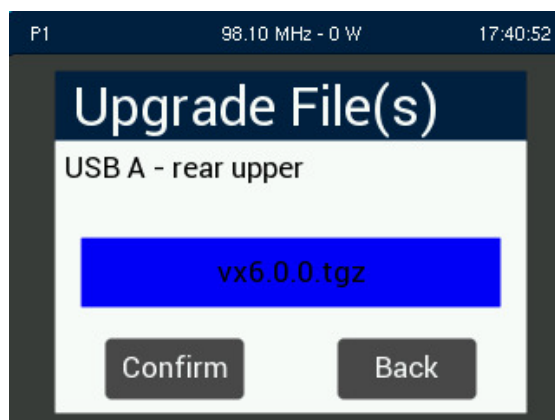

Upper rear panel USB port shown for reference

Once the Upgrade Software procedure has started, a bar graph displays the progress. See [Figure 2.4.2](#).

Figure 2.4.2: Software Upgrade in progress

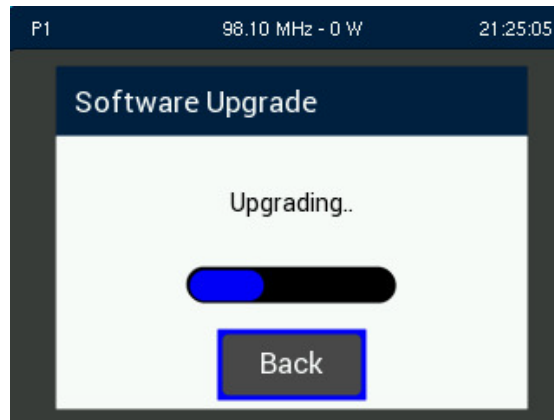

If the software upgrade is successful, a pop-up screen will be displayed, indicating that a system reboot is required for the new software installation to be completed. See [Figure 2.4.3](#).

Figure 2.4.3: Software Upgrade Complete

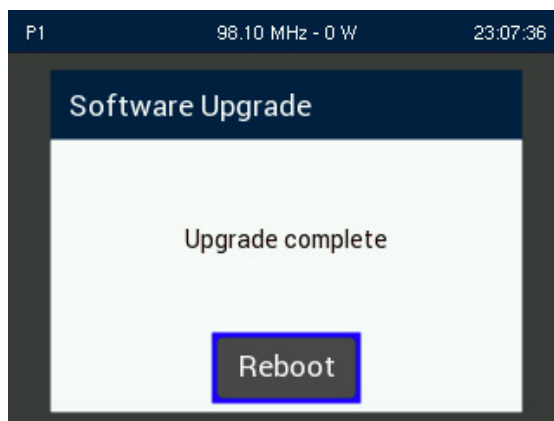

If an error is encountered during the upgrade procedure, a pop-up screen will be displayed indicating that the upgrade was unsuccessful and the Operating System will remain unchanged. Press Confirm to accept the failed upgrade and return the transmitter to the original (prior upgrade) operating system. See [Figure 2.4.4](#) on [page 2.4.5](#).

Figure 2.4.4: Software Upgrade Fail

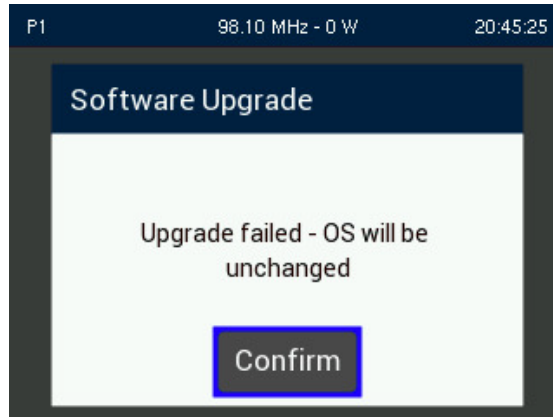

Software Upgrade via Remote AUI

The Upgrades page (see Figure 2.4.5) in the Software menu allows for uploading a suite of software upgrade files (.tgz files) via remote connection. Navigate the page as described below to complete an upgrade.

Figure 2.4.5: Software - Upgrades

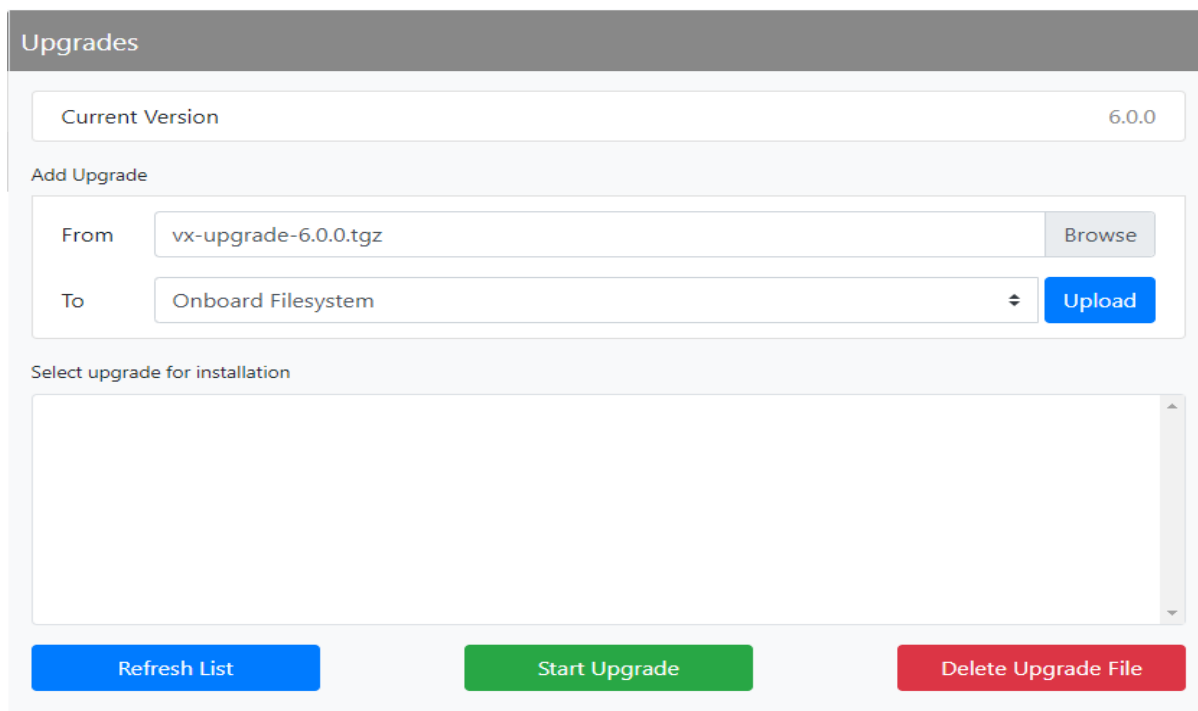

Select Browse to locate a .tgz file to upload to the transmitter and click Upload to save the file in the Select upgrade for installation field. A status bar will be displayed showing the percentage completed. See [Figure 2.4.6](#).

Figure 2.4.6: File Upload in Progress

The screenshot shows a web interface titled "Upgrades". At the top, there is a "Current Version" field with the value "6.0.0". Below this is an "Add Upgrade" section. It contains a "From" field with the text "vx-upgrade-6.0.0.tgz" and a "Browse" button. The "To" field is a dropdown menu currently set to "Onboard Filesystem", with a "Cancel" button to its right. A green progress bar below the "To" field indicates "Uploading 100.00 %". Underneath is a "Select upgrade for installation" section with an empty list box. At the bottom of the interface are three buttons: "Refresh List" (blue), "Start Upgrade" (green), and "Delete Upgrade File" (red).

.tgz file shown for reference, software upgrade file name will differ

When the file is fully uploaded, the file will be displayed in the Select upgrade for installation field. See [Figure 2.4.7](#) on page 2.4.7.

Figure 2.4.7: File Upload field populated

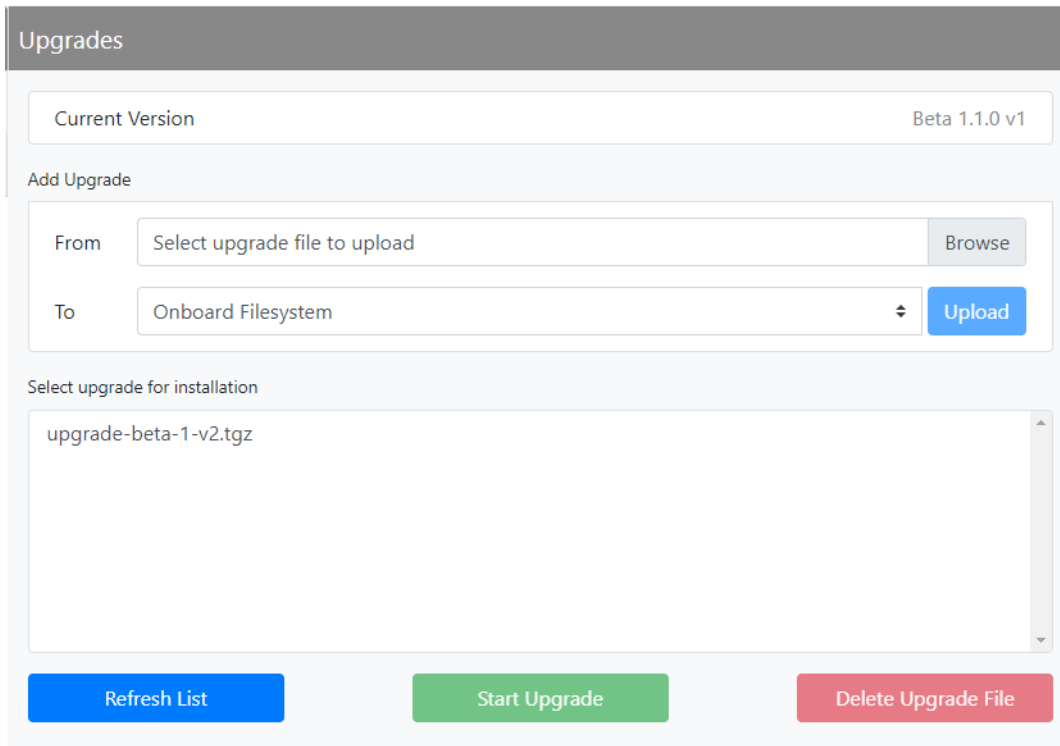

Select the upgrade file from the list and click Start Upgrade to initiate the software upgrade process. A warning will be displayed, indicating that the upgrade can take up to fifteen (15) minutes to complete and cannot be stopped once started. Also, the transmitter can remain in an on-air state during the upgrade. Press Yes to start the upgrade process or Cancel to not proceed with an upgrade. See [Figure 2.4.8](#).

Figure 2.4.8: Upgrade Warning

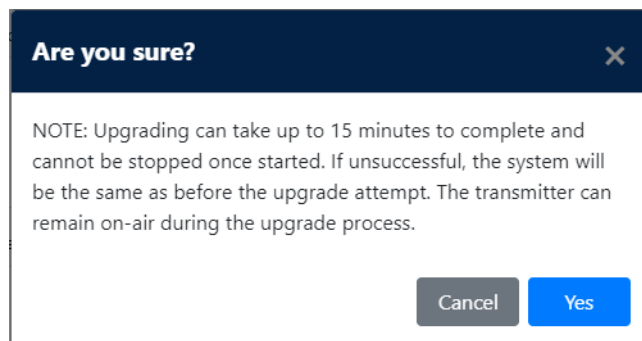

A status bar will be displayed showing the percentage completed. See [Figure 2.4.9 on page 2.4.8](#).

Figure 2.4.9: File Upgrade in progress

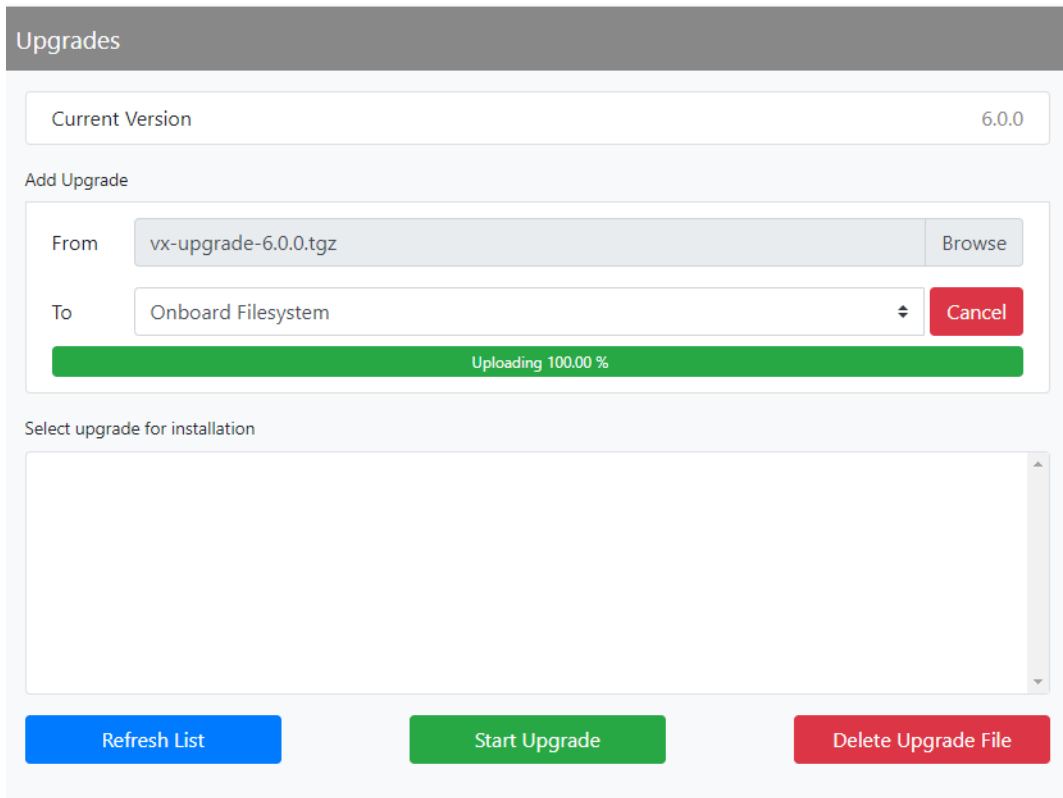

A notification will be displayed if the upgrade was successful or has failed.

If the upgrade was successfully completed, the transmitter will require a reboot. Click the Reboot button or the link in the top banner to start the reboot process. See [Figure 2.4.10](#).

Figure 2.4.10: File Upgrade Complete/Reboot

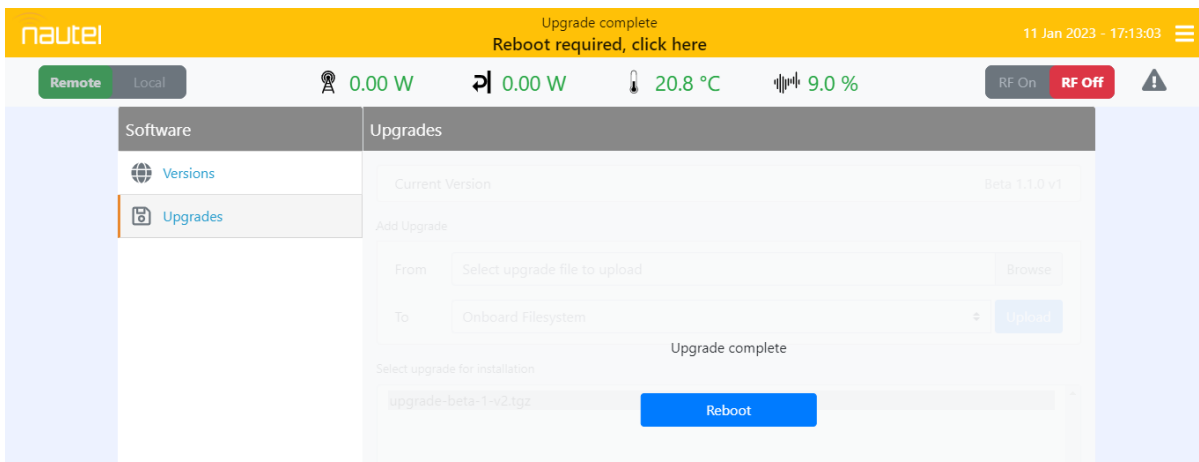

A warning will be displayed, indicating that the transmitter will be off-air for up to two (2) minutes during a reboot. Press Yes to reboot that transmitter or Cancel to revert to the previous software. See [Figure 2.4.11 on page 2.4.9](#).

Figure 2.4.11: Reboot Warning

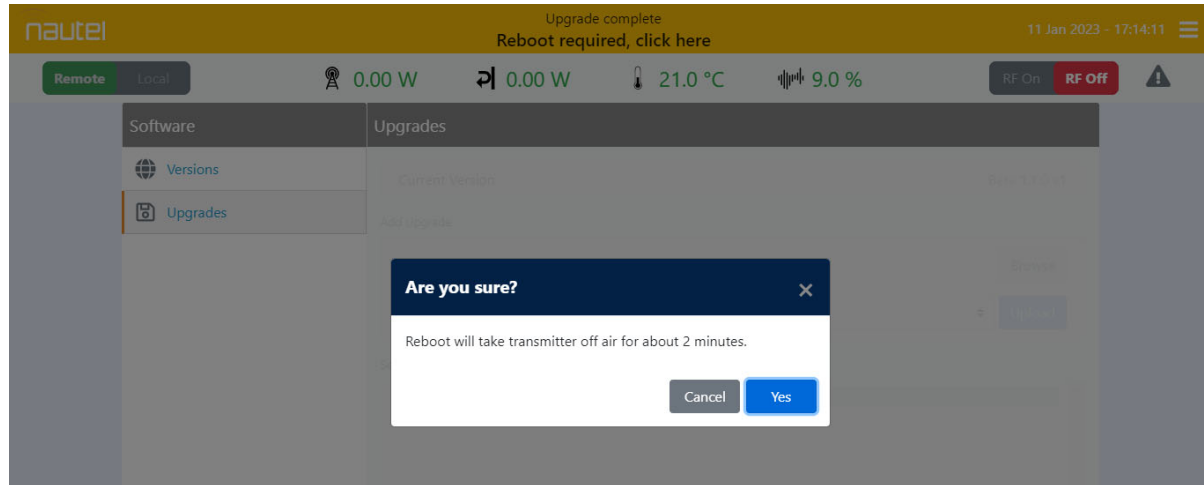

If the upgrade failed, the Operating System will remain unchanged and a pop-up screen will be displayed for the user to acknowledge the failed attempt.

Clicking on Refresh List will show the user all upgrade files currently available. To delete an upgrade file from the list, select the desired file and click Delete Upgrade File. See [Figure 2.4.5 on page 2.4.5](#).

Once rebooted, you will have to log back into the transmitter, using your Username and Password. Refer to [Logging into the AUI - see page 2.2.10](#).

SECTION 2.5: LIST OF TERMS

This section defines some of the terms that are used in Nautel documentation.

AES/EBU. Audio Engineering Society/European Broadcasting Union (AES/EBU) is the name of a digital audio transfer standard. The AES/EBU digital interface is usually implemented using 3-pin XLR connectors (the same type connector used in professional micros). One cable carries both left-channel and right-channel audio data to the receiving device.

CUTBACK. A reduction in RF output power, caused by the occurrence of multiple shutbacks within a pre-defined period.

DHCP. Dynamic Host Carrier Protocol.

DSP. Digital Signal Processing.

EEPROM. Electrically Erasable Programmable Read-Only Memory.

FOLDBACK. A reduction in RF output power, caused by adverse load conditions (high VSWR). No shutbacks or cutbacks have occurred.

FPUI. The Front Panel User Interface is the transmitter's front panel display that allows for extensive local control and monitoring of the transmitter.

LED. Light Emitting Diode (also referred to as lamp).

LVPS. Low Voltage Power Supply. A module or modules used in the ac-dc power stage that generates the low level dc supply voltage for the transmitter.

PRESET. A setting that controls power level, frequency and audio parameters. The VX150 to VX2 allows you to pre-program multiple presets.

PWB. Printed Wiring Board.

REMOTE AUI. The Remote AUI allows for extensive remote control and monitoring of the transmitter.

SHUTBACK. A complete, but temporary loss of RF output power, caused by any one of a variety of faults, including high VSWR.

SHUTDOWN. A complete and permanent loss of RF output power. Typically follows repeated cutback, foldback or shutback events.

SURGE PROTECTION PANEL. An electrical panel that protects equipment from electrical surges in the ac power supply, antenna or site ground caused by lightning strikes.

VSWR. Voltage standing wave ratio. This is an expression of the ratio of reverse voltage to forward voltage on the feedline and antenna system. An ideal VSWR of 1:1 provides maximum transmitter-antenna efficiency.

VX150 TO VX2 OPERATIONS & MAINTENANCE MANUAL

Document: NHB-VX150-VX2-OPS

Issue: 2023-04-20

Nautel Limited

10089 Peggy's Cove Road
Hackett's Cove, NS Canada B3Z 3J4

Toll Free: +1.877.6NAUTEL (662.8835)
(Canada & USA only) or

Phone: +1.902.823.3900 or

Fax: +1.902.823.3183

Nautel Inc.

201 Target Industrial Circle
Bangor, Maine USA 04401

Phone: +1.207.947.8200

Fax: +1.207.947.3693

Customer Service (24-hour support)

+1.877.628.8353 (Canada & USA only)

+1.902.823.5100 (International)

Email: support@nautel.com

Web: www.nautel.com

© Copyright 2022 NAUTEL. All rights reserved.

