



## VS2.5 TRANSMITTER

# OPERATIONS AND MAINTENANCE MANUAL

Document:NHB-VS2.5-OPS

Issue: 12.1 2022-07-22

Status: Standard



**Nautel Limited**

10089 Peggy's Cove Road  
Hackett's Cove, NS Canada B3Z 3J4  
Phone: +1.902.823.3900 or  
Toll Free: +1.877.6NAUTEL (6628835) (Canada & USA only)  
Fax: +1.902.823.3183

**Nautel Inc.**

201 Target Industrial Circle  
Bangor, Maine USA 04401  
Phone: +1.207.947.8200  
Fax: +1.207.947.3693

**Customer Service (24 hour support)**

+1.877.628.8353 (Canada & USA only)  
+1.902.823.5100 (International)

Email: [support@nautel.com](mailto:support@nautel.com)

Web: [www.nautel.com](http://www.nautel.com)

The comparisons and other information provided in this document have been prepared in good faith based on publicly available information. The reader is encouraged to consult the respective manufacturer's most recent published data for verification.

© Copyright 2022 NAUTEL. All rights reserved.





---

# CONTENTS

---

<b>RELEASE CONTROL RECORD</b>	<b>VII</b>
-------------------------------	------------

---

<b>DESCRIPTION</b>	<b>1-1</b>
--------------------	------------

Ac-dc power stage	1-1
-------------------	-----

Exciter/control stage	1-3
-----------------------	-----

RF drive stage	1-4
----------------	-----

RF power stage	1-4
----------------	-----

---

<b>OPERATING THE TRANSMITTER</b>	<b>2-1</b>
----------------------------------	------------

User Interfaces	2-9
-----------------	-----

Viewing Transmitter Log	2-23
-------------------------	------

Viewing AUI Tool Menu Panels	2-30
------------------------------	------

Viewing Real-Time Meters	2-47
--------------------------	------

Managing Presets	2-54
------------------	------

Enabling Remote Control	2-96
-------------------------	------

Resetting Alarms	2-96
------------------	------

Viewing Transmitter Status	2-97
----------------------------	------

System Settings	2-98
-----------------	------

System Settings - Front Panel UI	2-111
----------------------------------	-------

Setting User Accounts	2-123
-----------------------	-------

User Settings - AUI	2-126
---------------------	-------

User Settings - Front Panel UI	2-150
--------------------------------	-------

Configuring Remote Inputs and Outputs	2-162
---------------------------------------	-------

Scheduler	2-176
-----------	-------

Audio Player	2-179
--------------	-------

Enabling and Operating the Orban Audio Processor	2-184
--	-------

---

---

<b>ROUTINE MAINTENANCE</b>	<b>3-1</b>
Scheduled maintenance	3-1
Replacing a damaged air filter	3-2
Performing on-air checks	3-4
Replacing the Exciter/Control PWB battery	3-5

---

<b>NON-STANDARD MAINTENANCE</b>	<b>4-1</b>
Upgrading software	4-1
Configuring an audio loss backup preset	4-5

---

<b>LIST OF TERMS</b>	<b>5-1</b>
----------------------	------------

## RELEASE CONTROL RECORD

Issue	Date	Reason
12.0	2021-11-15	Hardware Release 12 for NARF66J/04 & /05, with UG132 power supplies.  Supports software version VS SW 5.3 and higher.
12.1	2022-07-21	Corrected AUI screens and supporting text in section 4, Non-standard Maintenance



---

## SECTION 1: DESCRIPTION

Refer to the functional block diagram: **Block Diagram - VS2.5 Transmitter** - see [page 1-7](#).

This section provides a high-level description of the transmitter's key sections. The transmitter circuitry is subdivided into four basic stages:

- [Ac-dc power stage](#)
- [Exciter/control stage](#) - see [page 1-3](#)
- [RF drive stage](#) - see [page 1-4](#)
- [RF power stage](#) - see [page 1-4](#)

### VS2.5 ELECTRICAL SCHEMATICS

Some descriptions in this section refer to electrical schematics (SD-#s) . These are located in Section 5 of the *VS2.5 Troubleshooting Manual*.

---

### AC-DC POWER STAGE

See also electrical schematic Figure SD-1.

The ac-dc power stage converts the ac power source to a positive dc voltage (PA volts) for the transmitter's PA PWBs. The transmitter accepts a 1-phase ac input voltage that is between 180 and 264 V ac (208 V ac nominal).

The ac-dc power stage provides +48 V to operate the RF power stage's pre-amp/IPA PWB, as well as the cooling fans and the low level dc voltages (+15 V and +5 V) for the control/monitoring circuitry used throughout the transmitter.

The ac-dc power stage consists of three ac power entrance terminal blocks (TB1, TB2 and TB3), circuit breaker CB1, two power supply modules (U1 and U2), +48 V power supply module U4 and PS distribution PWB A2.

---

## POWER SUPPLY MODULES

See also electrical schematic Figure SD-1. The power supply modules (U1 and U2) convert the ac input voltage to a regulated dc supply (PA volts) for the PA PWBs (A6 through A9) in the RF power stage. Each power supply module is rated for a nominal 2000 W and provides an output voltage between 7 and 53 V (typically 48 V). The module regulates the output voltage based on a *PA Volts Control* input from the exciter/control PWB (A1). The module has a built-in cooling fan, senses excessive temperature conditions, and applies a *PS Temp* alarm signal to the exciter/control PWB. The module also senses out-of-regulation on the ac input and dc output, and applies *PS Ac Fail* and *PS Fail* alarm signals to the exciter/control PWB. All three alarm conditions cause the power supply to shut itself down, thus inhibiting the transmitter's RF output.

### +48 V POWER SUPPLY

See also electrical schematic Figure SD-1. The +48 V power supply module (U4) converts the ac input voltage to a regulated +48 V dc supply for the pre-amp/IPA PWB, cooling fans, and the dc-dc converters on the power supply distribution PWB, which provide +5 V and +15 V to circuitry throughout the transmitter.

### PS DISTRIBUTION PWB

See also electrical schematics Figures SD-1 and SD-3. The PS distribution PWB (A2) interfaces between the dc power supplies (power supply modules and +48 V supply) and the rest of the transmitter. It distributes the power supply module output to the PA PWB, and distributes the +48 V output to the pre-amp/IPA PWB and the cooling fans.

Dc current samples of the PA, pre-amp and IPA power supplies are measured on the PS distribution PWB and provided to the exciter/control PWB over an SPI bus.

Status and alarm outputs from the power supply modules (U1 and U2), consisting of *PS Present*, *PS Ac Fail*, *PS Temp* and *PS Fail*, are applied to the PS distribution PWB and provided to the exciter/control PWB over an SPI bus.

A fan enable circuit on the PS distribution PWB controls the application of +48 V to the cooling fans in the RF power stage. The exciter/control PWB (A1) provides a *Fan Enable* signal that enables or disables the fan voltage when the RF power stage is on or off, respectively.

Dc-dc converters on the PS distribution PWB convert the +48 V provided by the +48 V supply to +5 V and +15 V, which is then distributed to circuitry throughout the transmitter

---

## EXCITER/CONTROL STAGE

See also electrical schematic Figure SD-1 and Audio Path Block Diagram [Figure 1.2 on page 1-8](#). Detailed schematics are not included in the *Troubleshooting Manual*.

The exciter/control stage performs many critical functions for the transmitter. The primary component of this stage is the exciter/control PWB (A1).

The exciter portion of the exciter/control PWB performs the following functions:

- accepts the audio inputs and generates the RF drive signal required to modulate the audio signal at the desired carrier frequency.
- measures the audio input level.
- provides the status of any exciter fault conditions.

The control portion of the exciter/control PWB performs the following functions:

- contains monitoring/protection circuits to prevent transmitter damage under adverse or fault conditions, including high speed SWR protection and interlock/muting.
- monitors the current value of various parameters including cooling fan tachometer outputs, transmitter output forward and reflected power, PA temperature, PA current levels, and PA power supply status signals.
- measures and monitors the output voltage from the power supply modules as well as the low voltage supplies (+15 V and +5 V) and +48 V power supply.
- generates the dc bias signals for the pre-amp, IPA and PA PWBs.
- generates the signals that enable the power supply modules and control its output voltage.
- provides the status of any controller fault conditions.
- an integral DSP performs all audio processing including filtering and FM baseband modulation.
- interfaces with the RF and power supply sections of the transmitter to perform control and monitoring functions.

- provides local and remote interfacing for the transmitter. Local interfacing is performed via the front panel display (U5) - a 4 x 20 character LCD display - and its adjacent keypad. The UI contains a menu-based series of pages that serve specific functions. Similar interfacing, as well as more advanced functionality, is available on a remotely accessed AUI.

Except for the RF drive signal, all signals going between the exciter, RF drive and RF power stages are passed through the interface PWB (A3).

---

## RF DRIVE STAGE

See also electrical schematics Figure SD-2 and SD-4.

The RF drive stage is comprised of exciter circuitry within the exciter/control PWB (A1), the pre-amp/IPA PWB (A5) and the splitter PWB (A4).

The pre-amp/IPA PWB accepts the low level *RF Drive* output from the exciter/control PWB (A1). Its RF output is generated by the *Pre-Amp V* input (set at +48 V) and *IPA V* input (set at +48 V), as well as the *Pre-Amp Bias* output and *IPA Bias* output from the exciter/control PWB (A1). The RF output level is controlled by the RF input level, generated by the exciter/control PWB. The output of the pre-amp/IPA PWB (nominal 18 W) is applied to a directional coupler on the combiner PWB (A10), which monitors this output level. The directional coupler's sample is applied to the combiner interface PWB (A12). The IPA output is then applied to the input of the splitter PWB (A4). The splitter PWB splits the RF drive signal into four outputs, which are applied to the RF power stage's PA PWBs (A6 through A9). Cooling air for the pre-amp PWB is provided by fan B3.

---

## RF POWER STAGE

See also electrical schematics Figure SD-2 and SD-5.

The RF power stage accepts the intermediate RF drive signal from the RF drive stage and generates the final RF output. It consists of four PA (power amplifier) PWBs (A6 through A9), the combiner PWB (A10), the low pass filter PWB (A11), and the combiner interface PWB (A12).



---

## PA PWB

See Figure SD-5. Each PA PWB (A6 through A9) is a push-pull RF power amplifier. It is capable of providing 850 W of RF power in the FM broadcast band (87.5 to 108.0 MHz). The RF output is controlled by the *PA V* level generated by the power supply module, and the *PA Bias* output from the exciter/control PWB (A1). The RF output of each PA PWB is applied to an input of the combiner PWB. Cooling air for the PA PWB is provided by fans B3 through cooling fan B7.

## COMBINER PWB

See Figure SD-2. The combiner PWB (A10) accepts the RF outputs of the four PA PWBs and, along with a hybrid coupler, combines them into a single output. This single output is applied to the low pass filter PWB (A11).

The output of the low pass filter PWB (A11) is then applied to the power probe section of the combiner PWB. Here, three directional couplers monitor the RF signal before it is passed to the output connector (J2). Due to each coupler's proximity and orientation to the RF output signal, RF voltages are induced in these directional couplers.

The first coupler provides forward and reflected power signals to the combiner/interface PWB (A12) for signal conditioning purposes.

A second coupler provides an RF Sample output (J4, accessible on the rear panel of the transmitter) for use by an external exciter, if applicable.

A third coupler provides an RF Monitor output (J3, accessible on the rear panel of the transmitter), which is a nominal -42 dBc (2 V rms @ 1250 W). This signal is intended for use with a modulation monitor or spectrum analyzer.

## LOW PASS FILTER PWB

See Figure SD-2. The low pass filter PWB (A11) accepts the output of the combiner PWB and attenuates harmonics before applying a filtered RF signal to the output power probe, located on the combiner PWB.

---

## COMBINER INTERFACE PWB

See Figure SD-2. The combiner interface PWB (A12) accepts the output of the IPA forward power coupler and converts it to a dc voltage that is proportional to the RF level through the probe. This signal is then applied to the exciter/control PWB as the *IPA Fwd Pwr* sample.

Similarly, the combiner interface PWB accepts the outputs of the transmitter's output forward and reflected power couplers and converts them to dc voltages that are proportional to the RF levels measured by the couplers. These signals are then applied to the exciter/control PWB as the *Fwd Pwr* and *Refl'd Pwr* samples.

Figure 1.1: Block Diagram - VS2.5 Transmitter

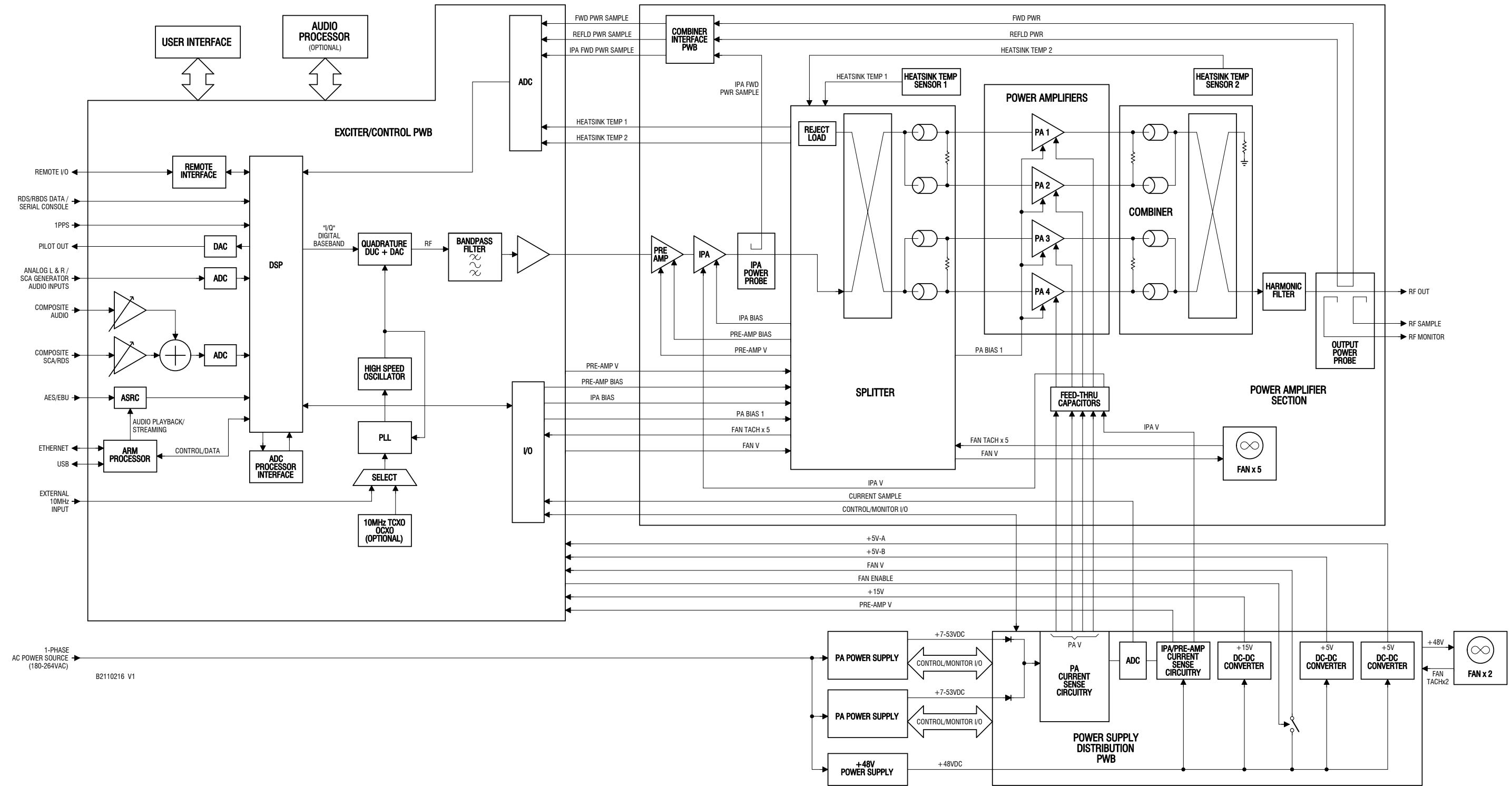
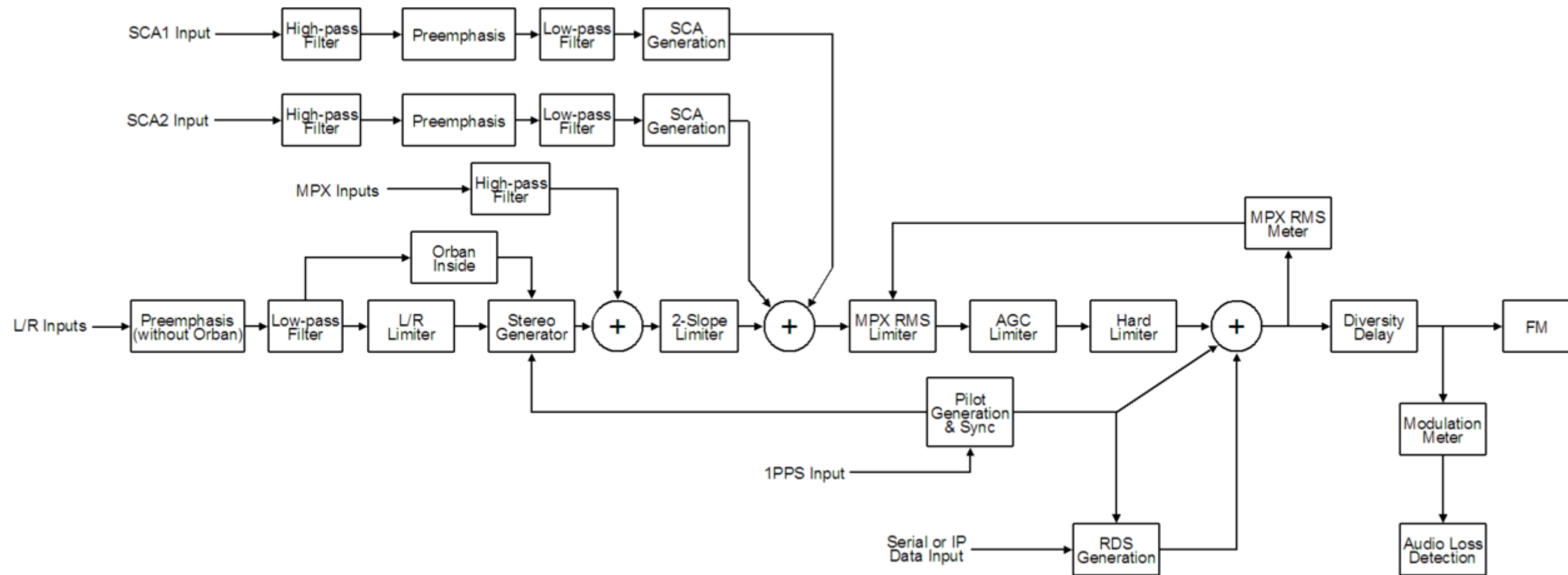


Figure 1.2: Block Diagram - VS2.5 Audio Path



---

## SECTION 2: OPERATING THE TRANSMITTER

This section provides information about operating the VS2.5 transmitter:

- [User Interfaces on page 2-9](#)
  - [Front Panel UI - see page 2-9](#)
  - [Front Panel UI - Main menu - see page 2-10](#)
  - [Front Panel UI Screens - see page 2-12](#)
  - [Advanced User Interface - see page 2-16](#)
  - [Logging into the AUI - see page 2-18](#)
  - [AUI Pages - see page 2-20](#)
  - [AUI Menu page - see page 2-21](#)
- [Viewing Transmitter Log - see page 2-23](#)
  - [Transmitter Log - Using the AUI - see page 2-23](#)
  - [Transmitter Log - Using the front panel - see page 2-28](#)
- [Viewing AUI Tool Menu Panels - see page 2-30](#)
  - [Describing AUI Tool Menu Options - see page 2-31](#)
  - [AUI Tool Menu Panels Procedures - see page 2-33](#)
  - [Available Instrument Panels - see page 2-35](#)
- [Viewing Real-Time Meters - see page 2-47](#)
  - [View Meters - Using the front panel - see page 2-52](#)
- [Managing Presets - see page 2-54](#)
  - [Managing Presets - Using the AUI - see page 2-54](#)
  - [Managing Presets - Using the front panel - see page 2-75](#)
- [Enabling Remote Control - see page 2-96](#)
- [Resetting Alarms - see page 2-96](#)
- [Viewing Transmitter Status - see page 2-97](#)
- [System Settings - see page 2-98](#)
  - [Rebooting the AUI or Exciter - see page 2-100](#)
  - [Upgrading Software - see page 2-101](#)
  - [Calibrating Audio - Using the AUI - see page 2-102](#)
  - [Calibrating Audio Inputs - see page 2-121](#)

- IBOC settings - VSHD only - see page 2-103
- Spectrum/Efficiency Optimizing - Using the AUI - see page 2-104
- Calibrating Exciter TCXO - Using the AUI - see page 2-107
- Setting FM Polarity - Using the AUI - see page 2-109
- Setting FM Polarity - Using the front panel UI - see page 2-110
  
- System Settings - Front Panel UI - see page 2-111
  - Host Reboot - see page 2-112
  - OS Recovery - see page 2-112
  - Configuring Host Watchdog - see page 2-113
  - Firmware Update - see page 2-114
  - LCD Settings - see page 2-114
  - Calibrating Exciter TCXO - Using the front panel UI - see page 2-108
  - HD Optimizing - Using the front panel UI - see page 2-105
  - Configuring Installed Hardware - see page 2-116
  - Adjusting Factory Settings - see page 2-118
  
- Setting User Accounts - see page 2-123
  - Setting User Type - see page 2-124
  - Editing Account Information - see page 2-124
  - First-Time Login - see page 2-125
  
- User Settings - AUI - see page 2-126
  - Email Configuration - see page 2-128
  - Notifications - see page 2-130
  - SNMP configuration - see page 2-134
  - Critical parameters - see page 2-136
  - External 10 MHz Input - Using the AUI - see page 2-137
  - Selecting the FM Mask - Using the AUI - see page 2-139
  - Setting the Clock - Using the AUI - see page 2-141
  - NTP servers - see page 2-144
  - Nautel Phone Home - see page 2-146
  - Setting call sign/ID - see page 2-147
  - Setting Audio Low Thresholds - see page 2-148

- User Settings - Front Panel UI - see page 2-150
  - Setting the Clock - Using the Front Panel - see page 2-143
  - Network Settings - see page 2-151
  - Signal Generator - see page 2-155
  - Setting Station ID parameters - see page 2-157
  - External 10 MHz Input - Using the Front Panel - see page 2-138
  - Selecting the FM Mask - Using the Front Panel - see page 2-140
  - Setting Audio Thresholds - Using the Front Panel - see page 2-149
  - User Settings - Front Panel UI - see page 2-150
  - Turn-On Delay Setting - see page 2-160
  - Ramp-Up Speed Setting - see page 2-161
  
- Configuring Remote Inputs and Outputs - see page 2-162
  - Remote I/O Settings - Using the AUI - see page 2-162
  - Remote I/O Settings - Using the Front Panel UI - see page 2-172
  - Analog Outputs - see page 2-168
  - Site Control Settings - see page 2-169
  
- Scheduler - see page 2-176
  - Enabling the Scheduler - AUI - see page 2-177
  - Enabling the Scheduler - Front Panel - see page 2-178
  
- Audio Player - see page 2-179
  - Playlist - see page 2-180
  - Streams - see page 2-182
  
- Enabling and Operating the Orban Audio Processor - see page 2-184
  - Orban Enabling - Using the Front Panel - see page 2-186
  - Orban Enabling - Using the Remote AUI - see page 2-187
  - Selecting an Orban Preset - Using the Front Panel - see page 2-189
  - Selecting an Orban Preset - Using the Remote AUI - see page 2-189





# FRONT PANEL UI

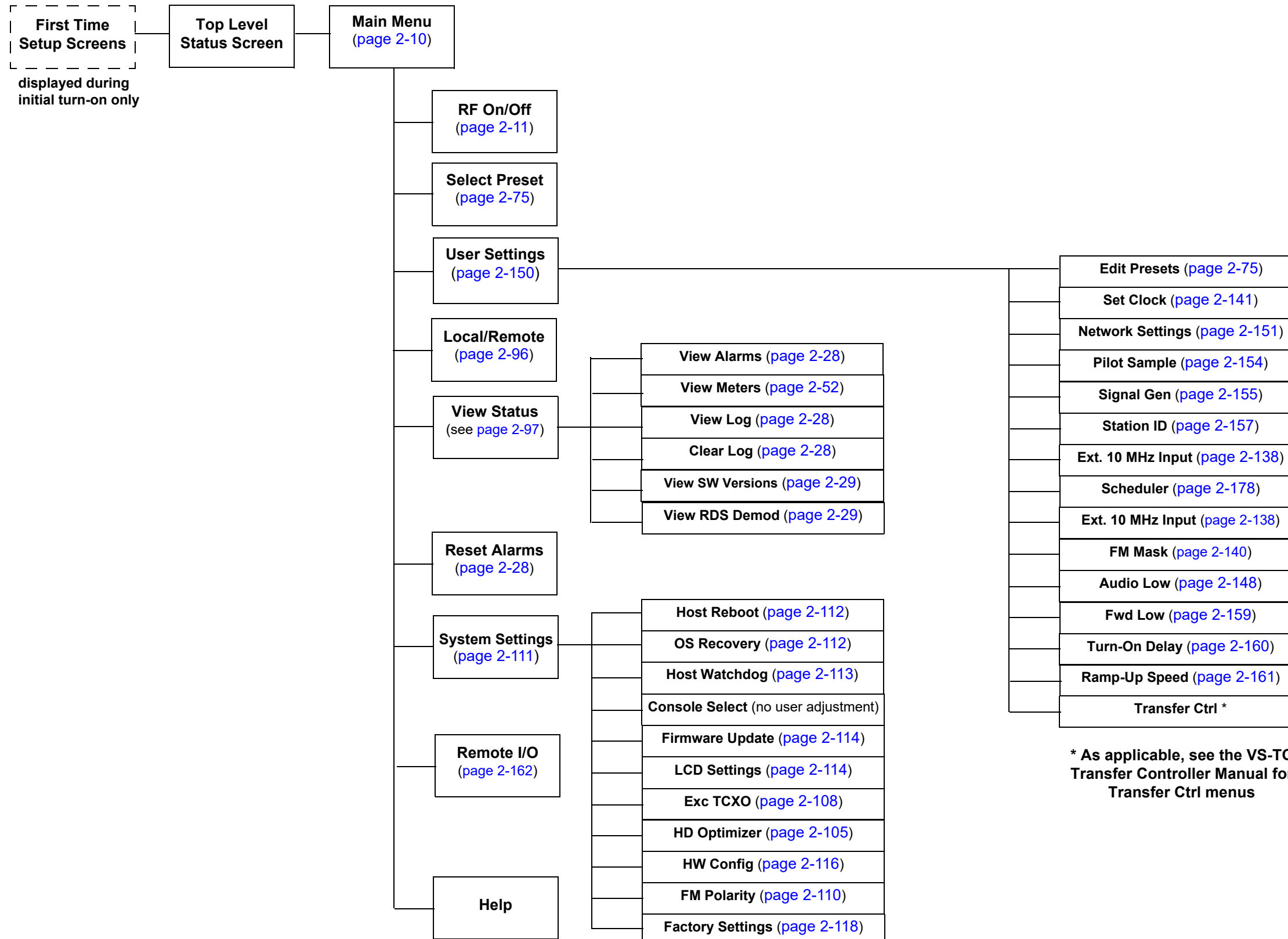


Figure 2-2: VS Transmitter Front Panel Display Menu Tree (Sheet 1 of 2)

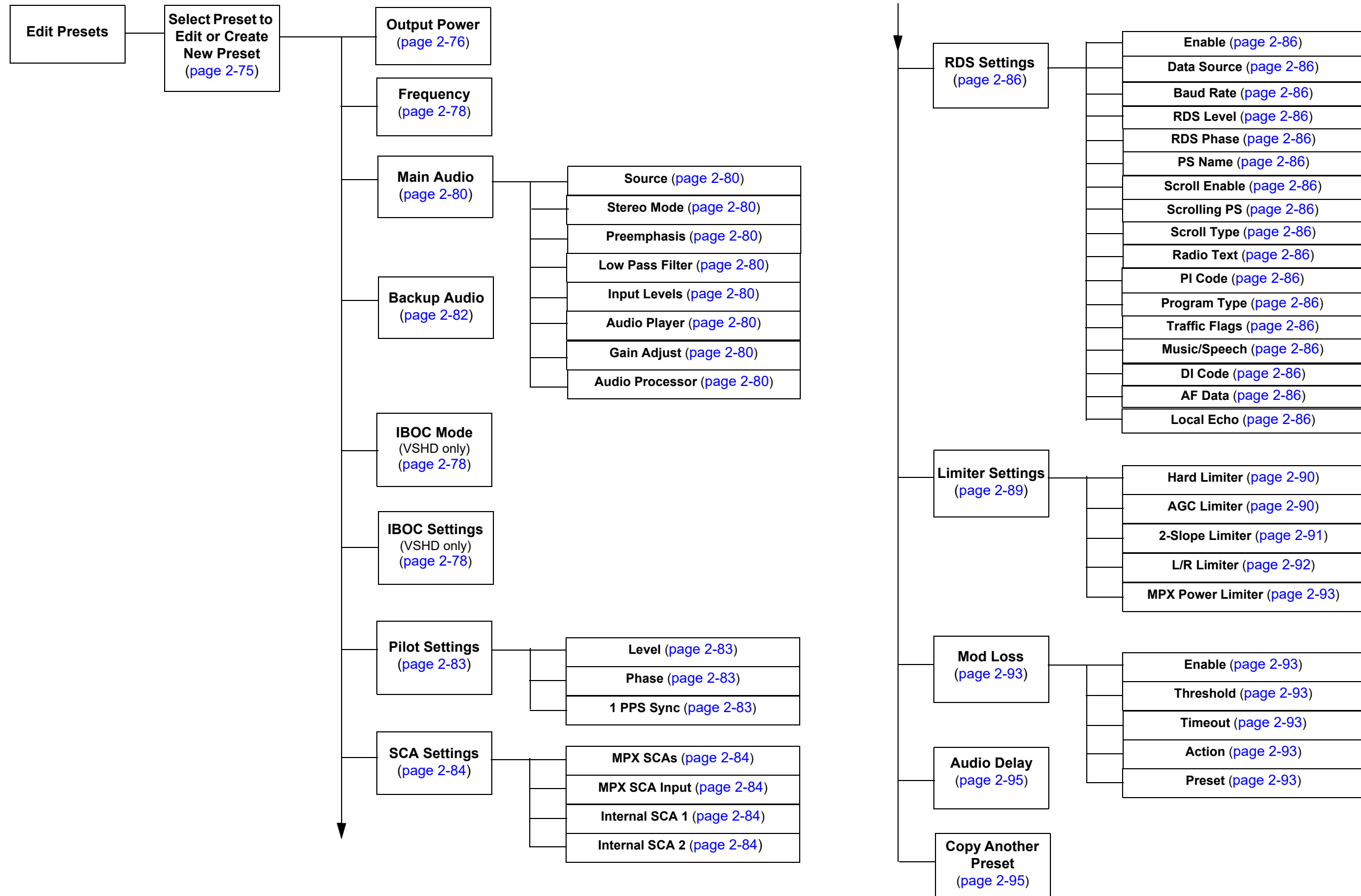


Figure 2-3: VS Transmitter Front Panel Display Menu Tree - Edit Presets (Sheet 2 of 2)

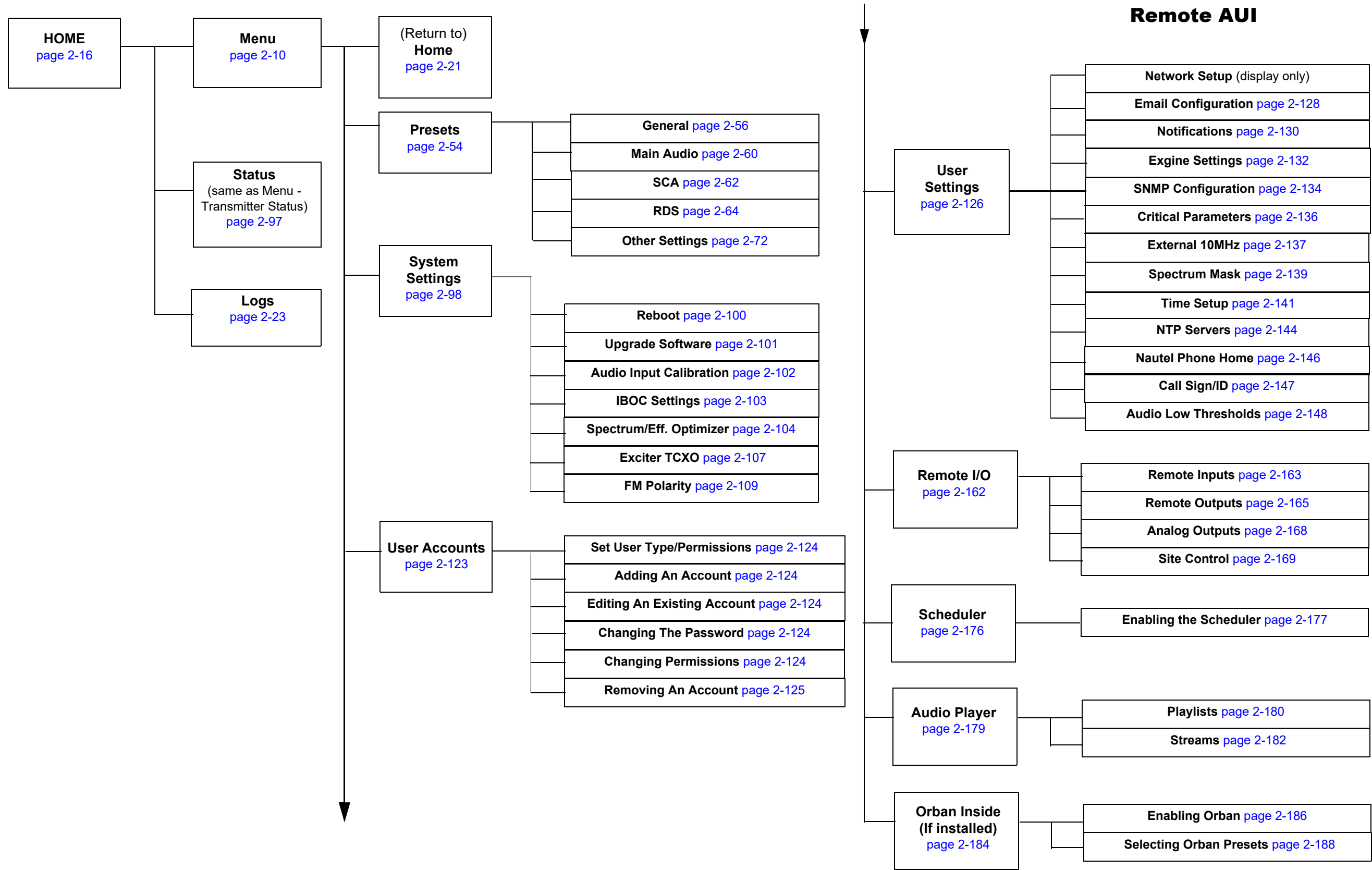


Figure 2-3: VS Transmitter AUI Flow Diagram

## USER INTERFACES

This section includes the following topics:

- [Front Panel UI](#)
- [LCD display - see page 2-10](#)
- [Front Panel UI - Main menu - see page 2-10](#)
- [Navigational buttons - see page 2-11](#)
- [Turning RF on and off - see page 2-11](#)
- [Saving settings - see page 2-11](#)
- [LEDs - see page 2-11](#)
- [Front Panel UI Screens - see page 2-12](#)
- [Advanced User Interface - see page 2-16](#)
- [Logging into the AUI - see page 2-18](#)
- [AUI Pages - see page 2-20](#)
- [AUI Menu page - see page 2-21](#)

The user can interface with the VS2.5 using one of two methods:

- Locally, using the front panel UI and navigational buttons (see [Front Panel UI](#)).
- Remotely, via a LAN connection, using the advanced user interface (AUI) pages (see [Advanced User Interface on page 2-16](#))

See the complete menu hierarchy illustrated in Figures 2.1 and 2.2 (for the local front panel menu) and Figure 2.3 (for the remote AUI menu). When a user interfacing function can be performed from both the front panel display and the remote AUI, both are described in this section.

### FRONT PANEL UI

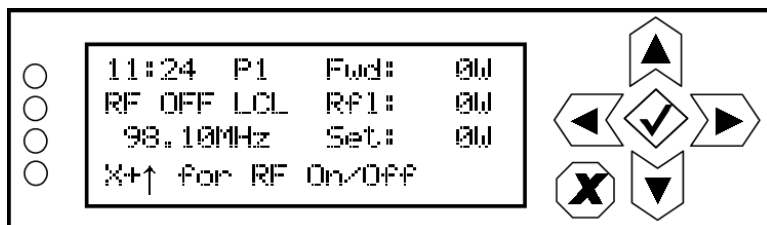
The front panel UI is 4 x 20 character LCD display (see [Figure 2.5](#)). The UI can be controlled by its adjacent keypad. The UI contains a menu-based series of pages that serve specific functions. Similar interfacing, as well as more advanced functionality, is available on the remotely accessed AUI (see [Front Panel UI Screens on page 2-12](#)).

---

### LCD DISPLAY

This display shows all the UI screens. The display's top level screen, used for viewing purposes only, is shown in [Figure 2.4](#).

**Figure 2.4: Top Level Screen**



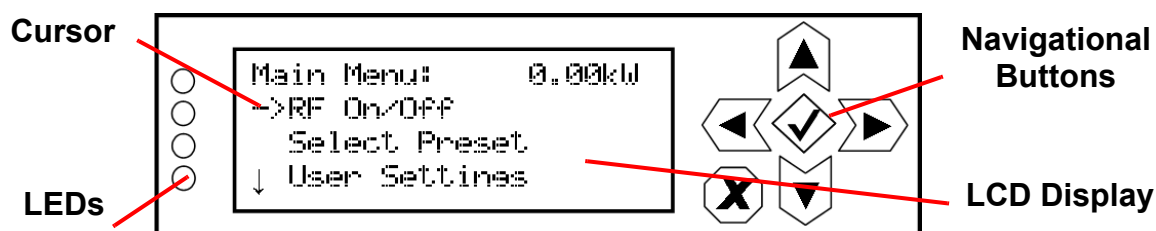
The top level screen displays the following information:

- Line 1: current time, active preset (P#) and the transmitter's actual forward power.
- Line 2: RF operating status (ON or OFF), the local (LCL) or remote (RMT) control status and the transmitter's reflected power level.
- Line 3: operating frequency and the desired power set point.
- Line 4: instructions to turn the transmitter's RF power stage on or off.

### FRONT PANEL UI - MAIN MENU

This main menu is the starting point for navigating through the UI screens. See [Table 2.1 on page 2-12](#) for a list of screens and their basic functions.

**Figure 2.5: Main Menu**



### NAVIGATIONAL BUTTONS

There are six push-buttons on the right-hand side of the LCD display that allow navigation through the UI pages, as well as modifying selected settings.

- Up and down - on menu and list screens, moves cursor up and down through the associated page; on edit screens, increases and decreases the value of a parameter being modified.
- Left - on menu and list screens, exits to the next higher level screen; on edit screens, moves the editing cursor left, as applicable.
- Right - on menu and list screen, goes to the next lower level screen; on edit screens, moves the editing cursor right, as applicable.
- Checkmark - on menu screens, goes to the next lower level screen; on edit screens, acts as an “accept” or “save” function; in some cases the display will prompt its use.
- X - on menu and list screens, exits to the next higher level screen; on edit screens, acts as a “cancel” function; in some cases the display will prompt its use.

### TURNING RF ON AND OFF

From any UI screen, pressing X and the up arrow simultaneously, toggles the RF on/off status. You can also use the Main Menu -> RF On/Off screen to toggle the status.

### SAVING SETTINGS

Many of the UI screens allow for modifying a selected setting. Use the checkmark button to save a change. Use the X button to cancel a change and revert back to the previously stored value.

### LEDs

There are four LEDs on the left-hand side of the LCD display that provide the operational status of various sections of the transmitter - Exciter, Power Amplifier, Output Network and Power Supply (see [Figure 2.5 on page 2-10](#)). The LEDs can glow green, amber or red. Typically, green indicates normal operation, amber indicates a warning, and red indicates a fault or error. Refer to the Troubleshooting section for more detailed information on LED status.

## FRONT PANEL UI SCREENS

Table 2.1 defines the available front panel display screens.

**Table 2.1: Front Panel UI Screens**

UI Screen	Function	See Page
First Time Setup Screens	Guides the user through initial setup of the transmitter. Provides prompts to set frequency, output power and audio input. Refer to the <i>VS Series Quick Start Guide</i> , provided in the transmitter's packing box, for details.	VS Series Quick-Start Guide
Main Menu	Choose options and navigate to other screens.	<a href="#">page 2-10</a>
RF On/Off	Turn RF On and Off	<a href="#">page 2-11</a>
Select Preset	Select and activate a user-defined preset.	<a href="#">page 2-75</a>
User Settings - Edit Presets	Edit various parameters for a user-defined preset (see the following rows for all Edit Presets options).	<a href="#">page 2-75</a>
User Settings - Edit Presets - Output Power	Edit the selected preset's output power.	<a href="#">page 2-76</a>
User Settings - Edit Presets - Frequency	Edit the selected preset's operating frequency.	<a href="#">page 2-78</a>
User Settings - Edit Presets - Main Audio	Edit the selected preset's main audio characteristics such as source, stereo mode, pre-emphasis, low pass filtering.	<a href="#">page 2-80</a>
User Settings - Edit Presets - Backup Audio	Enable and edit the selected preset's backup audio characteristics such as source, stereo mode, pre-emphasis and low pass filtering.	<a href="#">page 2-82</a>
User Settings - Edit Presets - Pilot Settings	Edit the selected preset's pilot settings such as level, phase and 1 PPS synchronization.	<a href="#">page 2-83</a>
User Settings - Edit Presets - SCA Settings	Edit the selected preset's SCA settings such as, MPX SCAs, MPX SCA input and internal SCA (1 and 2) generator characteristics.	<a href="#">page 2-84</a>
User Settings - Edit Presets - RDS Settings	Edit the selected preset's RDS settings such as enable/disable, data source, baud rate, level, phase, program type, alternate frequency data, etc.	<a href="#">page 2-86</a>
User Settings - Edit Presets - Limiter Settings	Edit the selected preset's limiter settings. Limiter types include hard limiter, AGC limiter and 2-slope limiter among others.	<a href="#">page 2-89</a>

**Table 2.1: Front Panel UI Screens**

UI Screen	Function	See Page
User Settings - Edit Presets - Mod Loss	Edit the selected preset's modulation loss functionality, such as enable/disable, setting threshold, setting timeout period, setting resulting action and selecting a backup preset.	<a href="#">page 2-93</a>
User Settings - Edit Presets - Audio Delay	Edit the selected preset's audio delay.	<a href="#">page 2-95</a>
User Settings - Edit Presets - Copy Another Preset	Copy the selected preset's settings to another preset.	<a href="#">page 2-95</a>
User Settings - Set Clock	Set precise time and date.	<a href="#">page 2-143</a>
User Settings - Network Settings	View and/or set network information such as MAC address (view only), DHCP on/off status, IP address, netmask and gateway.	<a href="#">page 2-151</a>
User Settings - Pilot Sample	Set the pilot sample level for the rear panel BNC connector.	<a href="#">page 2-151</a>
User Settings - Signal Gen	Enable/disable and setup the internal signal generator.	<a href="#">page 2-155</a>
User Settings - Station ID	Set station ID parameters for re-broadcasting primary information as a secondary station.	<a href="#">page 2-157</a>
User Settings - Ext. 10 MHz Inp	Enable/disable the use of an external 10 MHz signal.	<a href="#">page 2-138</a>
User Settings - Scheduler	Set up scheduler	<a href="#">page 2-178</a>
User Settings - FM Mask	Select the FM mask - FCC, ETSI or None (turns off mask).	<a href="#">page 2-140</a>
User Settings - Audio Low	Set the low audio thresholds and associated timeout delays.	<a href="#">page 2-149</a>
User Settings - Fwd Low	Set the low forward power and very low forward power thresholds.	<a href="#">page 2-159</a>
User Settings - Turn-On Delay	Set the transmitter turn-on delay period.	<a href="#">page 2-160</a>
User Settings - Ramp-Up Speed	Set the transmitter's ramp-up speed.	<a href="#">page 2-161</a>
Local/Remote	Select local or remote control of the transmitter.	<a href="#">page 2-96</a>



**Table 2.1: Front Panel UI Screens**

UI Screen	Function	See Page
View Status - View Alarms	View all active transmitter alarms.	<a href="#">page 2-28</a>
View Status - View Meters	View the levels of various transmitter parameters, including forward power, reflected power, PA voltage, PA current and low level dc supply voltages.	<a href="#">page 2-52</a>
View Status - View Log	View the transmitter's events log, including alarms, commands, etc.	<a href="#">page 2-28</a>
View Status - Clear Log	Clear the transmitter's events log.	<a href="#">page 2-28</a>
View Status - View SW Versions	View the versions of installed software	<a href="#">page 2-29</a>
View Status - View RDS Demod	View the demodulated RDS content applied to the internally generated RDS carrier. <b>NOTE:</b> does not demodulate the RDS content of an externally generated MPX signal. Menu item is displayed only when RDS is enabled (ON) in the preset.	<a href="#">page 2-29</a>
Reset Alarms	Initiate an attempt to reset all alarms controlled by latched protection circuits.	<a href="#">page 2-96</a>
System Settings	Edit various transmitter system settings (see other System Settings options in this table).	<a href="#">page 2-111</a>
System Settings - Host Reboot	Initiate a reset of the exciter/control PWB's host processor.	<a href="#">page 2-112</a>
System Settings - OS Recovery	Initiate a recovery reset of the operating system in the event of a failed software upgrade.	<a href="#">page 2-112</a>
System Settings - Host Watchdog	Enable, disable or force a reset of the ARM watchdog feature.	<a href="#">page 2-113</a>
System Settings - Console Select	Factory set; no user adjustments required.	-
System Settings - Firmware Update	Perform a software upgrade on the transmitter.	<a href="#">page 2-114</a>
System Settings - LCD Settings	Set the front panel display's contrast, backlight and timeout.	<a href="#">page 2-114</a>

**Table 2.1: Front Panel UI Screens**

UI Screen	Function	See Page
System Settings - Exciter TCXO	Calibrate the internal clock to a user supplied external high precision 10 MHz clock reference	<a href="#">page 2-108</a>
System Settings - HD Optimizer	Set parameters for the HD Optimizer, which can be used to maximize the efficiency of the transmitter's RF spectrum.	<a href="#">page 2-105</a>
System Settings - HW Config	Configure various system hardware parameters (see other System Settings - HW Config options in this table).	-
System Settings - HW Config - Installed Exc	Select either internal or external exciter.	<a href="#">page 2-117</a>
System Settings - HW Config - Audio Processor	Set audio processor to none or Orban Inside.	<a href="#">page 2-186</a>
System Settings - FM Polarity	Set the polarity for FM deviation; positive modulation signal yields positive frequency deviation or negative modulating signal yields positive frequency deviation.	<a href="#">page 2-110</a>
System Settings - Factory Settings	Sets critical thresholds, calibration values and exciter tilt values for key transmitter parameters. These settings are established at the factory and do not normally require user adjustment (see other System Settings - Factory Settings options in this table).	-
System Settings - Factory Settings - Thresholds	Factory set; no user adjustments required.	<a href="#">page 2-119</a>
System Settings - Factory Settings - Calibration	Set calibration values or run calibration routines for various parameters (e.g., forward/reflected power, program input levels, etc.).	<a href="#">page 2-120</a>
System Settings - Factory Settings - Exciter Tilt	Factory set; no user adjustments required.	<a href="#">page 2-122</a>
Remote I/O	Configure the remote inputs, remote outputs, analog outputs and site control features for the transmitter.	<a href="#">page 2-172</a>
Help	Provides instructions for navigating through the front panel UI screens.	-

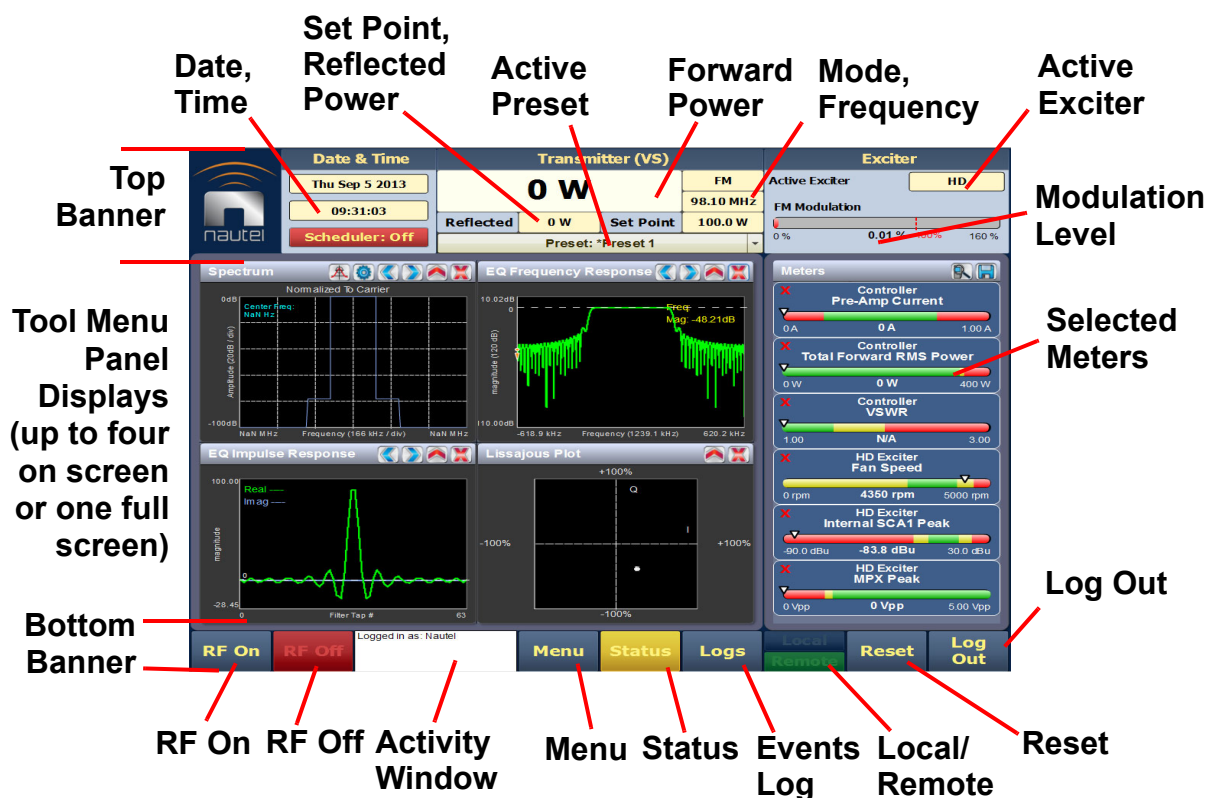
## ADVANCED USER INTERFACE

The VS2.5's advanced user interface (AUI) (see [Figure 2.6](#)) is available via remote connection only. To access the AUI, you need a PC (and a web browser) that is connected to the VS2.5 - directly or through a switch - via its rear panel LAN connection (A1J8A). The AUI has a wide range of displays, including:

- Tool menu panels (spectrum analyzer, signal constellation, Lissajous plot, etc.)
- Real-time meters
- Detailed transmitter status and events log
- Presets
- Hardware configuration
- User accounts
- Software configuration
- Remote input/output configuration

Each AUI page provides information about a specific transmitter function. All navigation through the AUI pages begins on the main screen (or Home page), shown in [Figure 2.6](#).

**Figure 2.6: Using the AUI (Home page shown)**



The top banner is permanent on all AUI pages and includes:

**Nautel Logo:** From any page, click the Nautel logo to log out and return to the login window.

**Date & Time:** Displays day, month, year and current time. From any AUI page, click the date or time to go to the Time Setup page (see [Setting the Clock on page 2-141](#)).

**Active Preset:** Displays the name of the active preset, power set point based on the active preset, current forward power and reflected power levels, as well as the operating mode and carrier frequency (see [Activating presets using the AUI on page 2-55](#)).

**Active Exciter:** Displays the active exciter (internal or external) and the FM modulation, with rms (yellow) and peak (red) values.

The bottom banner is also permanent on all AUI pages and includes:

**RF On:** Click to enable the transmitter's RF power stage.

**RF Off:** Click to disable the transmitter's RF power stage.

**Activity Window:** Displays various messages to reflect specific user interface commands, such as RF on/off, local/remote control, or reset.

**Menu:** Click to display the Menu page, which allows navigation to various other pages (see [AUI Menu page on page 2-21](#)).

**Status:** Click to display the Transmitter Status page (see [Viewing Transmitter Status on page 2-97](#)), which provides current alarm and status details for the transmitter. When the Status button is red, one or more alarms of severity level 10 is being reported; the transmitter is in an 'off-air' state. When the Status button is orange, one or more alarms of severity level 5 (but none of severity level 10) is being reported, but the transmitter is still 'on-air', possibly at reduced power. When the Status button is green, the transmitter is operating normally. In this case, there are no alarms being reported, or there is one or more alarms of severity level 1 (but none of severity level 5 or 10). This page is also available through the Menu page.

**Log:** Click to shortcut to the Transmitter Log page, which displays historical alarm and status records for the transmitter (see [Viewing Transmitter Log on page 2-23](#)).

**Local/Remote:** Displays the operational control status of the transmitter. If Local is highlighted green, only local control of the transmitter is possible. If both Local and Remote are highlighted green, both local and remote controls are enabled. To change the local/remote status from the front panel display, see [Enabling Remote Control on page 2-96](#).

**Reset:** Resets protection circuits and power supplies that were inhibited, but are now alarm-free. To initiate an alarm reset from the front panel UI, see [Resetting Alarms on page 2-96](#).

**Log Out:** Click to log out of the AUI session and return to the login menu. To log in again, use your remote PC's keyboard to enter your Username and Password, then click the Submit button. If you do not have a user account, see [Setting User Accounts - see page 2-123](#).

The displays between the top and bottom menus, contains user selected pages. These pages provide access to a variety of AUI functions such as transmitter status and hardware settings. The following paragraphs describes how to use these pages.

## LOGGING INTO THE AUI

The transmitter's AUI provides a means to restrict access to transmitter control functions to authorized users only. There are user accounts that can be pre-defined to set access restriction from read-only (no control) and full-administrative control.

Access the AUI using a web browser as follows:

1. Configure your network settings. This must be performed locally, using the front panel UI (see [Network Settings on page 2-151](#)).
2. On your router or firewall software, open ports **3501** (3501 is factory default; use corresponding other port if changed) and **80** and close (restrict access to) all other ports. If you are using RDS data, open port **7005**. If you are using SNMP, open port **161** (Agent) or **162** (Traps).
3. When properly configured as noted above, the login menu (see [Figure 2.7 on page 2-19](#)) will appear in your web browser when the IP address is accessed. Your IP address and any login messages appear in a box at the top, beside the logo.

If the login menu does not appear, then your login may not be properly configured and you should consult the documentation for the User Accounts page ([System Settings on page 2-98](#)).

4. Log in to the AUI by entering the appropriate parameters in the login window.
  - In the **Language** field, click the down-arrow to review a drop-down menu displaying the available language options, and select one.
  - In the **User** field, enter the username. Default is "Nautel".
  - In the **Password** field, enter the password. Default is blank.

**Figure 2.7: AUI Login Menu**

IP address and login messages

**Note:**

The Nautel AUI is factory configured with a default login username and password. Nautel recommends that you change the password to improve overall system security (see [Changing the Password on page 2-124](#)).

Also, you should change the OS (operating system) password. This is a unique, factory set password that is referenced in your Proof of Performance documents. See [“Changing the OS Password” on page 8-10](#) of the Installation Manual for instructions to change the password.

- Click **Submit** to accept your login parameters and display the AUI home page ([Figure 2.6 on page 2-16](#)). Note: The opening screen (the Home page) will have the layout from the previous login session.

**Note:**

If you do not have a user account, it must be set up by an existing user with proper permissions. See [Adding an Account on page 2-124](#).

## AUI PAGES

Table 2.2 defines the available AUI pages.

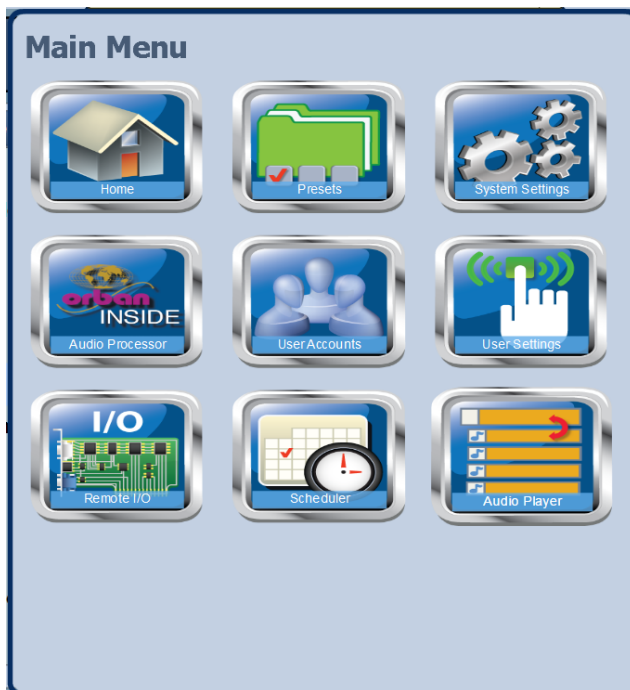
**Table 2.2: AUI Pages**

AUI Page	Function	See Page
Home	View meters, tool menu panels, choose options and navigate to other pages.	<a href="#">page 2-16</a>
Menu	Choose options and navigate to other pages.	<a href="#">page 2-21</a>
Log	View and analyze transmitter events.	<a href="#">page 2-23</a>
Tool Menu	Choose tool menu panel options.	<a href="#">page 2-31</a>
System Review	Choose meters for display.	<a href="#">page 2-47</a>
Menu - Presets	Activate and edit user-defined presets.	<a href="#">page 2-54</a>
Transmitter Status	View current active faults and operational status.	<a href="#">page 2-97</a>
Menu - User Accounts	Set user permission rights and define user account information.	<a href="#">page 2-123</a>
Menu - System Settings	Perform AUI and exciter reboots, calibrate the exciter TCXO, perform software upgrades and calibrate audio inputs levels, if necessary (factory calibrated), establish IBOC settings, if necessary and set FM polarity.	<a href="#">page 2-98</a>
Menu - Audio Processor (if installed)	Manage the Orban Inside audio processor, if installed.	<a href="#">page 2-184</a>
Menu - User Accounts	Set user permission rights and define user account information.	<a href="#">page 2-123</a>
Menu - User Settings	Configure email and alarm notification parameters, configure SNMP parameters, capture transmitter critical parameters, configure the use of an external 10 MHz source, set the system clock and manage NTP servers, set low audio thresholds and more.	<a href="#">page 2-126</a>
Menu - Remote I/O	Define remote inputs and outputs, monitor analog outputs and configure the site control feature.	<a href="#">page 2-162</a>
Menu - Scheduler	Define a calendar-based schedule for preset usage.	<a href="#">page 2-176</a>
Menu - Playlist	Manage the contents of audio playlists and streams.	<a href="#">page 2-179</a>

## AUI MENU PAGE

From the home page, click the Menu button to view the Menu page (see [Figure 2.8](#)). From this page, you can select one of the following sub-menus:

**Figure 2.8: Main Menu Page**



- Select Home to return to the home page (see [AUI Pages on page 2-20](#)).
- Select Presets to load, edit, or save presets (see [Managing Presets on page 2-54](#)).
- Select System Settings to access pages that allow rebooting of the AUI or active exciter, calibration of the exciter TCXO, upgrading of software files and calibration of audio inputs (see [System Settings on page 2-98](#)).
- Select User Accounts to access a page that displays a list of users with access to the AUI. Depending on the user's permission level, allows editing of user accounts (see [Setting User Accounts on page 2-123](#)).



- Select **User Settings** to access a page that provides help with performing email configuration, alarm notifications, SNMP configuration, capturing critical transmitter data, using an external 10 MHz source, setting a spectrum mask, setting the system date and time, configuring NTP servers, using Nautel Phone Home technology, setting the call sign/ID and setting low audio (see [Setting Audio Low Thresholds on page 2-148](#)).
- Select **Remote I/O** to access a page that allows assignation of remote inputs, remote outputs and analog outputs (see [Remote I/O Settings - Using the AUI on page 2-162](#)).
- Select **Scheduler** to access a page that allows setting of daily preset schedules (see [Scheduler on page 2-176](#)).
- Select **Audio Player** to access a page that allows managing of program playlists and streams (see [Audio Player on page 2-179](#)).
- Select **Audio Processor**, if the Orban Inside card has been installed and enabled, to access pages that allow creation and management of Orban audio processor presets (see [Enabling and Operating the Orban Audio Processor on page 2-184](#)).

## VIEWING TRANSMITTER LOG

This section includes the following topics:

- [Transmitter Log - Using the AUI](#)
- [Managing the log - see page 2-24](#)
- [Transmitter Log - Using the front panel - see page 2-28](#)

You can view transmitter log information using the remote AUI (see [Transmitter Log - Using the AUI on page 2-23](#)) or the local front panel UI (see [Transmitter Log - Using the front panel on page 2-28](#)).

### TRANSMITTER LOG - USING THE AUI

You can view the VS2.5's events log using the AUI's [Log page](#) - see [Figure 2.9](#). This page shows a configurable log of all transmitter events. To view the [Log page](#), click the Log button in the bottom banner of any AUI screen.

**Figure 2.9: Log page**

**Transmitter Log**

Page 1/20

Device	Event	State	Severity	Time of Event
HD Exciter	No HD Data Link	✔	⚠	Thu Sep 05 2013 10:30:48 310ms
HD Exciter	No HD Data Link	✔	⚠	Thu Sep 05 2013 10:30:47 310ms
HD Exciter	Licensing Error	✔	⚠	Thu Sep 05 2013 10:29:42 470ms
HD Exciter	Licensing Error	⚠	⚠	Thu Sep 05 2013 10:29:42 390ms
HD Exciter	Licensing Error	✔	⚠	Thu Sep 05 2013 10:21:14 590ms
HD Exciter	Licensing Error	⚠	⚠	Thu Sep 05 2013 10:21:14 490ms
HD Exciter	Licensing Error	✔	⚠	Thu Sep 05 2013 10:12:53 470ms
HD Exciter	Licensing Error	⚠	⚠	Thu Sep 05 2013 10:12:53 350ms
HD Exciter	Licensing Error	✔	⚠	Thu Sep 05 2013 09:40:32 670ms
HD Exciter	Licensing Error	⚠	⚠	Thu Sep 05 2013 09:40:32 590ms
HD Exciter	Licensing Error	✔	⚠	Thu Sep 05 2013 09:36:52 370ms
HD Exciter	Licensing Error	⚠	⚠	Thu Sep 05 2013 09:36:52 270ms

Page number of displayed page

Selects item at top of current page

Selects next lower page items

Scrolls up one item

Scrolls down one item

Selects next higher page items

Selects item at bottom of current page

The main screen displays a chronological listing of events. Depending on the selections made in the Log Manager screen (see [Managing the log on page 2-24](#)), the events displayed may be filtered by the originating device (Controller or Exciter), and the time of occurrence.

Refer to the *VS2.5 Troubleshooting Manual* to cross-reference the alarm name to possible causes and troubleshooting tips.

The number of log matches displayed is shown below the **Log Manager** button (e.g., 564 Matches Sorted by Time of Event). You can scroll through the list using the scroll bar or the up and down arrow buttons to the right of the scroll bar. When there are more than 100 matches in the list, a **Page #/#** tab will appear to allow viewing of further listings. In this case, click on **Page #/#**, select the desired page from the **Select a Page** window, then click **OK** to view that page or **Cancel** to return to the **Transmitter Log** page. You can also scroll through the pages using the appropriate arrow button on the right-hand side of the display (see [Figure 2.9 on page 2-23](#)). The columns in the display indicate specific information about the event:

- **Device** indicates the origin device of the event (Controller, Exciter, etc.).
- **Event** indicates the event name.
- **State** indicates if the event is active (red bell) or cleared (green checkmark) and in some cases, whether the RF was turned on or off or a specific parameter value (in V, A, degrees, etc.) (see **Legend** under **Log Manager**, [Figure 2.14 on page 2-27](#)).
- **Severity** indicates the effects on transmitter operation [a single orange ! indicates low severity (RF output not affected); a single red ! indicates medium severity (RF output is reduced); three red ! indicates high severity (RF output is inhibited)].
- **Time of Event** indicates the time and date that the event that occurred.

## MANAGING THE LOG

You can manage the VS2.5 AUI's events log by clicking on the **Log Manager** button (see [Figure 2.10](#)). This screen provides options to perform various event monitoring operations such as filtering, copying, deletion and statistical analysis. Click the **OK** button or the **Cancel** button when done.

**Figure 2.10: Log Manager options (Filter Logs shown)**



### FILTER LOGS

You can filter transmitter events based on their origin or date by clicking the Filter Logs button in the log manager (see [Figure 2.10 on page 2-24](#)).

Click the Device Type drop-down arrow, and select the desired device type to filter events based on the type selected. Click the OK button or the Cancel button when done.

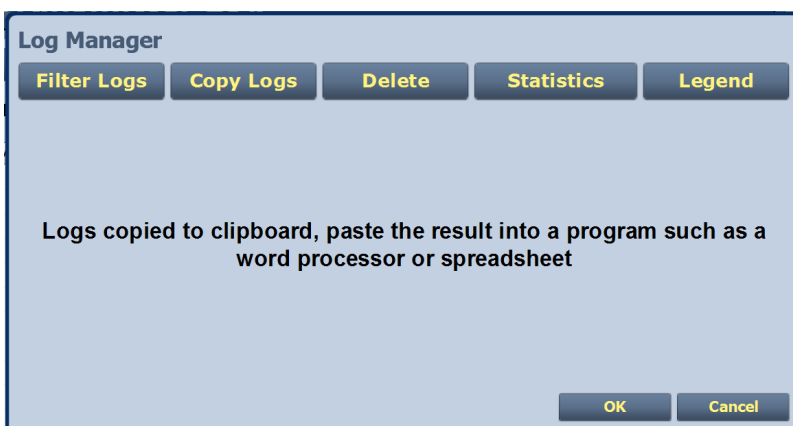
- All - displays all transmitter events
- Controller - displays controller events only
- Exciter - displays exciter events only

Click the Filter by Date checkbox to filter events based on a selected date and time range, and the device type selected. Click the OK button when done. Click the Cancel button to close this window and discard changes.

### COPY LOGS


You can create a copy of all the logs in the selected list (copied to the remote user's computer clipboard) by clicking on the Copy Logs button in the log manager (see [Figure 2.11](#)). You can paste the tab-delimited text copy of the logs into a text editing program such as Word, Excel, Notepad, etc. Click Cancel to close this window.

**Figure 2.11: Copy Logs**



### DELETE

You can delete all events or a selection of events by clicking on the Delete button in the log manager (see [Figure 2.12 on page 2-26](#)).

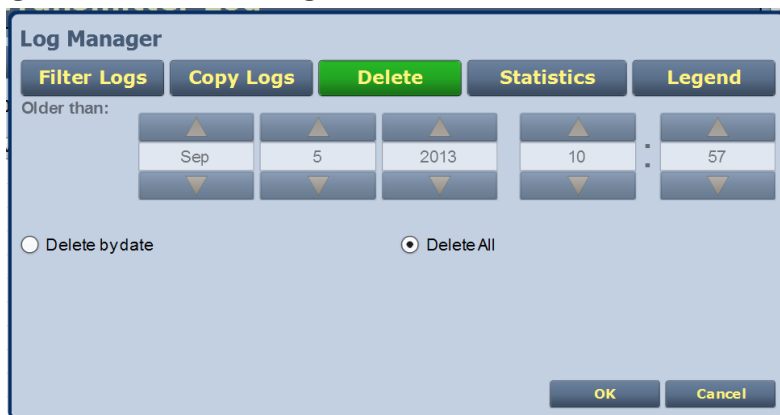
 *Note:*  
Clearing the remote AUI's logs does not clear the logs shown in the front panel UI.

Click the Delete All checkbox and click OK to delete all events.

Click the Delete by date checkbox to allow deletion of events that occurred prior to (Older than) a user-specified date and time. Use the up and down arrows to select the date and time and click OK to delete the specified events.

Click the Cancel button to close this window and discard changes.

**Figure 2.12: Delete Logs**



#### STATISTICS

You can view statistical information on the events being displayed by clicking on the Statistics button in the log manager (see [Figure 2.13 on page 2-27](#)).



*Note:*

*Only the events subject to the user-defined filtering parameters will be displayed on the Statistics screen.*

The Statistics screen displays the events that occurred in the filtered period as well as the time and date of the earliest and latest event occurrence for each. You can move through the list using the scroll bar (if applicable) or the up and down arrow buttons to the right of the scroll bar. The columns in the display indicate specific information about the events:

- Device indicates the origin device of the event (Controller, Exciter or All).
- Event indicates the event name.
- Severity indicates how the event affects operation [a single orange ! indicates low severity (RF output not affected); a single red ! indicates medium severity (RF output is reduced); three red ! indicates high severity (RF output is inhibited)].
- # Events indicates the number of occurrences of that event in the filtered period.
- Earliest indicates the time and date of the first event, in the filtered period.
- Latest indicates the time and date of the latest event, in the filtered period.

Click OK or Cancel to close this window.

Figure 2.13: Log Statistics

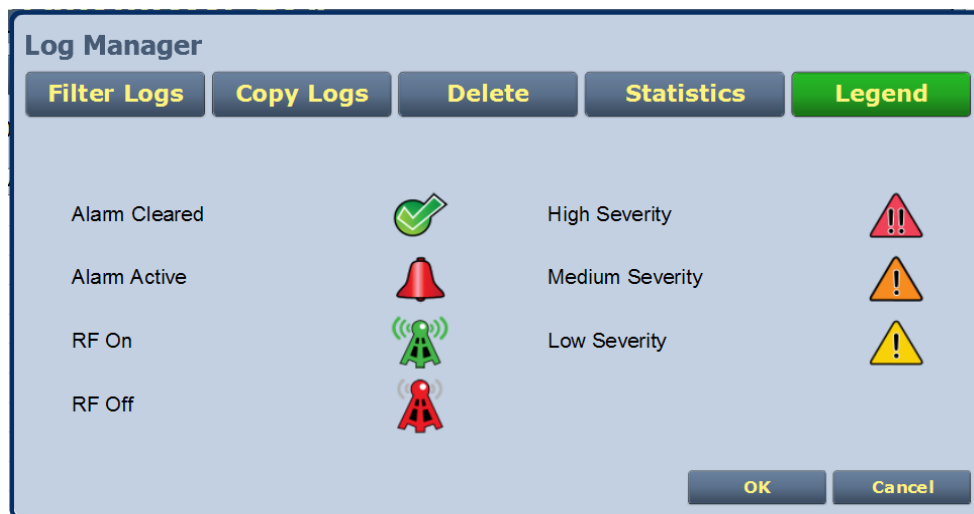


LEGEND

Click on the Legend button in the log manager (see Figure 2.14) to display a legend that describes the meaning of the symbols shown in the State and Severity columns of the Log page.

Click OK or Cancel to close this window.


Figure 2.14: Log Manager - Legend



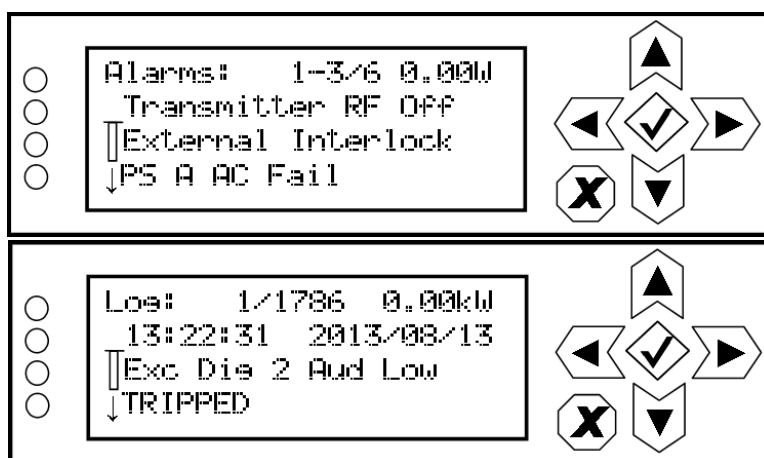
Use the Reset button at the bottom of any AUI screen to attempt to clear any latching alarms that are holding the transmitter in an “off-air” state. If the offending alarm has cleared, the transmitter should resume operation. See Reset: on page 2-18.

### TRANSMITTER LOG - USING THE FRONT PANEL

When you select View Status -> Alarms or View Status -> View Log from the Main Menu (see [Figure 2.15](#)), you can view various active or logged events, respectively, of the VS2.5. These parameters are displayed on multiple pages of Meters screens.

 *Note:*  
This screen is for viewing purposes only and does not offer the same level of analytical features as the AUI's Log page (see [Figure 2.9 on page 2-23](#)).


**Figure 2.15: View Alarms and View Logs Screens**



**VIEW ALARMS.** The View Alarms screen displays only alarms that are currently active. Older alarms that have cleared may still be present in the View Events screen.

Use the up and down buttons to scroll through the list of alarms or events. Refer to the *VS2.5 Troubleshooting Manual* to cross-reference the alarm name to possible causes and troubleshooting tips.

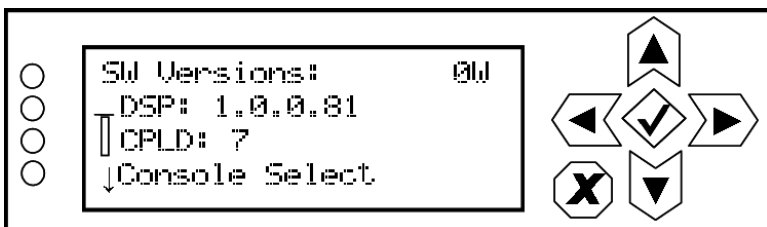
**CLEAR LOG.** When you select Clear Log from the View Status menu, you delete all logged events.

 *Note:*  
Clearing the front panel UI's logs does not clear the logs displayed in the remote AUI.

**RESET ALARMS.** Use the Reset Alarms command in the front panel UI's Main Menu -> Reset Alarms screen to attempt to clear any latching alarms that are holding the transmitter in an "off-air" state. If the offending alarm has cleared, the transmitter should resume operation. See [Resetting Alarms on page 2-96](#).

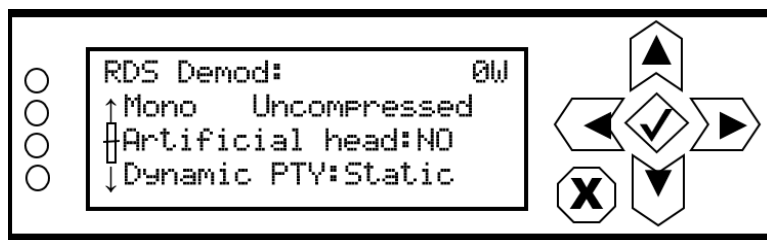
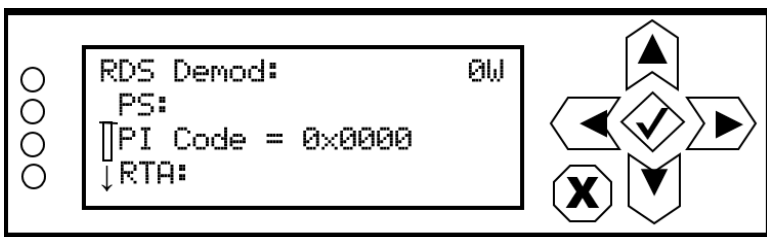
**VIEW SOFTWARE VERSIONS - FRONT PANEL UI.** The View SW Versions screen displays the current versions of the different software being used in the transmitter (see [Figure 2.16](#)).

**Figure 2.16: View Software Versions**



**VIEW RDS DEMOD - FRONT PANEL UI.** The View RDS Demod screen displays decoded data from the internal RDS generator, if enabled (ON) in the associated preset (see [Figure 2.17](#)). The View RDS Demod option is not displayed when RDS is disabled (OFF).

**Figure 2.17: View RDS Demod Screens**





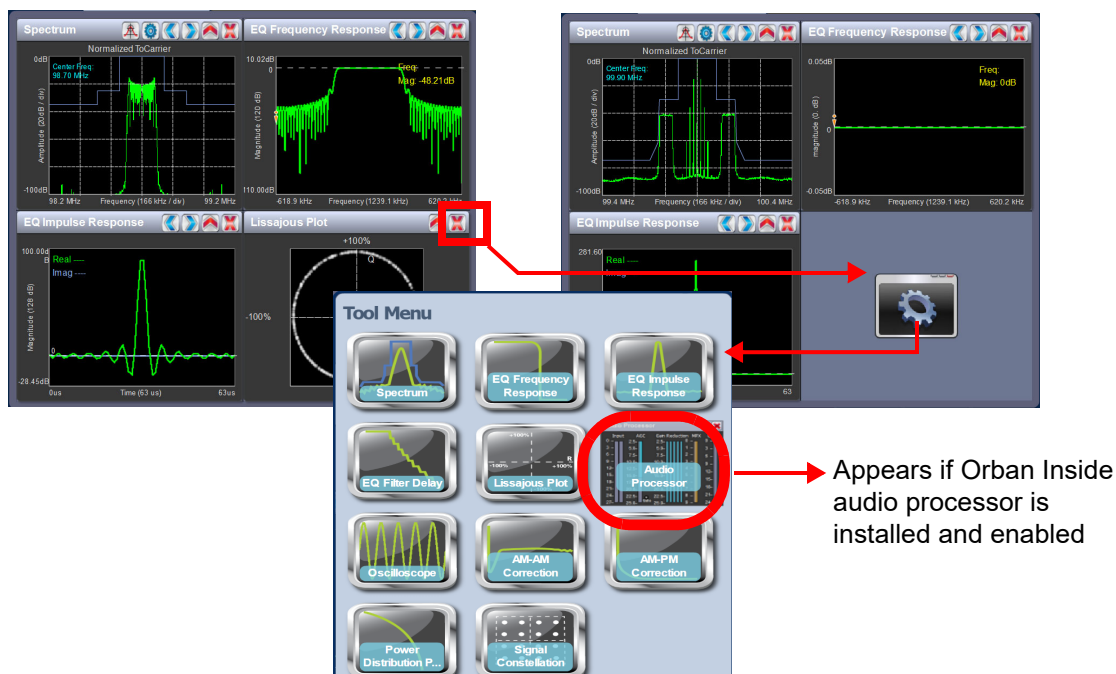
## VIEWING AUI TOOL MENU PANELS

This section includes the following topics:

- Describing AUI Tool Menu Options - see page 2-31
- AUI Tool Menu Panels Procedures - see page 2-33
- Available Instrument Panels - see page 2-35
- Spectrum analyzer - see page 2-35
- Equalizer screens - see page 2-37
- Lissajous plot - see page 2-40
- Oscilloscope - see page 2-41
- AM-AM and AM-PM correction screens - see page 2-43

The VS2.5 AUI provides up to eleven tool menu panels that you can choose to display on the AUI home page (see [Figure 2.18](#)). Up to four tool menu panels can be displayed at one time, including a spectrum analyzer. To view all the tool menu options (see [Figure 2.19 on page 2-31](#)), close one of the existing tool menu panels on the Home page by clicking X in the top, right corner of the tool menu panel, and then click anywhere in the blank space (see [Figure 2.18](#)).

**Figure 2.18: Tool Menus on Home page**



## DESCRIBING AUI TOOL MENU OPTIONS

Click on the desired tool menu panel to display it. See [Table 2.3 on page 2-32](#) for a description of each tool menu panel.

**Figure 2.19: Tool Menu Options**



The AM-AM Correction, AM-PM Correction and Power Distribution tool menu icons appear only when the transmitter is operating with a VSHD exciter.

The Audio Processor icon only appears when the Orban Inside audio processor is installed and enabled.

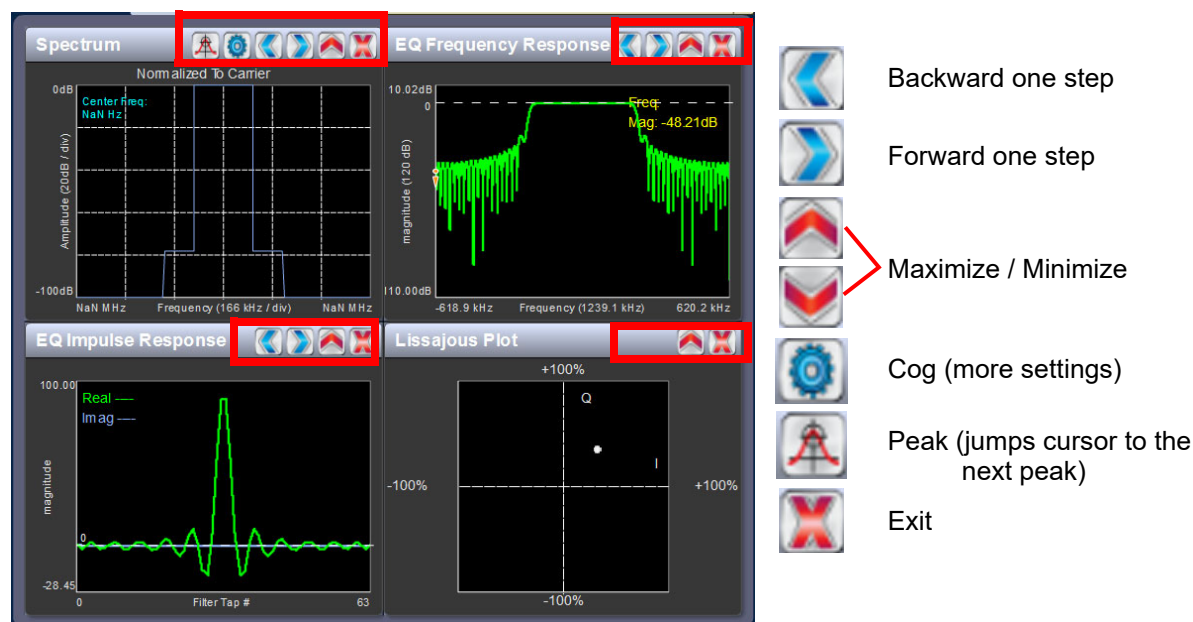
**Table 2.3: Tool Menu Panels**

Tool Menu	Description	Reference
Spectrum	Displays a spectrum analyzer, capable of monitoring various RF sections of the transmitter.	See <a href="#">page 2-35</a>
EQ Frequency Response	Displays the frequency response of the modulator's EQ filter.	See <a href="#">page 2-37</a>
EQ Impulse Response	Displays the impulse response of the modulator's EQ filter.	See <a href="#">page 2-38</a>
EQ Filter Delay	Displays the delay of the modulator's EQ filter across its bandwidth	See <a href="#">page 2-39</a>
Lissajous Plot	Displays a Lissajous figure that represents the relationship between the two applicable channels (either L and R or I and Q).	See <a href="#">page 2-40</a>
Audio Processor (optional)	Appears only when Orban Inside audio processor is installed and enabled. Displays various audio processor meters that indicate levels for inputs, AGC, gain reduction, multiplex (MPX) power and composite. Refer to <a href="#">Enabling and Operating the Orban Audio Processor on page 2-184</a> and the Orban Optimod 5500 manual for detailed information on these meters.	See <a href="#">page 2-184</a>
Oscilloscope	Displays an oscilloscope, capable of monitoring various audio inputs and the precorrection forward/reverse signal.	See <a href="#">page 2-41</a>
AM-AM Correction	<b>Tool menu available only when the transmitter is used with a VSHD exciter.</b> Displays the amplitude compensation being applied to the magnitude signal.	See <a href="#">page 2-43</a>
AM-PM Correction	<b>Tool menu available only when the transmitter is used with a VSHD exciter.</b> Displays the phase compensation being applied to the phase signal.	See <a href="#">page 2-43</a>
Power Distribution	Displays a CCDF plot that indicates the probability of exceeding a given power level, based on the average power level. Aids in determining peak power capability.	See <a href="#">page 2-45</a>
Signal Constellation	Displays the phase and amplitude of the symbols being modulated within an OFDM sub-carrier as dots on a cartesian graph. Also displays timing, MER and data carrier information.	See <a href="#">page 2-46</a>

## AUI TOOL MENU PANELS PROCEDURES

Each instrument panel has a menu bar that may be different from other panels (see

**Figure 2.20: Tools Menu on Home Page**



Each panel has a tool bar at the top of the display

### PROCEDURE TO VIEW INSTRUMENT READINGS ON THE PANEL:

- To display a cursor in the panel, touch the screen where you want the cursor (see [Figure 2.21 on page 2-34](#)). The cursor position is noted in the upper, right-hand corner of the panel (e.g., frequency and amplitude for the spectrum analyzer). Touch in other areas of the instrument to provide a coarse adjustment of the cursor position.
- To make fine adjustments, use the backward and forward buttons (see [Figure 2.20](#)).
- To enlarge/reduce the instrument panel, use the maximize/minimize buttons. Some instrument displays show more information when maximized (e.g., EQ Impulse Response (see [Figure 2.20 on page 2-33](#))).
- To display additional settings in the Spectrum Analyzer panel, touch the “cog” button (see [Figure 2.20](#)). Displays include resolution bandwidth, span, averaging rate and the actual measurement source (transmitter output, audio analyzer, etc.) that is being displayed. Touch the “peak” button (see [Figure 2.23](#)) to place the cursor on the next successive peak in the spectrum.

Figure 2.21: Instrument Cursor Manipulation

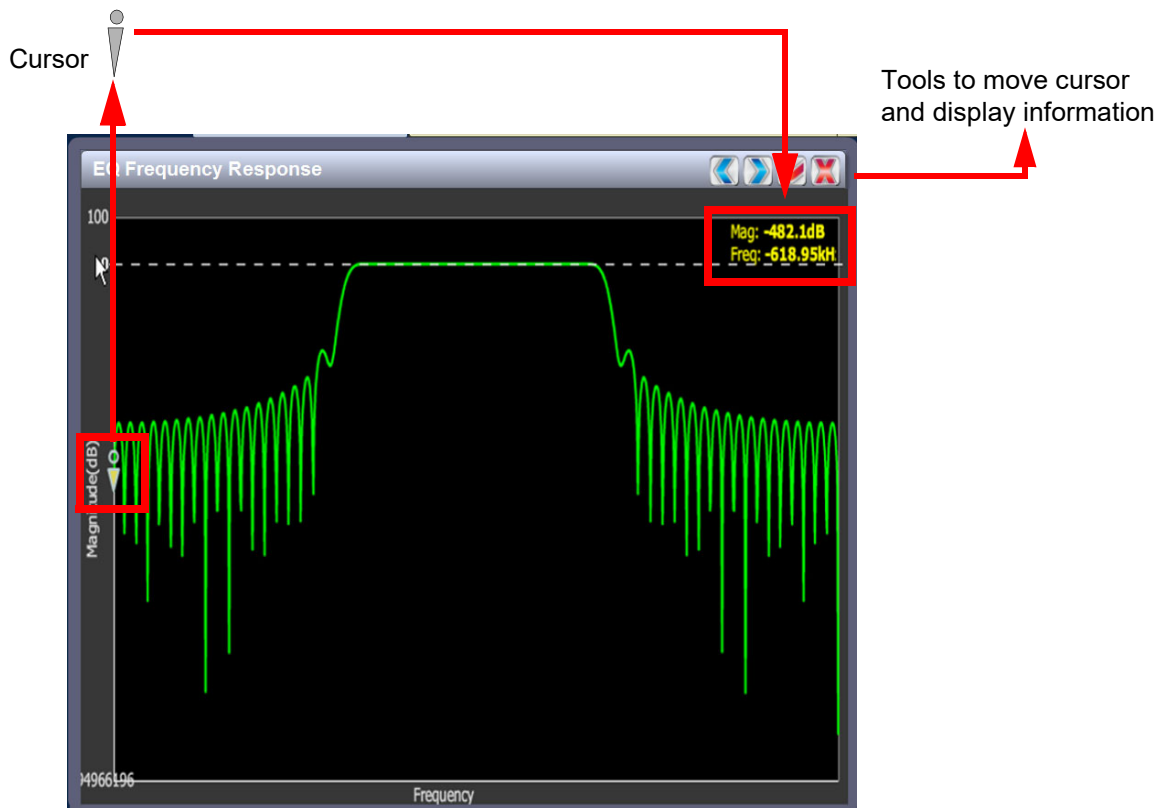
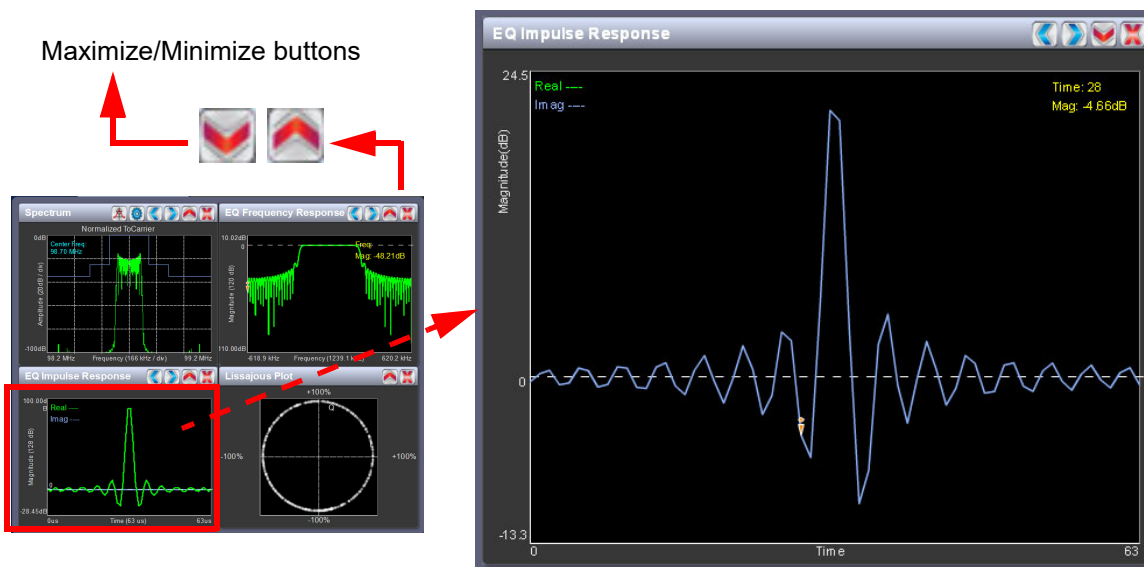
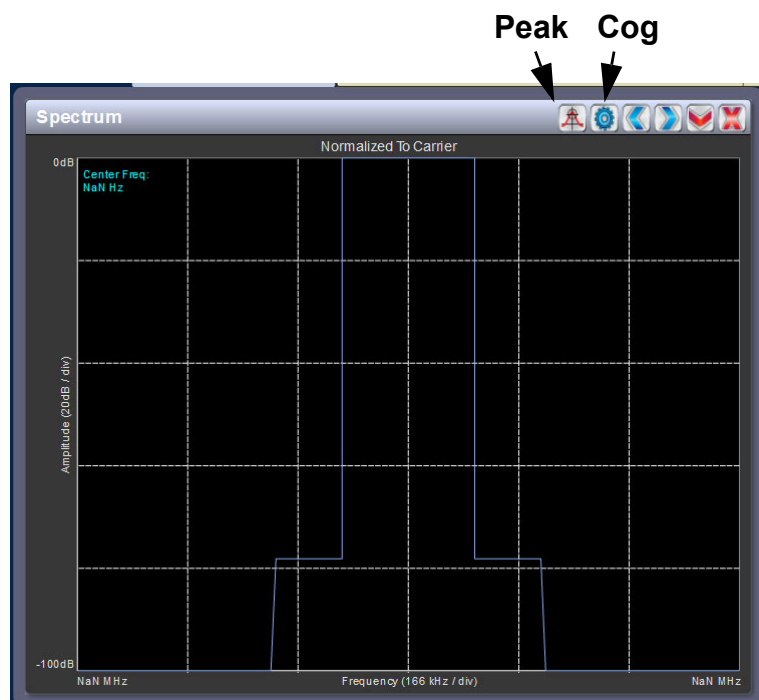


Figure 2.22: Instrument Panel - Expansion Example



## AVAILABLE INSTRUMENT PANELS

Figure 2.23: Spectrum Analyzer



## SPECTRUM ANALYZER

See [Figure 2.23](#). The carrier level is normalized to its unmodulated carrier level at 0 dB. The graph center is always at the carrier frequency, as defined by the active preset's Frequency value.

Masks are shown based on transmission mode and are defined by the latest versions of the following standards:

- IBOC: NRSC-5
- European Standard: ETSI EN 302 018-2
- FCC CFR 47, Part 73.317 and IC BETS-6e



**Note:**

*While very accurate, the spectrum analyzer may display artifacts (spurs) as some operating carrier frequencies that are a function of the analyzer and are not actually present on the output of the transmitter. If these spurious emissions are observed on the spectrum analyzer, Nautel recommends that a calibrated, external spectrum analyzer be used to verify the presence of spurs.*

Click the panel to display a cursor in the approximate area. The cursor position (frequency and amplitude) is noted in the upper, right-hand corner of the panel. Click on other areas of this instrument panel to provide a coarse adjustment of the cursor position.

Use the left and right buttons to make fine adjustments.

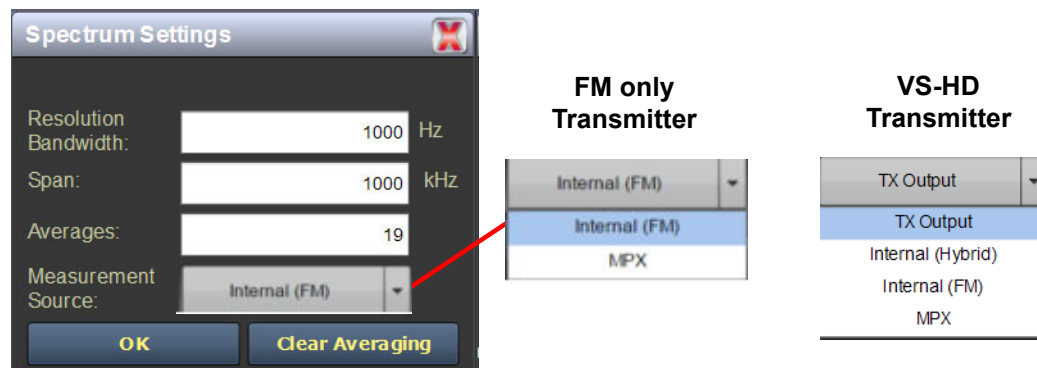
Use the maximize or minimize buttons as required.

Use the “peak” button to place the cursor on the next successive peak (moving left to right) in the spectrum.

Use the “cog” button to gain access to spectrum settings (see [Figure 2.23 on page 2-35](#)) such as:

- **Resolution Bandwidth:** determines the FFT bin size or the smallest frequency that can be resolved. Allowable range is 75 - 10,000 Hz. Default setting is 1000 Hz.
- **Span:** determines the start and stop frequencies of the analyzer with the carrier frequency always at the center. Allowable range is 10 - 1200 kHz. Default setting is 1000 kHz.
- **Averages:** determines the number of averages that the analyzer performs per sweep. Press the **Clear Averaging** button to restart the averaging process. Allowable range is 0 - 100 kHz. Default setting is 19.
- **Measurement Source:** determines the source of the spectrum plot that is being displayed. Selecting **Internal (FM)** uses the exciter’s RF signal, before being equalized (if applicable). FM spectrum analyzer bandwidth is defaulted to 1 MHz, but can be increased to 1.2 MHz. Selecting **MPX** bandwidth displays the entire composite base-band signal (100 kHz wide). For VS-HD systems, selecting **Internal (Hybrid)** displays the signal that will be produced by the exciter and selecting **TX Output** displays the signal at the transmitter’s RF output.

**Figure 2.24: Spectrum Settings**



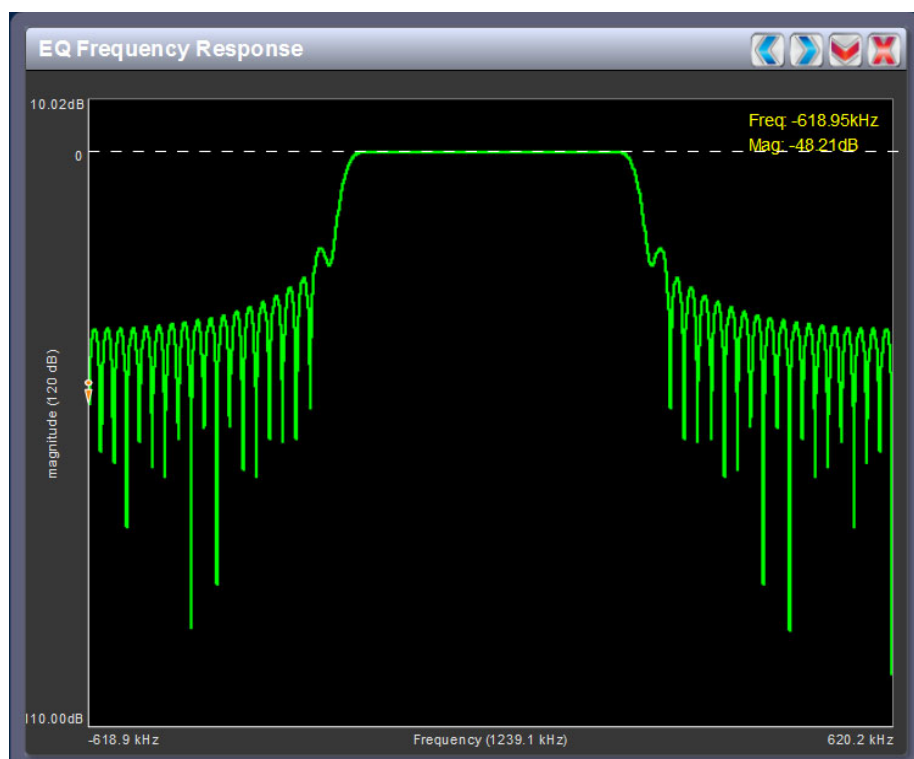
**Note:**

*The FM spectrum analyzer displays the ideal spectrum generated by the DSP. It is not necessarily the same as the spectrum seen at the RF output.*

## EQUALIZER SCREENS

The VS2.5's exciter includes a fixed equalizer to optimize audio performance. There are three menus available in the tool panel - EQ Frequency, EQ Impulse Response and EQ Filter Delay. Coefficients are selected based on your channel frequency. All frequencies shown are relative to the channel frequency.

**Figure 2.25: EQ Frequency Response**



### EQ FREQUENCY RESPONSE

See [Figure 2.25](#). This panel displays the frequency response of the modulator's EQ filter.

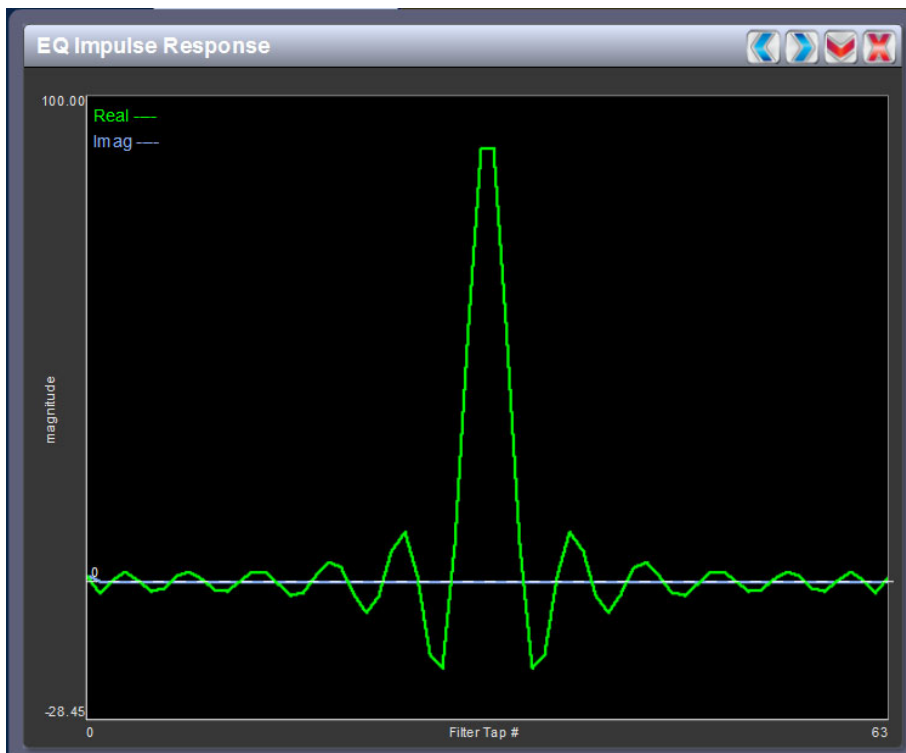
Click on the panel to display a cursor in the approximate area. The cursor position (magnitude and amplitude) is noted in the upper, right-hand corner of the panel. Click in other areas of the panel to provide a coarse adjustment of the cursor position.



Use the left and right buttons to make fine adjustments to the cursor position.

Use the up or down button to maximize (if it was minimized) or minimize (if it was maximized) the panel size.

**Figure 2.26: EQ Impulse Response**



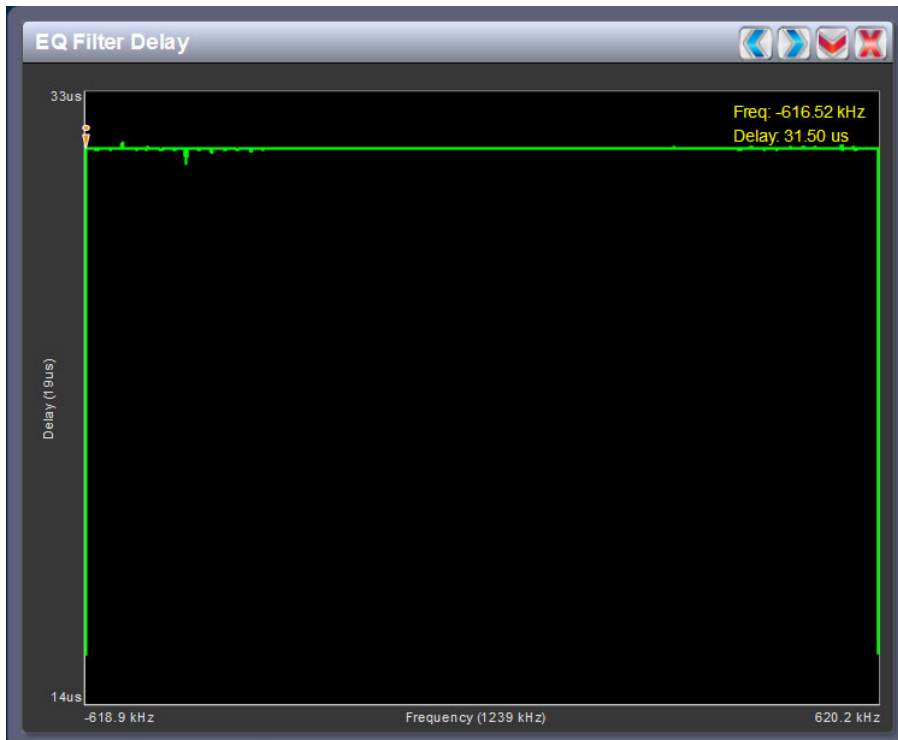
#### EQ IMPULSE RESPONSE

See [Figure 2.26](#). This panel displays the impulse response of the modulator's EQ filter.

Click on the panel to display a cursor in the approximate area. The cursor position (time and magnitude) is noted in the upper, right-hand corner of the panel. Click in other areas of the panel to provide a coarse adjustment of the cursor position.

Use the left and right buttons to make fine adjustments to the cursor position.

Use the up or down button to maximize (if it was minimized) or minimize (if it was maximized) the panel size.

**Figure 2.27: EQ Filter Delay**

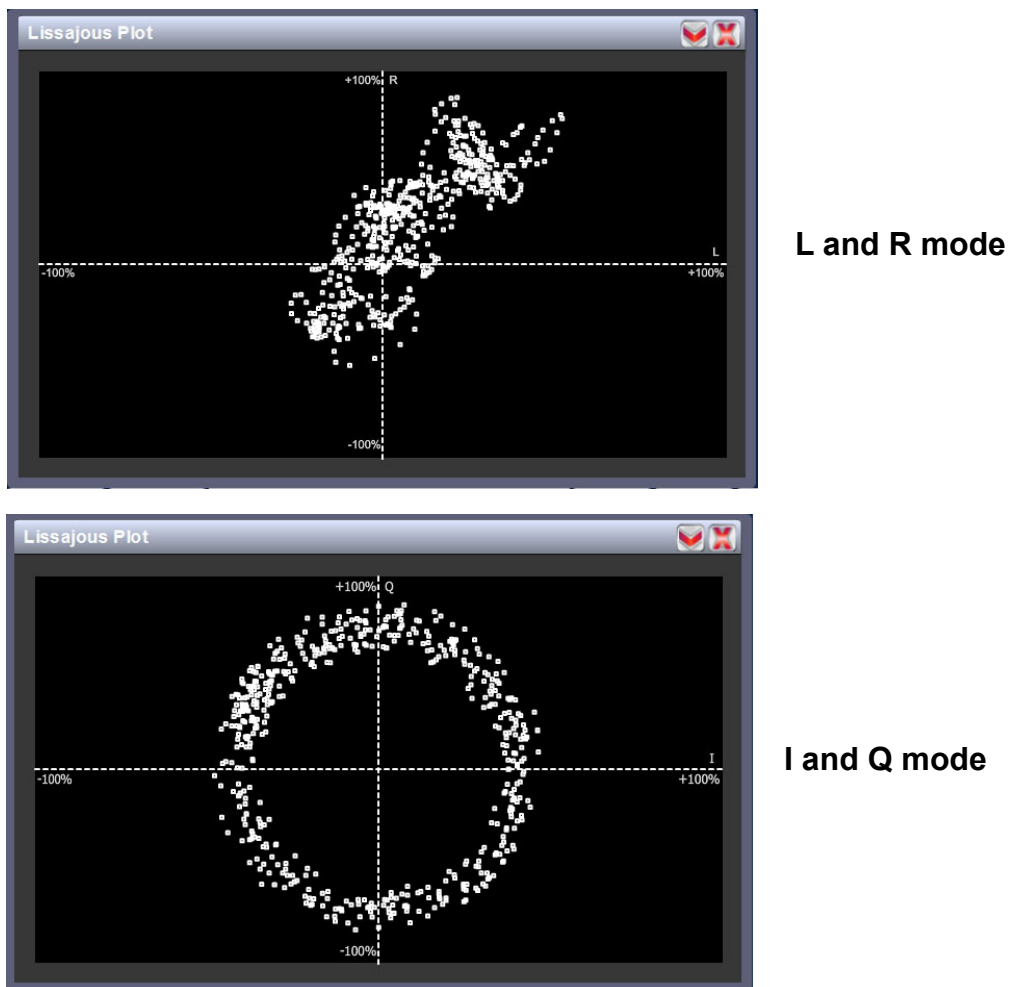
#### EQ FILTER DELAY

See [Figure 2.27](#). This panel displays the delay of the modulator's EQ filter across its bandwidth.

Click on the panel to display a cursor in the approximate area. The cursor position (frequency and delay) is noted in the upper, right-hand corner of the panel. Click in other areas of the panel to provide a coarse adjustment of the cursor position.

Use the left and right buttons to make fine adjustments to the cursor position.

Use the up or down button to maximize (if it was minimized) or minimize (if it was maximized) the panel size.

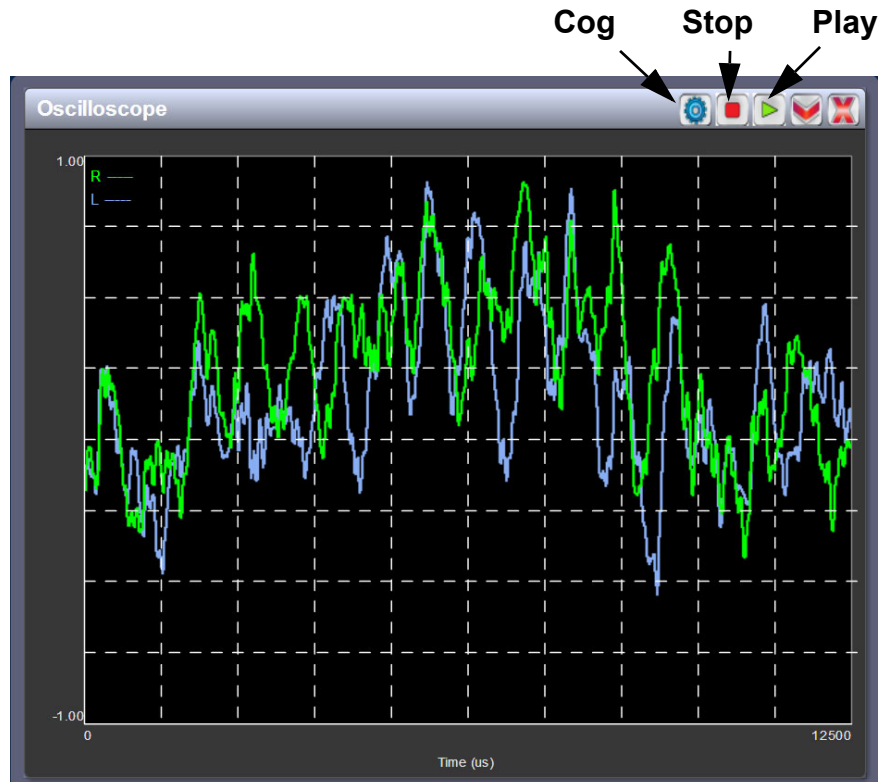
**Figure 2.28: Lissajous Plots**

## LISAJOUS PLOT

See [Figure 2.28](#). This panel displays a Lissajous plot that represents either left and right audio content or a representation of the FM modulated signal (I and Q). I and Q will be automatically selected when using MPX as the main audio source. Left and right audio content is displayed for all other audio sources.

The plot consists of a group of sequential samples to allow signal analysis. In L and R mode, the L+R portion of the signal tends to dominate the plot, resulting in the majority of samples appearing in the lower, left and upper, right quadrants. In I and Q mode, signals that are of equal frequency and 90 degrees out-of-phase result in a circular display.

Use the up or down button to maximize (if it was minimized) or minimize (if it was maximized) the panel size.

**Figure 2.29: Oscilloscope (Left/Right Audio input shown)**

## OSCILLOSCOPE

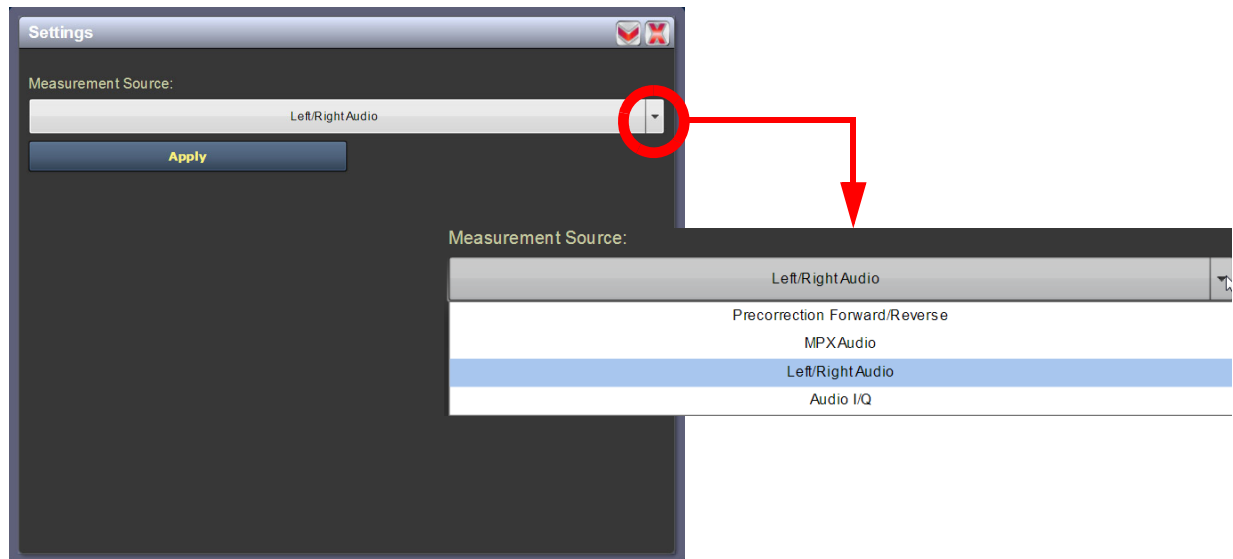
See [Figure 2.29](#). This panel displays an oscilloscope to allow monitoring of audio input parameters. The oscilloscope displays a real-time waveform for the selected audio input (e.g., L/R audio input). The audio input(s) being monitored is displayed in the upper, left-hand corner of the panel (e.g., R in green, L in blue for L/R audio input.) The limits for the amplitude axis (volts/division) and time axis (microseconds/division) are preset in software for each selected input and cannot be adjusted. The following button controls are available:

Use the “cog” button to access the measurement source setting (see [Figure 2.30 on page 2-42](#)). Use the drop-arrow to select from the various options - Precorrection Forward/Reverse (reverse and forward sample signals), MPX Audio, Left/Right Audio (left and right signals) or Audio I/Q (shows I and Q signals).



**Note:**

*If the front panel UI's test signal generator is enabled, the test signal may appear on certain oscilloscope displays. To view the actual audio input's signal, disable the test signal generator (see [“Signal Generator” on page 2-155](#)).*

**Figure 2.30: Measurement Source Settings**

Use the 'stop' button to display a snapshot of the waveform for analysis, printing, etc.

Use the 'play' button to resume the live, real-time display of the waveform.

Use the up or down button to maximize (if it was minimized) or minimize (if it was maximized) the panel size.

## AM-AM AND AM-PM CORRECTION SCREENS

Available only when the transmitter is used with a VSHD exciter. When the transmitter is operating with digital carriers, the exciter linearizes the transmitter's RF drive signal by performing adaptive pre-correction. There are two correction parameters - AM-AM Correction (see Figure 2.31) and AM-PM Correction (see Figure 2.32 on page 2-44), which can be viewed as instrument panels.

**Figure 2.31: AM-AM Correction**



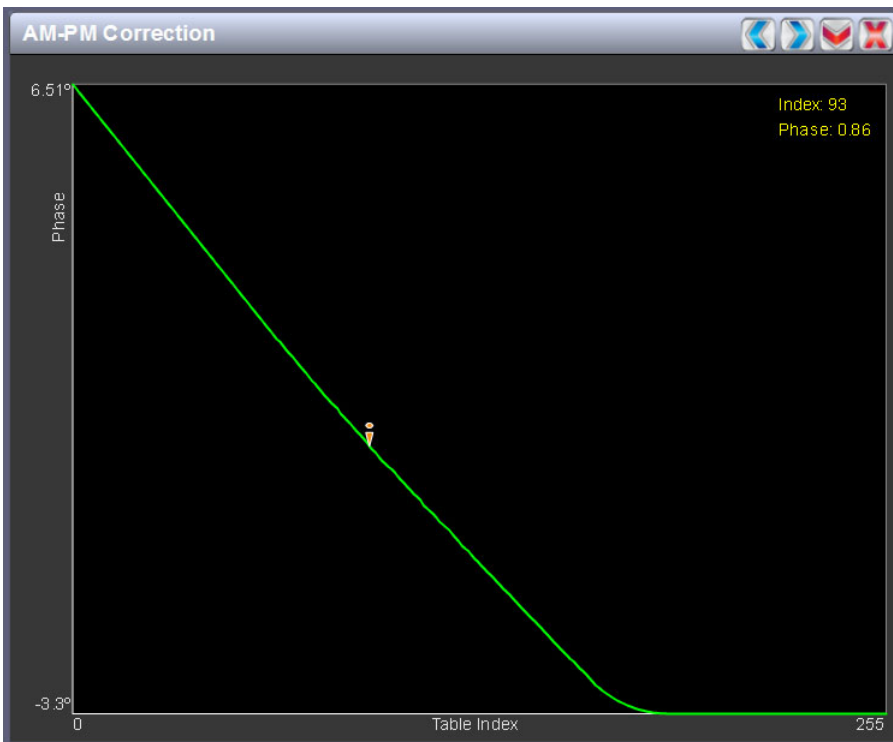
### AM-AM CORRECTION

This panel displays the amplitude correction being applied to the magnitude signal. The x-axis represents the signal amplitude and the y-axis represents the gain correction applied for a given amplitude value.

Click on the panel to display a cursor in the approximate area. The cursor position (gain and LUT index) is noted in the upper, right-hand corner of the panel. Click in other areas of the instrument to provide a coarse adjustment of the cursor position.

Use the left and right buttons as fine adjustments.

Use the up or down button to maximize (if it was minimized) or minimize (if it was maximized) the panel size.

**Figure 2.32: AM-PM Correction**

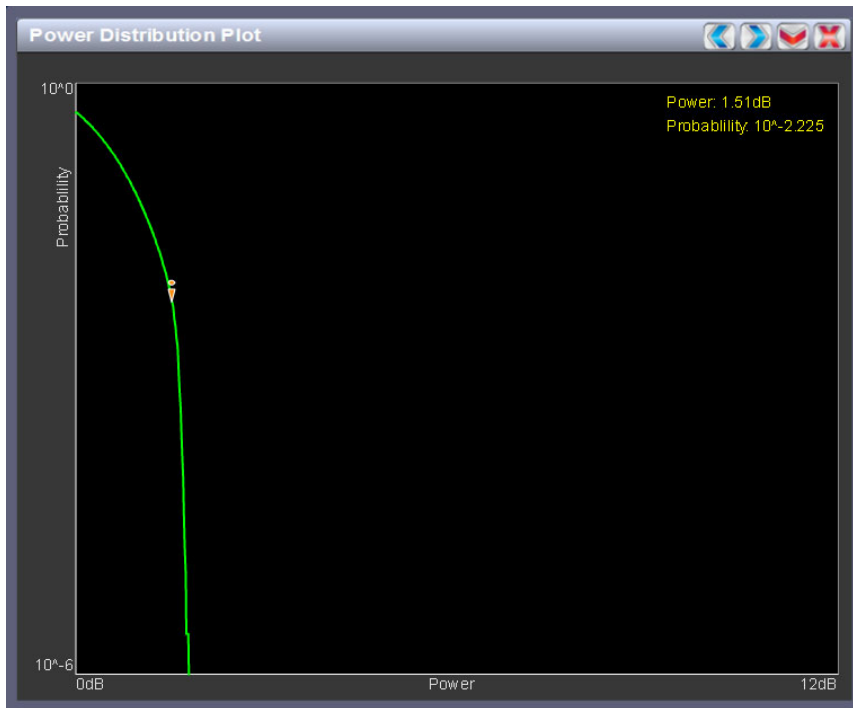
### AM-PM CORRECTION

This panel displays the phase correction being applied to the RF drive signal. The x-axis represents the signal amplitude and the y-axis represents the phase shift correction applied for a given amplitude value.

Click on the panel to display a cursor in the approximate area. The cursor position (phase and LUT index) is noted in the upper, right-hand corner of the panel. Click in other areas of the instrument to provide a coarse adjustment of the cursor position.

Use the left and right buttons as fine adjustments.

Use the up or down button to maximize (if it was minimized) or minimize (if it was maximized) the panel size.

**Figure 2.33: Power Distribution Plot**

#### POWER DISTRIBUTION

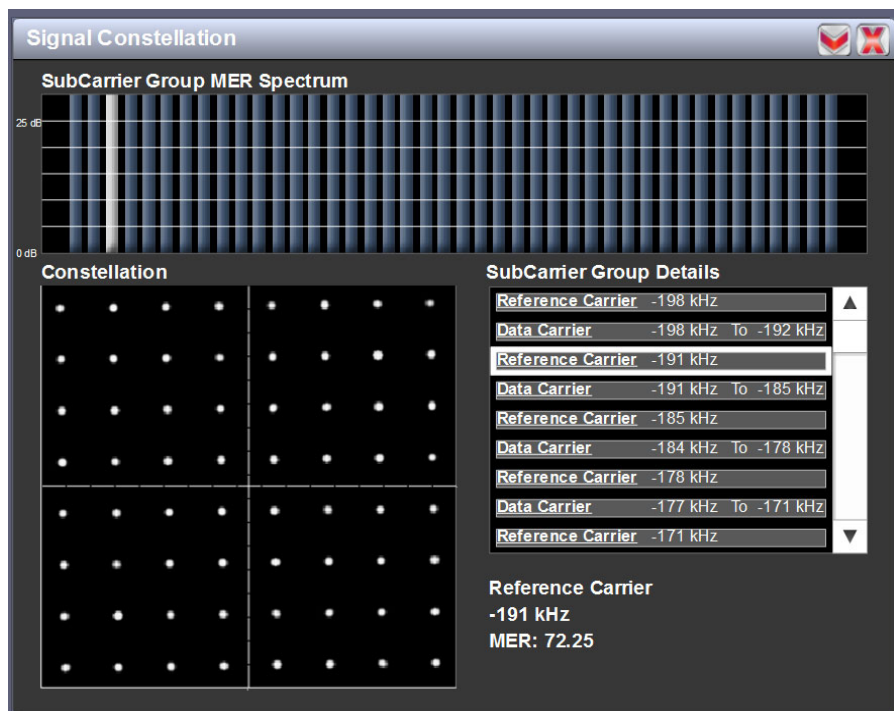
See [Figure 2.33](#). Available only when the transmitter is used with a VSHD exciter. The exciter measures the relative power levels of the signal and determines the probability of exceeding a given power level, relative to the average power. The data is plotted in the Power Distribution Plot as a CCDF (complementary cumulative distribution function). The x-axis displays the relative power level in dB, with the reference representing the average power. The average power is 0db. The y-axis displays the probability of exceeding that power level. This plot can be used to assess the distribution of a given signal, and provides an indication of the amount of peak power capability required from the transmitter in order to prevent peak clipping/distortion of the output signal.

Click the panel to display a cursor in the approximate area. The cursor position (power gain and probability index) is noted in the upper, right-hand corner of the panel. Click on other areas of this instrument panel to provide a coarse adjustment of the cursor position.

Use the left and right buttons as fine adjustments.

Use the maximize or minimize buttons as required.



**Figure 2.34: Signal Constellation**

### SIGNAL CONSTELLATION

See [Figure 2.34](#). The exciter constantly measures the transmitter signal and performs basic demodulation of the digital carriers. The Signal Constellation panel displays the phase and amplitude of the symbols being modulated within an OFDM sub-carrier as dots on a cartesian graph. There are separate screens for each sub-carrier. Typically, the dots will be grouped together around the ideal data points. When the transmitter is on, the signal constellation display is representative of the transmitter output. When the transmitter is off, the display is representative of the forward path that will be transmitted.

Sub-carrier group information is shown in the lower, right section of the screen. Displayed information includes the sub-carrier group name, the bandwidth that the selected carrier group occupies and the modulation error ratio (MER) for the selected carrier group. MER quantifies the performance of the transmitted digital signal as the ratio between the RMS power of the ideal signal and the RMS power of the received signal's error vector. A higher MER value is characteristic of a smaller error, and therefore a higher quality signal. There is a NRSC minimum requirement of a MER value of no less than 14 dB.

Use the scroll bar to select a higher or lower sub-carrier for viewing. Some sub-carriers are for timing and synchronization. Others are modulated with data/content. Use the maximize or minimize buttons as required.

## VIEWING REAL-TIME METERS

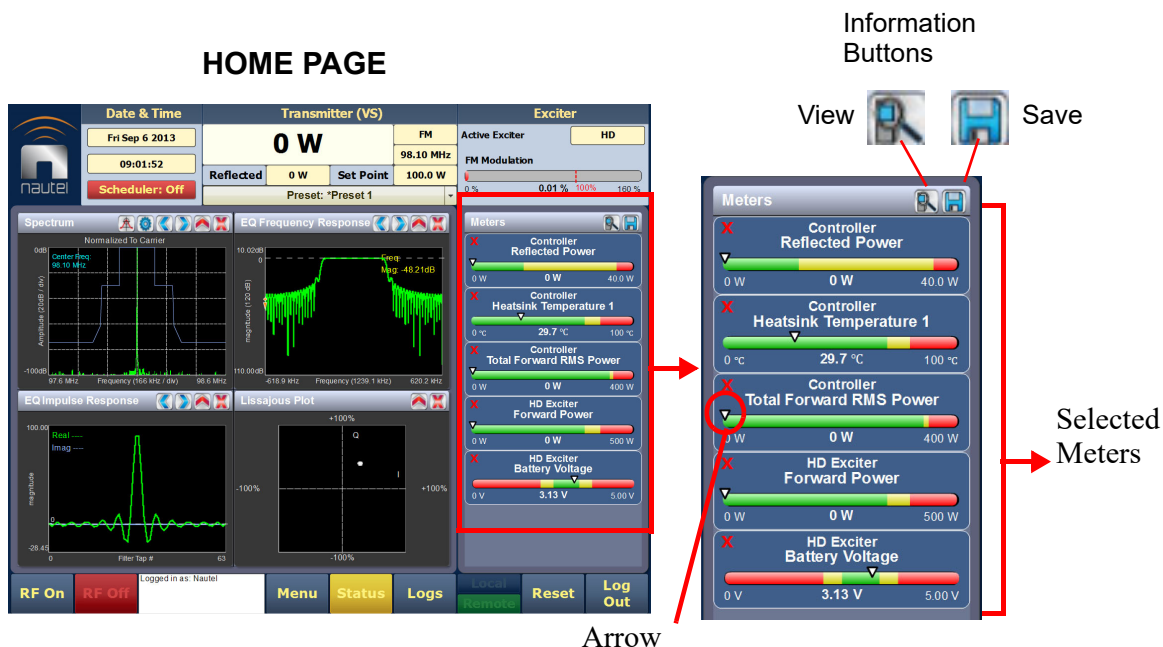
The AUI can be used to display metered parameters on the Home page (see [Figure 2.36](#)), if selected individually from the Meters List View page or saved in a meter list layout and set to default.

This section includes the following topics:

- [Describing the meter display on page 2-48](#)
- [Accessing meter information - see page 2-48](#)
- [Identifying meter information on a specific sub-device - see page 2-49](#)
- [Saving a meter list - see page 2-51](#)
- [View Meters - Using the front panel on page 2-52](#)

You can view meters using the remote AUI (see [Figure 2.35](#)) or the local front panel UI (see [View Meters - Using the front panel on page 2-52](#)).

**Figure 2.35: Meters Page**



## DESCRIBING THE METER DISPLAY

The meters displayed in the AUI represent the active meters selected for display. Each meter is a colour-coded bar with minimum and maximum values (see [Figure 2.36](#)). The current value for a meter is indicated by an arrow on the colour-coded bar, as well as a numeric value below the meter.

- A parameter value in the green section of a meter bar indicates the parameter is within the range for normal operation.
- A parameter value in the yellow section (as applicable) of a meter bar indicates the parameter is still within an operational range, but is approaching design limitations.
- A parameter value in the red section of a meter bar indicates the parameter is outside normal operating conditions.

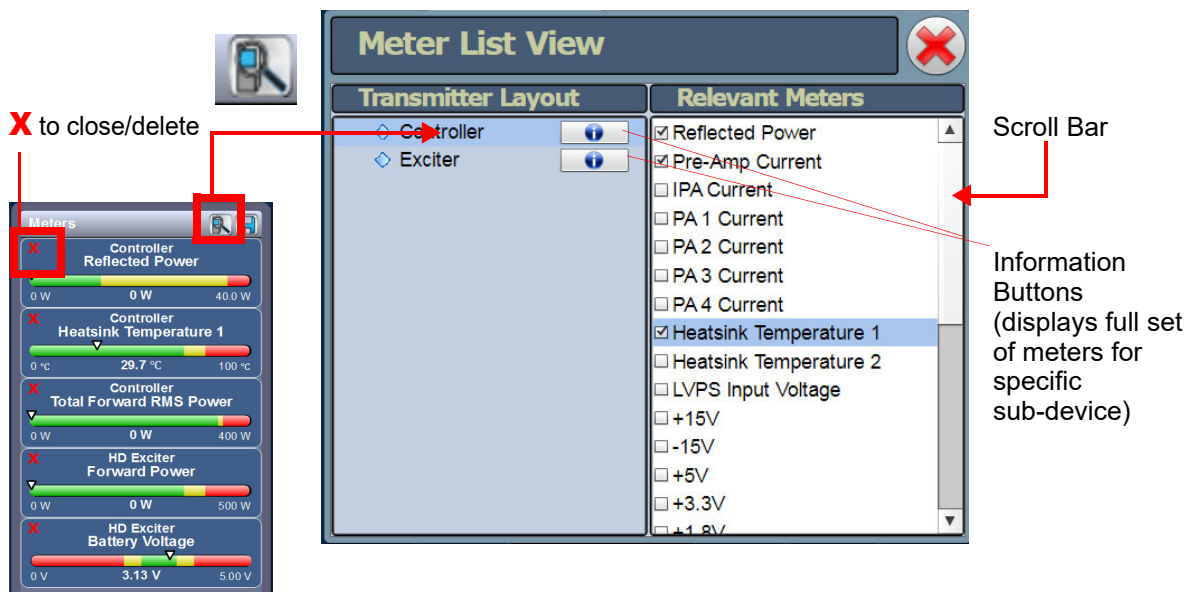
## ACCESSING METER INFORMATION

Procedures for accessing and editing information in the **Meters** section of the AUI screen:

- To delete a meter from the Home page, press **X** in the **Meters** window (see [Figure 2.35 on page 2-47](#)).
- To review all the meter options, press the meter list view shortcut button (magnifying glass) at the top of the meters panel (see [Figure 2.35 on page 2-47](#)). This will open the **Meter List View** window.

On the **Meter List View** screen users can see all relevant meters of a sub-device. Select the sub-device in question under the **Transmitter Layout** column and the **Relevant Meters** column will be populated. The desired **Meters** can now be selected.

Figure 2.36: VSHD Meter List View Window (Controller Shown)



## IDENTIFYING METER INFORMATION ON A SPECIFIC SUB-DEVICE

- Open the Meters List View window and select one of the desired transmitter sub-devices.
  - Controller
  - Exciter
  - HD Exciter (with VSHD connected)
- Under Transmitter Layout, press the information button (i) beside a device type. This will open an information window in tabular format (see [Figure 2.36](#)).

### Note:

When a meter value is updated, a blue box briefly appears around that value. Typically, updates occur every one or two seconds.

- To choose individual meters for display in the Meters window of the Home page: Select the device type name in the Transmitter Layout panel and select the checkbox next to the desired meters shown in the Relevant Meters panel (see [Figure 2.36](#)). If the Relevant Meters panel contains more than one page of information, use the scroll bar (right-side) to find the desired meter.

Figure 2.37: Detailed Sub-System Information (Controller shown)

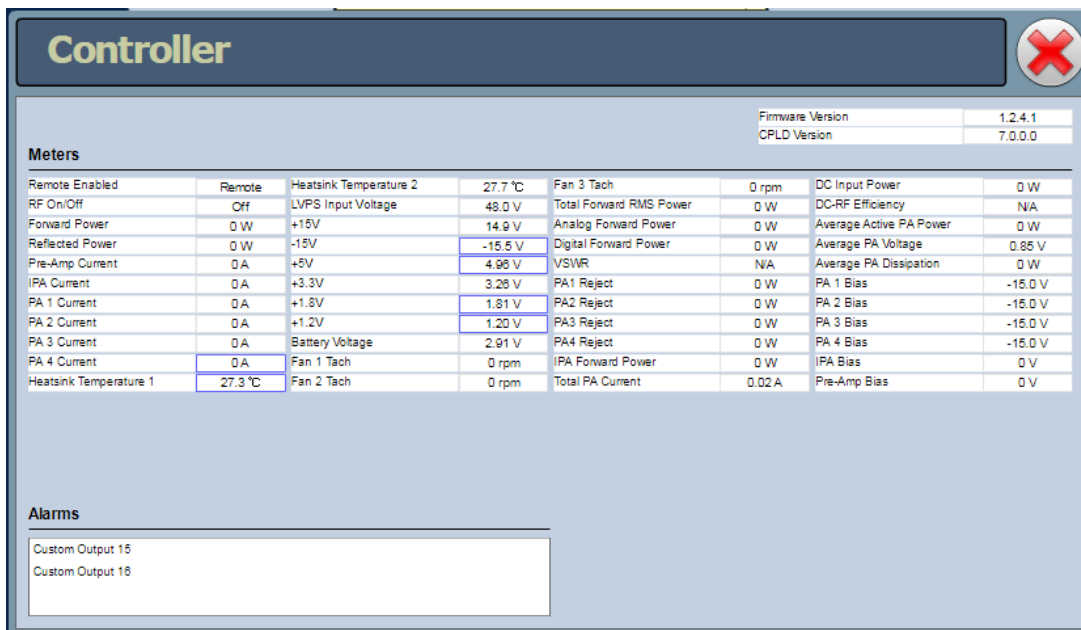


Figure 2.37 displays the status of the selected sub-system, as well as real-time meter values. The Alarms section shows any active alarms pertaining to the sub-system.

## SAVING A METER LIST



**Note:**

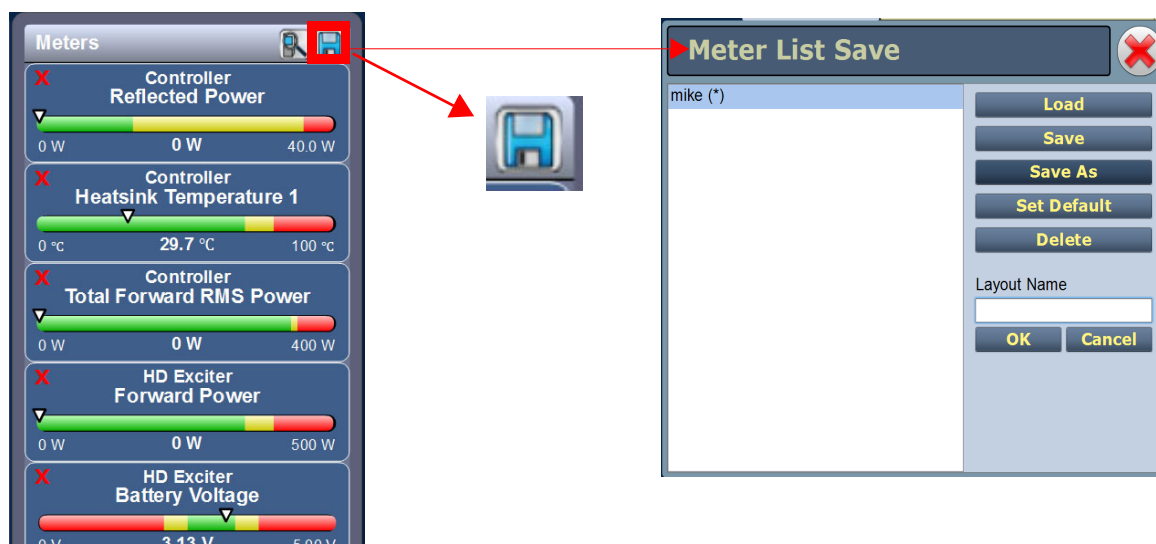
*Meter lists are associated with user accounts. Lists saved in this screen are only displayed in the current user account. Setting a list as default will define the meters that will appear when logging into the current account (or after an ac power interruption in the local AUI if this is the default user account).*

To save meter specifics for display on the Home page:

Open the Meter List Save window from the Home page using the floppy disk button (Figure 2.38).


- Press **Save As** to save the currently displayed meters. Enter a name in the **Layout Name** entry box and press **OK**.
- Press **Delete** to discard the selected meter list.
- Press **Set Default** to set the selected meter list as the default for the current user account. The \* symbol shows the default.
- Press **Save** to overwrite the selected meter list with the currently displayed meters.
- Press **Load** to display the meters saved under the currently selected meter list in the **Meters** panel on the right-hand side of the Home page.

**Figure 2.38: Meter List Save Window**

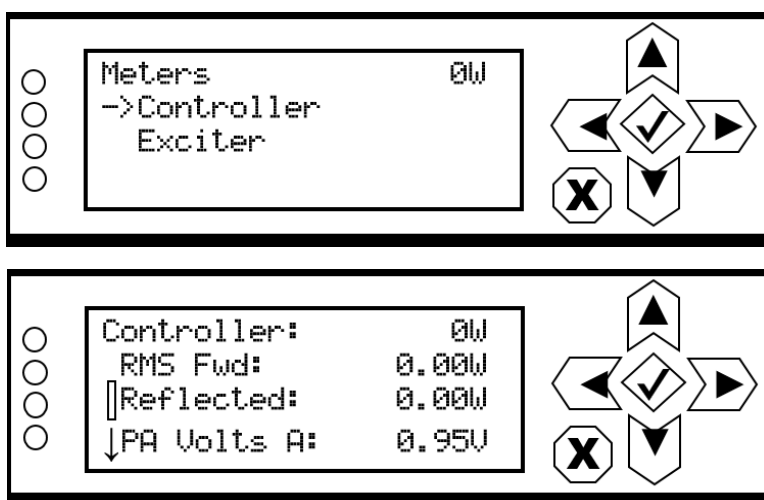


## VIEW METERS - USING THE FRONT PANEL

When you select View Status -> View Meters from the Main Menu (see [Figure 2.39](#)) you can view various metered parameters of the VS2.5. These parameters are displayed as a list on the View Meters -> Controller or Exciter screens.

 **Note:**  
*This screen is for viewing purposes only and does not offer the same level of analytical features as the AUP's Meter List View page (see [Figure 2.36](#) on page 2-49).*

**Figure 2.39: View Meters Screen**



Use the up and down buttons to select Controller or Exciter and then scroll through the appropriate list of metered parameters shown below:

## Controller Meters:

RMS Forward	+5V A	Fan 7
Reflected	+3.3V	VSWR
PA Volts A	+1.8V	DC Power In
PA1 Curr	+1.2V	DC-RF Eff
PA2 Curr	Battery	Avg PA Diss
PA3 Curr	Fan 1	PA1 Bias
PA4 Curr	Fan 2	PA2 Bias
Heatsink Temp 1	Fan 3	PA3 Bias
Heatsink Temp 2	Fan 4	PA4 Bias
+48V	Fan 5	IPA Bias
+15V	Fan 6	IPA Fwd
-15V		

## Exciter Meters:

Fwd	-15V	Dig 2 R
Refl	+5V A	MPX SCA**
PA VSWR	+5V B	MPX RMS***
PA V	+3.3V	AGC Lim
PA Curr	+1.8V	MPX Lim
PA Bias	+1.2V	DAC Gain
PA Diss	Battery	Fwd Att
Preamp V	Peak Mod	Rev Att
Preamp I	Bal L	delta 10 MHz
Preamp Bias	Bal R	Rev Gain
Fan V	MPX	Mask delta
Fan	Int SCA 1	Tilt
PA Temp	Int SCA 2	Data MER
PWB Temp	Dig 1 L	Ref MER
LVPS	Dig 1 R	LSB MP1
+15V	Dig 2 L	USB MP1

\*\* Note: MPX SCA meter displays "N/A" if MPX is the main audio source.

\*\*\* Note: MPX RMS is displayed as a percentage (%). Convert to dBr as follows:

$$MPX\ RMS\ in\ dBr = 20\ log\ 10\left( MPX\ RMS\ in\ \% * \frac{75\ kHz}{100\%} * \frac{\sqrt{2}}{19\ kHz} \right)$$



## MANAGING PRESETS

This section includes the following subjects:

- [Managing Presets - Using the AUI](#)
- [Loading presets using the AUI - see page 2-55](#)
- [Activating presets using the AUI - see page 2-55](#)
- [Editing or creating presets using the AUI - see page 2-56](#)
- [Managing Presets - Using the front panel - see page 2-75](#)

Presets contain operational data (power, frequency, mode, program inputs) for the transmitter. You can create and manage presets using the remote AUI (see [Managing Presets - Using the AUI](#)) or the front panel UI (see [Managing Presets - Using the front panel on page 2-75](#)).

### MANAGING PRESETS - USING THE AUI

The Presets page (see [Figure 2.40](#)) allows you to create up to 63 operating presets or edit existing presets. To view the Presets page, select Presets from the Menu options. Many preset settings available on the remote AUI are also available on the front panel UI. In this case, if you change a preset setting on the remote AUI, it will also be reflected on the front panel UI, and vice versa.

**Figure 2.40: Presets page (General tab shown)**

The screenshot shows the Nautel transmitter web interface. At the top, there are sections for Date & Time (Thu Oct 31 2013, 09:29:37), Transmitter (0 W, 96.70 MHz, FM, Reflected 0 W, Set Point 32.0 W, Preset: \*Preset 3), and Exciter (Active Exciter Internal, FM Modulation 55.6%). Below this is the 'Presets: Current Settings' window with a close button. The 'General' tab is selected, showing a table of settings:

Field	Value	Unit
Preset Name	Current Settings	
Output Power	32.00	W
Frequency	96.70	MHz
Mode	FM	

At the bottom of the interface, there are buttons for RF On, RF Off, Menu, Status, Logs, Local, Remote, Reset, and Log Out. The user is logged in as 'Nautel'.

## LOADING PRESETS USING THE AUI

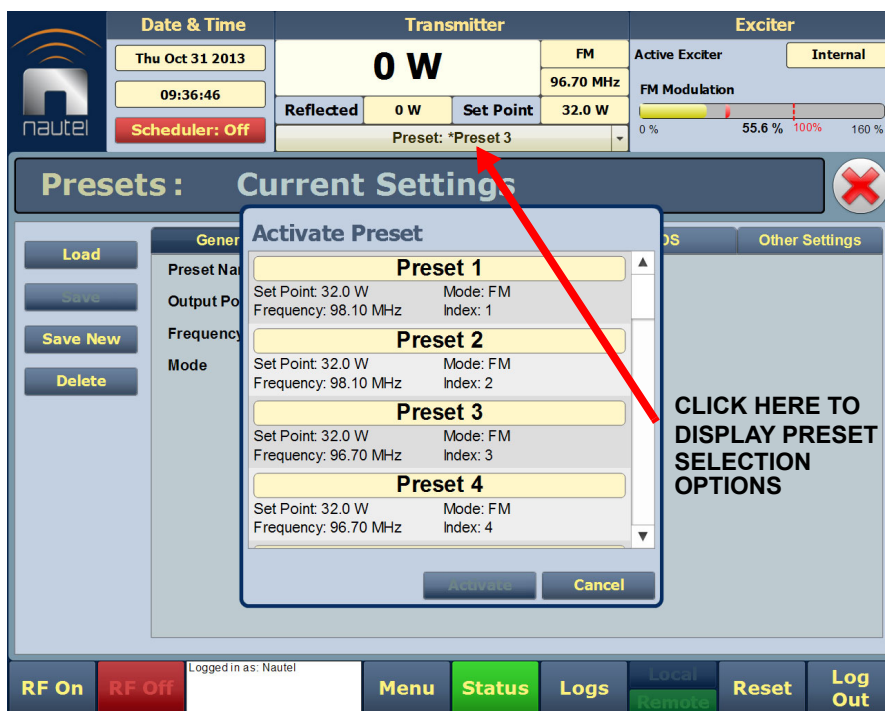
When first entering the Presets page, the current “active” preset is displayed (see [Figure 2.40 on page 2-54](#)). If the current preset is not the desired one, use the **Load** button on the left-side of the AUI to call up a window containing a list of available presets.

Select the desired preset and press the **OK** button to view or enable editing of the preset. Press the **Delete** button to delete the selected preset. Users cannot delete the current "active" (operational) preset or any preset that is referenced in the **Remote I/O** menu as either a remote input or output. Those links in the **Remote I/O** menu must be deleted before the associated preset can be deleted. Press **Cancel** to return to the Presets page.

## ACTIVATING PRESETS USING THE AUI

In the Transmitter block in the AUI's top banner, press the bar that contains the active preset name and the drop-down arrow (see [Figure 2.41](#)). The **Activate Preset** window will appear, which contains a list of all preset options. Press and highlight the desired preset and press the **Activate** button to enable the preset as the transmitter's active preset. Press the **Cancel** button to close this window.

**Figure 2.41: Activating Presets**



---

## EDITING OR CREATING PRESETS USING THE AUI

When a presets page is opened from the main menu, the **Current Settings** of the transmitter are displayed. They define the current operational state of the transmitter. **Current Settings** can be edited and then immediately activated by pressing the **Save** button.

To edit a saved preset, you must load that preset from the Presets page (see [Loading presets using the AUI on page 2-55](#)). If the edited preset was active before it was edited, saving the preset will update the preset, but the **Current Settings** will not change. To update the operation of the transmitter, re-activate the preset through the top banner (see [Activating presets using the AUI on page 2-55](#)).

In the top banner (see [Figure 2.41 on page 2-55](#)), an asterisk (\*) appears next to the preset name when the **Current Settings** have changed since the last preset was loaded. **Current Settings** are not saved through an ac power cycle; when the transmitter recovers from an ac power loss, it loads the preset that was last activated.

On the Presets page, an asterisk (\*) appears next to the preset name in the header when there are unsaved changes to the preset.

When changes are complete, press the **Save** button and then press the **Save Preset** window's **Save** button to enable the changes. If you are creating a new preset, you can also enter a new name (e.g., Preset 4 - IBOC) in the preset window before clicking the **Save** or **Save New** button.

Parameters that can be edited are discussed in detail below.

To remove a preset, select it and press the **Delete** button.

To ignore any changes, press **Cancel** to return to the Presets page.

General tab: (see [Figure 2.42](#))

- **Preset Name:** This field identifies the current preset settings. Users must load a preset to directly edit this field (see [Activating presets using the AUI on page 2-55](#)).
- **Output Power:** Set the output power level (in kW). Output power limits are a function of the transmitter mode of operation (see Table 1-1 of the Pre-Installation Manual for RF output power ratings for this transmitter)
- **Frequency:** Set value. Valid frequencies are between 87.00 and 108.00 MHz.

- **Mode:** Set the overall transmission mode. Available options are:
  - **FM:** an analogue only mode, transmits a carrier, frequency modulated with audio.
  - **HD:** all digital mode; this mode transmits the upper and lower digital sidebands of OFDM IBOC carriers. HD transmitter is typically high-level combined (coupler or spatial) with a paired FM only transmitter. See page 2-57 for additional calibration settings. This mode requires additional hardware.
  - **FM+HD:** also known as hybrid/simulcast or low-level combined, this mode transmits the analog carrier (FM modulated) and the upper and lower digital sidebands of OFDM IBOC carriers. See page 2-57 for additional calibration settings. This mode requires additional hardware.
  - **DRM+:** transmits a DRM OFDM signal using the I/Q stream from a DRM modulator connected to the desired AES input. See page 2-57 for additional calibration settings. This mode requires additional hardware.

**Note:**

Settings on the Presets tabs are shown/hidden based on the chosen settings. Not all settings are available in all modes.

**MODE - ADDITIONAL CALIBRATION SETTINGS:**

- **IBOC Injection (Lower):** for FM+HD and HD modes, enter value, in dB, between -20 and -10 dB for the IBOC injection level of the lower sideband of digital carriers. This value determines the relationship between the digital carriers power and the analog carrier power. Example: -20 dB indicates that the total RMS power of the digital carriers will be 1/100 of the total RMS power of the analog carrier. -10 dB indicates that the total RMS power of the digital carriers will be 1/10 of the total RMS power of the analog carrier.
- **IBOC Injection (Upper):** for FM+HD and HD modes, enter value, in dB, between -20 and -10 dB for the IBOC injection level of the lower sideband of digital carriers. This value determines the relationship between the digital carriers power and the analog carrier power. Example: -20 dB indicates that the total RMS power of the digital carriers will be 1/100 of the total RMS power of the analog carrier. -10 dB indicates that the total RMS power of the digital carriers will be 1/10 of the total RMS power of the analog carrier.

**Note:**

*The actual digital sideband power is 3 dB less than that indicated in the upper or lower IBOC Injection fields; i.e. if -20 dBc is entered in the upper and lower IBOC Injection fields, the upper and lower digital sideband power levels are actually -23 dBc; this way, when added, the resultant total digital power level is -20 dBc.*

*For symmetrical sideband transmission: if -14 dBc IBOC Injection level is desired (total digital power of upper + lower sidebands is 4% of analog carrier power), set the upper and lower IBOC Injection levels to -14 dBc.*

*For asymmetrical sideband transmission, consider that the actual sideband power level is 3 dB less than that shown. For example, if the upper digital sideband IBOC Injection level is entered as -14 dBc, the actual power level will be -17 dBc. This is equally true for the lower digital sideband.*

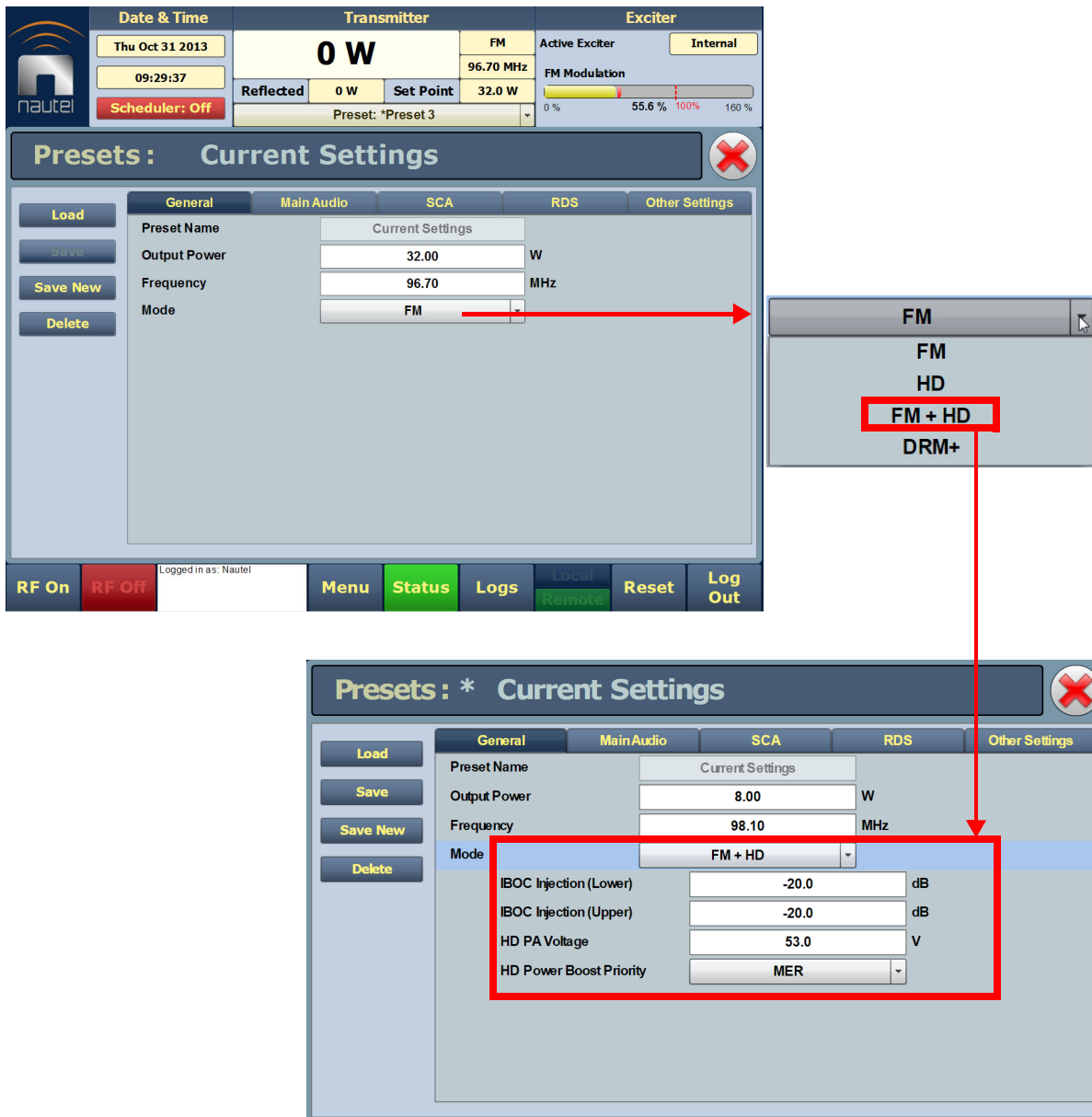
- **HD PA Volts:** for FM+HD, HD and DRM+ modes, enter value, in volts, between 25.0 V and 53.0 V. This value sets the drain voltage applied to the PAs in the RF power modules, from their associated power supplies. This value affects IBOC/DRM+ performance. Larger values result in an improved spectrum, but decreased efficiency. Conversely, smaller values result in improved efficiency, but degrade the spectrum. Typical values are between 35 V and 50 V, and depend on many variables such as power level, frequency and injection level.

**Note:**

*The preferred option to maximize IBOC performance is by using the HD Optimizer feature (see “[Spectrum/Efficiency Optimizer](#)” on page 2-104. In this case, leave PA Volts setting at its default value (53.0 V).*

- **HD Power Boost Priority:** for FM+HD mode only, select either MER (modulation error ratio or signal quality; default setting) or Efficiency.
  - Selecting Efficiency maximizes the aggressiveness of Nautel’s HD PowerBoost process, an advanced peak-to-average power ratio reduction algorithm that prioritizes efficiency and power capability when reducing the peak-to-average power ratio, while ensuring that the MER of the transmitted HD signal meets transmission requirements.
  - Selecting MER minimizes the aggressiveness of the HD PowerBoost function and makes maximizing MER the priority. Transmitter efficiency and power capability will be reduced as a result.

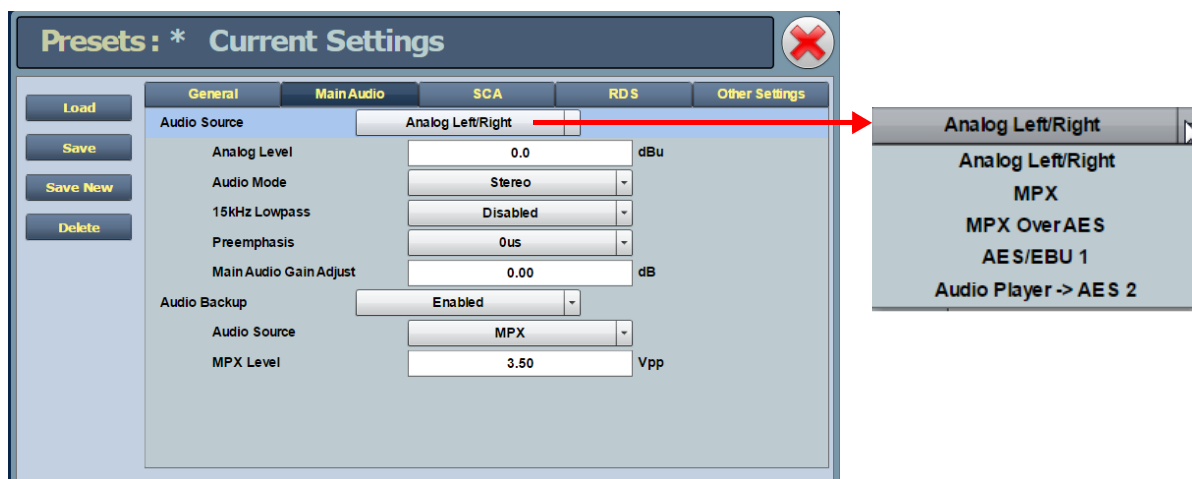
Figure 2.42: Presets - General Tab (FM and FM+HD Mode shown)



Main Audio tab: (see [Figure 2.43](#))

- Audio Source: Connects the appropriate exciter input for use. Available options are:
  - Analog Left/Right: this source allows for further configuration via Analog Level, Audio Mode (Mono L+R, Mono L, Mono R, Stereo), 15kHz Lowpass, Preemphasis, Main Audio Gain Adjust settings. See page [2-61](#) for additional configuration information.
  - MPX: this source allows for further configuration via the MPX Level setting. See page [2-61](#) for additional configuration information.
  - MPX Over AES: this source allows for further configuration via the Digital Level setting. See page [2-61](#) for additional configuration information.
  - AES/EBU 1: this source allows for further configuration via Digital Level, Audio Mode (Mono L+R, Mono L, Mono R, Stereo), 15kHz Lowpass, Preemphasis, Main Audio Gain Adjust settings. See page [2-61](#) for additional configuration information.
  - Audio Player -> AES 2: this source allows for further configuration via Digital Level, Audio Mode (Mono L+R, Mono L, Mono R, Stereo), 15kHz Lowpass, Preemphasis, Main Audio Gain Adjust settings. See page [2-61](#) for additional configuration information

**Figure 2.43: Presets - Main Audio Tab**



---

**MAIN AUDIO - ADDITIONAL CONFIGURATION SETTINGS:**

- Audio Player Source: applies to Audio Player -> AES 2 source only; select the desired audio playlist.
- Analog Level: applies to Analog Left/Right source only; enter value between -12 and +12 dBu, which represents the input voltage level that yields 100% modulation (Default is 0.0 dBu).
- Digital Level: applies to MPX Over AES, AES/EBU 1 and Audio Player -> AES 2 sources only; enter value between -25.5 and 0 dBFS, with a typical setting of -4 dBFS (100% modulation value).
- MPX Level: applies to MPX source only. Set this parameter level in Vpp (typically 3.5 Vpp - 100% modulation value). The allowable range for this setting is between 1-5 Vpp.
- Audio Mode: applies to Analog Left/Right, AES/EBU 1 and Audio Player -> AES 2 sources only; select Mono L, Mono R, Mono L+R or Stereo (selecting Stereo applies a 19 kHz pilot).
- 15kHz Lowpass Filter: applies to Analog Left/Right, AES/EBU 1 and Audio Player -> AES 2 audio sources only; select Enabled (applies 15 kHz low-pass filter to audio input) or Disabled.
- Preemphasis: applies to Analog Left/Right, AES/EBU 1 and Audio Player -> AES 2 audio sources only; select 0 us, 25 us, 50 us or 75 us.
- Main Audio Gain Adjust: applies to Analog Left/Right, AES/EBU 1 and Audio Player -> AES 2 sources only; allowable range is -20 to 10 dB. This configuration setting will increase the incoming signal level and yield a proportional increase in % modulation.
- Audio Backup: When you set **Audio Backup** to **Enabled**, you can select a backup **Audio Source** and edit various parameters for the backup audio similarly to the main audio described above. The backup audio source, if enabled and present, will replace the main audio source if the main audio level is less than its user-determined trip threshold (see [“User Settings - Front Panel UI”](#) on page 2-150). The main audio source will be restored as the active source if it returns and is present for at least one second.

**Note:**

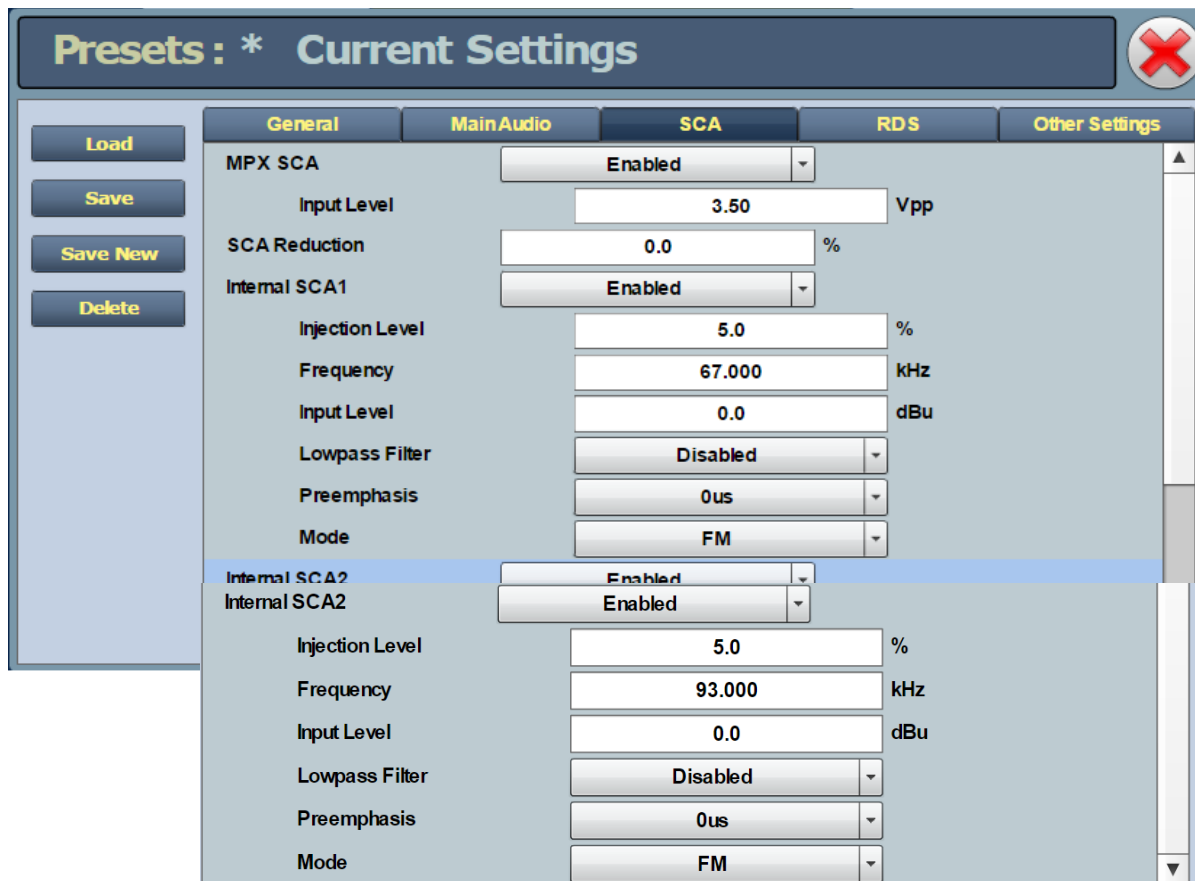
*AES2 may not be used as a backup source for AES1 when the internal exciter is used.*



SCA tab: (see [Figure 2.44](#))

- **MPX SCA:** Connector (J7:A for SCA1, J7:B for SCA2) for use with an externally generated SCA; select **Enabled** or **Disabled**. When enabled, all the selections listed below are active.
  - **Input Level:** signal level that represents 10% modulation. Enter a value between 1 and 5 V p-p (typically 3.50 Vpp).
- **SCA Reduction:** Attenuation applied to the SCA input; set between 0 and 20% (used to reduce the modulation level of the main audio when SCAs are enabled; typically, for every 2% of SCA modulation, the main audio modulation must be reduced by 1%).
- **Internal SCA1/2:** Enable or disable the appropriate internal SCA (**SCA1** or **SCA2**). When enabled, the settings listed below are active for the associated SCA signal (1 or 2).
  - **SCA1 or SCA2 Injection Level:** enter value between 0 and 20% (typically 10%); this level is added to the composite baseband signal.
  - **SCA1 or SCA2 Frequency:** enter value between 20 and 100 kHz (typically set to 67 kHz or 92 kHz).
  - **SCA1 or SCA 2 Input Level:** enter value between -12 and +12 dBu, which represents the input voltage level that yields 10% modulation (typically 0.0 dBu).
  - **SCA1 or SCA2 Lowpass Filter:** select **Enabled** (applies 7.5 kHz low-pass filter to audio input) or **Disabled**.
  - **SCA1 or SCA2 Preemphasis:** select 0 us, 50 us, 75 us or 150 us.
  - **SCA1 or SCA2 Mode:** select **FM** (frequency modulated sub-carrier, typical) or **DSB-SC** (double side band suppressed carrier).

Figure 2.44: Presets - SCA Tab (scroll to see all options)





**Note:** Check your local broadcast regulatory body's guidelines for allowable modulation depth with SCAs or RDS enabled.

RDS tab: (see [Figure 2.45 on page 2-67](#))


For RDS operation, an external unit or software can send data to the exciter, serially or over IP. The exciter generates the RBDS/RDS carrier and injects the data; externally generated, or alternatively, the Presets page offer a means to configure internally generated data.

Refer to [“RDS Remote Protocol” on page 2-68](#) for information on using the ASCII protocol to remotely configure RDS settings and to observe the strings supported by Nautel.


 *Note:*  
The UECP protocol is fully supported.

 *Note:*  
The differences between RDS (European) and RBDS (North American) are not part of this manual. Presets created using the VS2.5 are compatible with either type.


- **RDS:** select Enabled or Disabled (default is Disabled). When enabled, all of the selections below are active and the View RDS Demod option appears on the View Status menu (see [“View RDS Demod - Front Panel UI.” on page 2-29](#)), which allows monitoring of the demodulated RDS content applied to internally generated RDS carrier:

 *Note:*  
When using the internal data source, you must correctly enter all RDS fields - specifically PI Code or PS Name - to ensure proper reception of RDS information.

- **Data Source:** select Internal, ASCII over Serial, UECP over Serial, ASCII over IP, or UECP over IP.

 *Note:*  
For ASCII over IP data or UECP over IP data, send RDS information to the IP address of the VS2.5, port 7005.

- **RDS Local Echo** (displayed only when Data Source is ASCII over Serial). Select Enabled or Disabled (default is Disabled). When Enabled, the exciter RDS port transceiver will echo all inputs and controls received back to the terminal.
- **Injection Level:** enter value between 0 and 10% (default is 5%). This level is added to the composite baseband signal.

 *Note:*  
Check your local broadcast regulatory body’s guidelines for allowable modulation depth with SCAs or RDS enabled.

- **Phase:** enter value in degrees between 0 and 360 (default is 0.0 degrees).

- **Baud Rate** (displayed only when Data Source is ASCII over Serial or UECP over Serial): select 150, 300, 600, 1200, 2400, 4800, 9600, 19200, 38400, 57600 or 115,200 bps (default is 19200). Does not apply to the Internal data source.

The Presets -> RDS page selections below Baud Rate apply only to the Internal data source.

- **PI Code** (hex) (Program Identification code): enter four hex digits that represent the station call sign (e.g., PI= 1AE5); this unique code is used to identify a broadcast station. Each station gets assigned a specific code with a country identifying prefix. In the USA the code is determined by applying a formula to the station's call sign (see [www.nrcstandards.org](http://www.nrcstandards.org)). In Canada the code is determined using the Spectrum Management and Telecommunications tool found at [www.ic.gc.ca](http://www.ic.gc.ca). Contact your local broadcast regulatory body for details on determining your unique PI Code.
- **PS Name** (programme service name): this is simply a maximum 8-character "tagline" static display that represents the call letters or station identity name. Most RDS capable receivers display this information and, if the station is stored in the receiver's presets, will cache this information with the frequency and other details associated with that preset. Default is blank.
- **Scrolling Enable/Speed**: determines the scrolling speed of the Scrolling PS Name. Select Off (disabled), Slow (transitions every 10 s) or Fast (transitions every 3 s). Default is Off.
- **Scrolling PS Name**: if used, enter up to 64 characters for the PS name that will scroll (if enabled) at the speed selected in the Scrolling Enable/Speed field. Information is displayed on the receiver based on transmitter configuration; however, is limited to 8 characters maximum. Default is blank.
- **Scrolling Type**: select the type of scrolling to be used by the receiver - Word or Character. Word scrolling displays and transitions a maximum of 8 characters of the Scrolling PS Name at a time. Character scrolling still displays a maximum of 8 characters; however, transitions by one character of the Scrolling PS Name at a time. In both cases, transitions occur at the speed defined by the Scrolling Enable/Speed selection (Slow or Fast). The default selection is Word.



*Note:*

*Words are defined by the spaces in the Scrolling PS Name. Words that exceed 8 characters will scroll each character until the entire word is displayed, then continue with the next word.*

- **Radio Text**: Most RDS radios can receive short messages that may include information about the presenter, station or program you are listening to (e.g., a web address for the station). You can enter radio text up to 64 characters in length. Information is

- displayed on the receiver based on the receiver configuration and capability (e.g., maximum number of characters on the screen). Default is blank.
- **PTY**: this coding of up to 32 (0 to 31) pre-defined programme types allows users to find similar programming by genre. Default is 0: NONE/NONE.
  - **PTYN** (programme type name): this field can be used for detailed description of the PTY by 8 digits. Example: if the PTY is 4 (Sport) a PTYN like “Football” could be transmitted. The PTYN is intended for displaying additional information only and cannot be used for automatic station tuning like the PTY. The PTYN is optional. Default is blank.
  - **Music/Speech**: select Music or Speech. Default is Speech.
  - **Traffic Info**: select None, TA (Traffic Announcement), TP (Traffic Programme) or TA+TP. The receiver can often be set to pay special attention to this flag and, for example, stop the tape/pause the CD or re-tune to receive a traffic bulletin. The TP flag is used (set to 1) to allow the user to find only those stations that regularly broadcast traffic bulletins whereas the TA flag is used (set to 1) to signal an actual traffic bulletin in progress. These flags are set to 0 if they are not being used for traffic information. Default is None.
  - **Alt. Frequencies**: select None or 1 through 25. This allows a receiver to re-tune to a different frequency providing the same station information (i.e., using translators or repeaters) when the first signal becomes too weak. This is often utilized in car stereo systems. Default is None.
  - **Artificial Head** (bit 1 of DI, see NOTE below): select Enabled or Disabled. This selection is a decoder identification operating mode flag. Default is Disabled.
  - **Compression Flag** (bit 2 of DI, see NOTE below): select Enabled or Disabled. This selection is a decoder identification operating mode flag. Default is Disabled.
  - **Dynamic PTY** (bit 3 of DI, see NOTE below): select Dynamic or Static. This selection is a decoder identification operating mode flag. Default is Static.
  - **Stereo** (bit 0 of DI, see NOTE below): select Stereo or Mono. This selection is a decoder identification operating mode flag. Default is Mono.

**Note:**

*Artificial Head, Compression Flag, Dynamic PTY and Stereo are part of the DI (Decoder Information) data (see UI editing screens on [Figure 2.67 on page 2-88](#)). RDS Data is provided as a single-digit hex input between 0 and F, that encodes the flags for the four settings as a 4-bit code. For example: hex number 3 is bit-represented by 0011, from bit 3 on the left to bit 0 on the right. This number is decoded to mean Stereo = Yes/Stereo (bit 0=1), Artificial Head = Yes/Enabled (bit 1=1), Compression = No/Disabled (bit 2=0) and Dynamic PTY = No/Static (bit 3=0).*

Figure 2.45: Presets - RDS Tab (scroll to see all options)

**Presets : \* Current Settings**
✕

Load

Save

Save New

Delete

General	Main Audio	SCA	RDS	Other Settings
RDS		Enabled ▾		
Data Source	ASCII over Serial ▾			
RDS Local Echo	Disabled ▾			
Injection Level	0.0	%		
Phase	0.0	°		
Baud Rate	19200bps ▾			
PI Code (hex)	0x0000			
PS Name				
Scrolling Enable/Speed	Off ▾			
Scrolling PS Name				
Scrolling Type	Word ▾			
Radio Text				
PTY	0: NONE/NONE ▾			
PTYN				
Music/Speech	Speech ▾			
Traffic Info	None ▾			
Alt. Frequencies	None ▾			
Artificial Head	Disabled ▾			
Compression Flag	Disabled ▾			
Dynamic PTY	Static ▾			
Stereo	Mono ▾			

---

**RDS REMOTE PROTOCOL.** The following information is intended to assist users with remote RDS settings using the ASCII protocol.

**Assigning Settings:** To assign a value to a setting, send the setting name, the equal sign (=) and the desired value. If the setting is valid, the exciter responds “OK”. If the setting is invalid, the exciter responds “NO”.

```
Examples: PI=1248 //set the PI code to 0x1248
          OK      // exciter responds with OK
          TA=2    // set the traffic announcement to 2 (bad command; only values 0 or 1
allowed)
          NO      // exciter responds with NO
```

**Querying Settings:** To determine the current value of a setting, type the setting name with a question mark (?) instead of an equal sign (=).

```
Examples: PI?      //query the current PI code
          1248     // exciter responds with “1248”, the current PI code
```

### **Other Considerations:**

#### Initial Values and Preset Changes

On startup, or when the RDS settings in the active preset differ from the last ones loaded, the preset’s initial RDS settings (PS, PI, PTY, PTYN, RT, AF, etc.) will be loaded. If there is an active data source (UECP or ASCII via serial or IP), these settings may be updated externally.

The RDS settings from the preset will only be loaded again if they change, otherwise the working set from the external data source will continue to be used. This allows unrelated preset changes to adjust other settings without affecting RDS functionality.


#### Real Time Clock

The exciter/control PWB has a battery-backed real-time clock that keeps track of the time and date. It is possible the exciter’s RDS generator could broadcast the incorrect time and date if this is not set correctly, so the broadcast of time must be enabled via ASCII or UECP each time the system is powered up. Until it is enabled, the time will not be broadcast again after a power failure.

TCP Usage

Use TCP port 7005. This is not user configurable. To use RDS over IP, the connection must be opened before each command.

**List of Settings:** [Table 2.4](#) lists the RDS settings supported by Nautel, including descriptions and examples.

	<p><i>Note:</i> Remote setting of the RDS baud rate is not supported.</p>
---	---

**Table 2.4: Supported ASCII Settings for RDS**

Setting	Name	Description/Example
PI=	Program Identification	Four hex digits representing the station call sign. Consult the RDS/RBDS specification for more information.  Example: PI=1AE5
PS=	Program Service	Maximum 8-character ASCII “tagline” string describing the radio station.  Example: PS=Q104-FM
PTY=	Program TYPe	Number, from 0 to 31, describing the station format.  Example: PTY=24
PTYN=	Program TYPe Name	8-character ASCII string, also describing the station format.  Example: PTYN=JAZZ24-7
TP=	Traffic Program	Set to 1 if the current program sometimes carries traffic information, otherwise set to 0.  Example: TP=1
TA=	Traffic Announcement	Set to 1 if the current program is currently broadcasting a traffic announcement, otherwise set to 0.  Example: TA=0 NOTE: Timeout of the TA flag is not implemented, so the RDS data source should ensure this flag is properly cleared.



**Table 2.4: Supported ASCII Settings for RDS**

Setting	Name	Description/Example
AF1= ... AF25=	Alternative Frequency	If the station broadcasts on more than one frequency using translators or repeaters, these are typically set to each of the frequencies used in the broadcast network.  Sample calculation for 98.5 MHz: $(98.5-87.8) \times 10 = 107$  Example: AF1=107 NOTE: there is no method to disable AFs in this protocol.
DI=	Decoder Information	Single hex digit, range 0-9 and A-F (case insensitive) that encodes the flags Stereo(1)/Mono(0) - bit 0; Artificial Head (Yes=1, No=0) - Bit 1; Compression (Yes=1, No=0) - Bit 2; and Dynamic (Yes=1, No=0) - Bit 3  Example: DI=3 (Stereo, Artificial Head=Yes, Compression=No, Dynamic=No)
MS=	Music/Speech	Typically set to 1 if the station broadcasts music, otherwise set to 0.  Example: MS=1
TEXT=	Radio Text	Accepts a 1 through 64 character ASCII string, displayed on receivers that support RDS radio text.  Example: TEXT=Tears for Fears - Shout (1985)
ECHO=	Echo on/off	If set to 1, the RDS encoder will echo back characters that are sent to it. If set to 0, the encoder will only send responses.  Example: ECHO=1
DATE=	Current UTC date	Format is strictly YYYY-MM-DD. Sets the current UTC date for 4A date/time broadcasts. This is a non-volatile setting.  Example: DATE=2016-04-04
TIME=	Current UTC time	Format is strictly HH:MM:SS, 24-hour format. Sets the current UTC time for 4A date/time broadcasts. This is a non-volatile setting.  Example: TIME=17:23:05

**Table 2.4: Supported ASCII Settings for RDS**

Setting	Name	Description/Example
UTC=	UTC time zone offset	Range is 0 to 24, 32 to 56. Sets the current time zone. To calculate this value, multiply the time offset by 2 and add 32 if the time offset is negative. For Newfoundland (UTC-3.5), $3.5 \times 2 = 7$ , and add 32 (since the time zone is negative) to yield 39. This is a non-volatile setting.  Example: UTC=39
CT=	4A date/time enable	If set to 1, the exciter will broadcast a 4A RDS packet on the edge of every minute with the currently set UTC time/date. This is a volatile setting.  Example: CT=1
DPS=	Dynamic Program Service (scrolling command)	64-character ASCII string typically describing the radio station.  Example: DPS=Q104-FM The Home of Rock N Roll
DPSR=	Dynamic Program Service Rate (scrolling command)	Number, from 0 to 2, describing the scrolling rate. 0 is off (default); the PS= command is displayed when DPSR=0 is used. 1 is slow; the DPS string will scroll at a rate of approximately 10 s. 2 is fast; the DPS string will scroll at a rate of approximately 3 s.  Example: DPSR=2
DPSM=	Dynamic Program Service Mode (scrolling command)	Number, 0 or 1, describing the scrolling mode. 0 is word-scrolling; the DPS string will scroll word by word, or multiple words when they fit. 1 is character-scrolling; the DPS string will scroll character by character.  Example: DPSM=0
REV	Software Version (special command)	Typing this command (no = or ?) returns the current RDS encoder software version.  Example: REV // issue version command Nautel NVE RDS Encoder V1.0 // exciter response

**Other Settings tab:**

- **Pilot Level:** enter value between 6 and 12% (typically 9%); this level is added to the composite baseband
- **Pilot 1 PPS Sync:** select Enabled or Disabled. If Enabled, enter:
  - Pilot Sync Phase (enter value between 0 and 360 degrees; typically 0 degrees)
- **Audio Delay:** Used to time align the receiver output of decoded analog and digital audio signals. Select Enabled or Disabled. If Enabled, enter:
  - Audio Delay: enter value between 0 and 12,000 ms (default is 0)
- **Mod (Modulation) Loss Timeout:** select Enabled or Disabled. If Enabled, enter:
  - Action: Alarm Only (no resulting action), RF Inhibit (inhibits the RF output and fans until the audio returns) or Change Preset (changes the active preset).
  - Mod Loss Preset: displayed only if Action is set to Change Preset. Select the preset from the drop down list that will activate upon the loss of a modulating signal, post the timeout period.
  - Timeout Minutes: sets the delay, in minutes, between modulation loss detection and the resulting action. Enter a value in the allowable range of 0 and 255 minutes.
  - Timeout Seconds: sets the delay, in seconds, between modulation loss detection and the resulting action. Enter a value in the allowable range of 0 and 59.9 seconds.
  - Threshold: sets the threshold for modulation loss detection. Enter a value in the allowable range of 0 and 100% (default is 0%) (see [Configuring an audio loss backup preset - see page 4-5](#) for detailed instructions).
- **Hard Limiter:** If enabled, the modulation level will be limited (audio signal clipped or distorted) if it exceeds the hard limit threshold. Select Enabled or Disabled. If Enabled, enter:
  - Hard Limit: enter value between 0 and 160% (default is 160%)

- **AGC Limiter:** If Enabled, when the modulation level exceeds the AGC Limit, the gain of the audio input will instantly decrease in order to reduce the modulation level below the AGC limit threshold. Recovery from this audio gain reduction is dependent on the Time Constant delay (fast attack, slow recovery). The input signal is briefly distorted by the audio gain reduction when the threshold is exceeded. Select Enabled or Disabled. If Enabled, enter:
  - AGC Limit: enter value between 0 and 160% (default is 120%)
  - Time Constant: enter value between 0 and 1000 ms (default is 300 ms)
  
- **Two Slope Limiter:** If Enabled, when the modulation level exceeds the Threshold, the gain of the audio input will instantly change according to the gain percentage setting (percentage of the initial gain, which is below the threshold). The input signal is distorted by the audio gain change.
  - Threshold: enter value between 0 and 160% (default is 160%)
  - Gain: enter value between 0 and 100% (default is 50%)
  
- **L/R Limiter:** This look-ahead limiter can be applied to the signal immediately before the stereo generator in the exciter. It has a fixed attack-time (and corresponding delay) of approximately 1 s. It can be configured to reduce the signal, if the gain setting is 0 dB or less, or can be used to perform an AGC function and boost quiet sections of the audio if a positive gain setting is used. If Enabled, enter the following parameters:
  - Max Gain: enter value between -30 and 30 dB (default is 12 dB)
  - Decay Time: enter value between 0 and 60 s (default is 5 s)
  - Hold Time: enter value between 0 and 60 s (default is 5 s)
  
- **MPX Power Limiter:** If Enabled, enter MPX RMS Limit. This limit allows the broadcast signal to remain in compliance with the MPX power limits as suggested in ITU-R BS.412-9. While the limiter will keep the transmitter in compliance, it is recommended that adjustment to the processing be made in such a way to minimize the reductions performed by the limiter. Otherwise the signal will not take advantage of the peak modulation capability available.
  - MPX RMS Limit: enter value between -12 and 12 dBr (default is 0 dBr)

Note: MPX RMS is displayed as a percentage (%) on the meters screen. The percentage (%) equivalent for the dBr range shown above are 4.5% (-12 dBr) to 71.3% (12 dBr); default is 17.9% (0 dBr).

**Figure 2.46: Presets - Other Settings Tab** (scroll to see all options)

General	Main Audio	SCA	RDS	Other Settings
Pilot Level		9.0	%	
Pilot 1PPS Sync		Enabled		
Pilot Sync Phase		0	°	
Audio Delay		Enabled		
Audio Delay		0.000	ms	
Mod Loss Timeout		Enabled		
Action		Change Preset		
Mod Loss Preset				
Timeout Minutes		0	min	
Timeout Seconds		5.0	sec	
Threshold		0	%	
Hard Limiter		Enabled		
Hard Limit		160	%	
AGC Limiter		Enabled		
AGC Limit		120	%	
Time Constant		300	ms	
Two Slope Limiter		Enabled		
Threshold		160	%	
Gain		50.0	%	
L/R Limiter		Enabled		
Max Gain		12.0	dB	
Decay Time		5.000	s	
Hold Time		5.000	s	
MPX Power Limiter		Enabled		
MPX RMS Limit		0.0	dBr	

**SAVING PRESETS.** Click the Save button to save preset information.

**DELETING PRESETS.** From the Presets page, click the Delete button. Highlight the preset you wish to delete, noting you cannot delete an active (on-air) preset. Click the Delete button to delete the preset from the list. Click the Cancel button or X to close this window and return to the Presets page.

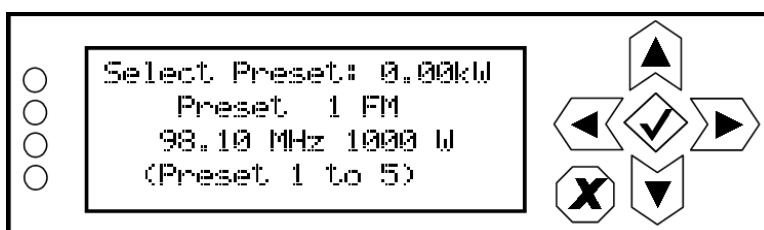
## MANAGING PRESETS - USING THE FRONT PANEL

Many preset settings available on the front panel UI are also available on the remote AUI. In this case, if you change a preset setting on the front panel UI, it will also be reflected on the remote AUI, and vice versa.

### SELECTING THE ACTIVE PRESET

When you choose Select Preset from the Main Menu (see [Figure 2.47](#)) you can select the active preset for transmitter operation.

**Figure 2.47: Select Preset screen**

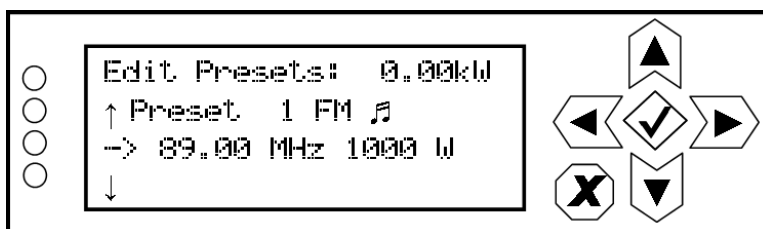


Use the up and down buttons to scroll through the existing presets. Press the accept (checkmark) button to enable the preset as the transmitter's active preset. Press the cancel (X) button to return to the previous menu.

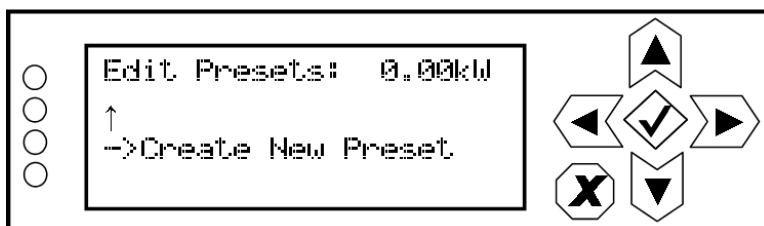
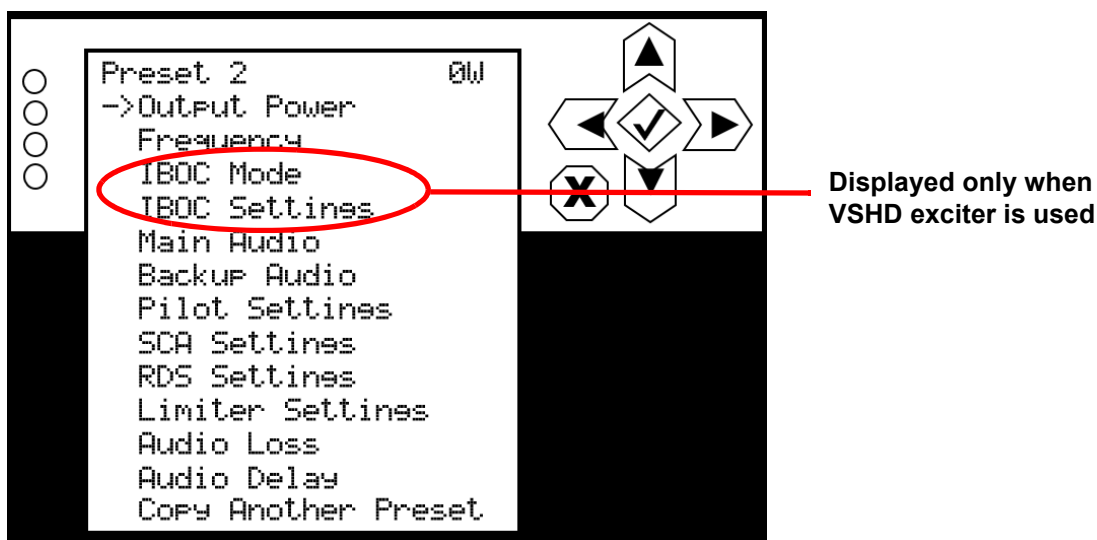
### EDITING OR CREATING PRESETS

When you select User Settings -> Edit Presets from the Main Menu (see [Figure 2.48](#)) you can create up to 63 operating presets or edit existing presets.

**Figure 2.48: Edit Preset screen**



Use the up and down buttons to scroll through the existing presets, or scroll to the bottom of the list to Create New Preset (see [Figure 2.49 on page 2-76](#)). Press the accept (checkmark) button to enter the editing menu for that preset (see [Figure 2.50 on page 2-76](#)). Press the cancel (X) button to return to the previous menu. When you create a new preset, the next available preset number is assigned (e.g., Preset 5).

**Figure 2.49: Create New Preset screen****Figure 2.50: Preset Editing menu**

Within the preset editing menu, use the up and down buttons to scroll through the options and press the accept (checkmark) button to enter the selected editing menu/screen. Press the cancel (X) button to return to the previous menu. Parameters that can be edited are:

**OUTPUT POWER.** See [Figure 2.51 on page 2-77](#). Use the up and down buttons to edit the output power (in 1 W increments, then press the accept (checkmark) button to save the change.

For analog only transmitters [FM (analog) mode only], the maximum power setting is **2800 W**.

For transmitters connected to VSHD exciters, the maximum power setting is dependent on the mode of operation, injection level (as applicable) and carrier frequency (as applicable). See [Table 2.5 on page 2-77](#).

Press the cancel (X) button to discard changes and return to the previous menu.

Figure 2.51: Output Power screen (analog power ranges shown)

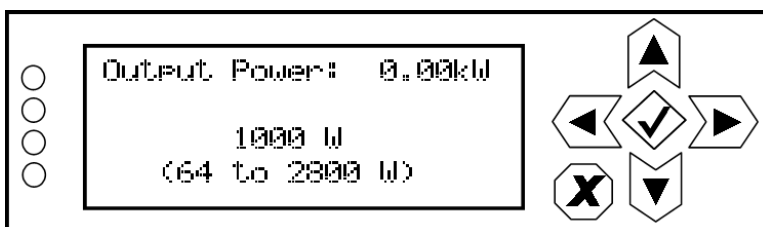


Table 2.5: Maximum power level set points \*\*

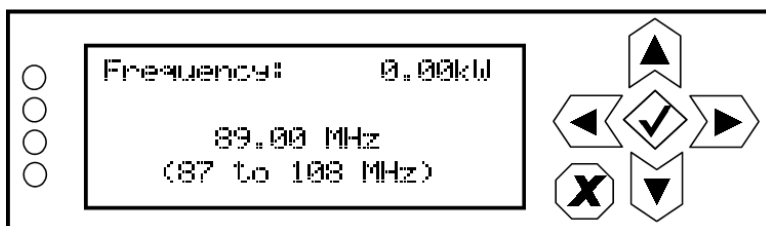
Mode and IBOC Injection Level (as applicable for IBOC modes)	Maximum Power Set Point Limit (W) (linearly interpolate between frequencies)					
	88.0 MHz		98.0 MHz		108.0 MHz	
	MER Priority	Efficiency Priority	MER Priority	Efficiency Priority	MER Priority	Efficiency Priority
FM+HD, -20 dB	2394	2651	2366	2518	2432	2613
FM+HD, -19 dB	2256	2537	2285	2473	2275	2446
FM+HD, -18 dB	2118	2424	2204	2428	2119	2279
FM+HD, -17 dB	1977	2285	2109	2355	1968	2119
FM+HD, -16 dB	1833	2145	2014	2282	1818	1959
FM+HD, -15 dB	1686	1980	1905	2181	1674	1806
FM+HD, -14 dB	1539	1815	1796	2081	1530	1653
FM+HD, -13 dB	1388	1623	1673	1952	1391	1507
FM+HD, -12 dB	1237	1432	1549	1823	1253	1361
FM+HD, -11 dB	1081	1215	1411	1667	1110	1219
FM+HD, -10 dB	926	998	1273	1511	988	1083
FM	2394		2366		2432	
HD, -20 dB	960 (all frequencies)					
HD, -14 dB	780 (all frequencies)					
HD, -10 dB	700 (all frequencies)					

\*\* Maximum power set point limits can vary from the indicated value for various reasons. Nautel does not guarantee performance at the indicated values.



**FREQUENCY.** See [Figure 2.52](#). Use the up and down buttons to edit the output power (in 0.01 MHz increments, then press the accept (checkmark) button to save the change. Press the cancel (X) button to return to the previous menu.

**Figure 2.52: Frequency screen**



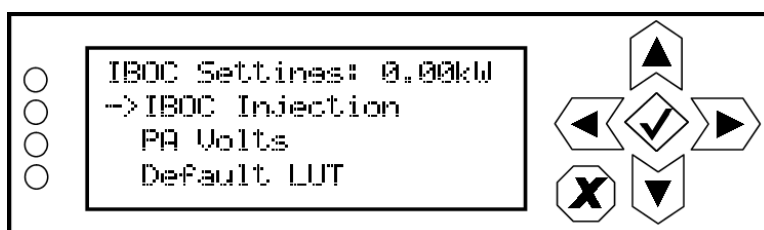
**IBOC MODE.** See [Figure 2.53](#). Use the up and down buttons to locate the desired mode of operation - FM, FM+HD or HD, then press the 'accept' (checkmark) button to save the change. Press the cancel (X) button to discard changes and return to the previous menu.

**Figure 2.53: IBOC Mode screen**

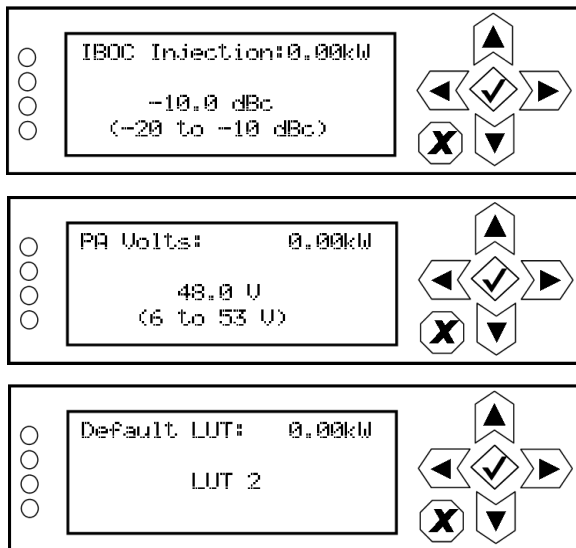


**IBOC SETTINGS.** When you select IBOC Settings from the Preset editing options screen (viewable only when IBOC Mode is set to HD or FM+HD), you can edit various IBOC parameters (see [Figure 2.54](#)).

**Figure 2.54: IBOC Settings menu**



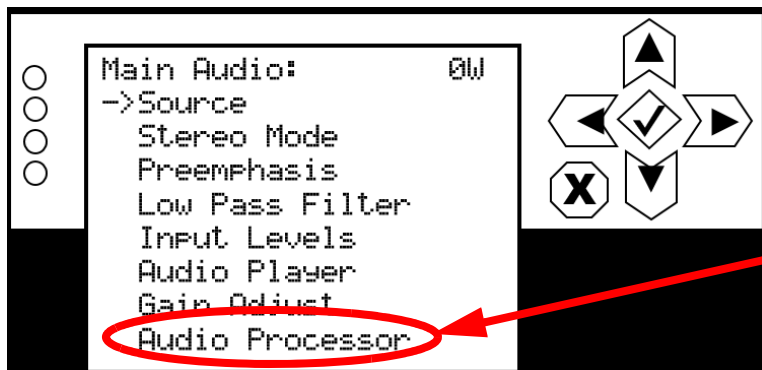
Use the up and down buttons to scroll through the main audio menu options, then press the accept (checkmark) or right arrow button to enter the selected editing screen. [Figure 2.55](#) shows the editing screens for the IBOC Settings menu. Press the cancel (X) button to discard changes and return to the previous menu.

**Figure 2.55: IBOC Settings editing screens**

- **IBOC Injection:** Use the up and down buttons to select an IBOC injection level between -20 and -10 dBc (in 0.1 dB increments), then press the accept (checkmark) button to save the change. Press the cancel (X) button to discard changes and return to the previous menu.
- **PA Volts:** Use the up and down buttons to select a PA voltage between 6 and 53 V (in 1 V increments), then press the accept (checkmark) button to save the change. Press the cancel (X) button to discard changes and return to the previous menu.
- **Default LUT:** Use the up and down buttons to select Flat LUT or LUT 1 through LUT 12, then press the accept (checkmark) button to save the change. Press the cancel (X) button to discard changes and return to the previous menu.

**MAIN AUDIO.** When you select Main Audio from the Preset editing options screen, you can edit various main audio parameters (see [Figure 2.56](#)).

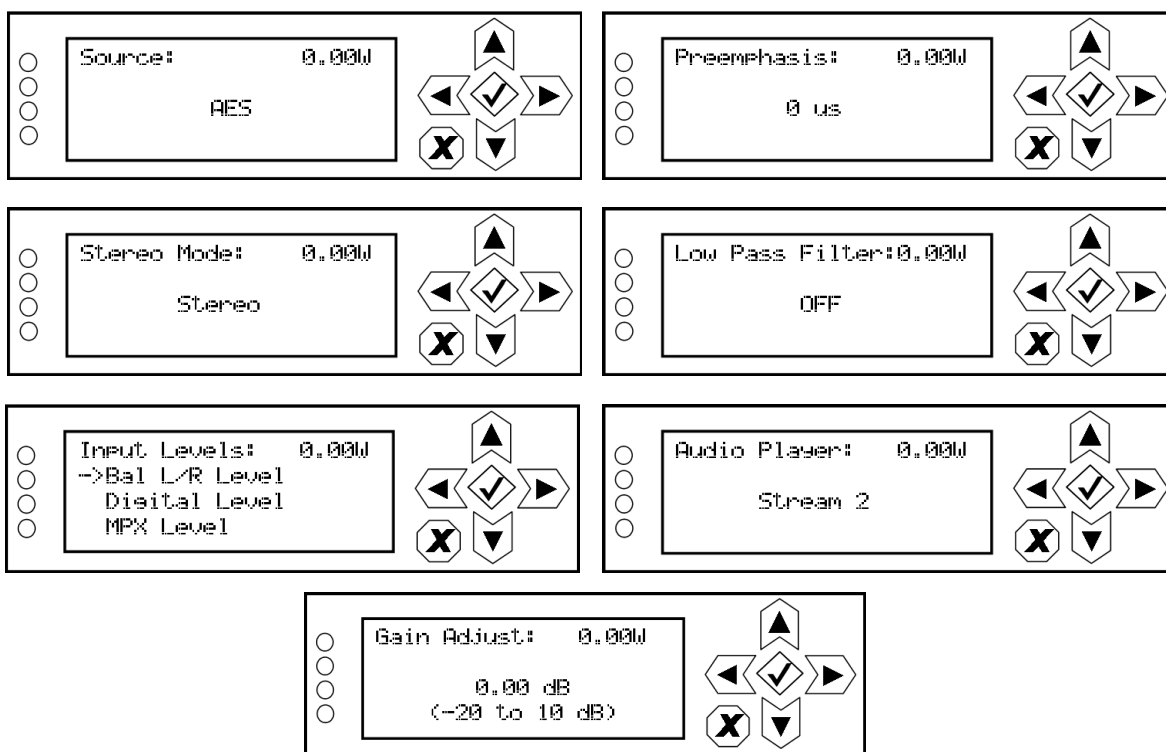
**Figure 2.56: Main Audio menu**



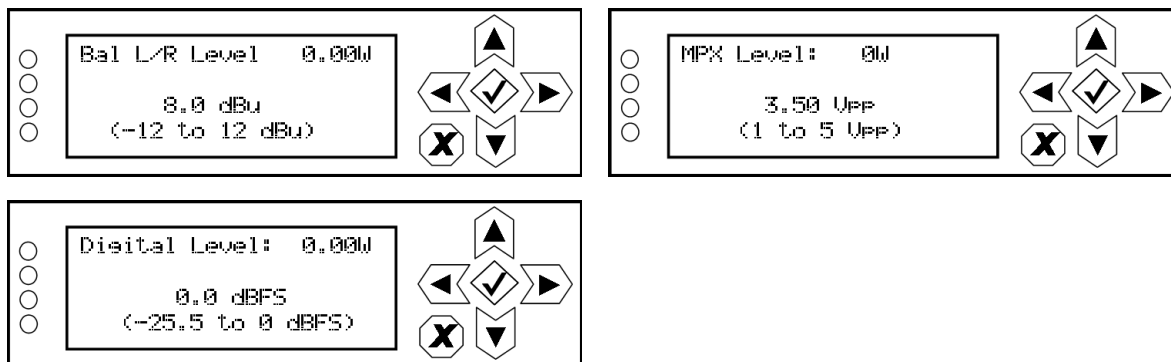
If Orban Inside is installed, see [Enabling the Orban Audio Processor for Preset Selection](#) - see page 2-186

Use the up and down buttons to scroll through the main audio menu options, then press the accept (checkmark) or right arrow button to enter the selected editing screen. [Figure 2.57](#) shows the editing screens for the Main Audio menu. Press the cancel (X) button to discard changes and return to the previous menu.

**Figure 2.57: Main Audio editing screens**



- **Source:** Use the up and down buttons to locate the desired audio source - AES, MPX, Analog L/R or Audio Player -> AES 2, then press the accept (checkmark) button to save the change. Press the cancel (X) button to discard changes and return to the previous menu.
- **Stereo Mode:** Use the up and down buttons to locate the desired stereo mode - Stereo, Right Mono, Left Mono or L+R Mono then press the accept (checkmark) button to save the change. Press the cancel (X) button to discard changes and return to the previous menu.
- **Preemphasis:** Use the up and down buttons to locate the desired preemphasis characteristic - 0 us, 25 us, 50 us or 75 us, then press the accept (checkmark) button to save the change. Press the cancel (X) button to discard changes and return to the previous menu.
- **Low Pass Filter:** Use the up and down buttons to toggle between ON or OFF, then press the accept (checkmark) button to save the change. Press the cancel (X) button to discard changes and return to the previous menu.
- **Input Levels:** Use the up and down buttons to move the cursor to the desired audio input and then press the right button to enable editing of the parameter. [Figure 2.58 on page 2-82](#) shows all the editing screens for the Input Levels sub-menu. Within any of the editing screens, use the up and down buttons to edit a parameter value, noting the minimum and maximum limitations indicated at the bottom of the display. When complete, press the accept (checkmark) button to save the change. Press the cancel (X) button to discard changes and return to the previous menu.
- **Audio Player:** Use the up and down buttons to select File Playlist or Stream 1 through Stream 255, then press the accept (checkmark) button to save the change. Press the cancel (X) button to discard changes and return to the previous menu.
- **Gain Adjust:** Use the up and down buttons to select gain adjust level between -20 and 10 dB (in 0.01 dB increments), then press the accept (checkmark) button to save the change. Press the cancel (X) button to discard changes and return to the previous menu.
- **Audio Processor:** See [Enabling the Orban Audio Processor for Preset Selection - see page 2-186](#) for information on the Enable and Preset sub-menus.

**Figure 2.58: Input Levels editing screens**

- Bal L/R Level: Select a level between -12 and 12 dBu.
- MPX Level: Select a level between 1 and 5 V peak-to-peak.
- Digital Level: Select a level between -25.5 and 0 dBFS.

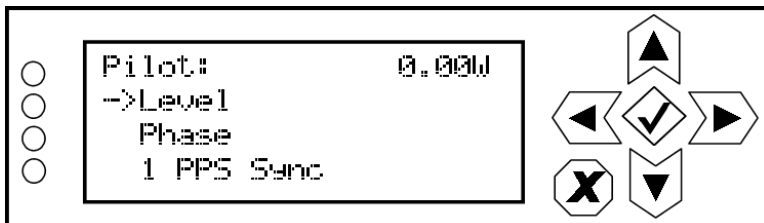
**BACKUP AUDIO.** When you select Backup Audio from the Preset editing options screen, you can enable a backup audio source and edit various backup audio parameters (see [Figure 2.59](#)).

**Figure 2.59: Backup Audio menu**

Use the up and down buttons to scroll through the backup audio menu options, then press the accept (checkmark) or right arrow button to enter the selected editing screen. With the exception of the Enable screen (select ON to enable, OFF to disable), the editing screens for the Backup Audio menu are the same as the Main Audio menu (see [Figure 2.57 on page 2-80](#)). Press the cancel (X) button to discard changes and return to the previous menu.

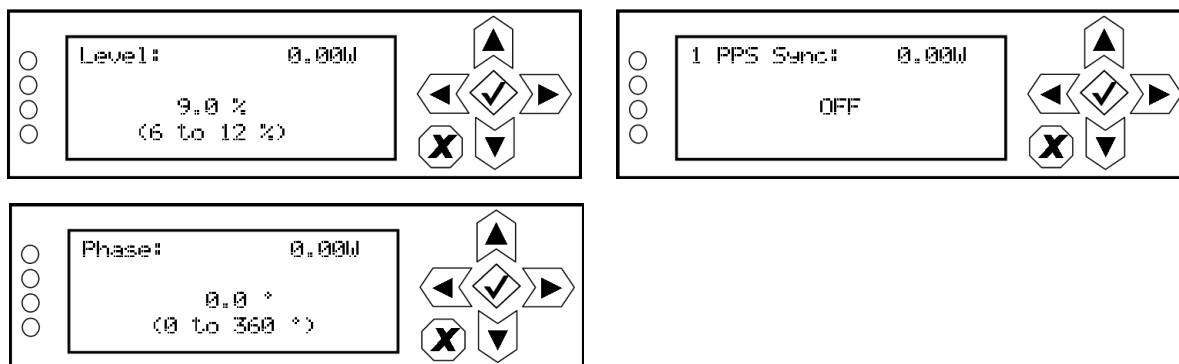
**PILOT SETTINGS.** When you select Pilot Settings from the Preset editing options screen, you can edit the settings of the pilot signal (see [Figure 2.60](#)).

**Figure 2.60: Pilot Settings menu**



Use the up and down buttons to move the cursor to the desired pilot setting and then press the right button to enable editing of the parameter. [Figure 2.61](#) shows all the editing screens for the Pilot Settings menu. Within any of the editing screens, use the up and down buttons to edit or toggle a parameter value, noting the minimum and maximum limitations indicated at the bottom of the display. When complete, press the accept (checkmark) button to save the change. Press the cancel (X) button to discard changes and return to the previous menu.

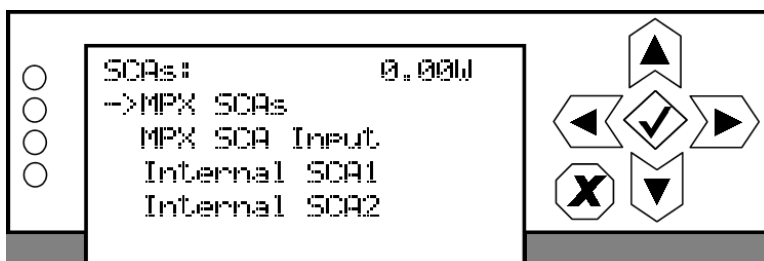
**Figure 2.61: Pilot Settings editing screens**



- Level: Select a level between 6 and 12%.
- Phase: Select a phase angle between 0 and 360 degrees.
- 1 PPS Sync: Select ON or OFF.

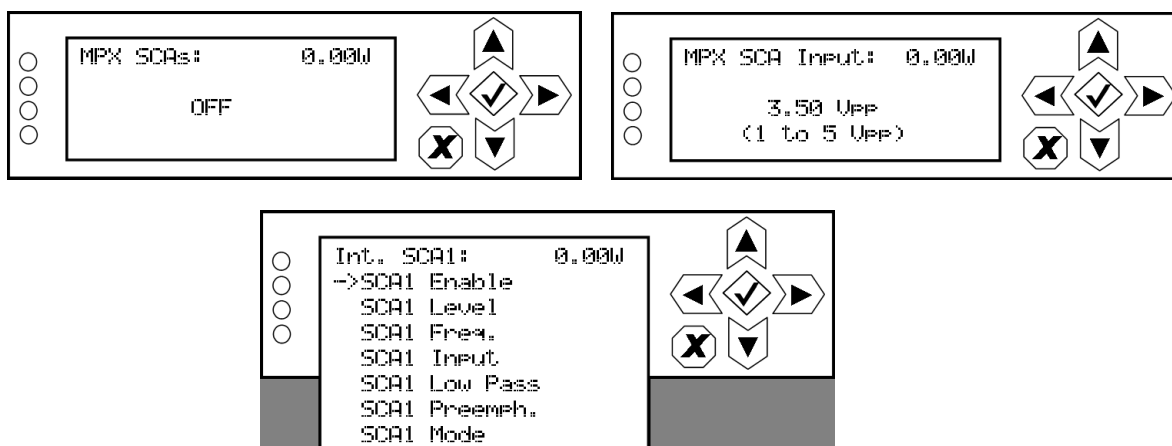
**SCA SETTINGS.** When you select SCA Settings from the Preset editing options screen, you can edit various SCA parameters (see [Figure 2.62](#)).

**Figure 2.62: SCA Settings menu**

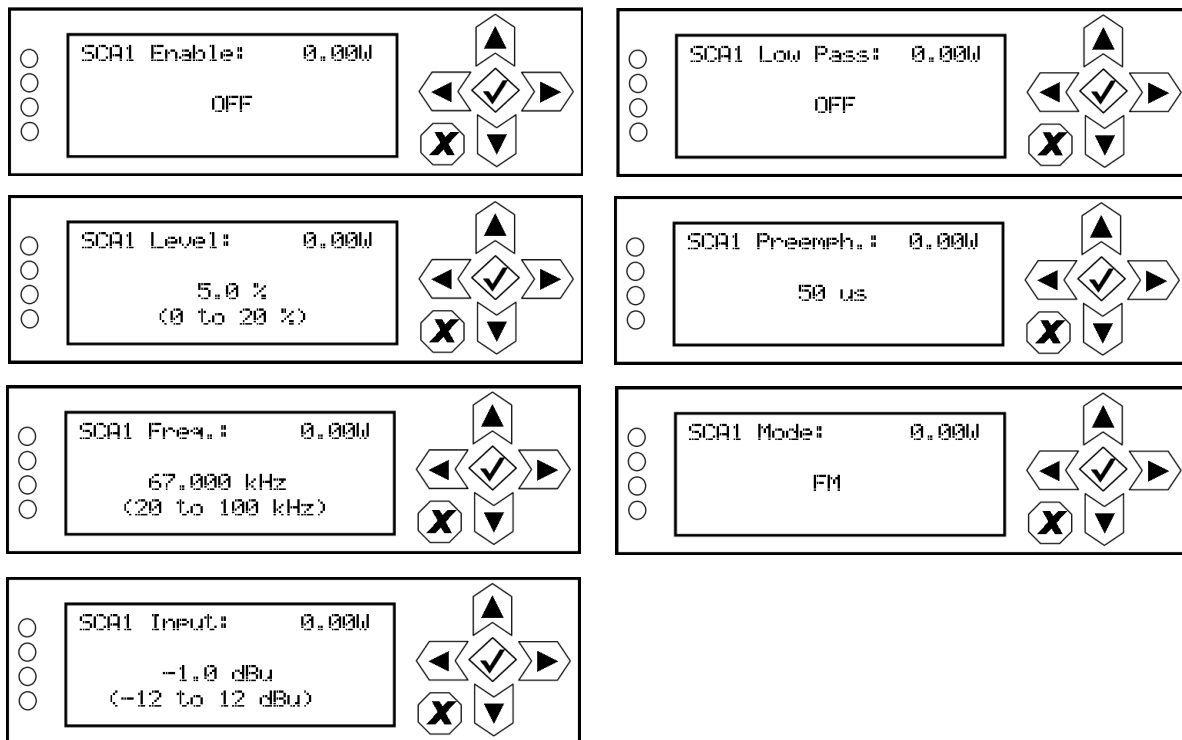


Use the up and down buttons to move the cursor to the desired SCA setting and then press the right button to enable editing of the parameter. [Figure 2.63](#) shows all the editing screens for the SCA Settings menu. Within any of the editing screens, use the up and down buttons to edit or toggle a parameter value, noting the minimum and maximum limitations indicated at the bottom of the display. When complete, press the accept (checkmark) button to save the change. Press the cancel (X) button to discard changes and return to the previous menu. If you select Internal SCA1 or Internal SCA2, there is a sub-menu that contains additional SCA settings (see [Figure 2.64 on page 2-85](#)).

**Figure 2.63: SCA Settings editing screens**



- MPX SCAs: Select ON or OFF.
- MPX SCA Input: Select a level between 1 and 5 V peak-to-peak (of MPX SCAs is ON).
- Int. SCA1 or Int. SCA2 (see [Figure 2.64 on page 2-85](#)).


**Figure 2.64: Internal SCA1 and SCA2 editing screens**

- SCA Enable: Select ON or OFF.
- SCA Level: Select a level between 0 and 20%.
- SCA Freq: Select a frequency between 20 and 100 kHz.
- SCA Input: Select a level between -12 and 12 dBu.
- SCA Low Pass: Select ON or OFF.
- SCA Preemph: Select the desired pre-emphasis characteristic - 0 us, 50 us, 75 us or 150 us.
- SCA Mode: Select FM or DSB-SC.

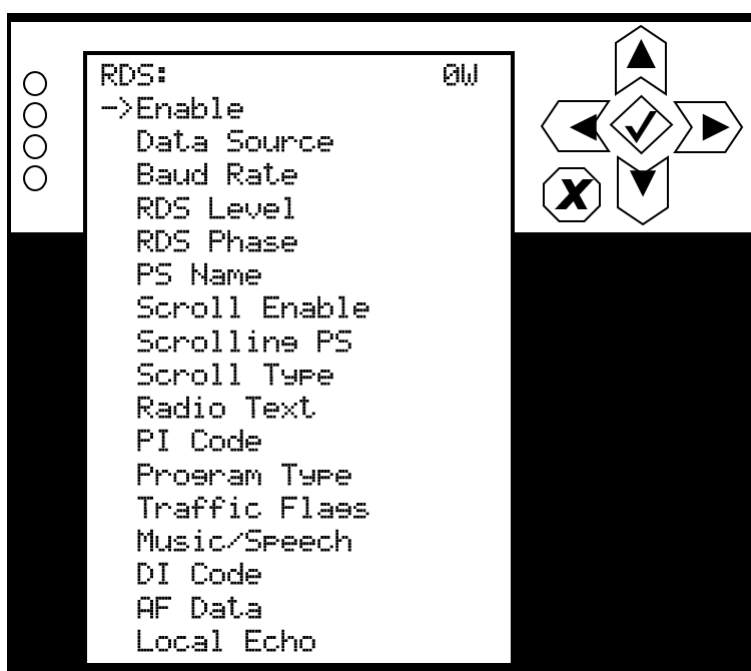


**RDS SETTINGS.** When you select RDS Settings from the Preset editing options screen, you can edit various RDS parameters (see [Figure 2.65](#)).

If you change a preset setting on the front panel UI, it will also be reflected on the remote AUI, and vice versa.

 *Note:*  
*RDS Settings have been described in detail in the remote AUI section. See [page 2-64](#) for more information.*

**Figure 2.65: RDS Settings menu**

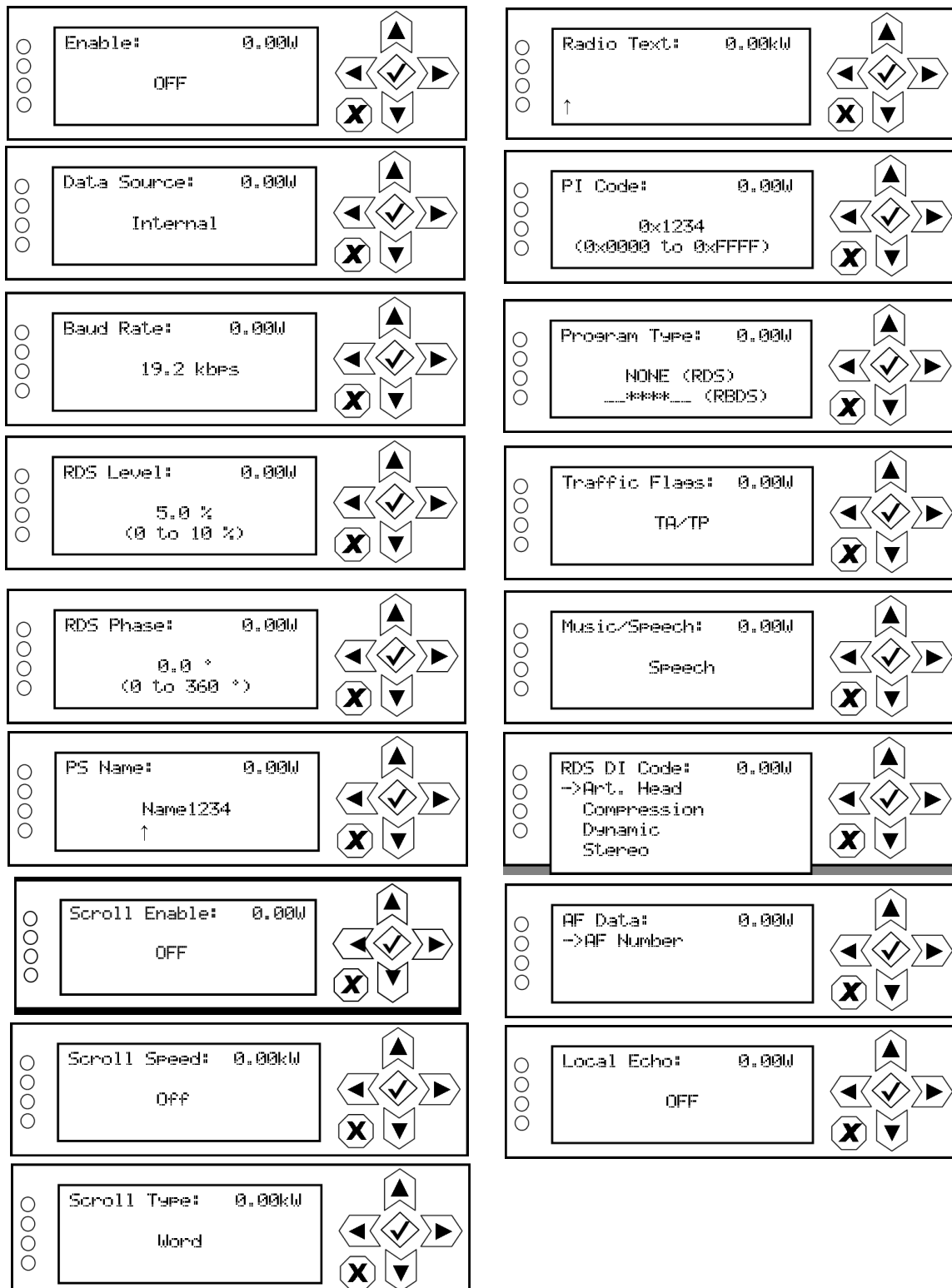


Use the up and down buttons to move the cursor to the desired RDS setting and then press the right button to enable editing of the parameter.

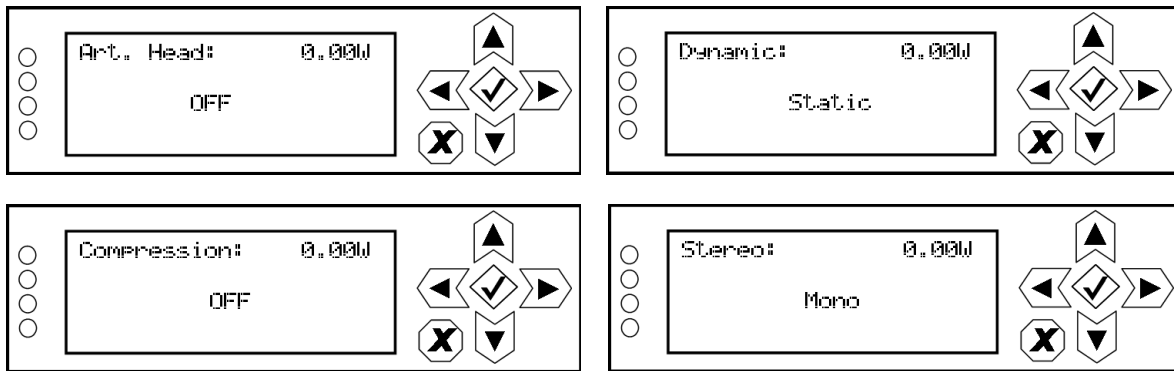
[Figure 2.66 on page 2-87](#) shows all the editing screens for the RDS Settings menu. Within any of the editing screens, use the arrow buttons to edit or toggle a parameter value, noting the minimum and maximum limitations indicated at the bottom of the display (as applicable). If you select DI Code (see [Figure 2.67 on page 2-88](#)) or AF Data (see [Figure 2.68 on page 2-88](#)), there are associated sub-menus that contain additional setting options.

When complete, press the accept (checkmark) button to save the change. Press the cancel (X) button to discard changes and return to the previous menu.

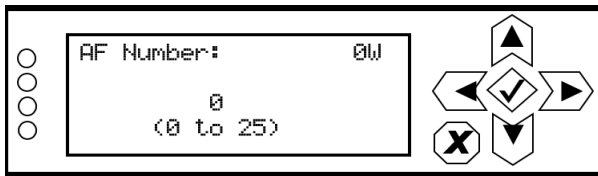
Figure 2.66: RDS Settings editing screens



**Figure 2.67: DI Code editing screens**

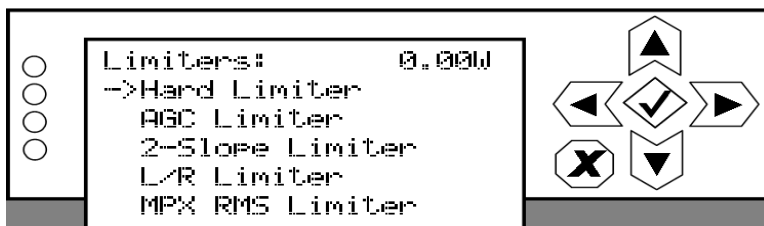


**Figure 2.68: AF Data editing screen**



**LIMITER SETTINGS.** When you select Limiter Settings from the Preset editing options screen, you can edit various limiter parameters (see [Figure 2.69](#)).

**Figure 2.69: Limiter Settings menu**

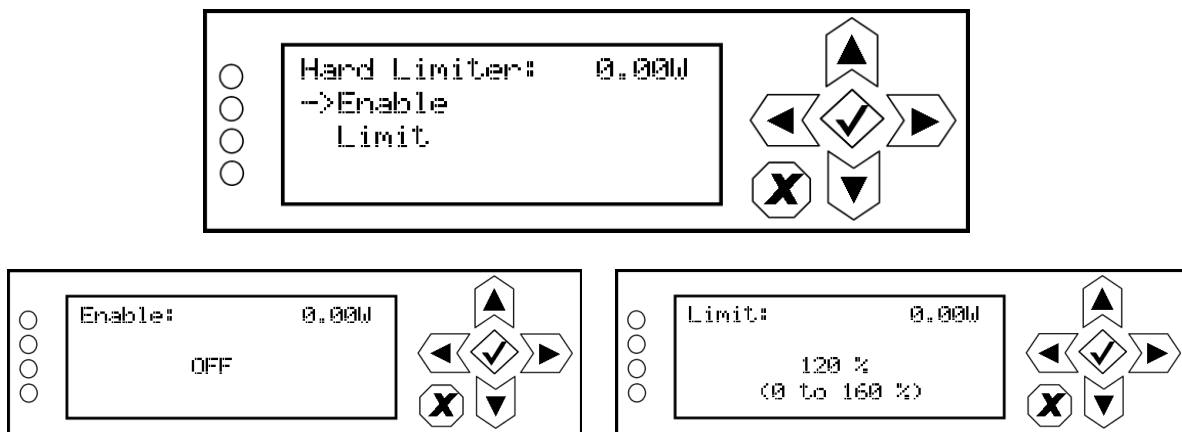


Use the up and down buttons to move the cursor to the desired limiter and then press the right button to enter the associated sub-menu for:

- Hard Limiter (see [Figure 2.70](#))
- AGC Limiter (see [Figure 2.71 on page 2-90](#))
- 2-Slope Limiter (see [Figure 2.72 on page 2-91](#)).
- L/R Limiter (see [Figure 2.73 on page 2-92](#))
- MPX RMS Limiter (see [Figure 2.74 on page 2-93](#))

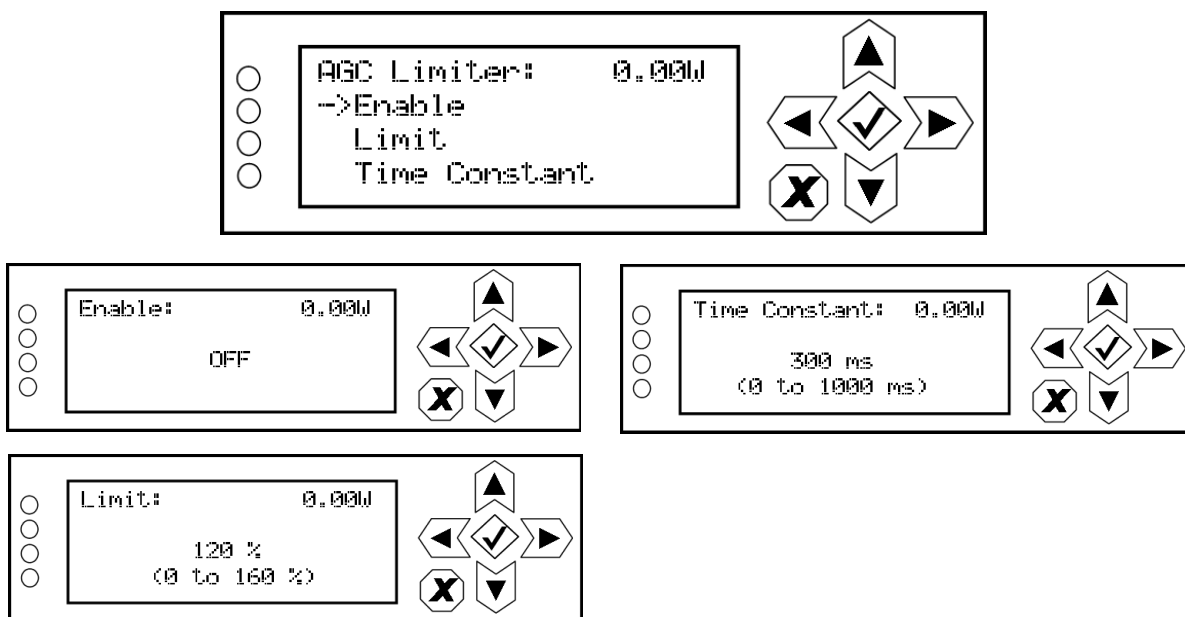
Within a sub-menu, use the up and down buttons to move the cursor to the desired limiter setting and then press the right button to enter the associated editing screen. Within any of the editing screens, use the arrow buttons to edit or toggle a parameter value, noting the minimum and maximum limitations indicated at the bottom of the display (as applicable). When complete, press the accept (checkmark) button to save the change. Press the cancel (X) button to discard changes and return to the previous menu.

**Figure 2.70: Hard Limiter sub-menu and editing screens**



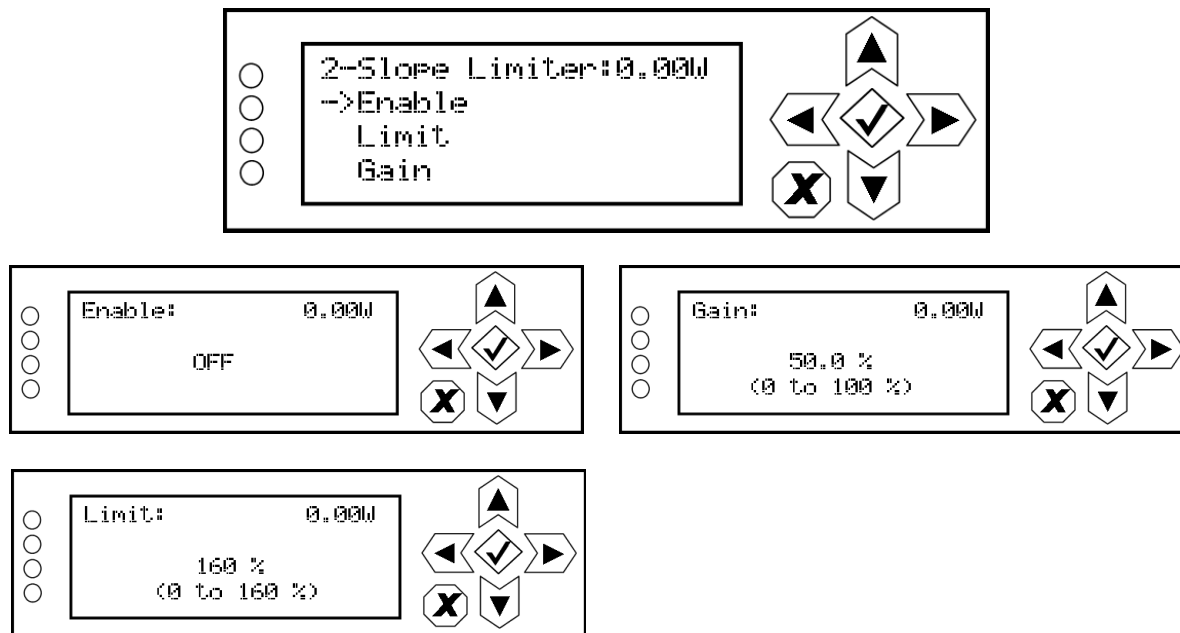
- Enable: Select ON or OFF.
- Limit: Select a value between 0 and 160%.

**Figure 2.71: AGC Limiter sub-menu and editing screens**



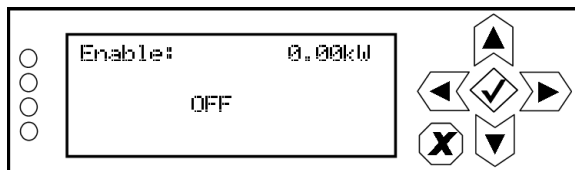
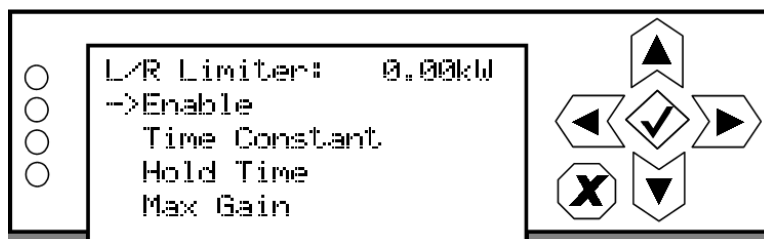
- Enable: Select ON or OFF.
- Limit: Select a value between 0 and 160%.
- Time Constant: Select a value between 0 and 100 ms.

Figure 2.72: 2-Slope Limiter sub-menu and editing screens

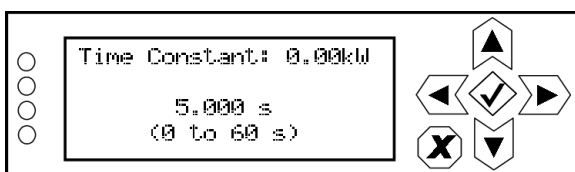


- Enable: Select ON or OFF.
- Limit: Select a value between 0 and 160%.
- Gain: Select a value between 0 and 100%.

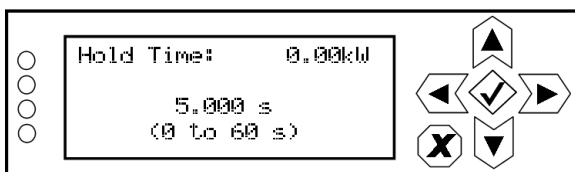
**Figure 2.73: L/R Limiter sub-menu and editing screens**



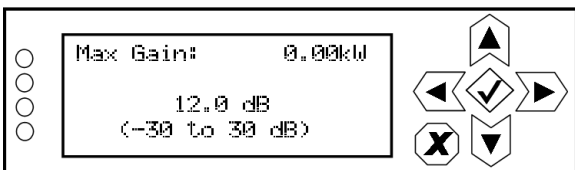
Use the up and down arrows to select ON or OFF, then press the accept (checkmark) button to save the change. Press the cancel (X) button to discard changes and return to the previous menu. Default selection is OFF.



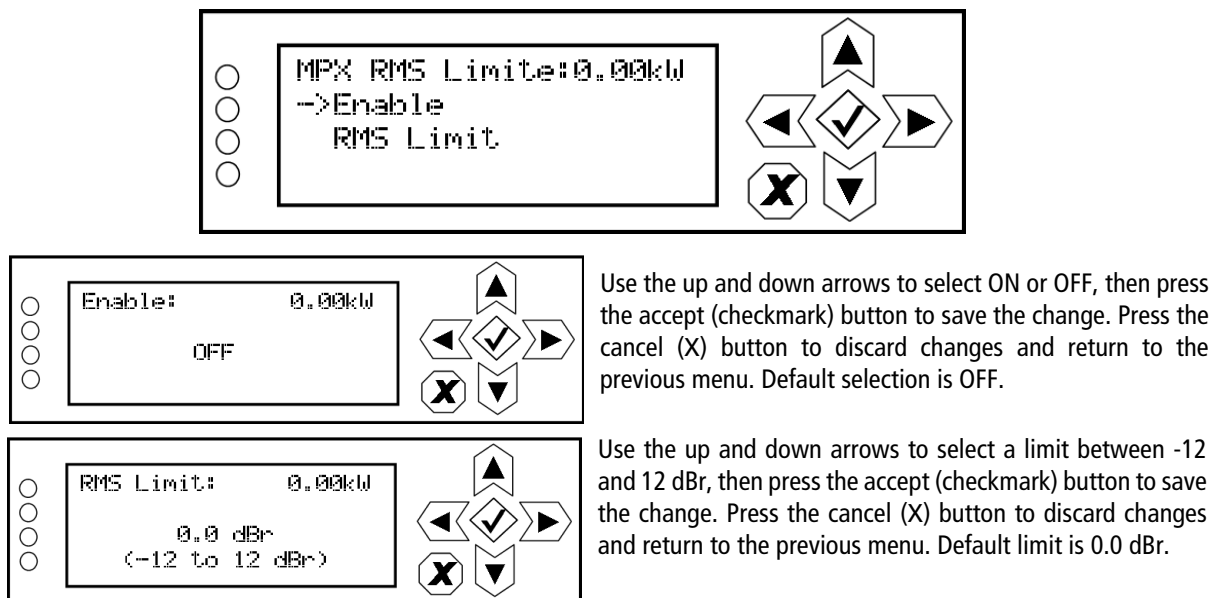
Use the up and down arrows to select a time constant between 0 and 60 s, then press the accept (checkmark) button to save the change. Press the cancel (X) button to discard changes and return to the previous menu. Default time constant is 5.000 s.



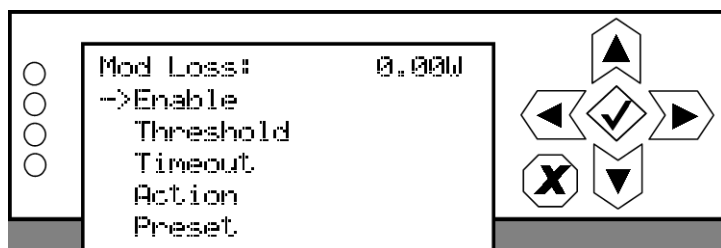
Use the up and down arrows to select a hold time between 0 and 60 s, then press the accept (checkmark) button to save the change. Press the cancel (X) button to discard changes and return to the previous menu. Default hold time is 5.000 s.



Use the up and down arrows to select a maximum gain between -30 and 30 dB, then press the accept (checkmark) button to save the change. Press the cancel (X) button to discard changes and return to the previous menu. Default gain is 12.0 dB.

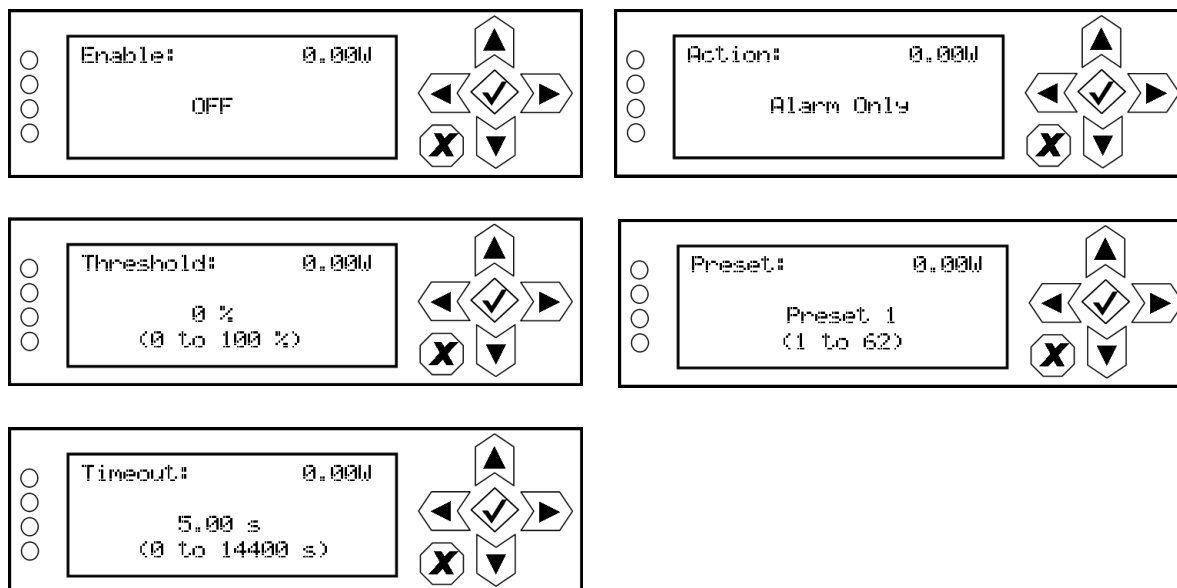
**Figure 2.74: MPX RMS Limiter sub-menu and editing screens**

**MOD LOSS.** When you select Mod Loss from the Preset editing options screen, you can edit the parameters related to an audio loss (see [Figure 2.75](#)).

**Figure 2.75: Mod Loss menu**

Use the up and down buttons to move the cursor to the desired mod loss menu item and then press the right button to enable editing of the item. [Figure 2.76](#) shows all the editing screens for the Mod Loss menu. Within any of the editing screens, use the up and down buttons to edit a parameter value, noting the minimum and maximum limitations indicated at the bottom of the display (as applicable). When complete, press the accept (checkmark) button to save the change. Press the cancel (X) button to discard changes and return to the previous menu.



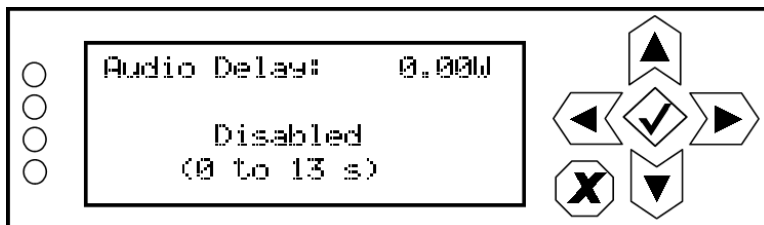
**Figure 2.76: Mod Loss editing screens**

- **Enable:** Determines whether the audio loss feature is used. Select ON or OFF.
- **Threshold:** Sets the audio threshold below which the transmitter will take action. Select a value between 0 and 100%.
- **Timeout:** Sets the time period of low audio (based on the threshold setting) after which the transmitter will take action. Select a value between 0 and 14400 seconds (240 minutes).
- **Action:** Determines the action taken by the transmitter when the audio has been below the threshold for the timeout period. Select Alarm Only, Change Preset or RF Inhibit.
- **Preset:** Determines the preset that becomes active after an audio loss if the audio loss action is set to Change Preset.

See [Configuring an audio loss backup preset - see page 4-5](#) for detailed instructions.

**AUDIO DELAY.** When you select Audio Delay from the Preset editing options screen, you can edit or disable the audio delay period (see [Figure 2.77](#)).

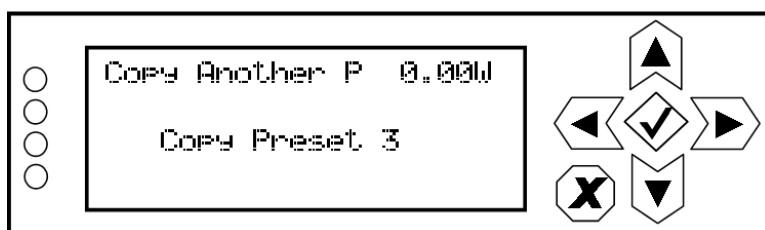
**Figure 2.77: Audio Delay menu**



Use the up and down buttons to change the audio delay setting between disabled and any time period between 0 and 13 seconds, then press the accept (checkmark) button to save the change. Press the cancel (X) button to discard changes and return to the previous menu.

**COPY ANOTHER PRESET.** When you select Copy Another Preset from the Preset editing options screen, you can copy the settings from another preset into the preset that is being edited (see [Figure 2.78](#)). Note the preset being edited is displayed in parentheses [e.g., (P3)].

**Figure 2.78: Copy Another Preset Screen**



Use the up and down buttons to select the preset (see available presets in parentheses on the bottom line of the display) that you wish to copy to the selected preset for editing. Press the accept (checkmark) button to save the change. Press the cancel (X) button to discard changes and return to the previous menu.

---

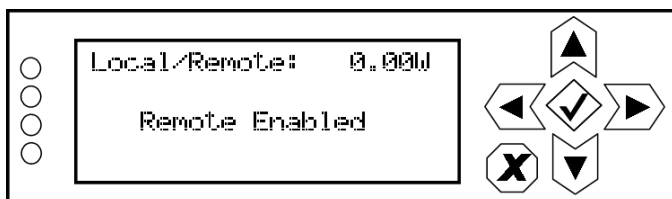
## ENABLING REMOTE CONTROL

Users can enable remote control via the front panel display (see [Using the front panel](#) below). AUI users are by default using the transmitter in remote mode.

### USING THE FRONT PANEL

When you select Local/Remote from the Main Menu, you can set the local/remote operating control for the VS2.5 (see [Figure 2.79](#)).

**Figure 2.79: Local/Remote Selection Screen**



Use the up and down buttons to toggle between Local Only and Remote Enabled. Press the accept (checkmark) button to save the change. Press the cancel (X) button to discard changes and return to the previous menu.

---

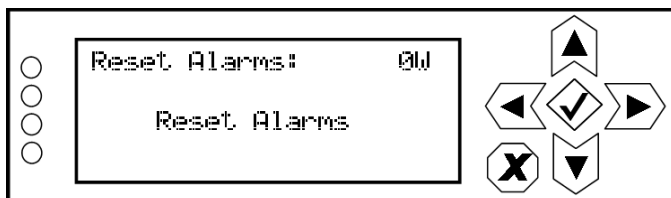
## RESETTING ALARMS

You can attempt to reset any latching transmitter alarms that are holding the transmitter in an “off-air” state using the remote AUI’s Reset button (see [Reset: on page 2-18](#)) or the local front panel UI (see below).

### USING THE FRONT PANEL

When you select Reset Alarms from the Main Menu, you can attempt to reset latched protection circuits in the VS2.5 (see [Figure 2.80](#)). If the alarm condition has been cleared, the alarm indication on the View Alarms screen should disappear.

**Figure 2.80: Reset Alarms Screen**



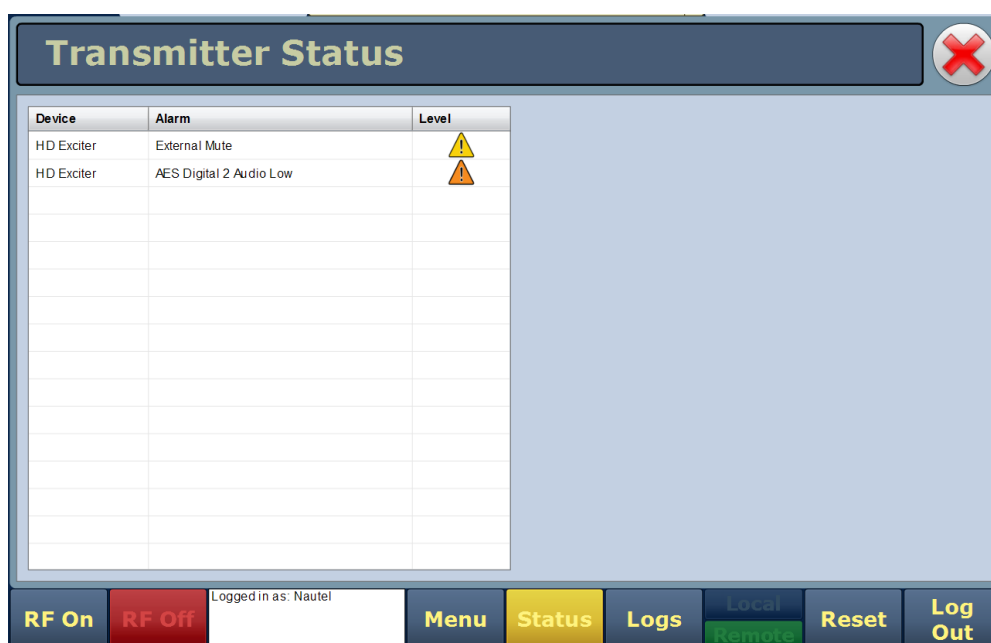
Use the up and down buttons to toggle between Reset Alarms and Cancel. Press the accept (checkmark) button to save the change. Press the cancel (X) button to go to the previous menu.

## VIEWING TRANSMITTER STATUS

You can view the VS2.5’s operational status using the AUI’s [Transmitter Status page](#) - see [Figure 2.81](#). This page shows current active alarms to aid in fault diagnosis. To view the [Transmitter Status page](#), click the Status button in the AUI’s bottom banner. Click X to return to the home page.

You can also use the front panel UI to view active alarms (see [Transmitter Log - Using the front panel on page 2-28](#)).

**Figure 2.81: Transmitter Status page**



The Transmitter Status page displays all active transmitter alarms. Alarms are listed by their host device (Controller or Exciter), alarm name and severity level [a single orange ! indicates low severity (RF output not affected); a single red ! indicates medium severity (RF output is reduced); three red ! indicates high severity (RF output is inhibited)]. Refer to the VS2.5 Troubleshooting Manual for detailed information on alarm details such as root cause and troubleshooting tips.

Click the Reset button at the bottom of any AUI screen to attempt to clear any latching alarms that are holding the transmitter in an “off-air” state (see [Reset: on page 2-18](#)). If the offending alarm has cleared, the transmitter should resume operation.

---

## SYSTEM SETTINGS

This section includes the following topics:

- [Rebooting the AUI or Exciter - see page 2-100](#)
- [Upgrading Software - see page 2-101](#)
- [Calibrating Audio Inputs - see page 2-102](#)
  - [Calibrating Audio - Using the AUI - see page 2-102](#)
  - [Calibrating Audio Inputs - see page 2-121](#)
- [IBOC settings - VSHD only - see page 2-103](#)
- [Spectrum/Efficiency Optimizer - see page 2-104](#)
  - [Spectrum/Efficiency Optimizing - Using the AUI - see page 2-104](#)
  - [HD Optimizing - Using the front panel UI - see page 2-105](#)
- [Calibrating Exciter TCXO - see page 2-107](#)
  - [Calibrating Exciter TCXO - Using the AUI - see page 2-107](#)
  - [Calibrating Exciter TCXO - Using the front panel UI - see page 2-108](#)
- [FM Polarity - see page 2-109](#)
  - [Setting FM Polarity - Using the AUI - see page 2-109](#)
  - [Setting FM Polarity - Using the front panel UI - see page 2-110](#)

From the remote AUI's **System Settings** page via the **Main Menu** options (see [Figure 2.82](#)), you can reboot the remote AUI or the exciter, perform software upgrades to the transmitter, calibrate the exciter's TCXO and audio inputs, establish IBOC settings (if applicable) and set FM polarity.



*Note:*

*The front panel UI also has a System Settings menu, which contains similar functions to the AUI (e.g., calibrating the exciter's TCXO and calibrating audio inputs), and additional settings that are described in [System Settings - Front Panel UI - see page 2-111](#). Unless otherwise noted, the following functions are only available via a LAN connection to the remote AUI.*

**Figure 2.82: Main Menu - System Settings**

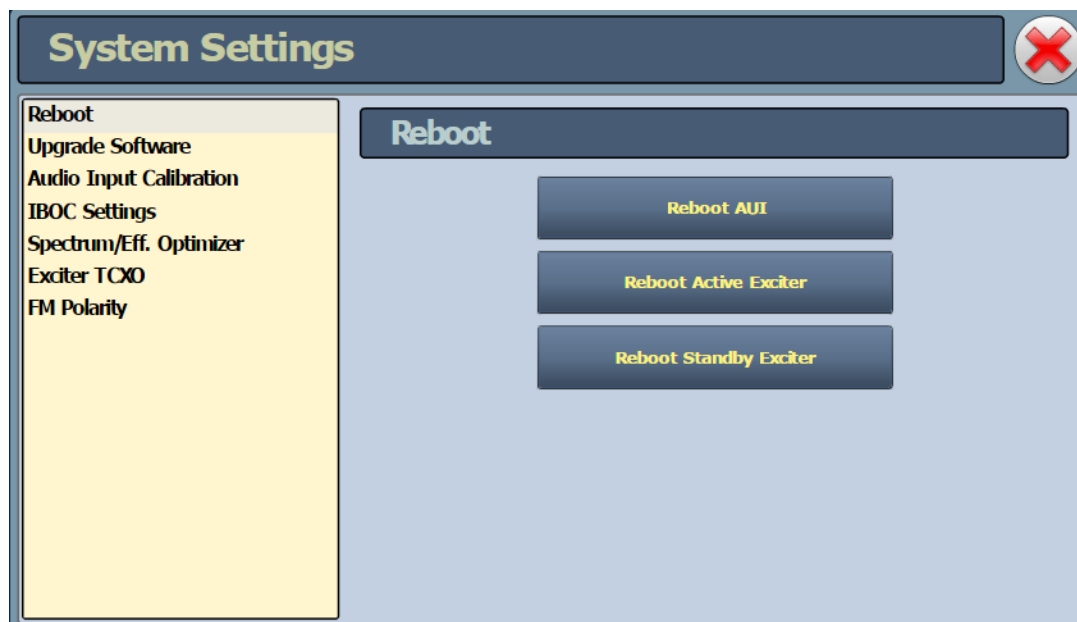
The following options are available:

- **Reboot:** Allows for rebooting of the AUI or the exciter (active or standby, as applicable) (see [Rebooting the AUI or Exciter on page 2-100](#)). There is also a host reboot function, available through the front panel UI (see [Host Reboot on page 2-112](#)).
- **Upgrade Software:** Allows for uploading software upgrade files for various transmitter sub-systems (e.g., Controller, Exciter, etc.) (see [Upgrading Software on page 2-101](#)).
- **Audio Input Calibration:** Allows for calibration of analog and MPX audio inputs (see [Calibrating Audio Inputs on page 2-102](#)).
- **IBOC Settings:** Allows users to establish Forward Tap Delay, FM+HD Low Inj Gain, FM+HD High Inj Gain and HD only system Gain levels (see [IBOC settings - VSHD only on page 2-103](#)). This option only exists when operating with VSHD.
- **Spectrum/Efficiency Optimizer:** Allows users to optimize the transmitter's spectrum and/or efficiency (see [Spectrum/Efficiency Optimizer on page 2-104](#)). This option only exists when operating with VSHD.
- **Exciter TCXO:** Allows for calibration of the internal clock reference to an external 10 MHz clock or manually entered based on an off-air frequency measurement (see [Calibrating Audio Inputs on page 2-102](#)). Can also be done locally.
- **FM Polarity:** Allows users to set the polarity for frequency modulation (see [FM Polarity on page 2-109](#)).

## REBOOTING THE AUI OR EXCITER

You can reset (reboot) the AUI or the exciter using the remote AUI Reset page. To view the AUI's Reboot page (see [Figure 2.83](#)), select Reboot from the System Settings option.

**Figure 2.83: System Settings - Reboot**



- To reboot the AUI, click the **Reboot AUI** button. This will function with remote control enabled or disabled. After the reboot delay, you must log in to the AUI again to reset the host (see also [Firmware Update on page 2-114](#)).
- To reset the active exciter, click the **Reboot Active Exciter** button, if the button is available (highlighted).

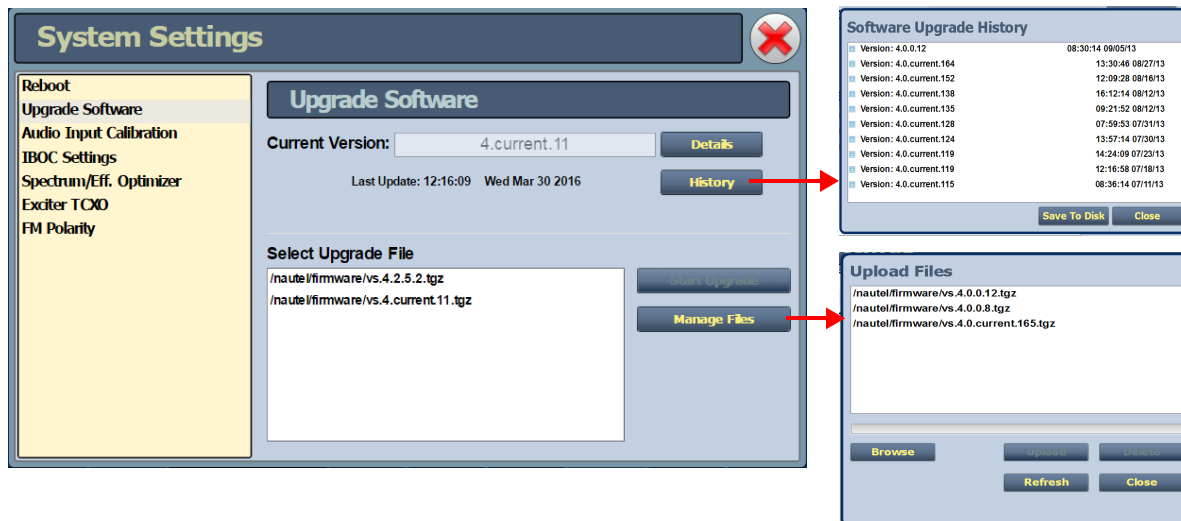
**Note:**  
*If the active exciter is rebooted, a brief interruption in transmitter operation will occur.*

- To reset the standby exciter (for dual exciters), click the **Reboot Standby Exciter** button, if the button is available (highlighted).
- Click X in the upper, right corner to close this page and return to the home page.

## UPGRADING SOFTWARE

The AUI's Upgrade Software page (see [Figure 2.84 on page 2-101](#)), in the System Settings list, allows for uploading a suite of software upgrade files (.tgz files) via remote connection. Navigate the page as described below. For additional information on loading software, see [Upgrading software on page 4-1](#). The page consists of the following sections and button.

**Figure 2.84: System Settings - Upgrade Software**



- **Current Version:** indicates the current software version.
- **Select Upgrade File:** displays the available upgrade files uploaded to the transmitter.
- **Details:** opens a window containing information about the installed software. If an upgrade file is selected, the screen shows a comparison between the installed version and the selected upgrade by component. Identical versions are shown in green; different versions are shown in red. You can also view the details of the previous upgrade by pressing the View Last Upgrade checkbox.
- **History:** displays a window containing a history of the upgrades to the software. Press the + button to maximize the details of the software. You can save this information to disk as a .txt file from the remote AUI.
- **Start Upgrade:** begins to upgrade the current software with the selected upgrade file.
- **Manage Files** (available through the remote AUI only): opens a window displaying the files you can upload to upgrade the software. You can add or delete files from this list using the Browse, Upload and Delete buttons in the window.



## CALIBRATING AUDIO INPUTS

You can calibrate analog and MPX (composite) audio inputs using the remote AUI (see [Calibrating Audio - Using the AUI](#)) or the local front panel UI (see “[Calibrating Audio Inputs](#)” on page 2-121).



**Note:**

*Audio inputs are factory set using a high accuracy source and do not typically require user adjustment. Changes to factory calibrations could cause low or excessive modulation and non-compliance to strict regulatory limits. If you need to re-calibrate the audio input, ensure you have a reliable and correctly calibrated audio source.*

### CALIBRATING AUDIO - USING THE AUI

To view the AUI's Audio Input Calibration page (see [Figure 2.85](#)), select Audio Input Calibration from the System Settings page. The peak meter value of each calibrated audio input (analog left, analog right, MPX or MPX SCA, Int. SCA1 or Int. SCA2) that is applied will be displayed. Enter a valid calibration value and click Set to save the changes. Click X in the upper, right corner to close this page and return to the home page.

**Figure 2.85: System Settings - Audio Input Calibration Page**

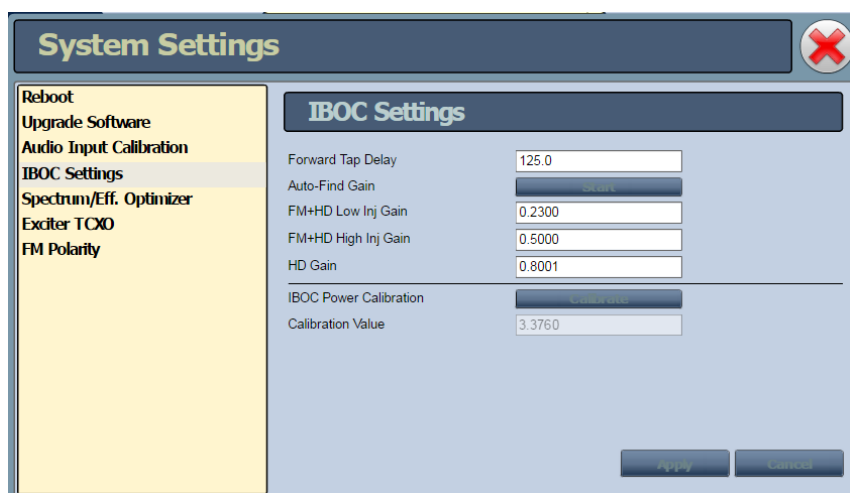
System Settings		Audio Input Calibration	
Reboot	Analog Left Peak	-83.9 dBu	Apply
Upgrade Software	Analog Right Peak	-82.5 dBu	Apply
<b>Audio Input Calibration</b>	MPX Peak	0 Vpp	Apply
IBOC Settings	MPX SCA Peak	N/A	Apply
Spectrum/Eff. Optimizer	Int. SCA1 Peak	-84.2 dBu	Apply
Exciter TCXO	Int. SCA2 Peak	-84.9 dBu	Apply
FM Polarity			

## IBOC SETTINGS - VSHD ONLY

This system setting (see [Figure 2.86](#)) allows users to establish Forward Tap Delay, FM+HD Low Inj Gain, FM+HD High Inj Gain and HD only system Gain levels. It also allows for an IBOC power calibration. Changes apply to the active exciter (A or B) only. To calibrate the other exciter, switch to the other exciter and repeat the change.

- **Forward Tap Delay:** This field displays the time delay (in unit taps) between the forward path signal from the exciter and the reverse path signal into the exciter, fed back from the output of the transmitter. This value is factory adjusted (to synchronize the phase of the forward and reverse signals so that pre-correction can operate properly) and should not require any adjustment in the field.
- **Auto-Find Gain:** Press the Start button to automatically find the optimized gain while the transmitter is RF On and in the applicable preset mode/injection level.
- **FM+HD Low Inj Gain:** Applicable for FM+HD mode only (at -20dBc to -15.1dBc injection levels) and represents the starting/default gain applied to the forward path signal within the exciter at initial turn on/ramp-up.
- **FM+HD High Inj Gain:** Applicable for FM+HD mode only (at -15dBc to -10dBc injection level) and represents the starting/default gain applied to the forward path signal within the exciter at initial turn on/ramp-up.
- **HD Gain:** Applicable for HD mode only and represents the starting/default gain applied to the forward path signal within the exciter at initial turn on/ramp-up.
- **IBOC Power Calibration:** This calibration occurs at the factory and should not require any adjustment in the field. This calibration is performed in FM mode.
- **Calibration Value:** This field displays the calibration of the exciter's measurement of the transmitter power.

**Figure 2.86: System Settings - IBOC Settings**



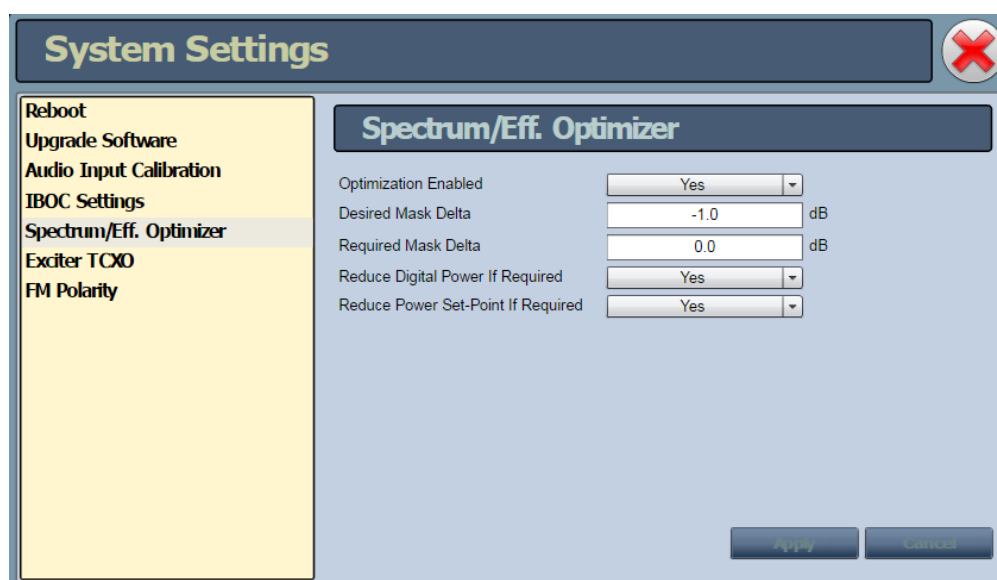
## SPECTRUM/EFFICIENCY OPTIMIZER

The Spectrum/Eff. Optimizer page (or the HD Optimizer screen) allows users to optimize the transmitter's spectrum and/or efficiency. You can perform this optimization using the remote AUI (see [Spectrum/Efficiency Optimizing - Using the AUI](#)) or the local front panel UI (see [HD Optimizing - Using the front panel UI on page 2-105](#)).

### SPECTRUM/EFFICIENCY OPTIMIZING - USING THE AUI

To view the AUI's Spectrum/Eff. Optimizer page (see [Figure 2.87](#)), select Spectrum/Eff. Optimizer from the System Settings page.

**Figure 2.87: System Settings - Spectrum/Efficiency Optimizer**



Adjust the following parameters. When complete, click **Apply** to save the changes. Click **X** in the upper, right corner to close this page and return to the home page:

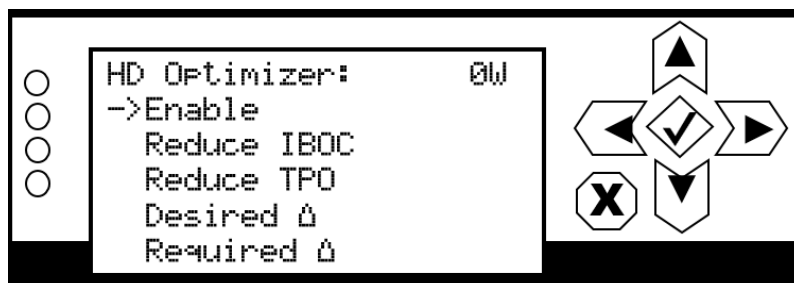
- Optimization Enabled - Select Yes or No. Selecting Yes allows the optimizer to adjust the PA voltage setting to maximize efficiency based on the transmitter output spectrum. Depending on other settings in this section, it may require other actions to maintain the transmitter's compliance.
- Desired Mask Delta - Set the desired clearance (between -10 dB and 0 dB) from the spectral mask. The default setting is -1 dB, which will maintain a 1 dB clearance from the mask for maximum efficiency. This setting will not cause a reduction in output power.

- Required Mask Delta - Sets the value (between -10 db and 10 dB) that is considered to be absolutely required. If this level is exceeded, the digital power from the transmitter will be reduced if the PA voltage is at maximum. If the spectral mask still cannot be met and the setting for it is enabled, the transmitter power set-point will be reduced.
- Reduce Digital Power If Required: Select Yes or No. Selecting Yes enables a reduction in injection level (digital power) if the spectrum mask requires it.
- Reduce Power Set-Point If Required: Select Yes or No. Selecting Yes enables a reduction in the transmitter power set-point if the spectrum mask requires it.

### HD OPTIMIZING - USING THE FRONT PANEL UI

From the front panel UI, you can enable and configure various HD signal parameters (e.g., injection level, TPO, etc.) in an attempt to optimize the digital signal's overall efficiency. To view the HD Optimizer screen, select System Settings -> HD Optimizer from the Main Menu (see [Figure 2.88](#)).

**Figure 2.88: HD Optimizer Menu**

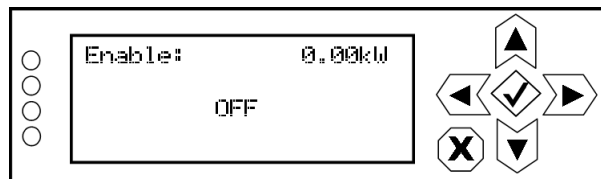


This menu has five sub-menu options:

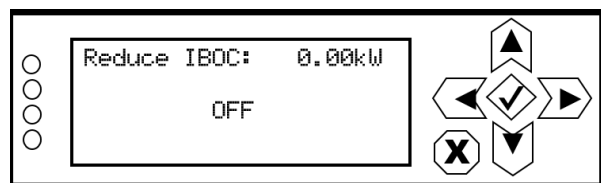
- Enable
- Reduce IBOC
- Reduce TPO
- Desired Delta
- Required Delta

Use the up and down buttons to move the cursor to the desired setting and then press the right button to enable editing of the setting. [Figure 2.89 on page 2-106](#) shows the editing screens for the HD Optimizer menu. Within any of the editing screens, use the up and down buttons to edit a setting. Press the accept (checkmark) button to save the change. Press cancel (X) to discard changes and return to the previous menu.

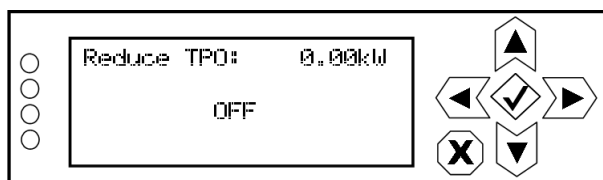
**Figure 2.89: HD Optimizer Screens**



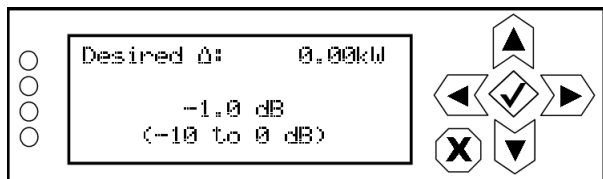
Select ON to allow the optimizer to adjust the PA voltage setting to maximize efficiency based on the transmitter output spectrum. Depending on other settings in this section, it may require other actions to maintain the transmitter's compliance. Select OFF to disable. When disabled, other HD Optimizer settings will have no effect.



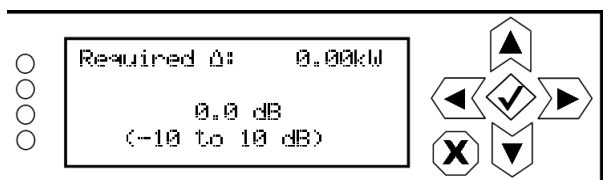
Select ON to enable a reduction in IBOC injection (digital power) if the spectrum mask requires it. Select OFF to disable this setting.



Select ON to enable a reduction in the power set-point if the spectrum mask requires it. Select OFF to disable this setting.



Set the desired clearance (between -10 dB and 0 dB) from the spectral mask. The default setting is -1 dB, which will maintain a 1 dB clearance from the mask for maximum efficiency. This settings will not cause any reduction in output power.



Sets the value (between -10 db and 10 dB) that is considered to be absolutely required. If this level is exceeded, the digital power from the transmitter will be reduced if the PA voltage is at maximum. If the spectral mask still cannot be met and the setting for it is enabled, the transmitter power set-point will be reduced. Default setting is 0.0 dB.

## CALIBRATING EXCITER TCXO

You can calibrate the internal clock reference to an external 10 MHz clock or manually enter an offset value using the remote AUI (see [Calibrating Exciter TCXO - Using the AUI](#)) or the local front panel UI (see [Calibrating Exciter TCXO - Using the front panel UI - see page 2-108](#)).



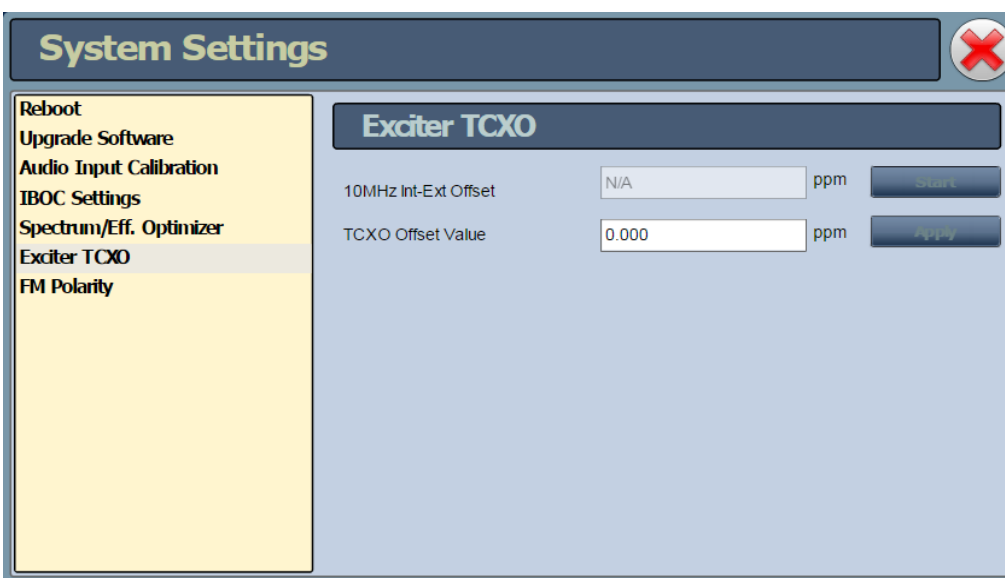
**Note:**

*During calibration, the external 10 MHz clock should be connected to the EXT 10 MHz IN (A1J4B) BNC connector on the rear of the controller or to the 10 MHz IN (W2J1) BNC connector on the rear of the optional exciter.*

### CALIBRATING EXCITER TCXO - USING THE AUI

To view the AUI's Exciter TCXO screen (see [Figure 2.90](#)), select Exciter TCXO from the System Settings options.

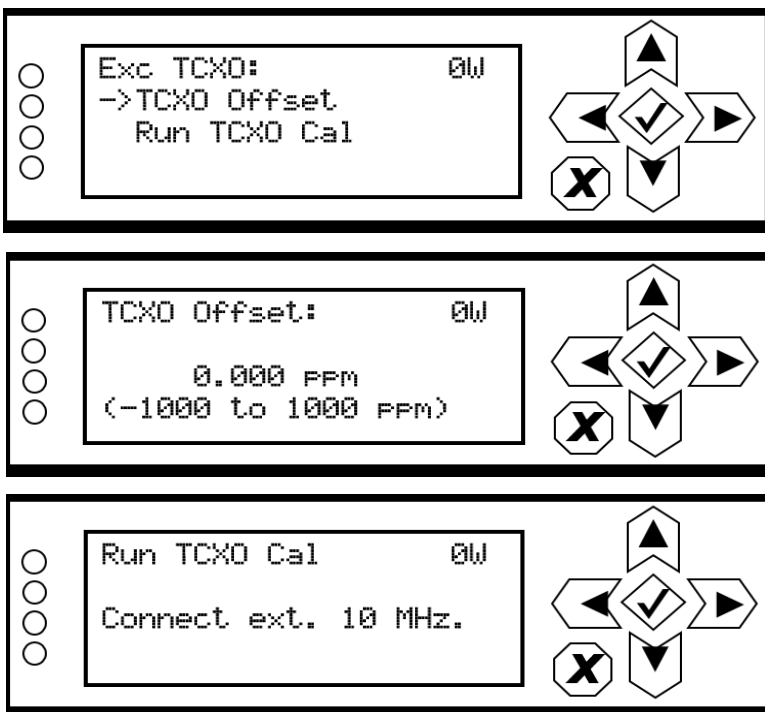
**Figure 2.90: System Settings - Exciter TCXO**



To automatically calibrate the internal reference for the exciter, click the Start button. The progress bar at the bottom of the page will indicate that the calibration is in progress or complete. The TCXO Offset Value will appear when calibration is complete. Alternatively, if the required offset value is known, you can manually enter it in the TCXO Calibration Value field and click the Apply button.

**CALIBRATING EXCITER TCXO - USING THE FRONT PANEL UI**

To view the front panel's TCXO calibration screens (see [Figure 2.91](#)), select System Settings -> Exc TCXO from the Main Menu.

**Figure 2.91: Front Panel - TCXO Calibration**

Use the up or down arrow to place the cursor next to TCXO Offset, then press the accept (checkmark) button to enter the TCXO Offset screen. Use the up and down arrows to set the TCXO offset value (in ppm) for the external 10 MHz source. When complete, press the accept (checkmark) button to save the change. Press cancel (X) to discard changes and return to the previous menu.

From the Exc TCXO menu, press the down arrow to place the cursor next to Run TCXO Cal, then press the accept (checkmark) button to enter the Run TCXO Cal screen. The calibration routine will begin when the external 10 MHz source is connected.

## FM POLARITY

The FM Polarity page (see [Figure 2.92](#)) allows users to invert the polarity of the frequency modulation. You can set FM polarity using the remote AUI (see [Setting FM Polarity - Using the AUI](#)) or the local front panel UI (see [Setting FM Polarity - Using the front panel UI - see page 2-110](#)).



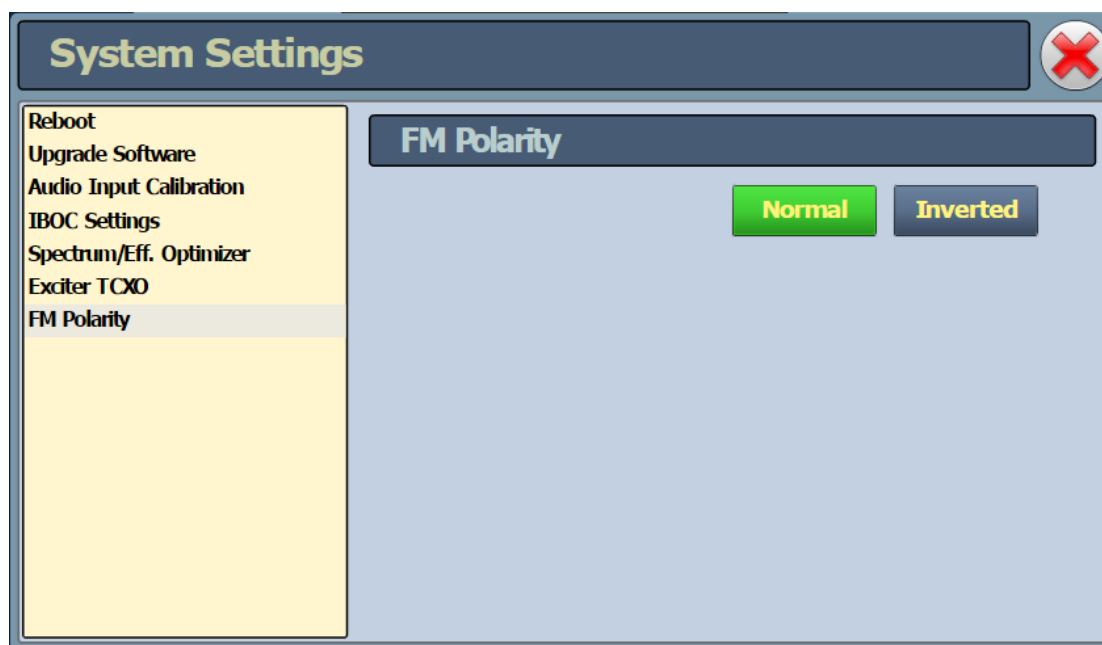
*Note:*

*Adjusting FM polarity is used to synchronize transmitters for a single-frequency network. It determines whether positive audio input results in positive or negative modulation.*

### SETTING FM POLARITY - USING THE AUI

To view the AUI's FM Polarity screen (see [Figure 2.92](#)), select Exciter FM Polarity from the System Settings options.

**Figure 2.92: System Settings - FM Polarity**



Select either Normal (default; positive going modulation signal yields negative deviation) or Inverted (positive going modulation signal yields positive deviation) and confirm your setting when prompted.



---

**SETTING FM POLARITY - USING THE FRONT PANEL UI**

To view the FM Polarity screen, select System Settings -> FM Polarity from the Main Menu (see [Figure 2.93](#)).

**Figure 2.93: System Settings - FM Polarity Screen**



Use the up and down buttons to toggle between + Comp = - Freq Dev and + Comp = + Freq Dev. The default setting is + Comp = - Freq Dev. Press the accept (checkmark) button to save the change. Press X to abort the change and return to the previous menu.

---

## SYSTEM SETTINGS - FRONT PANEL UI

**WARNING:**

*System settings are established at Nautel and should not require any adjustment. Making changes to these settings may void your warranty. Contact Nautel before making changes.*

You can establish calibration values and fault thresholds for critical parameters of the VS2.5 using the remote AUI or the local front panel UI. The following options are available:


- [Host Reboot - see page 2-112](#)
- [OS Recovery - see page 2-112](#)
- [Configuring Host Watchdog - see page 2-113](#)
- [Firmware Update - see page 2-114](#)
- [LCD Settings - see page 2-114](#)
- [Calibrating Exciter TCXO - Using the front panel UI - see page 2-108](#)
- [HD Optimizing - Using the front panel UI - see page 2-105](#)
- [Configuring Installed Hardware - see page 2-116](#)
- [Setting FM Polarity - Using the front panel UI - see page 2-110](#)
- [Adjusting Factory Settings - see page 2-118](#)

**Note:**

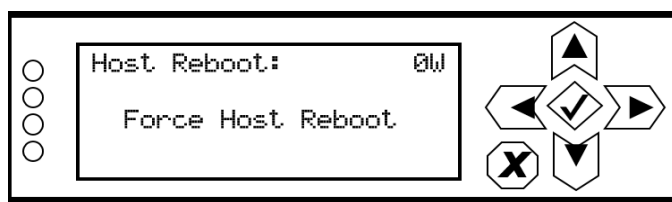
*Changing the console selection in the System Settings -> Console Select menu is not normally required, and should only be performed by trained personnel. Information on this sub-menus is not included in the manual. Contact Nautel for assistance.*

## HOST REBOOT

From the front panel UI, you can reboot the host on the exciter/control PWB. To view the Host Reboot screen, select System Settings -> Host Reset from the Main Menu (see [Figure 2.94](#) on page 2-112).


 **Note:**  
*A host reboot can also be performed from the remote AUI, using the Reboot AUI button on the Reboot page (see [Rebooting the AUI or Exciter - see page 2-100](#)). Once the host is rebooted, all users that were remotely connected (logged in) will be logged out.*

**Figure 2.94: System Settings - Host Reboot Screen**

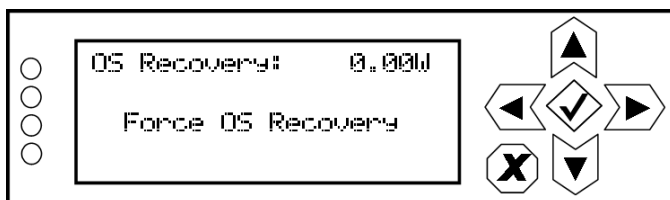


Use the up and down buttons to toggle between Force Host Reboot and Cancel. Press the accept (checkmark) button to save the change. If a reset is selected, it will occur immediately. Select Cancel or press X to abort the reset and return to the previous menu.

## OS RECOVERY

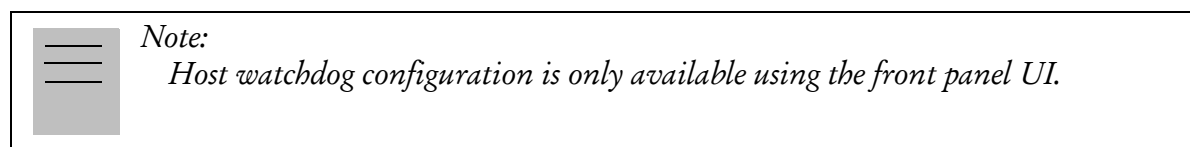
 **Note:**  
*An OS recovery reset can restore the transmitter's operating system. It should only be required if a problem occurs during a software upgrade. This feature is only available using the front panel UI.*

From the front panel UI, you can perform a recovery reset of the operating system (OS). You will also need to install a flash drive, provided by Nautel, in one of the two USB ports on the rear of the transmitter. To view the OS Recovery screen, select System Settings -> OS Recovery from the Main Menu (see [Figure 2.95](#) on page 2-113).

**Figure 2.95: System Settings - OS Recovery Screen**

Use the up and down buttons to toggle between Force OS Recovery and Cancel. Press the accept (checkmark) button to save the change. Select Cancel or press X to abort the recovery and return to the previous menu.

## CONFIGURING HOST WATCHDOG



From the front panel UI, you can enable or disable the host watchdog feature. This feature, when enabled, monitors communication between the ARM processor and the DSP processor on the exciter/control PWB. If communication is lost for more than one minute, the transmitter will initiate an alarm and reboot the host. To view the Host Watchdog screen, select System Settings -> Host Watchdog from the Main Menu (see [Figure 2.96](#)).

**Figure 2.96: System Settings - Host Watchdog Screen**

Use the up and down buttons to toggle between OFF and ON. Press the accept (checkmark) button to save the change. Press cancel (X) to discard changes and return to the previous menu.

## FIRMWARE UPDATE

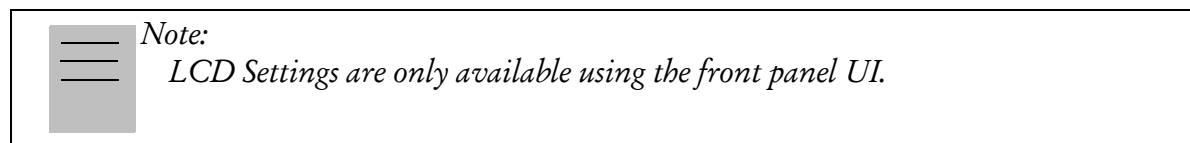
A firmware update is available using the front panel UI. It can also be performed from the remote AUI, using the Upgrade Software page in the System Settings menu (see “[Upgrading Software](#)” on page 2-101). Once the host (SBC) is reset, all users that were remotely connected (logged in) will be logged out.

From the front panel UI, you can update firmware used in the transmitter. To perform a firmware update, select System Settings -> Firmware Update from the Main Menu (see [Figure 2.97](#)).

**Figure 2.97: System Settings - Firmware Update**

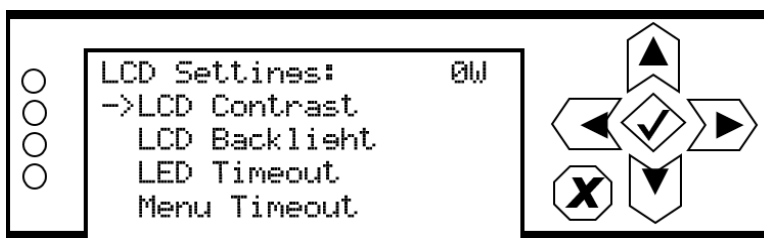


## LCD SETTINGS



From the front panel, you can configure the LCD display's contrast, brightness and backlight settings. To view the LCD Settings screen, select System Settings -> LCD Settings from the Main Menu (see [Figure 2.98](#)).

**Figure 2.98: System Settings - LCD Settings Menu**



This menu has four sub-menu options:

- LCD Contrast - sets the display contrast.
- LCD Backlight - sets the brightness of the display's backlight during normal use.
- LED Timeout - sets a time delay, after a period of non-use, that the brightness of the display's backlight will dim. This feature can also be disabled.
- Menu Timeout - sets a time delay, after a period of non-use, that the front panel screen will revert back to the main menu.

Use the up and down buttons to move the cursor to the desired display setting and then press the right button to enable editing of the setting. [Figure 2.99](#) shows the editing screens for the LCD Settings menu. Within any of the editing screens, use the up and down buttons to edit a setting. Press the accept (checkmark) button to save the change. Press cancel (X) to discard changes and return to the previous menu.

**Figure 2.99: LCD Settings Editing Screens**



Select a value between 50 (lighter contrast) and 200 (darker contrast) (in increments of 5). Press the cancel (X) button to discard changes and return to the previous menu. Default setting is 100.



Select a value between 0 and 100% (in 5% increments). Press the cancel (X) button to discard changes and return to the previous menu. Default setting is 100%.




Select disabled (i.e., no timeout) or select a time period between 0 and 1800 seconds (30 minutes) (in 5 s increments). Press the cancel (X) button to discard changes and return to the previous menu. Default setting is 900 s (15 minutes).



Select a time period between 1 and 60 minutes (in 1 minute increments). Press the cancel (X) button to discard changes and return to the previous menu. Default setting is 10 minutes.

## CONFIGURING INSTALLED HARDWARE

From the front panel UI, you can configure the transmitter for any installed hardware that has optional variations (e.g., quantity of exciters or LVPS modules, fan speed) or is non-standard (e.g., audio processor). To view the HW Config screen, select System Settings -> HW Config from the Main Menu (see [Figure 2.100](#)).

 *Note:*  
*Hardware configuration settings are only available using the front panel UI. These settings are established at the factory based on the configuration that existed at time of shipping. Changes to these setting are only necessary if hardware is added or removed by the user.*

**Figure 2.100: System Settings - HW Config Menu**



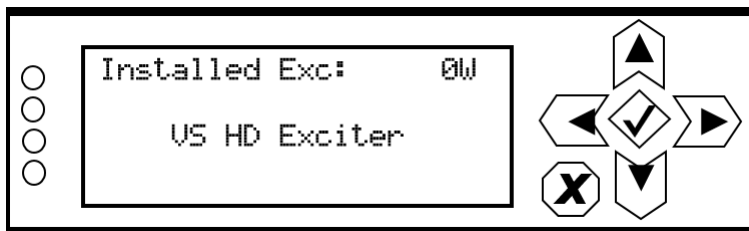
This menu has two sub-menu options:

- [Installed Exciter - see page 2-117](#)
- [Audio Processor - see “Enabling and Operating the Orban Audio Processor” on page 2-184](#)

### INSTALLED EXCITER

From the front panel UI, you can configure the transmitter for the type/location of the installed exciter. To view the Installed Exc screen, select System Settings -> HW Config -> Installed Exc from the Main Menu (see [Figure 2.101](#)).

**Figure 2.101: Installed Exciter Screen**



Use the up and down buttons to select the appropriate exciter configuration - Internal VS Exciter, VS HD Exciter or External FM Exciter. Press the accept (checkmark) button to save the change. Press X to abort the change and return to the previous menu.

- If you select VS HD Exciter, make sure the transmitter has been physically modified to operate with the VSHD exciter (if necessary, refer to the associated modification document IS11005\* to modify and configure the transmitter for operation with a VSHD exciter).



## ADJUSTING FACTORY SETTINGS



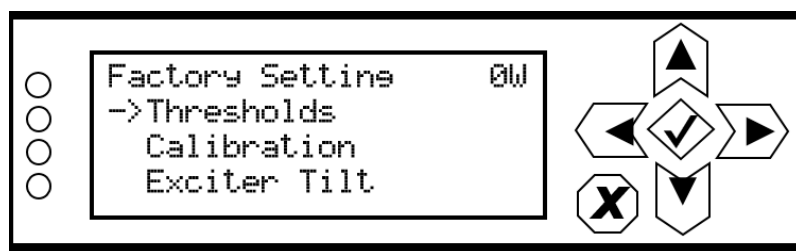
*Note:*

*Factory settings are only available using the front panel UI.*

**CAUTION!** Changing values in the System Settings -> Factory Settings menu is not normally required, and should only be performed by trained personnel. Information on some of these sub-menus is not included in the manual. Contact Nautel for assistance.

From the front panel UI, you can adjust various factory settings such as critical parameter thresholds, calibration values and exciter tilt. To view the Factory Settings menu (see [Figure 2.102](#)), select User Settings -> Factory Settings from the Main Menu.

**Figure 2.102: Factory Settings Menu**



This menu has three sub-menu options:

- [Thresholds](#) - see page 2-119
- [Calibration](#) - see page 2-120 (see IMPORTANT note below)
- [Exciter Tilt](#) - see page 2-122

**IMPORTANT!** The Calibration menu contains a Bias Routine and Exc Att Routine that must be initiated after a new PA PWB has been installed in the transmitter.

## THRESHOLDS



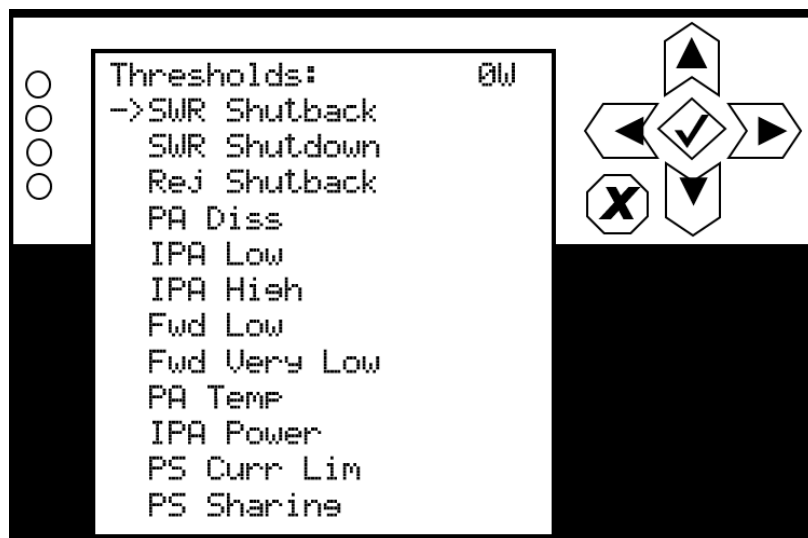
Note:

Threshold settings are only available using the front panel UI.

**WARNING!** Threshold settings are established at the factory and should not require any adjustment. These settings affect critical system protection circuits. Making changes to these settings may void your warranty. Contact Nautel before making changes.

From the front panel UI, you can set alarm thresholds for critical parameters. To view the Thresholds menu (see [Figure 2.103](#)), select System Settings -> Factory Settings -> Thresholds from the Main Menu.

**Figure 2.103: Thresholds Menu**



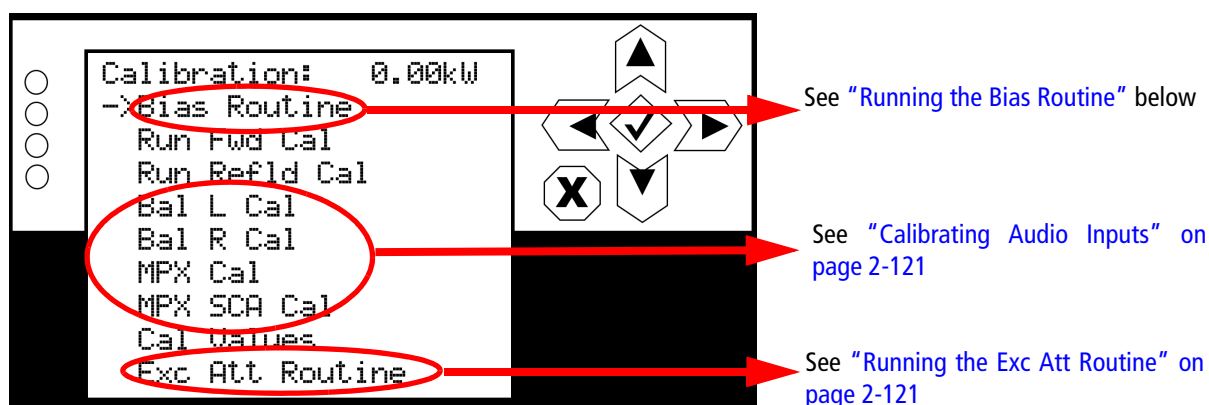
## CALIBRATION

*Note:*

*Most of the calibration settings are only available using the front panel UI. Calibration of audio related parameters (see [Figure 2.104](#)) can also be performed using the remote AUI (see [“Calibrating Audio Inputs”](#) on page 2-102).*

From the controller’s UI, you can calibrate various parameters. To view the Calibration menu (see [Figure 2.104](#)), select System Settings -> Factory Settings -> Calibration from the Main Menu.

**Figure 2.104: Calibration Menu**



**RUNNING THE BIAS ROUTINE.** You must run the transmitter’s bias routine immediately after installation of a new **PA PWB**, or pre-amp/IPA PWB, or exciter/control PWB, or as instructed during alarm troubleshooting.

*Note:*

*Make sure that the RF stage is disabled (RF Off) and the interlock circuit is closed before running the PA bias routine. If not, a message will appear on the display prompting you to do so.*

Use the up or down arrow to place the cursor next to Bias Routine, then press the accept (checkmark) button to enter the sub-menu. In the sub-menu, press the accept (checkmark) button to start the routine. A line will display to indicate the progress. When complete, the display will again read “Press ✓ to begin”. Press X to return to the previous menu.

**CALIBRATING AUDIO INPUTS.** Use the up or down arrow to place the cursor next to the desired audio input calibration item (Bal L Cal, Bal R Cal, MPX Cal or MPX SCA Cal, then press the accept (checkmark) button to enter the selected audio input. With the appropriate calibrated audio source(s) applied, use the up and down arrows to set the new calibration value for the selected audio input. When complete, press the accept (checkmark) button to save the change. Press cancel (X) to discard changes and return to the previous menu.



*Note:*


*Forward power (Run Fwd Cal) and reflected power (Run Refld Cal) calibrations are performed at the factory and should not require user adjustment. Contact Nautel for assistance, if necessary.*

**RUNNING THE EXC ATT ROUTINE.** You must run the transmitter's exciter attenuation routine - with RF enabled (on) and the transmitter operating at the desired output power level - immediately after installation of a new pre-amp/IPA PWB, or exciter/control PWB, or as instructed during alarm troubleshooting.

Use the up or down arrow to place the cursor next to **Exc Att Routine**, then press the accept (checkmark) button to enter the sub-menu. In the sub-menu, press the accept (checkmark) button to start the routine. A line will display to indicate the progress. When complete, the display will again read "Press ✓ to begin". Press X to return to the previous menu.

### EXCITER TILT

From the front panel UI, you can set the exciter tilt settings. To view the Exciter Tilt screen, select System Settings -> Factory Settings -> Exciter Tilt from the Main Menu (see [Figure 2.105](#)).

 *Note:*  
Exciter tilt settings are only available using the front panel UI.

**WARNING!** Exciter tilt settings are established at the factory and should not require any adjustment. Making changes to these settings may void your warranty. Contact Nautel before making changes.

**Figure 2.105: Exciter Tilt Screen**



Use the up or down arrow to place the cursor next to Tilt Opt or Tilt Adjust, then press the accept (checkmark) button to enter the sub-menu. Within the sub-menus, select the desired option or setting and press the accept (checkmark) button to save the setting. Press X to return to the previous menu.

## SETTING USER ACCOUNTS



*Note:*

*This function is only available via remote connection to the AUI.*

Depending on user permissions, you can set up accounts to allow certain users to access and control features of the AUI using the [User Accounts Page](#) - see [Figure 2.106](#). To view the User Accounts page, select User Accounts from the Menu options. Click X in the upper, right corner to close this page, discard changes and return to the home page.



*Note:*

*Depending on the permission level assigned to a given user, some features shown in [Figure 2.106](#) may not be displayed or available.*

The VS2.5 contains a default user account when it leaves the factory. This account appears as Nautel (Auto) in the List of Users and has Administrator permission level. The default Username is “Nautel”. The default Password is blank (i.e., no password). Nautel recommends that you delete this account once you create the desired user account(s) (see [First-Time Login on page 2-125](#)).

**Figure 2.106: User Accounts Page**

The screenshot shows the 'User Accounts : Nautel' window. On the left, the 'Users' list contains 'Joe User', 'Nautel', and 'SNMP\_User'. The 'Settings' section for 'Joe User' is active, displaying a 'User Type' dropdown menu with options: 'Custom', 'View Only', 'Administrator', 'Full Control', and 'Custom'. Below this is a 'Change Password' section with fields for 'Old Password', 'New Password', and 'Confirm Password'. To the right is a 'Permissions' section with checkboxes for 'Activate/Modify Presets', 'Power Control', 'Delete Logs', 'RF On/Off', and 'All other settings'. At the bottom are buttons for 'Add', 'Delete', 'Apply', 'Cancel', and 'Apply Changes'.

## SETTING USER TYPE

There are four user type selection options, each with their own specific functionality. All users have permission to change their own username and password, but are otherwise limited to the following functions:

- **View Only:** Pre-defined user type. Can monitor equipment data only. No administrative or control functions.
- **Administrator:** Pre-defined user type. Can perform all functions. Administrator is the only permission level that allows addition, removal or modification of users.
- **Full Control:** Pre-defined user type. Can monitor and control equipment. No administrative functions.
- **Custom:** Administrator-defined user type.

## EDITING ACCOUNT INFORMATION

If your user type is **Administrator**, you have permissions to edit any user account.

### ADDING AN ACCOUNT

To add a new user account, click **Add**. Enter the username, click the **OK** button to accept, then set the account information in the Settings section. Click the **Cancel** button or **X** to discard changes and exit this menu.

### EDITING AN EXISTING ACCOUNT

To edit an existing user account, click on the desired user in the List of Users on the left side of the User Accounts panel. The Settings for that user will be displayed on the right-hand side of the User Accounts panel. You can edit the Username, Password, User Type (see [Setting User Type](#)) and Permissions.

### CHANGING THE PASSWORD

To change your password, click **Change Password**. A menu appears that prompts you to enter the old password, new password and confirmation of the new password. Click the **OK** button to accept changes or the **Cancel** button to discard changes and exit this menu.

### CHANGING PERMISSIONS

You must be an **Administrator** to edit this function.

All users have permission to change their own username and password. You can customize the permissions assigned to a user or simply pick a predetermined set of permissions based on the user type.

Procedure to change user permissions (see [Figure 2.106 on page 2-123](#)):

1. Open the **User Accounts** page.
2. Select a user from the **Users** list to display the permissions for that user in the center of the **Permissions** window. The permissions associated with the selected user are identified with a checkmark (☑).
3. Press on **User Type** to reveal a drop-down menu and select a new type of user.
4. If the user type in step 3 is **Custom**, set individual permissions. Under **Permissions**, place a checkmark (☑) beside each permission that you want to associate with the user. The boxes work like a toggle - select the checkbox to place a checkmark and select again to remove the checkmark. Choose one or more of the following options:
5. **Activate/Modify Preset** - Allows the user to modify presets and change active preset.
6. **Power Control** - Allows the user to change the power set point of the transmitter..
7. **Delete Logs** - Allows the user to remove log entries.
8. **RF On/Off** - Allows the user to turn the RF output on and off..
9. **All Other Settings** - Allows the user to adjust all settings not mentioned above, except for administrating user accounts.
10. Press **Apply** to assign the new permissions to the selected user.

### REMOVING AN ACCOUNT

To remove a user account, select the desired user from the **List of Users** and click the **Delete** button. A verification prompt will appear. Click the **OK** button to accept changes or the **Cancel** button to discard changes and exit this menu.

To save your changes, click **Apply**.

### FIRST-TIME LOGIN

When you enter the **User Accounts** page for the first time, it is recommended you create an account and then delete the default Nautel account, as follows:

1. Login to the AUI using the default Username (“Nautel”) and Password (blank).
2. Set up your own **Administrator** account, with your desired Username and Password.
3. Logout of the AUI, then login to your new **Administrator** account.
4. Delete the “Nautel” account.



## USER SETTINGS - AUI



**Note:**

Unless otherwise noted, the following functions are only available via remote connection to the AUI.

Network settings can not be edited using the remote AUI. They are for display purposes only. You can only edit network settings using the front panel UI (see [Email Configuration on page 2-128](#)).

You can configure email and notification settings, configure SNMP settings, capture critical transmitter data, enable the use of an external 10 MHz reference, set the system time and date, configure the NTP server (as applicable), and set the station call sign/ID, and set low audio thresholds using the User Settings menu (see [Figure 2.107](#)). To view the User Settings menu, select User Settings from the Menu options. Click X in the upper, right corner to close this page and return to the home page.

**Figure 2.107: User Settings Menu**

The screenshot shows the 'User Settings' window with a sidebar menu on the left and a main configuration area on the right. The sidebar menu includes: Network Setup, Email Configuration, Notifications, Engine Settings, SNMP Configuration, Critical Parameters, External 10MHz, Spectrum Mask, Time Setup, NTP Servers, Nautel Phone Home, Call Sign/ID, and Audio Low Thresholds. The main area is titled 'Network Setup' and contains the following fields:

MAC Address	00:50:C2:59:74:CF
IP Address	10.0.128.182
Subnet Mask	255.255.255.0
Default Gateway	10.0.128.254
Default Nameserver	10.0.1.239
Alternate Nameserver	10.0.1.238
Port Number	3501
Status	Running

At the bottom of the main area are 'Apply' and 'Cancel' buttons. A red 'X' icon is in the top right corner of the window.

Via the User Settings menu, the following configurations are possible:

- **Email Configuration:** Allows configuration of email parameters (e.g., server name, port number, etc.) (see [Email Configuration on page 2-128](#)).


- **Notifications:** Allows configuration of email notifications to be sent for user-selected alarm occurrences (see [Notifications on page 2-130](#)).
- **Exgine Settings:** Allows you to set signal parameters and determine IP information for use with the Exgine option (VSHD only). See [Configuring Exgine Settings - VSHD exciter only on page 2-132](#).
- **SNMP Configuration:** Allows configuration of SNMP settings (see [SNMP configuration on page 2-134](#)).
- **Capture Critical Parameters:** Allows the user to capture critical parameter data for the transmitter's current state and paste it to a spreadsheet program (see [Critical parameters on page 2-136](#)).
- **External 10MHz:** Allows for confirmation of the use of an external 10 MHz reference (see [External 10MHz on page 2-137](#)).
- **Spectrum Mask:** Allows users to select the appropriate FM mask standard (FCC, ETSI or None) being used by the analyzer (see [Spectrum Mask on page 2-139](#)).
- **Time Setup:** Allows for adjustment of the AUI clock's time, date, region and time zone (see [Setting the Clock on page 2-141](#)).
- **NTP Servers:** Allows for configuration and management of NTP servers (see [NTP servers on page 2-144](#)). NTP must be enabled to allow editing; this can only be done using the front panel UI (see [Enabling NTP on page 2-144](#)).
- **Nautel Phone Home:** Provides a unique diagnostic tool that leverages stored transmitter information to assist in the analysis of the cause of specific alarms (see [Nautel Phone Home on page 2-146](#)).
- **Call Sign/ID:** You can set a name that identifies the transmitter on the AUI (see [Setting call sign/ID on page 2-147](#)).
- **Audio Low Thresholds:** Provides adjustable thresholds for low audio [the main audio source and SCA audio source (configurable timeout and trip level)]. See [Setting Audio Low Thresholds on page 2-148](#).

**Note:**

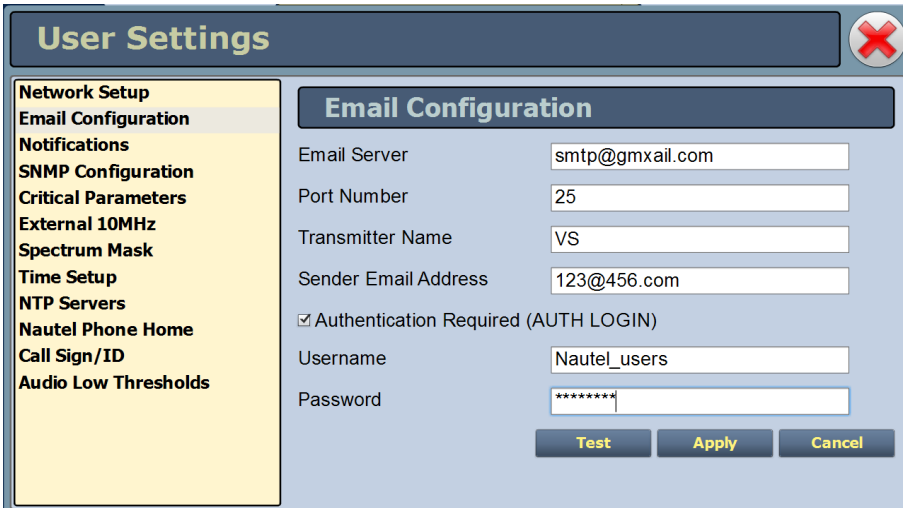
*The front panel UI also has a User Settings menu, which contains similar functions to the AUI (e.g., time setup), and other settings that are described in [User Settings - Front Panel UI on page 2-150](#). Unless otherwise noted, the following functions are only available via a LAN connection to the remote AUI.*

## EMAIL CONFIGURATION

Email configuration (see [Figure 2.108](#)) allows you to configure email parameters (e.g., email server and port number), and is required if the notification feature is used (see [Notifications on page 2-130](#)).

 *Note:*  
*Nautel recommends that the following settings be entered/vetted by a qualified Network Administrator.*

**Figure 2.108: Email Configuration Page**



**All IP addresses shown are for reference purposes only**

To configure the email feature, perform the following steps:

1. Enter the four fields, noting the following:
  - **Email Server:** In order to enter a server name (e.g., mail.nautel.com), at least one nameserver IP address must be entered (see [Email Configuration on page 2-128](#)).
  - **Port Number:** This logical connection end point uses a number to identify the type of process to which an internet or other network message is to be forwarded to when it arrives at a server. Typically, this is set to 25 for unencrypted SMTP systems and 843 for encrypted email.

- **Transmitter Name:** Set to a name that associates to the transmitter such as station identification (e.g., VS\_WXYZ). This name will be included in notification emails.
- **Sender Email Address:** Enter as a standard email address (e.g., a@b.com). This will be the sender address that notification email recipients will see. Free web based email service accounts (Gmail, Hotmail, Yahoo mail etc.) are acceptable here.
- **Authentication Required:** If your email server requires authentication to send emails, click the check box and enter the appropriate **Username** and **Password** to allow this. If the check box is not selected, the **Username** and **Password** fields do not appear.



*Note:*

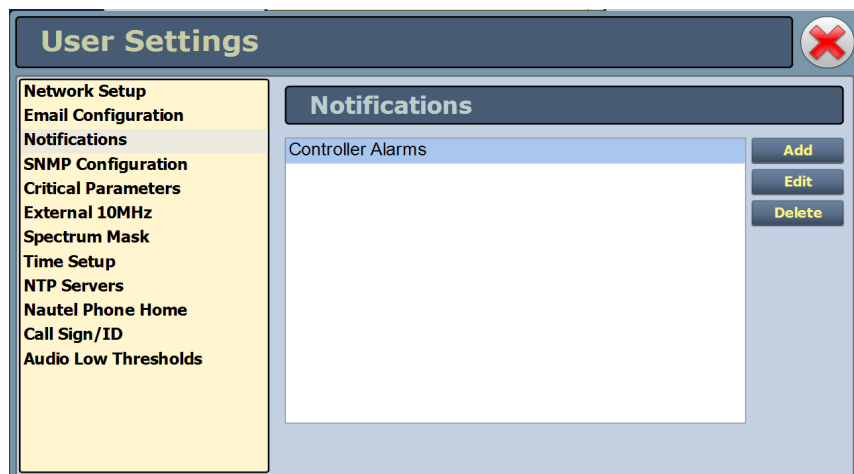
*The transmitter will automatically handle encryption if the associated mail server requires it.*

2. When complete click **Apply** or click **Cancel** to restore the previous setting. Use the **Test** button to enter an email address to test your settings. Click the **OK** button to run the test or the **Cancel** button to return to the **Email Configuration** page.

## NOTIFICATIONS

The notifications feature (see [Figure 2.109](#)) provides a means for the transmitter to issue emails or texts (SMS messages) triggered by user defined alarm events. If you use this feature, you must also configure an email (see [Email Configuration on page 2-128](#)).

**Figure 2.109: Notifications**



To configure the notifications feature, perform the following steps:

1. Pre-existing notifications are displayed in the Notifications list (e.g., "Audio Loss"). Click **Add** to create a new item for notification, click **Update** (after highlighting an existing item) to edit an existing item or click **Delete** to erase an item.
2. When you click **Add** or **Edit**, the screen in [Figure 2.110 on page 2-131](#) will appear. This screen allows you to add or edit a **Notification Name**, **Recipient Email(s)** (use a semi-colon to separate multiple email addresses, as applicable), and define the alarm list by **Device type** (Controller or Exciter). Add or remove alarms by moving them (using the >> and << arrow buttons) from the **Available Alarms** list to the **Selected Alarms** list. An email is issued when any alarm in the **Selected Alarms** list is active.

**Text (SMS) Messaging:** In the **Recipient Email** field, you can enter a standard email address to initiate an email or you can enter a mobile phone number and SMS gateway to initiate a text (SMS message). The email-to-SMS text format is `mobilenumber@mobile_gateway` (e.g., `5551234567@txt.bell.ca`). Check with your mobile carrier to determine the proper gateway address for your area.

3. When complete click the **OK** button to accept changes or the **Cancel** button to discard changes and return to the **Notifications** page.

Figure 2.110: Notifications Adding/Updating

**Notification**

Notification Name

Recipient Email(s)

Device

Available Alarms		Selected Alarms
+1.2V Fail	▶	Discharging PA Volts - Controller
Exciter A Offline		Cutback Active - Controller
External Interlock Open		Audio Loss Summary - Controller
Fan 1 Fail		All Power Amplifiers Inactive - Controller
Fan 2 Fail		ARM Network Down - Controller
Fan 3 Fail		-15V Fail - Controller
Forward Power Limiting		+5V Fail - Controller
Forward Power Low		+3.3V Fail - Controller
Forward Power Shutdown		+15V Fail - Controller
Forward Power Very Low		+1.8V Fail - Controller
High Forward Power	▼	

**OK** **Cancel**

---

## CONFIGURING EXGINE SETTINGS - VSHD EXCITER ONLY

The Engine Settings page allows you to set signal parameters and determine IP information for use with the Engine option (see [Figure 2.111 on page 2-133](#))

Procedure to configure Engine Settings:

1. Open the User Settings page by pressing **Menu/User Settings** on the Home page.
2. Select the **Engine Settings** option (left-side of the screen) to display a list of pre-existing notifications on the right-side of the screen. Press **Refresh** to ensure that the latest Engine configuration information is loaded.
3. Enter the following parameters (if applicable) and press **Apply**.
  - **Digital Carriers** - Select On or Off.
  - **Protocol** - Selects the E2X protocol to use UDP (default) or TCP. Match this setting to the Exporter configuration.
  - **Engine IP, Netmask and Gateway** - Configure the Engine's IP network parameters as assigned by the local network administrator. If no gateway is used or assigned, enter 0.0.0.0.
  - **Exporter IP** - Enter the Exporter's IP address of the interface where the data stream is originating. It is used to filter E2X traffic in case multiple exporters are used in broadcast mode on a single LAN. 0.0.0.0 is also a valid configuration.
  - **E2X Port** - The engine expects E2X on port 9000. Some non-Nautel Exporters utilize port 11000 instead.
  - **Mac Address** - Displays a number that serves as unique network adapter identifier. This is set by the manufacturer and is displayed for informational purposes only. It may be necessary to use this number to allow the AUI to access your network.

Figure 2.111: Engine Settings - with VSHD installed only

**User Settings**

**Engine Settings**

Digital Carriers  On  Off

Protocol  UDP  TCP

Engine IP

Exporter IP

Netmask

Gateway

E2X Port

MAC Address

4. When finished, press **Apply** to accept your entries or press **Cancel** to ignore your changes and exit this window.



## SNMP CONFIGURATION

The SNMP configuration page provides a user with a means to configure the SNMP agent and the associated traps (see [Figure 2.112](#)).

**Figure 2.112: User Settings - SNMP Configuration**

The screenshot shows a web-based configuration window titled "User Settings" with a close button in the top right corner. On the left side, there is a vertical navigation menu with the following items: Network Setup, Email Configuration, Notifications, Engine Settings, **SNMP Configuration** (highlighted), Critical Parameters, External 10MHz, Spectrum Mask, Time Setup, NTP Servers, Nautel Phone Home, Call Sign/ID, and Audio Low Thresholds. The main content area is titled "SNMP Configuration" and contains the following fields and controls:

- Agent Port: Text input field containing "161".
- Read Community: Text input field containing "\*\*\*\*\*".
- Confirm: Text input field containing "\*\*\*\*\*".
- Write Community: Text input field containing "\*\*\*\*\*".
- Confirm: Text input field containing "\*\*\*\*\*".
- Enable Traps: A checkbox that is currently unchecked.

At the bottom right of the main area, there are two buttons: "Apply" and "Cancel".

Configure the SNMP agent as follows:

1. Enter the first five fields, noting the following:
  - **Agent Port:** Enter the UDP port where the SNMP agent checks for requests. The default setting is 161. If your transmitter is behind a firewall, you must open this port to use SNMP.
  - **Read Community:** Enter the password for the SNMP client application to allow acquisition of channel values. Provide confirmation of this password by re-entering it in the Confirm field.
  - **Write Community:** Enter the password for the SNMP client application to allow changing of channel values. Provide confirmation of this password by re-entering it in the Confirm field.

2. Select the **Enable Traps** check box () to allow the SNMP agent to send trap notifications, and to display two additional fields associated with traps. Enter the two additional fields as follows:
  - **Trap Receiver IP:** Enter the IP address of the computer to which the SNMP agent will send trap notifications. The computer must be running an SNMP application that is configured to receive traps. The SNMP agent will send trap notifications to only one recipient.
  - **Trap Receiver Port:** Enter the UDP port where the SNMP agent will send traps. The default setting is 162.
3. When complete press **Apply** or press **Cancel** to restore the previous settings.

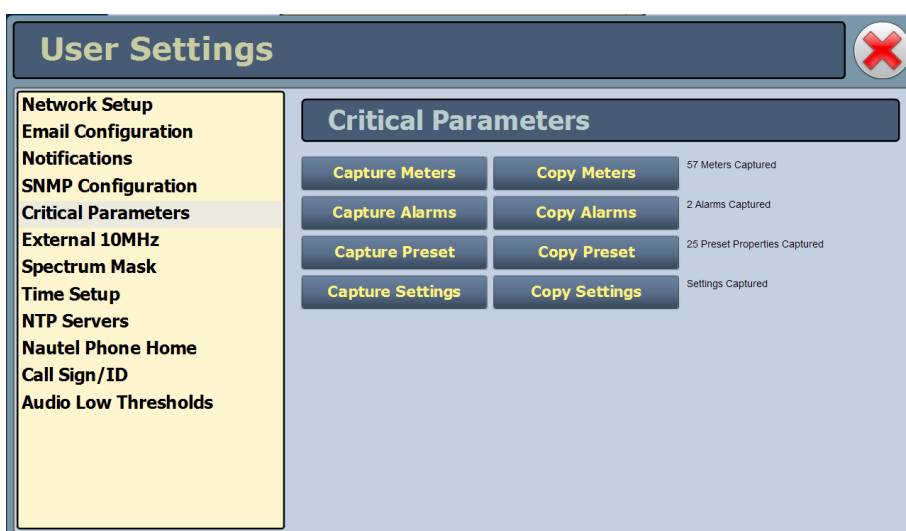
**Note:**

*Check the Read Community and Write Community passwords after a software upgrade. Some upgrades will clear passwords and require them to be reset.*

## CRITICAL PARAMETERS

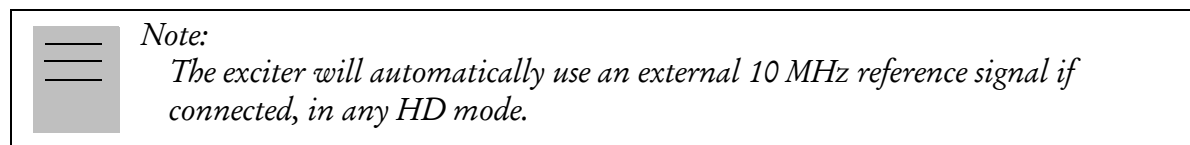
You can capture critical parameter data for the transmitter's current state using the AUI's Critical Parameters page (see [Figure 2.113](#)). To view this page, select Critical Parameters from the User Settings page. From this page, you can press **Capture Meters** (reads all meter values), **Capture Alarms** (reads all active alarms), **Capture Presets** (reads the current active preset) and **Capture Settings** (reads current settings, e.g., active exciter, threshold settings, scale factors, etc.). Once you press the **Capture** button, you can press the associated **Copy** button to copy the data to your computer's clipboard facility. The data copies in a tab-delimited format and is ideally suited for pasting into a spreadsheet program.

**Figure 2.113: User Settings - Critical Parameters**

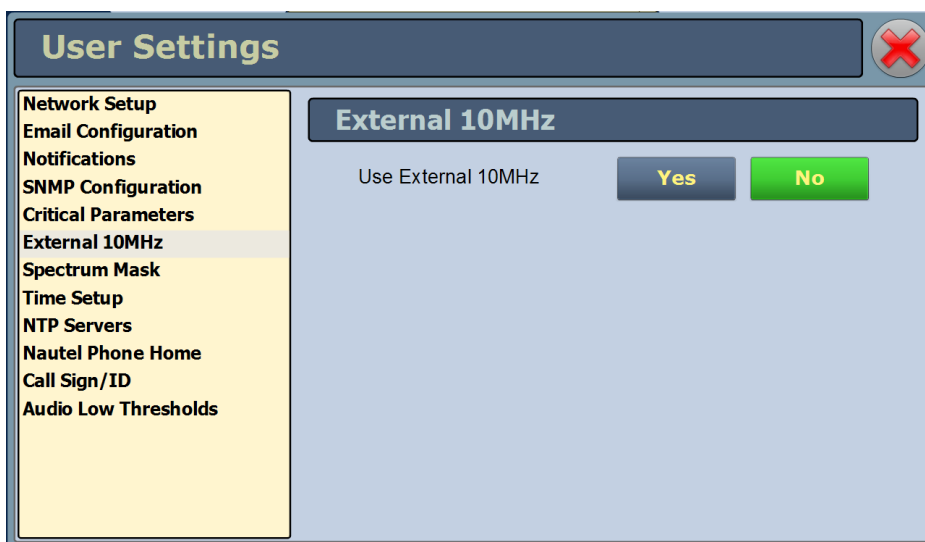


## EXTERNAL 10MHz

This setting (see [Figure 2.114](#)) allows users to employ the clock signal from a connected external 10 MHz source in FM mode; the setting is unused in HD or FM+HD. When **No** is selected, the external 10MHz source will be ignored and the exciter's internal clock signal will be used. If **Yes** is selected, disconnecting the external 10 MHz source will result in constant "No External 10MHz" alarms and logs.



**Figure 2.114: User Settings - External 10 MHz (Default shown)**



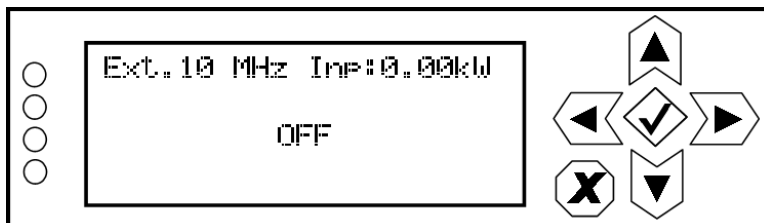
### EXTERNAL 10 MHz INPUT - USING THE AUI

You can view the selection buttons for the external 10 MHz input on the AUI's External 10 MHz screen (see [Figure 2.114](#)) by selecting External 10 MHz from the User Settings options. Yes and No buttons for Use External 10MHz will be displayed. Click Yes if you are using an external 10 MHz signal. Click No if not. Click X in the upper, right corner to close this page and return to the home page.

**EXTERNAL 10 MHz INPUT - USING THE FRONT PANEL**

To view the enable/disable screen for the external 10 MHz input (see [Figure 2.115](#)), select User Settings -> Ext. 10 MHz Inp from the Main Menu.

**Figure 2.115: Front Panel - External 10 MHz Input screen**



Use the up or down arrow to toggle between ON (using external 10 MHz input) and OFF (not using external 10 MHz input), then press the accept (checkmark) button to save the change. Press cancel (X) to discard changes and return to the previous menu.

## SPECTRUM MASK

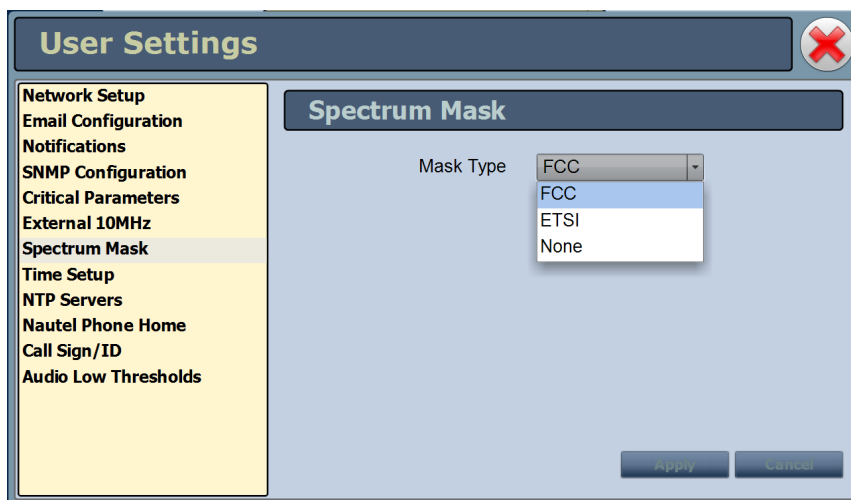
Using the Spectrum Mask setting users can select the appropriate FM mask standard (FCC, ETSI or None) being used by the analyzer. The selection affects the mask lines on the remote AUI's Spectrum Analyzer instrument.

You can select the FM mask standard using the remote AUI (see [Selecting the FM Mask - Using the AUI](#)) or the local front panel UI (see [Selecting the FM Mask - Using the Front Panel on page 2-140](#)). If you change the selection on the front panel UI, it will also be reflected on the remote AUI, and vice versa.

### SELECTING THE FM MASK - USING THE AUI

You can remotely select the FM mask standard using the AUI's Spectrum Mask page (see [Figure 2.116](#)) by selecting Spectrum Mask from the User Settings options.

**Figure 2.116: User Settings - Spectrum Mask**

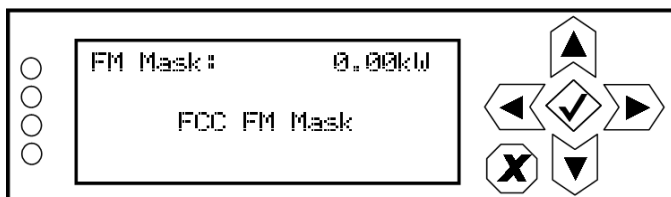


Use the Mask Type pull down menu to select the appropriate mask standard (the factory setting is FCC). Press the Apply button to save the change or press Cancel to discard changes.

### SELECTING THE FM MASK - USING THE FRONT PANEL

When you select User Settings -> FM Mask from the Main Menu (see [Figure 2.117](#)) you can select the appropriate FM mask standard (FCC, ETSI or None) being used by the analyzer on the remote AUI.

**Figure 2.117: FM Mask Screen**



Use the up and down buttons to toggle between FCC FM Mask, ETSI FM Mask and No FM Mask. The factory setting is FCC FM Mask. Press the accept (checkmark) button to save the change. Press cancel (X) to discard changes and return to the previous menu.

## SETTING THE CLOCK

The VS2.5's internal clock uses a backup battery, and therefore maintains an accurate date and time, even during power outages. The date and time needs to be set when the transmitter is first installed, or after a power outage if the backup battery has failed.

You can set the date and time using the remote AUI (see [Setting the Clock - Using the AUI](#)) or the local front panel UI (see [Setting the Clock - Using the Front Panel on page 2-143](#)). If you change the clock setting on the front panel UI, it will also be reflected on the remote AUI, and vice versa. If the NTP feature is enabled (see [Setting the Clock - Using the Front Panel on page 2-143](#)), the clock will set automatically and cannot be manually adjusted.

### SETTING THE CLOCK - USING THE AUI

You can remotely set the VS2.5's time and date using the AUI's Time Setup page (see [Figure 2.118 on page 2-141](#)) by selecting Time Setup from the User Settings options or by clicking on the date or time, which is displayed in the upper, left corner of the AUI.

Figure 2.118: User Settings - Time Setup

The screenshot displays the 'User Settings' window with a sidebar on the left and a main 'Time Setup' panel on the right. The sidebar lists various configuration categories, with 'Time Setup' highlighted. The 'Time Setup' panel contains the following fields and values:

Field	Value
Time	Hour: 14, Min: 45, Sec: 48
Date	Day: 31, Month: Oct, Year: 2013
Timezone	America/Halifax UTC -3:00
Region	Americas
Country	Canada
Zone	America/Halifax Atlantic Time - Nova Scotia (most places), PEI

Buttons for 'Apply' and 'Cancel' are present at the bottom of the Time Setup panel.



The Time Setup option allows users to set the exact time and date information as well as regional and timezone settings for a transmitter location.

Procedure to set up the time and date:

1. Select the Time Setup option from the left-side of the User Settings page to open a related window on the right-side of the page.
2. Enter Time and Date parameters and press Apply. Press Cancel to discard changes. Please note that Time and Date cannot be set via this menu if NTP is enabled (see [Setting the Clock - Using the Front Panel on page 2-143](#)).
  - Time - enter the hour (24-hour clock), minutes (up to 60), and seconds (up to 60).
  - Date - select values from the drop-down menus beside Day, Month, and Year.
3. Enter the following location parameters and press Apply. Press Cancel to discard changes:
  - Timezone - automatically set based on Region, Country and Zone selections.
  - Region - select the appropriate region from the drop-down menu.
  - Country - select the appropriate country from the drop-down menu.
  - Zone - select the appropriate zone from the drop-down menu.



*Note:*

*Changes cannot be made via this menu if NTP is enabled. Disable NTP, make required changes in the Time Setup menu then re-enable NTP (see [“Enabling NTP” on page 2-144](#)).*

The Time Setup page contains editable fields for the time (hours, minutes and seconds), date (day, month and year) and time zone (region, country and zone). The clock is displayed in 24-hour format. Use the drop-down menus to select the desired value for a specific field. Click the appropriate Apply button to accept changes or Cancel to discard them.



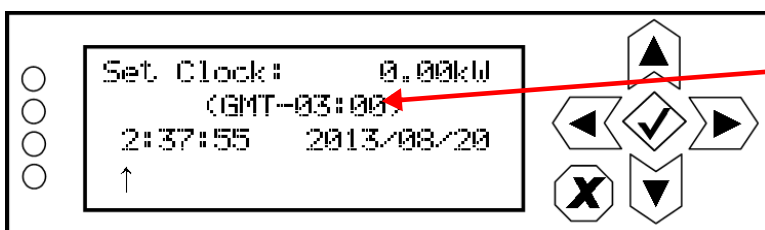
*Note:*

*Ensure the proper Zone is selected to observe Daylight Savings time (DST).*

**SETTING THE CLOCK - USING THE FRONT PANEL**

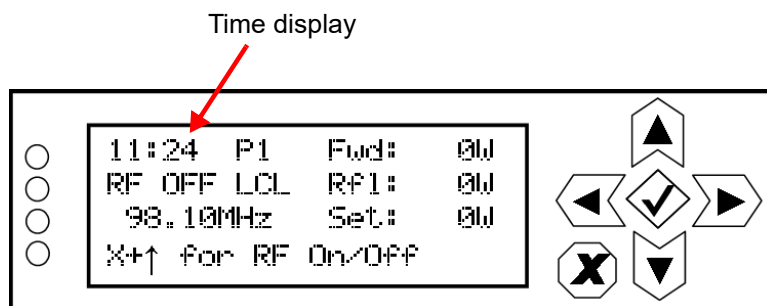
When you select User Settings -> Set Clock from the Main Menu (see [Figure 2.119](#)) you can set the current time and date. The time appears on the top line of the top level screen (see [Figure 2.4 on page 2-10](#)).

**Figure 2.119: Set Clock screen**



**Time zone offset**  
(displayed only if the Timezone is set via the remote AUI)

**Figure 2.120: Time Display on Top Level Screen**



To change the time or date, use the right and left arrow buttons to move the cursor to the desired field (hours, minutes, seconds, year, month, day), and use the up and down arrow buttons to increase or decrease the value of the selected field as desired. When complete, press the accept (checkmark) button to save the change. Press the cancel (X) button to discard changes and return to the previous menu.

**Note:**  
The time zone offset line (e.g., GMT-03:00) (see [Figure 2.119](#)) appears only if the Timezone has been established in the remote AUI's Time Setup page.

## NTP SERVERS

You can configure one or more NTP (Network Time Protocol) servers to allow clock synchronization with all computers on the same network as the transmitter. To view the AUI's NTP Servers page (see [Figure 2.121](#)), select NTP Servers from the User Settings options. There are several functions available on this page - enabling NTP, monitoring NTP server status and managing servers.



Note:

*The accuracy of the NTP synchronization is related to the distance to the server, therefore Nautel recommends you choose servers in the same country as the equipment. If this is not possible, attempt to connect to servers from the same continent.*



Note:

*The NTP clock synchronization polling interval varies between 64 and 1024 seconds. To minimize network traffic, the interval will change depending on how much error is accumulated between polling events and will be increased if the remote NTP server becomes unreachable. The polling interval is also randomized slightly to avoid the situation where a large number of requests are always arriving at the NTP server at the same time.*

**Figure 2.121: User Settings - NTP Servers**

The screenshot shows the 'User Settings' window with the 'NTP Servers' section selected. The 'Enable NTP' checkbox is checked. Below it is a table showing the status of four NTP servers. At the bottom, there is a 'Manage Servers' list with an 'Add' button. A red arrow points from the 'Add' button to a modal dialog titled 'Add NTP Server' which has an input field and 'Ok' and 'Cancel' buttons.

*	Remote	IP	Delay(ms)	Offset(ms)	Jitter(ms)
-	74.3.161.36	140.142.16.34	74.041	-8.207	0.977
+	mirror.mountain	200.98.196.212	29.945	-13.493	1.165
*	time.yike.ca	128.118.25.12	41.282	-16.591	0.977
+	66.96.30.35	206.108.0.133	36.136	-17.270	0.977

Manage Servers

- 0. debian.pool.ntp.org
- 1. debian.pool.ntp.org
- 2. debian.pool.ntp.org
- 3. debian.pool.ntp.org

### ENABLING NTP

Enable the NTP function by selecting the Enable NTP checkbox. Disable by de-selecting the Enable NTP checkbox. Press the Apply button to activate any change.

### MONITORING NTP SERVERS

The NTP Server Status section displays tabular information on the NTP servers connected to the network. The table includes remote name, IP address, delay, offset and jitter.

- **Remote Name:** Displays the host name of the referenced time source. An asterisk (\*) in the first column marks the reference time source that is currently preferred by the NTP daemon. A ‘+’ character in the first column marks high quality candidates for the reference time that could be used if the currently selected reference becomes unavailable.
- **IP:** Displays the IP address associated with the Remote Name. In some cases the Remote Name could be the IP address.
- **Delay:** Displays the round-trip delay (in ms) of the time queries.
- **Offset:** Displays the difference (in ms) between the reference time and the system clock.
- **Jitter:** Displays the magnitude of jitter (in ms) between several time queries.

### MANAGING NTP SERVERS

The Manage Servers section displays the NTP server files that have been added. You can Add to the list of NTP servers or Delete a selected NTP server from the list.

## NAUTEL PHONE HOME

Phone Home is a system developed by Nautel that takes advantage of the vast amount of data collected by Nautel transmitters by proactively sending information to the cloud via the internet once a user enables Phone Home on their transmitter.

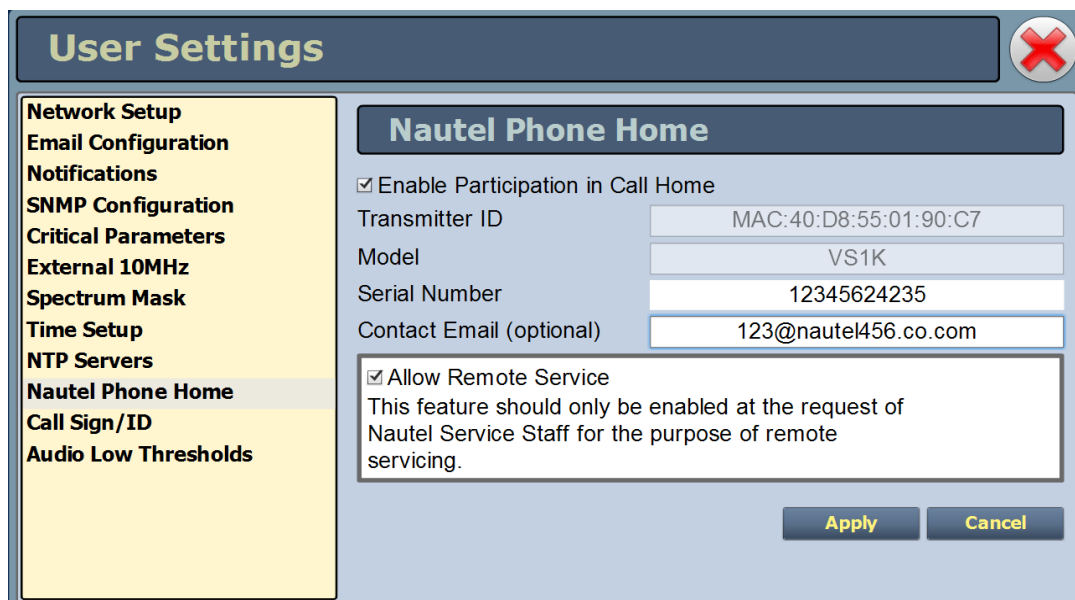
This data includes logs, alarms and meter readings which are then stored in a database and can be analyzed by Nautel staff if an alarm is reported by the transmitter. Since all data is pushed out to Nautel by the transmitter to the cloud, there is no need to reconfigure your firewall and potentially compromise your transmitters security. All data transfers are one way.

Nautel Transmitters are intelligent, collecting data on nearly every aspect affecting your transmitters performance. When this data is used by Nautel customer support staff for diagnostics purposes it cuts down on repair time and gets you back on air faster.

Nautel customer service technicians can use Phone Home to analyze data in real time, even accessing the live AUI, or to view the state of a customer's transmitter at any time leading up to a fault.

This unique diagnostic approach allows Nautel support staff to take a trip back in time and review the events leading up to and during an alarm occurrence, giving customer service technicians valuable insight into how your transmitter is behaving before, during and after an alarm and how this behavior may be related to the alarm event.

**Figure 2.122: Nautel Phone Home**



The screenshot shows a 'User Settings' window with a sidebar on the left containing various configuration categories. The 'Nautel Phone Home' category is selected and highlighted. The main content area is titled 'Nautel Phone Home' and contains the following settings:

- Enable Participation in Call Home
- Transmitter ID: MAC:40:D8:55:01:90:C7
- Model: VS1K
- Serial Number: 12345624235
- Contact Email (optional): 123@nautel456.co.com
- Allow Remote Service

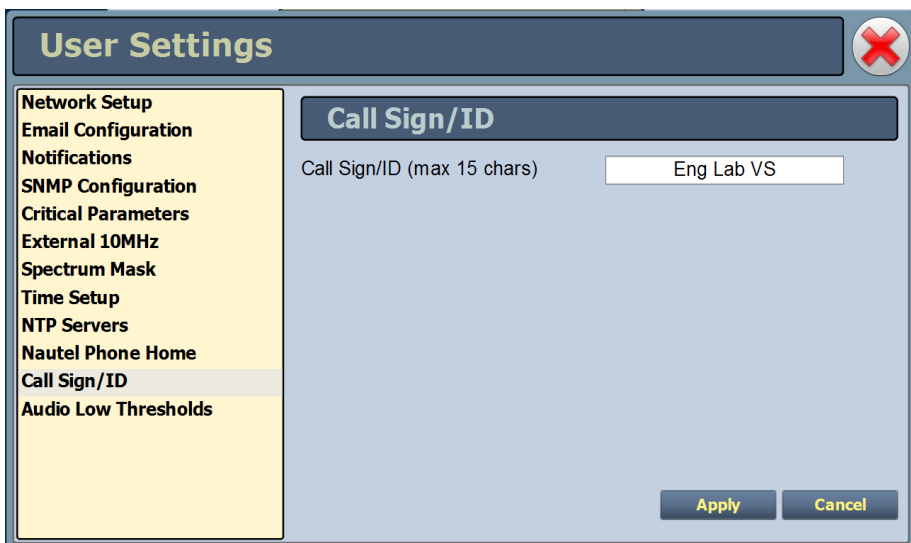
A warning message is displayed below the 'Allow Remote Service' checkbox: 'This feature should only be enabled at the request of Nautel Service Staff for the purpose of remote servicing.' At the bottom right of the window are 'Apply' and 'Cancel' buttons.

## SETTING CALL SIGN/ID

The Call Sign/ID screen (see [Figure 2.123](#)) allows users to set a name that identifies the transmitter on the AUI. This identification will be displayed in brackets on the top transmitter banner of the AUI (see [Figure 2.124](#)).

Enter the call sign or ID in the field and press Apply (maximum 15 characters in length).

**Figure 2.123: User Settings - Call Sign/ID**



**Figure 2.124: Call Sign/ID - Top Banner**



## SETTING AUDIO LOW THRESHOLDS

You can set thresholds for the main audio and SCA sources (trip level and timeout) using the remote AUI (see “[Setting Audio Low Thresholds - using the AUI](#)”) or the front panel UI (see “[Setting Audio Thresholds - Using the Front Panel](#)” on page 2-149). These thresholds determine the limit for an associated low audio power alarm to be activated.

If you change a setting on the remote AUI, it will also change on the front panel UI, and vice versa.

### SETTING AUDIO LOW THRESHOLDS - USING THE AUI

The AUI's Audio Low Thresholds page (see [Figure 2.125](#)) displays a screen that allows for setting of the low trip level and timeout delay for the main audio and SCA audio low thresholds.

**Figure 2.125: User Settings - Audio Low Thresholds Page**

Name	Threshold
Main Audio Low Timeout	5 s
Main Audio Low Trip Level	-22.5 dB
SCA Audio Low Timeout	3 s
SCA Audio Low Trip Level	-16.5 dB

Valid range 0 to 600 s  
Valid range -100 to -3 dB  
Valid range 0 to 600 s  
Valid range -100 to -3 dB

If the applicable audio source (main or SCA) level falls below the Trip Level setting (default is -22.5 dB) for longer than the Timeout setting (default is 20 s), an alarm will activate in the Status and Logs pages.

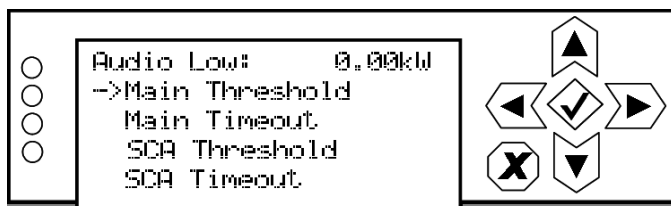
When the audio source level increases above the Trip Level, the alarm will clear. To disable the low audio alarm, set the associated Trip Level to -100 dB. Press Apply to save the change or Cancel to discard changes.

### SETTING AUDIO THRESHOLDS - USING THE FRONT PANEL

When you select User Settings -> Audio Low from the Main Menu (see [Figure 2.126](#)), you can establish the low audio thresholds and timeout delays for the main audio and SCAs.

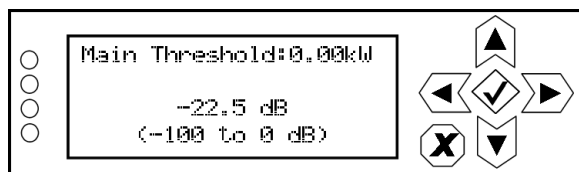
If you change a setting on the front panel UI, it will also change on the remote AUI, and vice versa.

**Figure 2.126: Audio Low Menu**

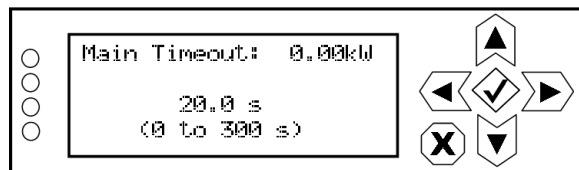


Use the up and down buttons to move the cursor to the desired line item and then press the right button to enable editing. [Figure 2.127](#) shows all possible editing screens for the Audio Low menu. Within any of the editing screens, use the up and down buttons to edit the setting. Press the accept (checkmark) button to save the change. Press cancel (X) to discard changes and return to the previous menu.

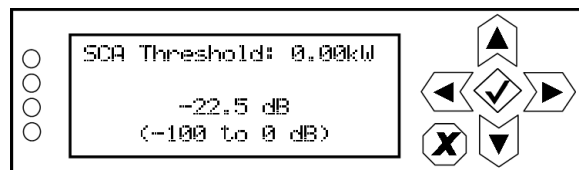
**Figure 2.127: Audio Low Editing Screens**



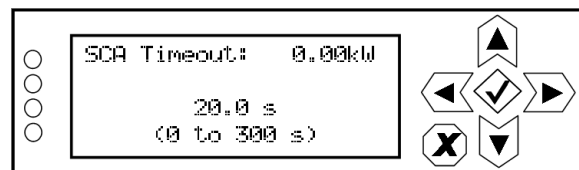
Select a level between -100 and 0 dB (in 0.5 dB increments). Press the cancel (X) button to discard changes and return to the previous menu. Default setting is -22.5 dB.



Select a timeout between 0 and 300 s (5 minutes) (in 0.5 s increments). Press the cancel (X) button to discard changes and return to the previous menu. Default setting is 20 s.



Select a level between -100 and 0 dB (in 0.5 dB increments). Press the cancel (X) button to discard changes and return to the previous menu. Default setting is -22.5 dB.



Select a timeout between 0 and 300 s (5 minutes) (in 0.5 s increments). Press the cancel (X) button to discard changes and return to the previous menu. Default setting is 20 s.



---

## USER SETTINGS - FRONT PANEL UI

You can establish various user settings for the VS2.5 using the local front panel UI. The following options are available:



*Note:*

*The following Front Panel User Settings are also available using the remote AUI and are described in their corresponding remote AUI or stand alone sections:*

*Edit Presets - see [Editing or creating presets on page 2-75](#)*

*Set Clock- see [Setting the Clock - Using the Front Panel on page 2-143](#)*

*Ext. 10MHz - see [External 10 MHz Input - Using the Front Panel on page 2-138](#)*

*Scheduler - see [Enabling the Scheduler - Front Panel on page 2-178](#)*

*FM Mask - see [Selecting the FM Mask - Using the Front Panel on page 2-140](#)*

*Audio Low (thresholds) - see [Setting Audio Thresholds - Using the Front Panel on page 2-149](#)*

- [Network Settings - see page 2-151](#)
- [Network Settings - see page 2-151](#)
- [Signal Generator - see page 2-155](#)
- [Setting Station ID parameters - see page 2-157](#)
- [Setting Low Forward Power Thresholds - see page 2-159](#)
- [Turn-On Delay Setting - see page 2-160](#)
- [Ramp-Up Speed Setting - see page 2-161](#)

---

## NETWORK SETTINGS

**Note:**

*Network settings are only editable using the front panel UI.*

*Nautek recommends that the following network settings be entered/vetted by a qualified Network Administrator. If parameters are changed and the AUI is reset, record the new values (or see the local front panel UI) to ensure you can log in after changes have been made.*

You can configure network settings using the local front panel UI (see [Entering and Editing Network Settings](#)). The remote AUI is a read-only display for network settings. If you change a network setting on the front panel UI, it will be reflected on the remote AUI display.

### DETERMINING DHCP SETTING

One of the main decisions in configuring the network connection on your VS2.5 transmitter is whether you set DHCP to ON or OFF. If you are connecting to a network, consult with a network administrator before connecting the transmitter to your network to determine whether to enable (turn ON) or disable (turn OFF) the DHCP setting.

When DHCP is set to ON (default from factory), IP addresses are assigned automatically by the network server. In order for this feature to function properly, you must have a network-viewable DHCP server on your network.

If a DHCP server is not present, you (or your network administrator) must provide static addresses for IP, netmask, gateway and nameservers (gateway and nameservers are optional). You must enter them manually using the transmitter's front panel. In this case, DHCP should be set to OFF.

### ENTERING AND EDITING NETWORK SETTINGS

From the transmitter's front panel, in local mode, you can set or change network settings. To view the Network Settings screen, select User Settings -> Network Settings from the Main Menu. See [Figure 2.128 on page 2-152](#) for details on setting each parameter.

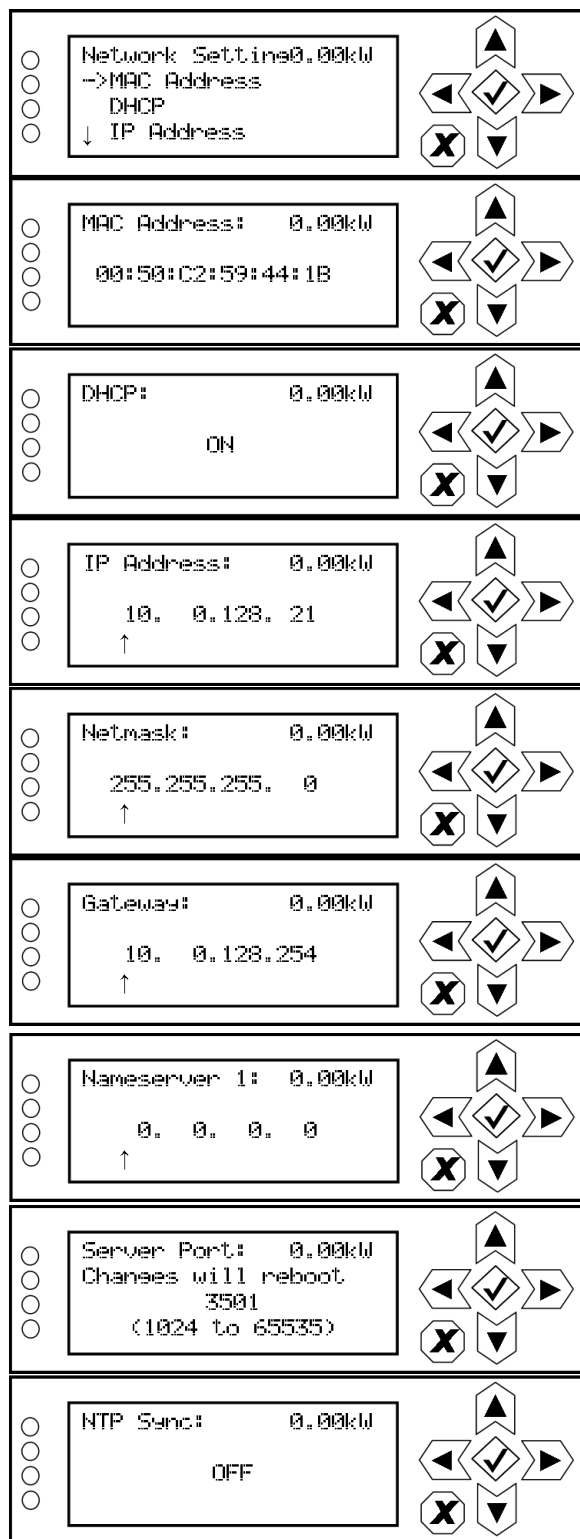
Use the up and down buttons to move the cursor to the desired parameter and then press the right button to enable editing of the setting. Within any of the editing screens, use the left and right buttons to select a character for editing and then use the up and down buttons to edit a setting. Press the accept (checkmark) button to save the change. Press the cancel (X) button to discard changes and return to the previous menu.

**Note:**

*A nameserver (also called a DNS) translates a host name (e.g., mail.nautek.com) to an IP address such as in configuring email (see [Network Settings Screens on page 2-152](#)).*

If you are using a laptop to connect to the VS2.5, see [Connecting a Laptop Directly to the Transmitter on page 2-153](#).

**Figure 2.128: Network Settings Screens**



**All addresses shown are for reference purposes only**

Displays a number that serves as unique network adapter identifier. This is set by the manufacturer and is displayed for informational purposes only (cannot be user set). It may be necessary to use this number to allow the AUI to access your network.

Set to ON to automatically assign the IP Address, Netmask, Gateway, Nameserver 1 and Nameserver 2 by the access point (i.e., a router) or set to OFF to manually assign. In either case, the access point must be configured with the correct settings, which match the settings on the AUI in order for the AUI to access the network.

Displays a unique numerical network identifier for the transmitter. If DHCP was set to OFF, specify the IP address. Consult with your network administrator.

Masks an IP address, and divides the IP address into network address and host address. If DHCP was set to OFF, specify netmask. Typical netmask address shown. Consult with your network administrator.

Denies the address of the network access point. If DHCP was set to OFF, specify the gateway address. Consult with your network administrator.

Address that identifies the DNS host. The DNS (Domain Name System) translates Internet domain and host names to IP addresses. DNS automatically converts the name typed into a web browser address bar to the IP addresses of web servers hosting those sites. If DHCP is set to OFF, specify the address.

Used to identify the senders and receivers of messages. Also supports port forwarding (remapping) which allows the AUI of multiple transmitters to be accessed on the same network. See your network router documentation for additional remapping information and instructions. NOTE: Changes to this port are reset to 3501 after a software upgrade; reconfigured the port, as required, after an upgrade.

NTP = Network Time Protocol.  
Set to ON to allow the network to synchronize to the transmitter time.  
Set to OFF to use the transmitter's internal time reference.

---

### CONNECTING A LAPTOP DIRECTLY TO THE TRANSMITTER

If connecting to the VS2.5 directly with a laptop, you must set a static IP address on the VS2.5 and your laptop.

1. From the front panel UI's **Main Menu**, go to **User Settings -> Network Settings** and set the IP address as follows:
  - DHCP: OFF
  - IP Address: 10.10.10.2
  - Netmask: 255.255.255.0
2. Set the transmitter for **Remote control**.



*Note:*

*The following steps assume the operating system is Windows XP. Adapt as required for computers with different operating systems.*

3. On the laptop, go to **Start Menu/Control Panel/Network Connections/Local Area Network**.
4. In the **Local Area Network Status**, open the **General** tab and choose **Properties**. Scroll down and highlight **Internet Protocol (TCP/IP)**. Choose **Properties**.
5. In the **Internet Protocol (TCP/IP) Properties** window, select **Use the following IP address**.
6. Enter the following settings:
  - IP Address: 10.10.10.1
  - Subnet Mask: 255.255.255.0
  - Default Gateway: 192.168.1.2
7. In the **Internet Protocol (TCP/IP) Properties** window, select **OK**.
8. In the **Local Area Connection Properties** window, select **OK**.
9. In the **Local Area Connection Status** window, select **Close**.
10. Close the **Network Connections** window.

## SETTING PILOT SAMPLE LEVEL

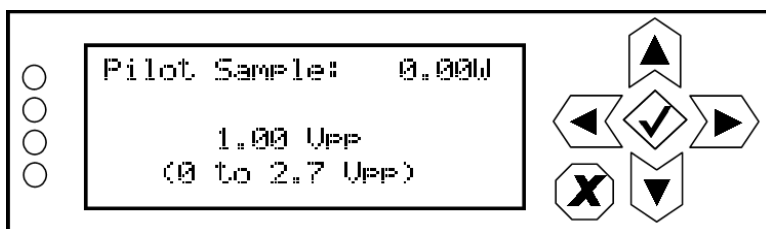


*Note:*

*Setting the pilot sample is only available using the front panel UI.*


From the front panel UI, you can set the level of the sine-wave pilot sample that is applied to the PILOT SAMPLE OUT (A1J4A) BNC connector on the rear of the controller (A4). To view the Pilot Sample screen, select User Settings -> Pilot Sample from the Main Menu (see [Figure 2.129 on page 2-154](#)).

**Figure 2.129: Pilot Sample Screen**



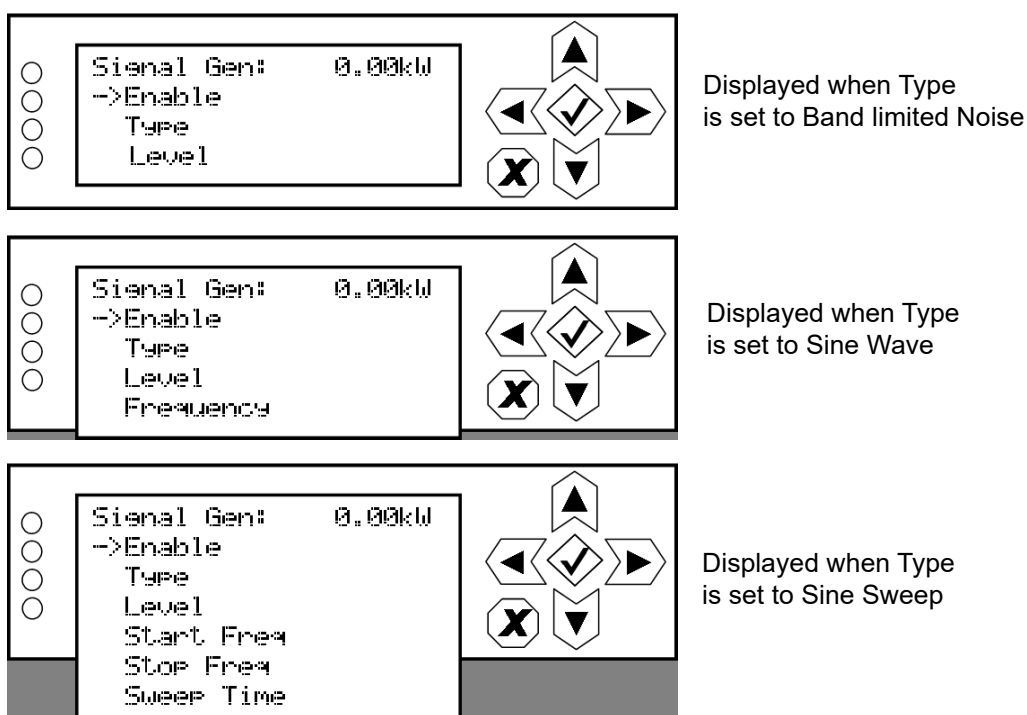
Use the up and down buttons to edit the pilot sample level between 0 and 2.70 V peak-to-peak (in 0.01 V increments). Press the accept (checkmark) button to save the change. Press cancel (X) to discard changes and return to the previous menu.

## SIGNAL GENERATOR

 *Note:*  
Signal Generator is only available using the front panel UI.

From the front panel UI, you can configure the test signal generator output of the VS2.5. Note that a different menu will appear depending on the currently configured test signal type. To view the Signal Gen screen, select User Settings -> Signal Gen from the Main Menu (see [Figure 2.130](#)).

**Figure 2.130: Signal Generator Menus**



Use the up and down buttons to move the cursor to the desired line item and then press the right button to enable editing.

[Figure 2.131 on page 2-156](#) shows all possible editing screens for the Signal Gen menu. Within any of the editing screens, use the up and down buttons to edit the setting. Press the accept (checkmark) button to save the change. Press cancel (X) to discard changes and return to the previous menu.

**Figure 2.131: Signal Generator Editing Screens**

	<p>Select ON (enabled) or OFF (disabled). Press the cancel (X) button to discard changes and return to the previous menu. Default is OFF.</p>
	<p>Select a type - None, Sine Wave, Sine Sweep or Band limited Noise. Press the cancel (X) button to discard changes and return to the previous menu.</p>
	<p>Select a level between 0 and 100%. Press the cancel (X) button to discard changes and return to the previous menu. Default is 100%.</p>
	<p>When Type is set to Sine Sweep or Sine Wave, select a start frequency between 0 and 20 kHz. Press the cancel (X) button to discard changes and return to the previous menu. Default is 1 kHz.</p>
	<p>When Type is set to Sine Sweep, select a stop frequency between 1 and 20 kHz. Press the cancel (X) button to discard changes and return to the previous menu. Default is 1 kHz.</p>
	<p>When Type is set to Sine Sweep, select a time between 0 and 60 s. Press the cancel (X) button to discard changes and return to the previous menu. Default is 30 s.</p>

## SETTING STATION ID PARAMETERS

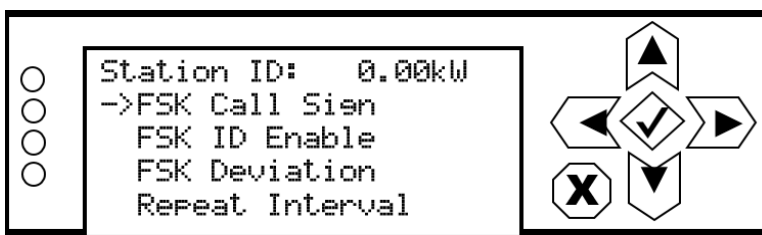


*Note:*

*Station ID settings are only available using the front panel UI.*

In certain applications, the VS2.5 may be used as a translator to re-broadcast primary information as a secondary station on an alternate frequency. To allow the secondary station to be identified, you can set station ID parameters such as call sign, FSK deviation and repeat interval. To view the Station ID screen, select User Settings -> Station ID from the Main Menu (see [Figure 2.132](#)).

**Figure 2.132: Station ID Menu**



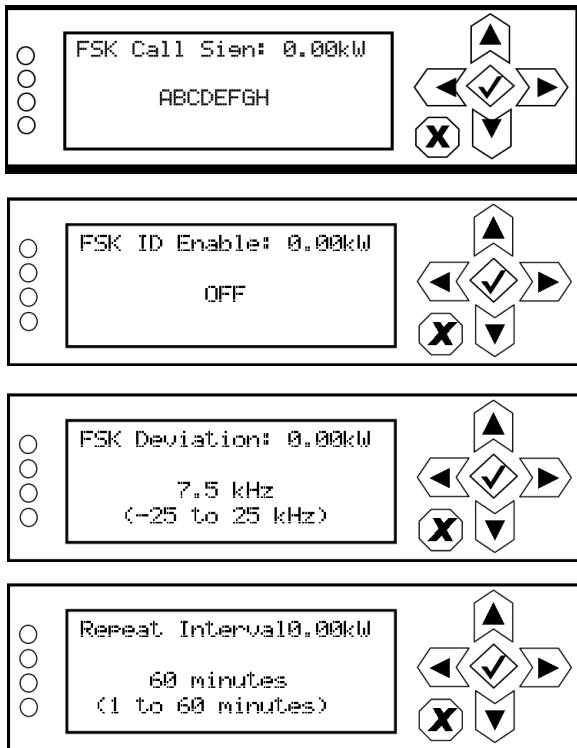
This menu has four sub-menu options:

- FSK Call Sign - sets the station's call sign letters.
- FSK ID Enable - enables (ON) or disables (OFF) the station ID feature.
- FSK Deviation - sets the amount of carrier shift from the original carrier frequency. Select a value between -25 kHz and +25 kHz.
- Repeat Interval - determines how often the call sign is broadcast using FSK (recommended at least once per hour). Select a value between 1 and 60 minutes.

Use the up and down buttons to move the cursor to the desired display setting and then press the right button to enable editing of the setting. [Figure 2.133 on page 2-158](#) shows the editing screens for the Station ID menu. Within any of the editing screens, use the up and down buttons to edit a setting. In the FSK Call Sign editing screen, use the left and right buttons to select a character for editing. Press the accept (checkmark) button to save the change. Press cancel (X) to discard changes and return to the previous menu.



Figure 2.133: Station ID Editing Screens



## SETTING LOW FORWARD POWER THRESHOLDS

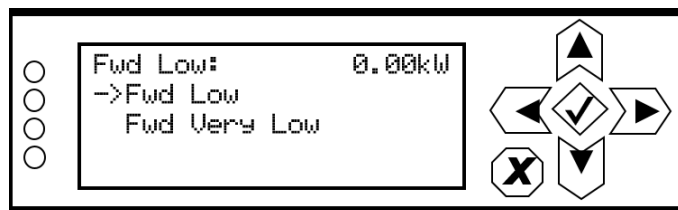


*Note:*

*Low forward power settings are only available using the front panel UI.*

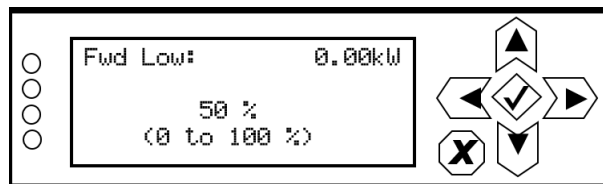
When you select User Settings -> Fwd Low from the Main Menu (see [Figure 2.134](#)), you can establish the low forward power thresholds for the VS2.5. There are two thresholds available - low power and very low power.

**Figure 2.134: Fwd Low Menu**

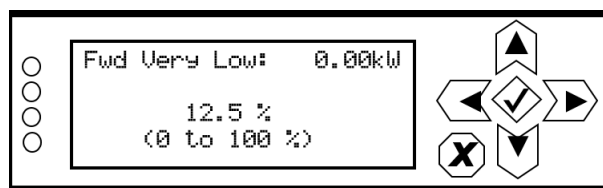


Use the up and down buttons to move the cursor to the desired line item and then press the right button to enable editing. [Figure 2.135](#) shows the two editing screens for the Fwd Low menu. Within either of the editing screens, use the up and down buttons to edit the setting. Press the accept (checkmark) button to save the change. Press cancel (X) to discard changes and return to the previous menu.

**Figure 2.135: Fwd Low Editing Screens**

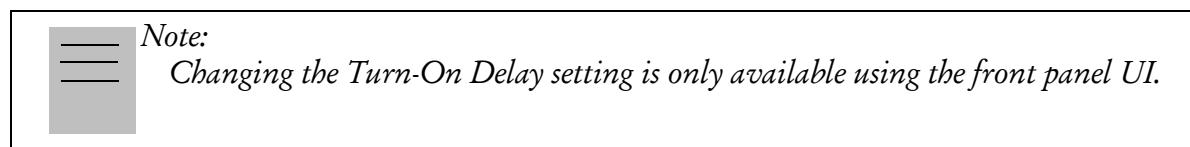


Select a threshold between 0 and 100% (in 0.5% increments), that corresponds to a percentage of rated power. Press the cancel (X) button to discard changes and return to the previous menu. Default setting is 50% (equivalent to 3 dB power reduction).



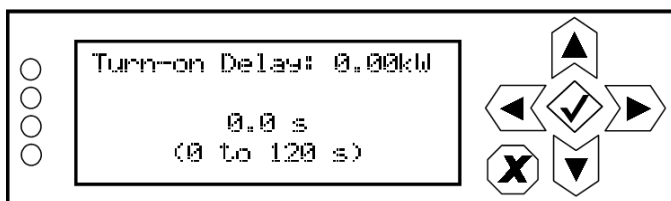
Select a threshold between 0 and 100% (in 0.5% increments), that corresponds to a percentage of rated power. Press the cancel (X) button to discard changes and return to the previous menu. Default setting is 12.5% (equivalent to 9 dB power reduction).

## TURN-ON DELAY SETTING



From the front panel UI, you can set the transmitter's turn-on delay. This setting determines the time delay for the transmitter to recover from an ac power loss. This is typically used in sites with multiple transmitters on a common generator. By staggering the turn-on delay periods of each transmitter, you can reduce the overall load on the generator. To view the Turn On Delay screen, select User Settings -> Turn On Delay from the Main Menu (see [Figure 2.136](#)).

**Figure 2.136: Turn On Delay Screen**



Use the up and down buttons to select a delay between 0 and 120 s (in 1 s increments). The default setting is 0 s (disabled). Press the accept (checkmark) button to save the change. Press X to abort the reset and return to the previous menu.

## RAMP-UP SPEED SETTING



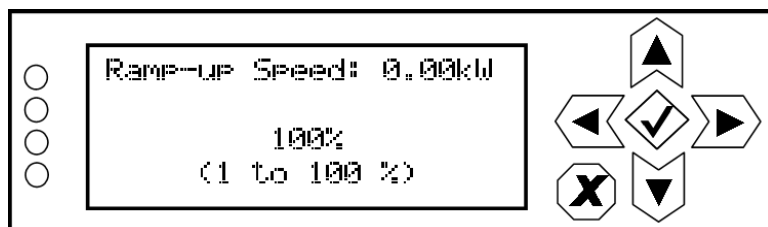
*Note:*

*Changing the Ramp-Up Speed setting is only available using the front panel UI.*

From the front panel UI, you can set the transmitter's ramp-up speed. This setting establishes the time it takes the transmitter to ramp up from 0 W to full power. At 100%, ramp-up speed is approximately seven seconds. For a setting of 50%, ramp-up would be approximately 14 seconds. For a setting of 25%, ramp-up would be approximately 28 seconds. In multi-transmitter systems that are on a common generator or power grid, adjusting the ramp-up speed can be used to reduce the transient load on the source during an ac power recovery (i.e., after a power failure or changeover to a generator).

To view the Ramp-up Speed screen, select User Settings -> Ramp-up Speed from the Main Menu (see [Figure 2.137](#)).

**Figure 2.137: Ramp-up Speed Screen**



Use the up and down buttons to select a ramp-up speed between 1 and 100% (in 1% increments), noting 100% represents approximately seven seconds (0 W to full power). The default setting is 100%. Press the accept (checkmark) button to save the change. Press X to abort the reset and return to the previous menu.

## CONFIGURING REMOTE INPUTS AND OUTPUTS

**Note:**

*This function is only available via remote connection to the AUI. However, you can view the status of remote inputs and outputs on the front panel display.*

You can configure your remote input/output interface for the transmitter using the remote AUI (see [Remote I/O Settings - Using the AUI](#)) or using the local front panel UI (see [Remote I/O Settings - Using the Front Panel UI on page 2-172](#)).

Refer also to the VS2.5 Pre-installation Manual for information on remote inputs and outputs and their factory default settings.

### REMOTE I/O SETTINGS - USING THE AUI

To view the Remote I/O page (see [Figure 2.138](#)), select Remote I/O from the Menu options. Click X in the upper, right corner to close this page and return to the home page.

**Figure 2.138: Remote I/O Page (Remote Inputs tab shown)**



Select the Remote Inputs (see [Remote Inputs - AUI on page 2-163](#)) or Remote Outputs (see [Remote outputs - AUI on page 2-165](#)) tab to view or edit detail on the remote inputs or outputs.

---

## REMOTE INPUTS - AUI

Using the Remote Inputs tab (see [Figure 2.138 on page 2-162](#)), you can configure up to 10 remote inputs that allow you to remotely control various operational characteristics of the transmitter. Unless otherwise noted, these inputs are only accepted by the transmitter if the remote/local status is set to remote.

Nautel sets remote input defaults prior to shipping. See the VS2.5 Pre-installation Manual for details.

Select the desired remote input (1 through 10) from the list. The Channel and Control settings for the selected input, as well as the current logic level (1 or 0), are displayed on the right-hand side of the page. You can define the Channel and Control settings as follows:

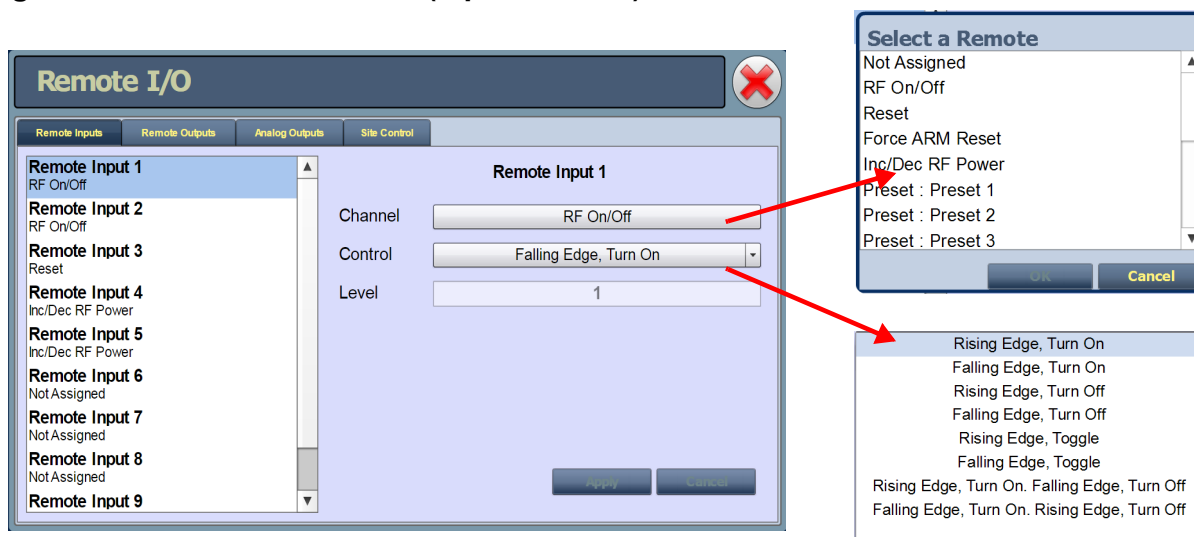
### SELECT INPUT CHANNEL - AUI

You can configure remote inputs 1 through 10 for one of a variety of control inputs. Click the existing Channel bar to display the Select a Remote window (see [Figure 2.139 on page 2-164](#)). From this window select one of the following options by clicking OK:

- **Not Assigned.** No effect on transmitter operation, regardless of logic level.
- **RF On/Off.** Same as pressing the RF On (telling the system to provide RF power, if possible) or the RF Off button on the local AUI. There are 2 inputs configured by default; one for Falling Edge, Turn On and one for Falling Edge, Turn Off.
- **Reset.** Causes a system reset. Same as pressing Reset button on the bottom banner.
- **Force Host Reset.** Allows the user to force a host (SBC) reset to the AUI, thus rebooting the AUI via a hardware parallel remote input (controlled by a third party remote control unit).
- **Inc/Dec RF Power.** Activating these inputs will increment/decrement the preset power level by a fixed amount (1% of rated power).
- **Preset: NAME.** Selects the associated preset (from a list of all pre-defined presets) as active.

If you save a change to a remote input via the remote AUI, it will also be displayed on the front panel UI screen.

Figure 2.139: Select a Remote (input window)



### CONFIGURE INPUT CONTROL LOGIC - AUI

You can configure the active/inactive control logic for each of the 10 remote inputs. Click the existing Logic bar to display the applicable drop-down menu options, which may include:

- Rising Edge Turn On/Reset. Logic '1' (high or rising edge) activates the input (or causes a reset, as appropriate).
- Falling Edge Turn On/Reset. Logic '0' (low or trailing edge) activates the input (or causes a reset, as appropriate).
- Rising Edge Turn Off. Logic '1' (high or rising edge) de-activates the input.
- Falling Edge Turn Off. Logic '0' (low or trailing edge) de-activates the input.
- Falling Edge Toggle. Logic '0' (low or trailing edge) de-activates the input; next logic '0' (low or trailing edge) activates the input.
- Rising Edge Toggle. Logic '1' (high or rising edge) activates the input; next logic '1' (high or rising edge) de-activates the input.
- Rising Edge, Turn On. Falling Edge Turn Off. Logic '1' (high or rising edge) activates the input; logic '0' (low or trailing edge) de-activates the input.
- Falling Edge, Turn On. Rising Edge Turn Off. Logic '0' (low or trailing edge) activates the input; logic '1' (high or rising edge) de-activates the input.
- Active High, Increase. Logic '1' (high) causes a power increase.
- Active Low, Increase. Logic '0' (low) causes a power increase.

- Active High, Decrease. Logic '1' (high) causes a power decrease.
- Active Low, Decrease. Logic '0' (low) causes a power decrease.

Click Apply to activate changes. Click Undo to cancel changes.

## REMOTE OUTPUTS - AUI

Using the [Remote Outputs Page](#) - see [Figure 2.140](#), you can configure up to 16 remote outputs that indicate either the presence of various alarms or the status of operator controlled circuits.

Nautel presets the remote outputs prior to shipping. See the *VS2.5 Pre-installation Manual* for details.

**Figure 2.140: Remote Outputs Page**



Select the desired remote output (1 through 16) from the list. The Channel and Logic settings for the selected output, as well as the current logic level (1 or 0), are displayed on the right-hand side of the page. You can define the Channel and Logic settings as follows:

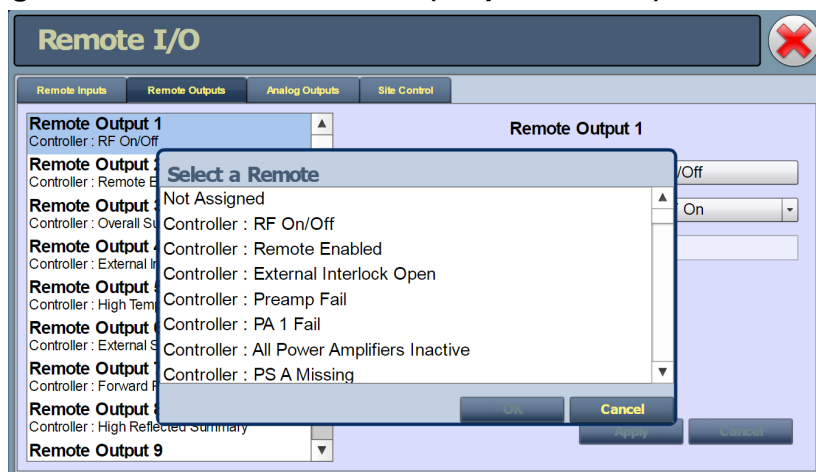


### SELECT OUTPUT CHANNEL - AUI

You can configure remote outputs 1 through 16 to monitor a variety of alarm and status outputs. Click the existing Channel bar to display the Select a Remote window (see . From this window, select one of the channels, then click Load to accept:

- **Not Assigned.** No alarm or status parameter is monitored.
- **RF On/Off.** The active logic level indicates the transmitter's RF power stage is on (enabled). The inactive logic level indicates the transmitter's RF power stage is off.
- **Remote Enabled.** An active logic low level indicates remote control is enabled (i.e. local plus remote). The inactive logic level indicates remote control is disabled.
- **Various Alarms.** The active logic level indicates that the selected alarm is occurring. Any transmitter alarm can be selected as a remote output. Refer to the *VS2.5 Troubleshooting Manual* for a description of each alarm.
- **Preset Status (1-4 default).** The active preset's output will be indicated by a logic low. The remaining, non-active preset outputs will be open collector.

**Figure 2.141: Select a Remote (output window)**



### CONFIGURE OUTPUT CONTROL LOGIC - AUI

You can configure the active/inactive logic for each of the 16 remote outputs. Click the existing Logic bar to display the applicable drop-down menu options. Some remote output default examples:

if the selected channel is RF On/Off, the drop-down options are:

- **Output Low When RF On.** Logic '0' (low) indicates the output is true (RF is on); Logic '1' (high) indicates the output is false (RF is off).
- **Output Low When RF Off.** Logic '0' (low) indicates the output is true (RF is off); Logic '1' (high) indicates the output is false (RF is on).

if the selected channel is **Local/Remote**, the drop-down options are:

- **Output Low When Local.** Logic '0' (low) indicates the output is true (Local); Logic '1' (high) indicates the output is false (Remote).
- **Output Low When Remote.** Logic '0' (low) indicates the output is true (Remote); Logic '1' (high) indicates the output is false (Local).

if the selected channel is **Preset: Preset 1**, the drop-down options are:

- **Output Low When Active.** Logic '0' (low) indicates the output is true (Active); Logic '1' (high) indicates the output is false (Inactive).
- **Output Low When Inactive.** Logic '0' (low) indicates the output is true (Inactive); Logic '1' (high) indicates the output is false (Active).

if the selected channel is **Modulation Loss**, the drop-down options are:

- **Output Low When True.** Logic '0' (low) indicates the output is true (True); Logic '1' (high) indicates the output is false (False).
- **Output Low When False.** Logic '0' (low) indicates the output is true (False); Logic '1' (high) indicates the output is false (True).

Click **Apply** to activate changes. Click **Undo** to cancel changes.

## ANALOG OUTPUTS

There are four analog outputs - forward power, reflected power, average PA voltage and total PA current - that can be remotely monitored (see [Figure 2.142](#)). These outputs are factory defined parameters (cannot be changed to other parameters), however their scaling can be configured to reflect the output voltage that yields a full-scale deflection.

The values associated with each of these fixed meters are of a linear nature so that changes made to the **Sample Full Scale** field (allowable range is 1- 6 V, defaulted to 6 V) will be reflected in the other fields according to the following equation:

$$(\text{Meter Value}/\text{Meter Full Scale}) \times \text{Sample Full Scale} = \text{Sample Voltage}$$



*Note:*

*The Sample Voltage reading reflects the value that can be measured at the associated remote analog output pin for the given Meter Value. See the VS series transmitter Pre-installation Manual for actual remote analog output pin assignments.*

Press Apply to activate changes. Press Cancel to discard changes.

**Figure 2.142: Analog Outputs**

Name	Sample Full Scale	Meter Full Scale	Sample Voltage	Meter Value
1 Forward Power	6.000 V	400 W	0.000 V	0 W
2 Reflected Power	6.000 V	40 W	0.000 V	0 W
3 Average PA Voltage	6.000 V	60 V	0.084 V	0.847 V
4 Total PA Current	6.000 V	15 A	0.000 V	0 A

## SITE CONTROL SETTINGS

You can use the AUI's Site Control page (see [Figure 2.143](#)) to locally or remotely configure remote inputs and outputs for use with external site control equipment (air conditioner, etc.). This page allows the user to create and configure custom inputs and outputs and assign them for use using the Remote Inputs and Remote Outputs pages.

To view this page, select Remote I/O from the Menu options and select the Site Control tab. Press X in the upper, right corner to close this page and return to the Home page.

**Figure 2.143: Remote I/O Page - Site Control**

Name	Severity	Latch	Log	Delay	Triggered When	State
Test	Low	<input type="checkbox"/>	<input checked="" type="checkbox"/>	Immediate	Controller:Test Is True	<input checked="" type="checkbox"/>

### ADDING OR EDITING A SITE CONTROL RULE

Selecting the Add or Edit button displays the rule editing window (see [Figure 2.144](#) on page 2-170) for site control inputs and outputs. This window allows you to create a new site control rule or edit an existing one. Each custom input or output can be assigned a name, severity level and trigger parameters (active state and time delay). Each rule can also be set to latch (i.e., requiring a reset) or log with the rest of the transmitter's alarm and status signals, upon its occurrence. You can use Boolean logic expressions to perform 'AND', 'OR' and 'XOR' (exclusive OR) functions on multiple inputs or rules.

Use the Edit Site Control Rule window as follows:

**Figure 2.144: Site Control Rule Editing Window**

The screenshot shows the 'Edit Site Control Rule' dialog box. The background is a table with columns: Severity, Latch, Log, Delay, and Triggered When. The rule being edited is 'High Temp (Air Cond On)' with Severity: Medium, Latch: unchecked, Log: unchecked, Delay: Immediate, and Triggered When: Controller()PS A Over Temperature Is True OR Controller()PA Over Temperature Is True. The dialog box contains the following fields:

- Name: High Temp (Air Cond On)
- Severity: Medium (dropdown)
- Delay: Immediate (dropdown)
- Latch:
- Log:
- Input fields:
  - Controller : PSA Over Temperature (dropdown)
  - Controller : PA Over Temperature (dropdown)
- Logic fields:
  - Is True (dropdown)
  - Is True (dropdown)
- Operator: OR (dropdown)
- Buttons: Apply, Cancel

- In the Name section, enter a name for the rule. This will display on the Site Control page, as well the Logs page, when triggered.
- In the Severity section, use the drop-down menu to select Low, Medium or High. The selected severity level will display on the Status page and Events Log. See [Figure 2.14 on page 2-27](#) for a description of the severity levels for logged events.
- In the Delay section, use the drop-down menu to select the time delay after activation that the site control rule will take effect (i.e., be asserted). Select Immediate, 1 Sec, 2 Sec, 5 Sec, 10 Sec, 30 Sec or 60 Sec.
- Check the Latch check-box if you want the assertion of the rule to require a reset. If not, leave the box unchecked.
- Check the Log check-box if you want the assertion of the rule to display an alarm and log the event. If not, leave the box unchecked.

- In the **Input** section, use the drop-down menu to select the desired input (alarm, status or custom input) that will affect the rule. Note that a second input may also be selected in conjunction with a logic operation if the **Operator** section contains the AND, OR or XOR function.
- In the **Logic** section, use the drop-down menu to select “Is True” or “Is False” to indicate the trigger for the assertion of the rule. Select “Is True” when you want the rule to assert when the associated input is active. Select “Is False” when you want the rule to assert when the associated input is inactive.
- In the **Operator** section, use the drop-down menu to select a logic operation to combine two inputs. Select “blank” for no logic operation (i.e., for single input rules). For rules that use two inputs, select AND, OR or XOR, noting:
  - the AND function requires both inputs to be asserted (according to their selected Logic states) to activate the rule.
  - the OR function requires one or both inputs to be asserted (according to their selected Logic states) to activate the rule.
  - the XOR function requires one - and only one - input to be asserted (according to their selected Logic states) to activate the rule.
- Press the **Apply** button to save the rule or the **Cancel** button to return to the **Site Control** page.

The **Site Control** page will display all rules, with the user-defined characteristics described above. Additionally, the current **State** of the rule will be displayed in a check-box on the right-hand side of the page. A checked box indicates the rule is currently active.

#### USING SITE CONTROL FEATURES WITH REMOTE INPUTS AND OUTPUTS

You can apply a site control rule as a **Remote Output** by selecting the desired rule from the **Channel** list in the **Remote Outputs** tab. The **Channel** list should contain the names of all existing rules. See [“Remote I/O Settings - Using the AUI” on page 2-162](#) for more details on configuring remote inputs and outputs.

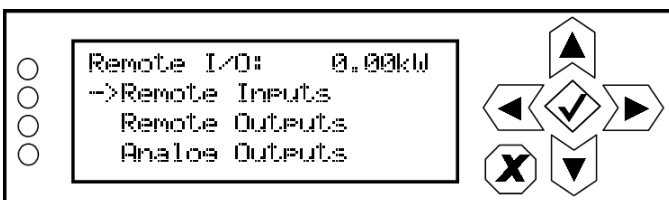
Custom remote inputs can be created in the **Remote Inputs** tab. These inputs can be used within a site control rule.

---

## REMOTE I/O SETTINGS - USING THE FRONT PANEL UI

To view the Remote I/O screen (see [Figure 2.145](#)) on the front panel display, select User Settings -> Remote I/O from the Main Menu.

**Figure 2.145: Remote I/O screen**

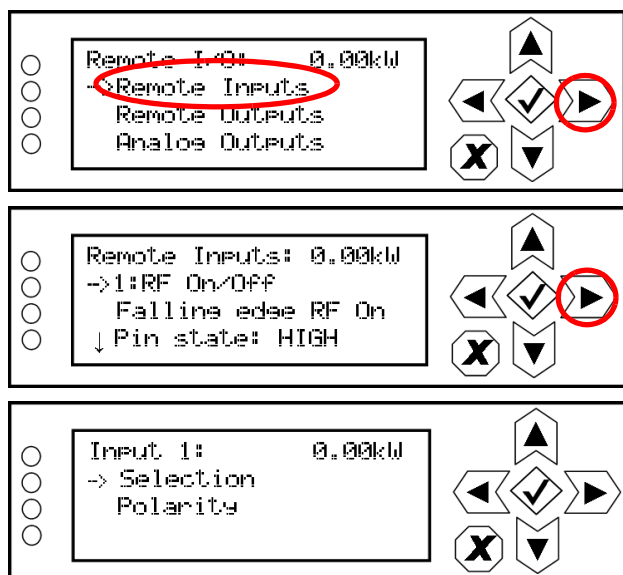


Use the up and down buttons to select Remote Inputs (see [Remote Inputs - Front Panel on page 2-172](#)), Remote Outputs (see [Remote Outputs - Front Panel on page 2-173](#)) or Analog Outputs (see [Analog Outputs - Front Panel on page 2-174](#)) to view or edit detail on the selected inputs or outputs.

### REMOTE INPUTS - FRONT PANEL

Using the Remote Inputs screens (see [Figure 2.146](#)), you can configure up to 10 inputs that allow you to remotely control various operational characteristics of the transmitter. Unless otherwise noted, these inputs are only accepted by the transmitter if remote control is enabled. That setting can only be made by a local user using the front panel UI.

Nautel sets remote input defaults before shipping. See the VS2.5 Pre-installation Manual for details.

**Figure 2.146: Remote Inputs Screens (Input 1 shown)**

Use the up and down buttons to select the desired remote input (1 through 10) from the list. Each screen shows the current remote input parameter (e.g., RF On/Off), as well as the polarity (e.g., Falling edge RF On) and current state (e.g., high, low) of the corresponding input pin. Use the right-arrow button to enter the Selection/Polarity screen for the selected input to allow editing of the selection or the polarity. Press cancel (X) to return to the previous menu.

If you save a change to a remote input via the front panel UI, it will also be displayed on the AUI page.

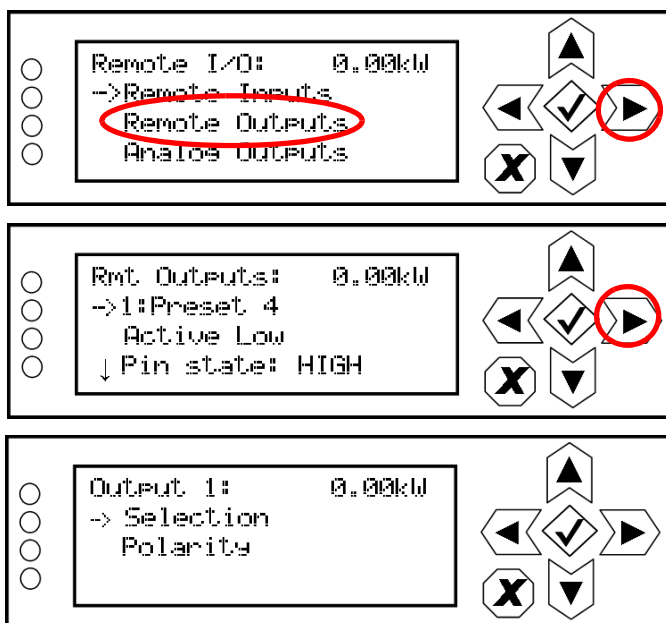
**Note:**  
*The selection and polarity options for remote inputs are the same as described in [Select Input Channel - AUI on page 2-163](#) and [Configure Input control logic - AUI on page 2-164](#).*

### REMOTE OUTPUTS - FRONT PANEL

Using the Remote Outputs screens (see [Figure 2.147](#)), you can configure up to 16 remote outputs that indicate either the presence of various alarms or the status of operator controlled circuits.

Nautel sets remote output defaults prior to shipping. See the VS2.5 Pre-installation Manual for details.



**Figure 2.147: Remote Outputs Screens (Output 1 shown)**

Use the up and down buttons to select the desired remote output (1 through 16) from the list. Each screen shows the current digital output parameter (e.g., RF On/Off), as well as the polarity (e.g., RF On = Low) and current state (e.g., high, low) of the corresponding output pin. Use the right-arrow button to enter the Selection/Polarity screen for the selected output to allow editing of the selection or the polarity. Press cancel (X) to return to the previous menu.

If you save a change to a remote output via the front panel UI, it will also be displayed on the AUI page.

**Note:**

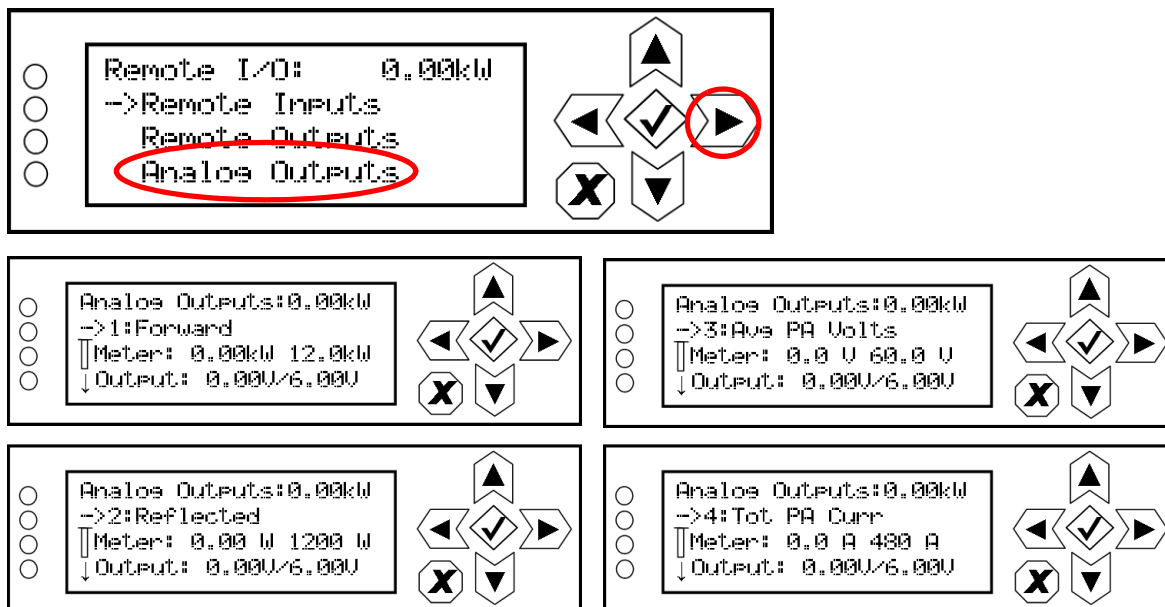
The selection and polarity options for digital outputs are the same as described in [Select output channel - AUI on page 2-166](#) and [Configure output control logic - AUI on page 2-166](#).

**ANALOG OUTPUTS - FRONT PANEL**

Using the Analog Outputs screens (see [Figure 2.148](#)), you can view the levels of four pre-defined analog outputs that are representative of critical transmitter parameters.

Nautel sets analog output defaults prior to shipping. There are no configuration options. They are for monitoring purposes only. See the VS2.5 Pre-installation Manual for details.

Figure 2.148: Analog Outputs Screens



Use the up and down buttons to select the desired analog output (1 through 4) from the list. Each screen shows the analog output parameter (e.g., Forward Power, Reflected Power, Avg PA Volts or Total PA Current), as well as the meter reading (actual and full-scale) and the output pin voltage (actual and full-scale). Press cancel (X) to return to the previous menu.

**Note:**  
*The analog output's Output voltage reading reflects the value that can be measured at the associated remote analog output pin for the given Meter value. See the Pre-installation Manual for actual remote analog output pin assignments.*

## SCHEDULER

If the scheduler is enabled (see [Enabling the Scheduler on page 2-177](#)), you can program a preset schedule for the transmitter. Use the Scheduler page (see [Figure 2.149](#)) to set the dates and times at which presets take effect. You can define up to 63 different schedule rules. To view the Scheduler page, select Scheduler from the Menu options.

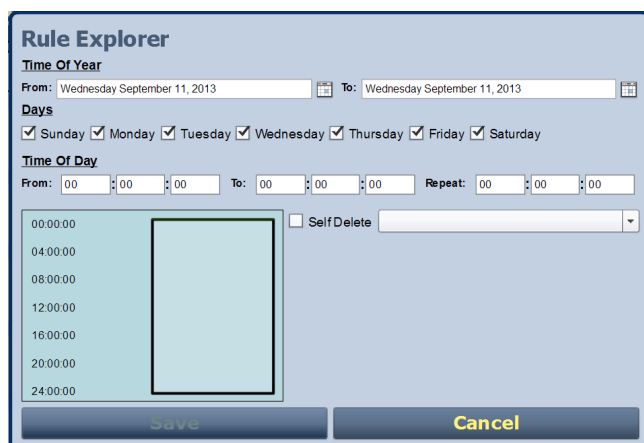
**Figure 2.149: Scheduler page**



The left-hand side of the Scheduler page displays a monthly calendar (e.g., September 2013). Use the << and >> buttons to navigate between months. Use the < and > buttons to navigate to the beginning and the end of the schedule.

The right-hand side of the Scheduler page contains a Rules section and a Daily Events section. All programmed rules are displayed in the Rules section. Clicking on a specific date in the monthly calendar displays the rules and daily events, as applicable, for that day.

**Figure 2.150: Rule Explorer window**



When you click in the Rules list, you have the option to edit or delete an existing rule, or to create a new rule. Click the **New** or **Edit** button to display the Rule Explorer window (see [Figure 2.150 on page 2-176](#)). Click **Delete** to remove a rule from the list.

Use the Rule Explorer window as follows:

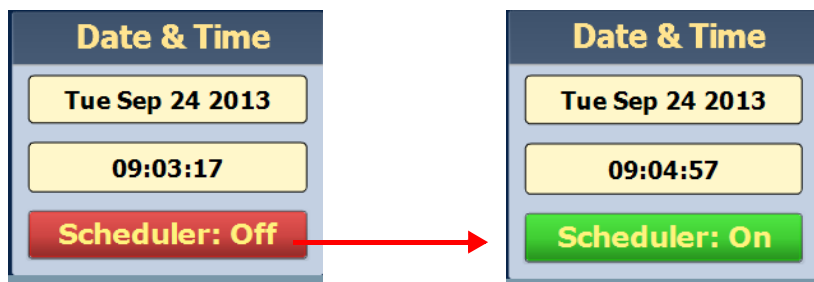
- In the **Time of Year** section, set the start (**From:**) and end (**To:**) dates for the rule. Start to end dates must be less than one year apart.
- In the **Days** section, select the days of the week on which the rule will apply.
- In the **Time of Day** section, set the start (**From:**) and end (**To:**) times (hours, minutes and seconds) for the rule. Use the **Repeat:** field to establish a repeating cycle for the rule (e.g., every 24 hours).
- Use the drop-down menu to select the preset (e.g., **Current Settings**) for the rule. The preset's power, mode and frequency are displayed below the preset.
- Unless you edit other rules first, you cannot select a date that occurs before the start of the previous rule or after the start of the following rule.
- Click the **Save** button to store the rule in the scheduler or the **Cancel** button to return to the Scheduler page.

## ENABLING THE SCHEDULER

You can enable or disable the scheduler using the remote AUI (see [Enabling the Scheduler - AUI](#)) or the local front panel UI (see [Remote I/O Settings - Using the Front Panel UI on page 2-172](#)).

### ENABLING THE SCHEDULER - AUI

Enable or disable the scheduler by clicking the **Scheduler** button in the **Date & Time** section (see [Figure 2.151](#)).

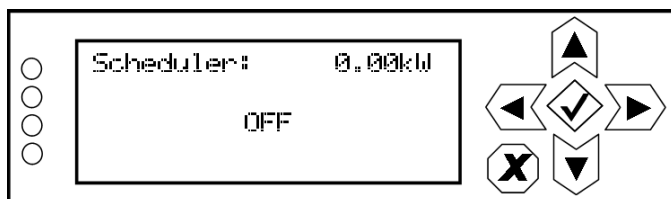
**Figure 2.151: Enabling/disabling the scheduler - AUI**

When Scheduler: ON appears, the transmitter will follow the Scheduler settings.

When Scheduler: OFF appears, the transmitter will stop following the schedule and the active preset will be the preset that was operating when the scheduler was disabled.

#### ENABLING THE SCHEDULER - FRONT PANEL

To view the Scheduler enable/disable screen (see [Figure 2.152](#)) on the front panel display, select User Settings -> Scheduler from the Main Menu.

**Figure 2.152: Enabling/disabling the scheduler - Front Panel**

Use the up and down buttons to select ON (enable) or OFF (disable). The default setting is OFF. Press cancel (X) to return to the previous menu.

## AUDIO PLAYER

The built-in audio player (see [Figure 2.153](#)) can use a file playlist, Livewire or Shoutcast as an audio source. These sources must be configured before they can be used. This section describes how to configure audio player sources. To view the Audio Player page, select **Audio Player** from the Menu options. The Audio Player page has two selectable tabs:

- [Playlist](#) - see page 2-180
- [Streams](#) on page 2-182

**Figure 2.153: Audio Player - Playlist Tab Shown**



The playlist (or Shoutcast/Livewire stream) is typically used as an audio loss backup. For example, the user may operate with Preset 1 using one of the standard audio sources. Preset 1 can be configured to switch to another preset (e.g., Preset 2), which uses a playlist or stream, if Preset 1 loses its audio. See [“Configuring an audio loss backup preset” on page 4-5](#) for more information.

Playlist or stream presets can also be activated by the Scheduler (see [Enabling the Scheduler on page 2-177](#)).

## PLAYLIST

The Playlist tab (see [Figure 2.154](#)) displays the audio files and sequence that currently make up the playlist. Only audio files that are supported (e.g., .wav or .mp3 files) will be played. For .mp3 files, using files with bit rates equal to or less than 96 kbps achieves best audio results. Also, you must activate a preset that has **Audio Player -> AES 2** selected in the **Main Audio -> Audio Source** or **Audio Backup** section of the Presets menu. There are three sections in the Playlist tab - Playlists, Playlist Contents and Available Files on USB.

**Figure 2.154: Managing Playlist Files**



**Note:**

*You should not change an active (playing) playlist nor should you attempt to delete or move a song that is currently playing. To make changes to the playlist, the audio player must be off (inactive) - or at least not being used as the active preset's source.*

The Playlists section is used for adding (Add button) and deleting (Delete button) playlists.

The Playlist Contents section is used for inserting jumps (Insert JMP button) and deleting playlist contents (Delete button). The Insert JMP button allows the user to set up a playlist that can jump to an item in another playlist. You can drag files up and down the Playlist Contents list and you can drag files from the Available Files on USB list to the Playlist Contents list.

The Available Files on USB section is used for adding audio files to the playlist (Add Files button) or refreshing the playlist (Refresh button) . Audio files must be stored on an external USB device plugged into the USB-A (A1J8B) or USB-B (A1J8C) connector on the rear of the controller; they are not stored in the transmitter. Only the audio files stored in the root directory of the most recently connected USB device appear on the playlist. The list will be empty if no USB device is connected. The USB drive must be formatted with a FAT32 file system. Click the Refresh button to force an update of the list of files on the mounted USB.



*Note:*

*MPEG Layer-3 audio coding technology licensed from Fraunhofer IIS and Thomson.*

The length of any filename in the Audio Player USB Playlist must not exceed 255 characters and be no larger than 1 GB in size. The playlist should not exceed 700 files (based on an average file character length of 30, including the extension). If the average file character length is more than 30, the playlist file limit will be reduced.

The audio player supports only one USB device at a time. If multiple USB devices are connected, only the most recently connected USB is recognized as the active USB drive. If multiple USB devices are connected and one is removed, both devices are unmounted.

The Manage Files button displays a pop-up window that allows the user to Browse for files and Upload them to the USB or Delete them from the USB. You should not delete files that are part of more than one playlist.

**Figure 2.155: Audio Player Page - Streams Tab**





## STREAMS

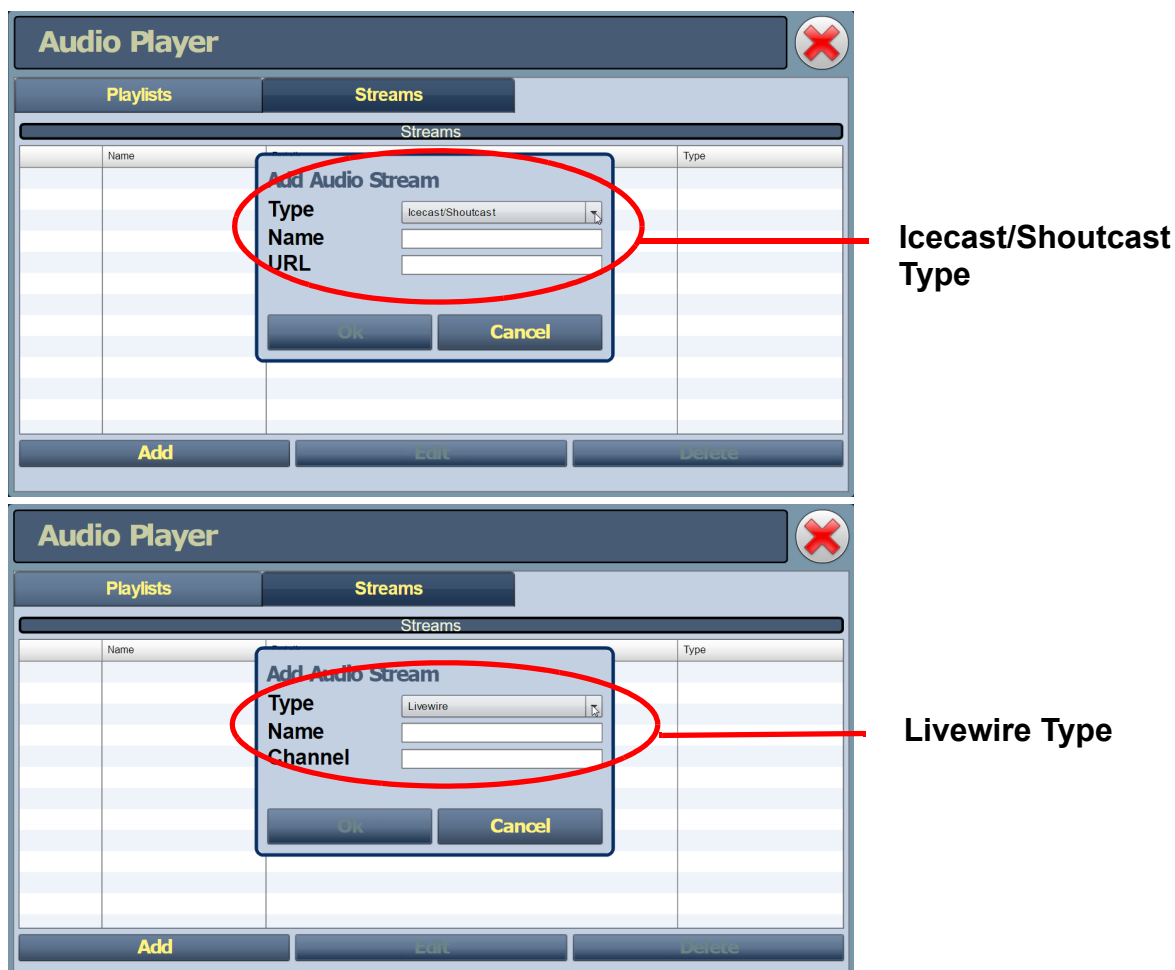
The Streams tab (see [Figure 2.155 on page 2-181](#)) of the VS2.5 is capable of playing audio streams in either Icecast/Shoutcast or Livewire format.

The audio player supports Icecast/Shoutcast playlists and IP addresses for audio streams. For an Icecast or Shoutcast playlist enter the URL for the station. For an audio stream, enter the URL for that stream.

**Note:**  
*If your Icecast/Shoutcast stream drops out, the transmitter will continuously attempt to reconnect to the server, several times per second.*

For Livewire, enter the channel that contains the desired audio.

**Figure 2.156: Adding Audio Streams**



---

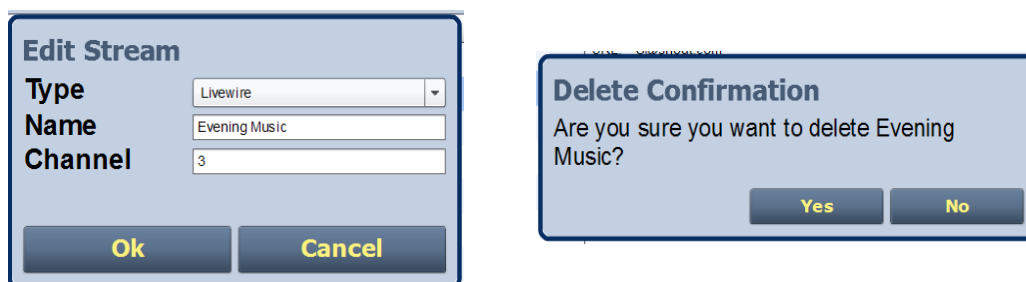
### ADDING AN AUDIO STREAM

1. From the Streams tab (see [Figure 2.156 on page 2-182](#)), click the Add button.
2. Use the drop-down menu to select the desired Type of audio stream - Shoutcast or Livewire.
3. Enter the appropriate information for the audio server (Name and URL for Shoutcast; Name and Channel for Livewire). Make sure the VS2.5 can access the location.
4. Click OK to add the audio stream or click Cancel to discard changes.

### EDITING OR DELETING AN AUDIO STREAM

1. From the Streams tab (see [Figure 2.157](#)), select the desired audio stream from the list. Click the Edit button to modify the audio stream or the Delete button to remove the audio stream.
2. If you are editing an audio stream, enter the appropriate information for the audio server (Name and URL for Shoutcast; Name and Channel for Livewire). Make sure the VS2.5 can access the location.
3. Click OK to either edit or delete the audio stream, or click Cancel to discard changes.

**Figure 2.157: Editing or Deleting an Audio Stream**



---

## ENABLING AND OPERATING THE ORBAN AUDIO PROCESSOR

This section describes how to configure, enable and operate the optional Orban audio processor after it is installed in your transmitter. You can interface with audio processor functionality locally, using the front panel UI or the remote AUI. The extent of the features available depends on which interface is used.

- [Configuring the Transmitter for the Orban Audio Processor - see page 2-185](#)
- [Enabling the Orban Audio Processor for Preset Selection - see page 2-186](#)
- [Selecting an Orban Audio Processor Preset - see page 2-188](#)
- [Managing an Orban Audio Processor Preset - see page 2-190](#)

**Note:**

*Using the Orban Inside option requires the installation of an Orban audio processor card in your transmitter. If you had a pre-existing transmitter when you received your Orban Inside kit, verify that the Orban card has been installed in the transmitter according to the NVLT - Orban Inside Quick Guide (QG12001), provided with the Orban Inside kit. Refer to the Pre-installation and Installation Manuals for information on purchasing and installing this option.*

**Note:**

*This section contains frequent reference to Orban's Optimod-FM 5500 Digital Audio Processor Operating Manual (see the link below). The equipment covered in the 5500 manual uses the same Orban audio processor as in your transmitter. The 5500 manual provides detailed information on the audio processor's functionality. If a discrepancy exists between the operational instructions in the Orban manual and this document, the latter shall prevail as this document is specific to operation with an VS2.5 transmitter. View the Orban Optimod-FM 5500 Digital Audio Processor Operating Manual online at:*

*<ftp://ftp.orban.com/5500/Documentation/>*

*(the version number referenced in this link is controlled by a third party and is subject to change without notice)*

---

## CONFIGURING THE TRANSMITTER FOR THE ORBAN AUDIO PROCESSOR



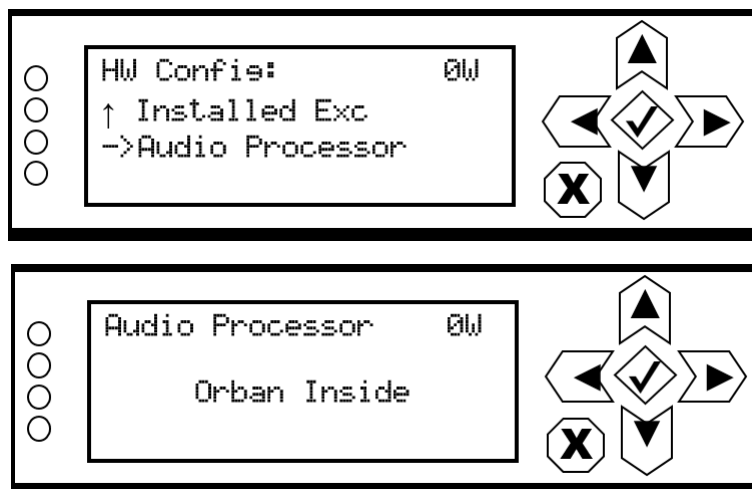
*Note:*

*Audio processor configuration is only available using the front panel UI.*

Configure the VS2.5 to recognize the presence of the Orban card using the front panel UI as follows:

1. With the transmitter turned on and in local mode of operation, navigate to the front panel UI's Main Menu -> System Settings -> HW Config menu. Scroll down through this menu and select Audio Processor (see [Figure 2.158](#)).
2. In the Audio Processor screen (see [Figure 2.158](#)), use the up and down buttons to toggle between None and Orban Inside (default factory setting is None). Select Orban Inside to enable the Orban audio processor for use (selecting None disables it). Press the accept (checkmark) button to save the change. Press cancel (X) to discard changes and return to the previous menu.
3. Reboot the transmitter by switching the ac power off and then on. This will ensure the transmitter properly detects the Orban Inside card upon recovery.

**Figure 2.158: Configuring the Transmitter - HW Config / Audio Processor Screens**



---

## ENABLING THE ORBAN AUDIO PROCESSOR FOR PRESET SELECTION

Enable the Orban audio processor to allow preset selection using either the front panel UI (see [Orban Enabling - Using the Front Panel](#)) or the remote AUI (see [Orban Enabling - Using the Remote AUI - see page 2-187](#)) as follows:



**Note:**

*Enabling the Orban audio processor locally will cause the remote AUI to display an enabled setting. The same occurs on the front panel UI when enabling remotely.*

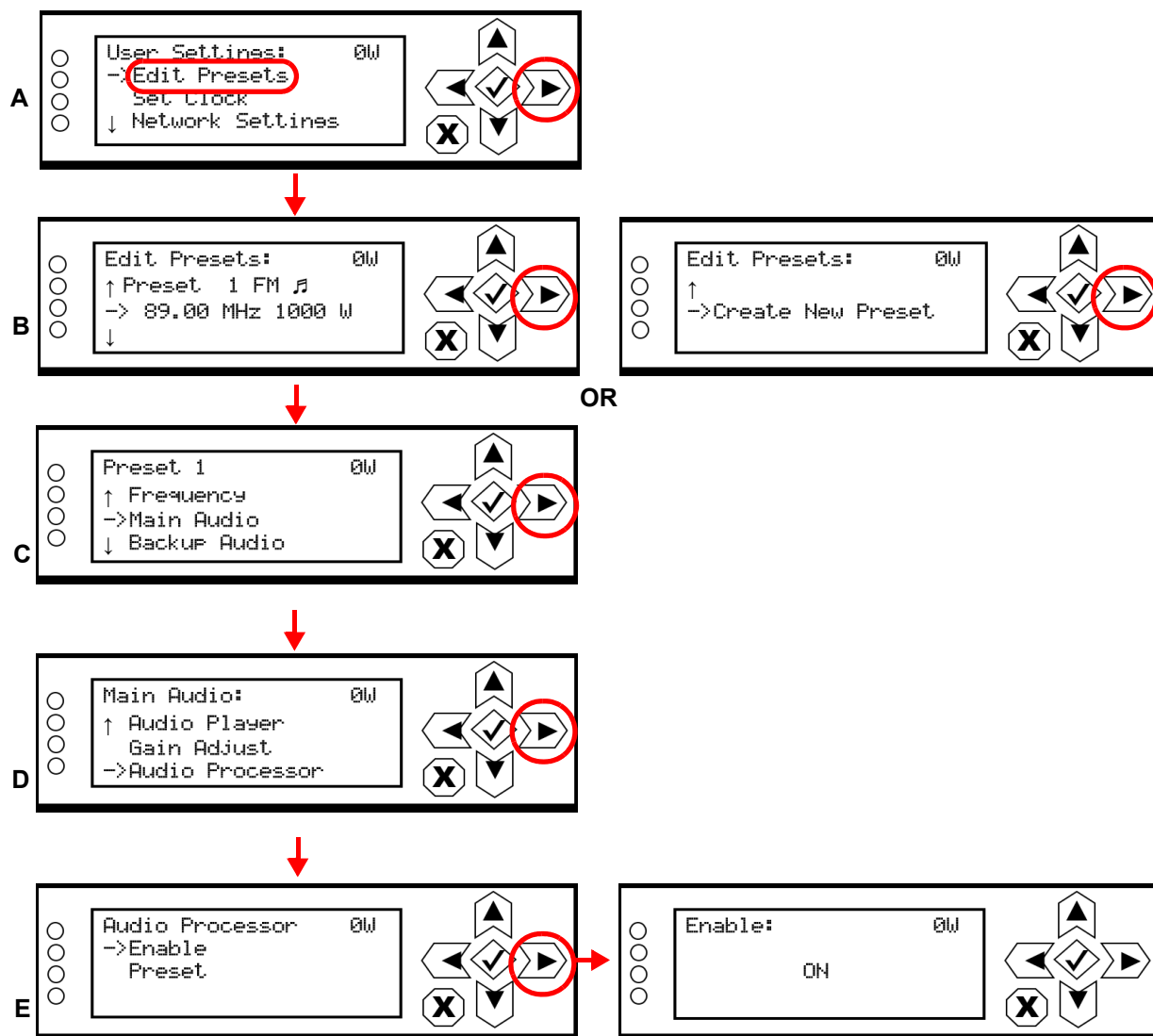
### ORBAN ENABLING - USING THE FRONT PANEL

1. With the transmitter turned on and in local mode of operation, navigate to the front panel UI's Main Menu -> User Settings menu. Select Edit Presets (see A in [Figure 2.159 on page 2-187](#)).
2. In the Edit Presets screen (see B in [Figure 2.159 on page 2-187](#)), select from the list the desired preset for use with the Orban audio processor or create a new preset.
3. Within the selected preset's screen (see C in [Figure 2.159 on page 2-187](#)), scroll down and select Main Audio.
4. Within the Main Audio screen (see D in [Figure 2.159 on page 2-187](#)), scroll down and select Audio Processor. This option appears only when the transmitter has been configured for Orban Inside.
5. Within the Audio Processor screen (see E in [Figure 2.159 on page 2-187](#)), select Enable. From the Enable screen, select ON to enable the audio processor (selecting OFF disables the audio processor).



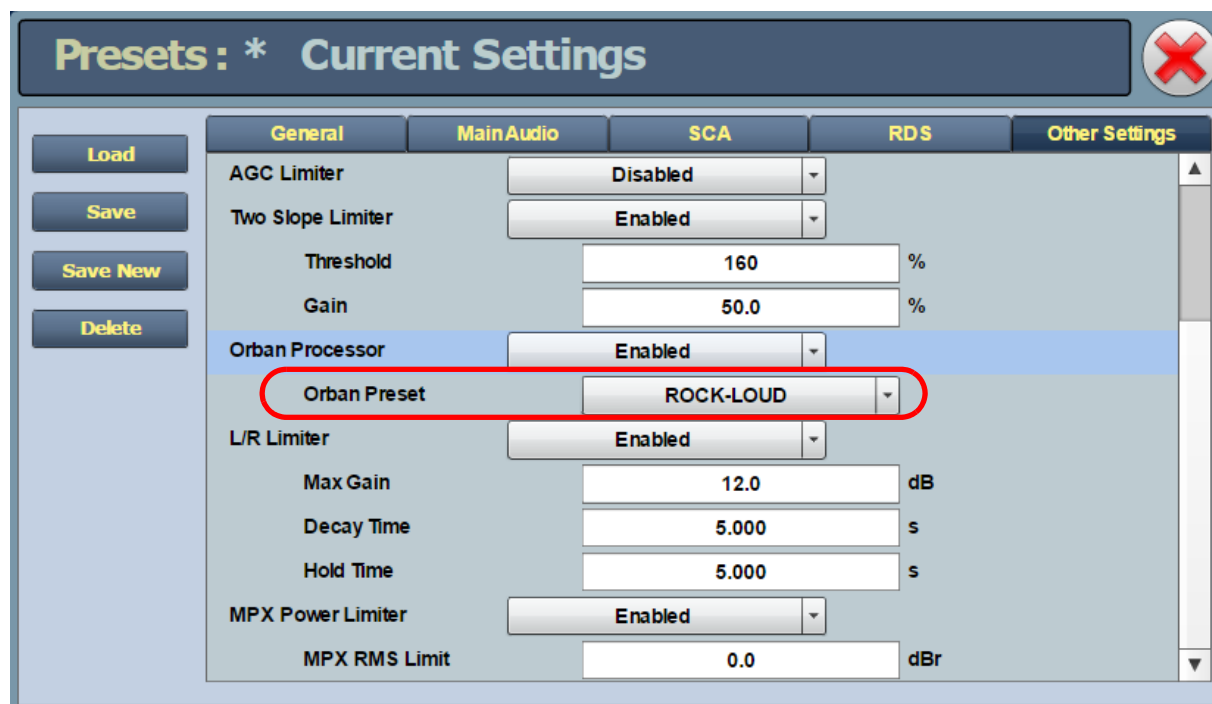
**Note:**

*The Orban Inside card processes only the main audio; however it is possible for the composite SCA inputs to result in excessive modulation. The L/R limiter is automatically disabled when the Orban Inside card is selected; however the other limiters (hard limiter, AGC limiter, 2-slope limiter) remain active. Nautel recommends that you set the thresholds for these other limiters high enough to ensure the signal is unaffected. These other limiters remain as a last resort to prevent over-modulation.*

**Figure 2.159: Enabling the Orban Audio Processor - Front Panel UI****ORBAN ENABLING - USING THE REMOTE AUI**

1. With the transmitter turned on, connected to a remote monitoring PC or laptop and in remote mode of operation, navigate to the AUI's Main Menu -> Presets page.
2. For the applicable preset, click the Other Settings tab (see [Figure 2.160 on page 2-188](#)).
3. In the Orban Processor drop-down list, select Enabled to enable the audio processor (selecting Disabled disables the audio processor). Click Save to store the change.

Figure 2.160: Enabling the Orban Audio Processor - Remote AUI



## SELECTING AN ORBAN AUDIO PROCESSOR PRESET

Select an Orban audio processor preset using either the front panel UI (see [Selecting an Orban Preset - Using the Front Panel](#)) or the remote AUI (see [Selecting an Orban Preset - Using the Remote AUI on page 2-189](#)) as follows:



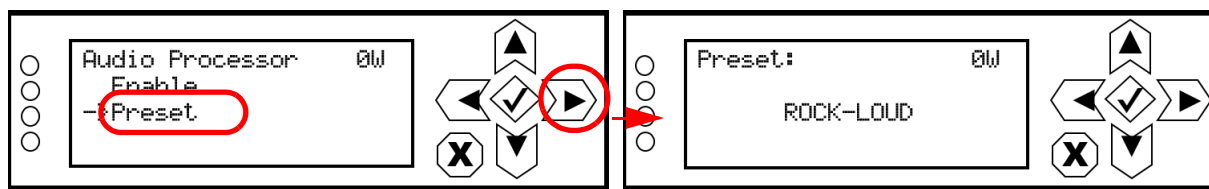
### Note:

*Selecting an Orban preset locally will cause the remote AUI to also reflect the change. The same occurs on the front panel UI when remotely selecting a preset. To create a new Orban Audio Processor Preset, see [Managing an Orban Audio Processor Preset on page 2-190](#)*

## SELECTING AN ORBAN PRESET - USING THE FRONT PANEL

1. From the User Settings -> Edit Presets -> (Select desired preset to edit) -> Main Audio -> Audio Processor menu (see [Figure 2.161](#)), select Preset.
2. Use the up and down arrows to scroll through the list of available Orban presets (e.g., ROCK-LOUD, etc). Select the desired preset and press the 'accept' (checkmark) button to activate. Refer to the Orban Optimod 5500 manual for detailed information on the factory programmed presets available.

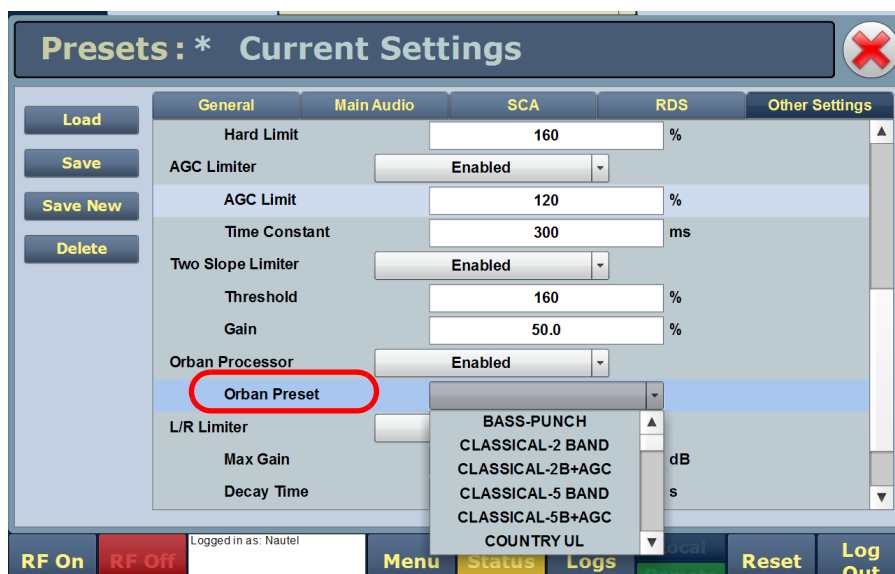
Figure 2.161: Selecting an Orban Preset - Front Panel UI



## SELECTING AN ORBAN PRESET - USING THE REMOTE AUI

1. From the AUI's Main Menu -> Presets page, click on the Other Settings tab (see [Figure 2.162](#)).
2. From the Orban Preset drop-down list, select the desired Orban preset (e.g., ROCK-LOUD, etc). Refer to the Orban Optimod 5500 manual for detailed information on the factory programmed presets available. Click Save to store the change. To create a new Orban preset, see [Managing an Orban Audio Processor Preset on page 2-190](#).

Figure 2.162: Selecting an Orban Preset - Remote AUI





---

## MANAGING AN ORBAN AUDIO PROCESSOR PRESET

Orban presets contain many audio processing settings, including stereo enhancement, AGC, EQ, final clipping and distortion. From the remote AUI (not available from the front panel UI), you can create Orban presets, manage their various settings and save the preset settings to a text file.

When the Orban Inside feature is enabled (see [Enabling the Orban Audio Processor for Preset Selection - see page 2-186](#)), an Audio Processor icon appears on the AUI's Main Menu window (see [Figure 2.163](#)). Click this icon to enter the Audio Processor menu (see [Figure 2.164 on page 2-191](#)).

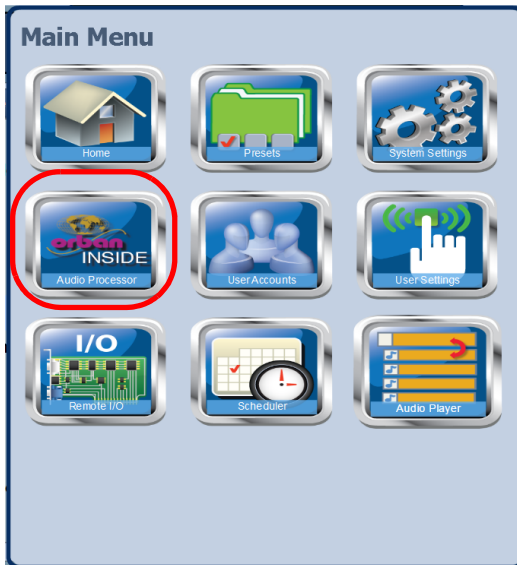
**WARNING:**

*When you open the Audio Processor page while the transmitter is on and Orban is enabled, the active preset in the Orban audio processor is loaded by default. Loading another Orban preset causes that preset to become active. Make sure you understand the impact that a preset change will have on your broadcast.*

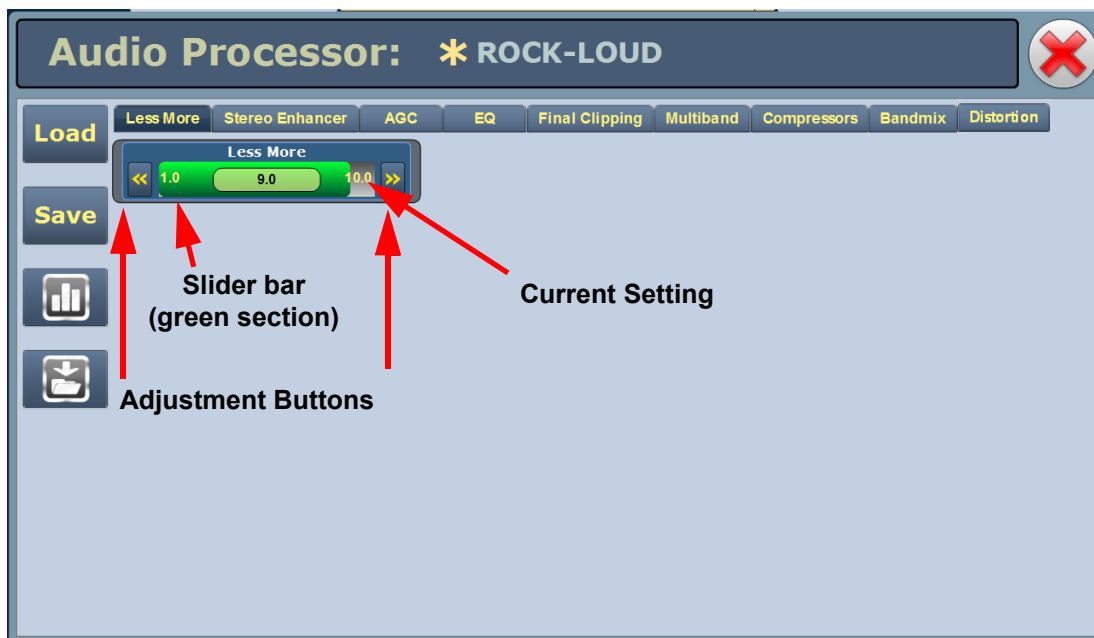
**Note:**

*The Audio Processor page contains nine tabbed sections that allow managing of Orban presets. These tabbed pages (see [Figure 2.164 on page 2-191](#) through [Figure 2.172 on page 2-197](#)) illustrate the many parameters associated with an Orban preset. Detailed descriptions are not included in this document. Refer to the Orban Optimod 5500 manual for more information on setting these parameters.*

**Figure 2.163: AUI Main Menu - with Audio Processor icon**



**Figure 2.164: Audio Processor Menu - Less More Tab Shown**



**LOADING AND SAVING ORBAN PRESETS**

The left-hand side of the Audio Processor pages has four buttons (see below).

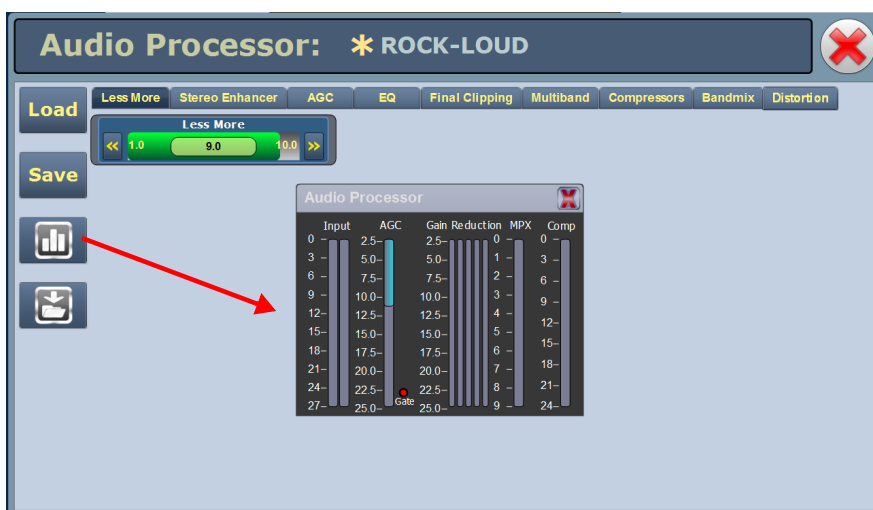
When you first enter the Audio Processor page, the current preset is displayed. If the current preset is not the preset you want to work with, click the Load button to call up a window containing a list of alternate presets. Presets that display an 'F' are factory presets that cannot be modified. Presets that display a 'U' are user presets that can be modified.

To activate any change in the Audio Processor page, click the Save button and then click the Save Preset window's Save As button [Save As and Delete buttons not available for factory (F) presets]. When creating a new preset, you can also enter a new name in the Save Preset window before clicking the Save As button. Click Cancel to discard changes and return to the Audio Processor page.

Clicking this button opens an Audio Processor meter window (see [Figure 2.165 on page 2-192](#)) that displays various meters that indicate levels for inputs, AGC, gain reduction, multiplex (MPX) power and composite. Refer to the Operation section of the Orban Optimod 5500 manual for detailed information on these meters.

Clicking this button opens a window that allows downloading a text version of the preset to a folder on your PC or laptop.

**Figure 2.165: Audio Processor meter window**



There are two types of Orban audio processor presets: factory presets and user presets. Factory presets, designated by an 'F' in the **Load** or **Save** screens, cannot be modified. When a factory preset control is changed, a new preset is automatically created. This preset's default name will be the same as the Orban preset with an asterisk (\*) prefix (e.g., \* EXTREME). Modified presets should be saved to a new name, otherwise they will be overwritten by any edits made to subsequent presets. A saved preset will display as a User preset, designated by a 'U' in the **Load** or **Save** screens. User presets can be modified.

**Note:**

*When editing saved User presets, the best practice is to load a preset that is close to the desired configuration and then adjust its settings for the exact configuration.*

**TAB SECTIONS**

The following tabs (and referenced Figure numbers) are available on the **Audio Processor** page. Each provides specific control functions for the selected preset. Refer to the Orban Optimod 5500 manual for details on these settings.

- Less More - see [Figure 2.164 on page 2-191](#)
- Stereo Enhancer - see [Figure 2.166 on page 2-194](#)
- AGC - see [Figure 2.167 on page 2-194](#)
- EQ - see [Figure 2.168 on page 2-195](#)
- Final Clipping - see [Figure 2.169 on page 2-195](#)
- Multiband - see [Figure 2.170 on page 2-196](#)
- Compressors - see [Figure 2.171 on page 2-196](#)
- Bandmix - see [Figure 2.172 on page 2-197](#)
- Distortion - see [Figure 2.173 on page 2-197](#)

See [Figure 2.164 on page 2-191](#). Each control shows the current setting (in the middle of the control) and the available range of settings. You can make adjustments either by clicking on the << or >> buttons or by moving (click, hold and move mouse accordingly) the green slider bar, which indicates the setting graphically.

Figure 2.166: Audio Processor Menu - Stereo Enhancer tab



Figure 2.167: Audio Processor Menu - AGC tab



**NOTE:** The AGC Ratio range displays as Inf:1 to 2:1. Although you cannot set the AGC Ratio to Inf:1 (it will default to 4:1), some Orban presets are defaulted for an Inf:1 setting. Nautek recommends you edit the setting to an appropriate ratio (4:1, 3:1 or 2:1).

Figure 2.168: Audio Processor Menu - EQ tab



Figure 2.169: Audio Processor Menu - Final Clipping tab



Figure 2.170: Audio Processor Menu - Multiband tab



Figure 2.171: Audio Processor Menu - Compressors Tab



Figure 2.172: Audio Processor Menu - Bandmix Tab



Figure 2.173: Audio Processor Menu - Distortion Tab



**NOTE:** The number of adjustable controls may vary with the type of Orban Preset (e.g., ROCK-LOUD, COUNTRY UL, etc.)





---

## SECTION 3: ROUTINE MAINTENANCE

This section provides instructions for performing routine maintenance on the VS2.5 transmitter. This section includes the following topics:

- [Scheduled maintenance](#)
  - [Cleaning fan filters - see page 3-1](#)
  - [Checking hardware - see page 3-2](#)
  - [Battery replacement - see page 3-2](#)
- [Performing on-air checks - see page 3-4](#)
- [Replacing the Exciter/Control PWB battery - see page 3-5](#)

---

### SCHEDULED MAINTENANCE

Scheduled maintenance consists of performing a visual inspection of the VS2.5 at scheduled intervals. The recommended minimum time between scheduled maintenance visits is 12 months. Local operating and environmental conditions may dictate more frequent visits, while in remote sites, less frequent visits may be acceptable. Experience and system reliability will determine the most practical schedule for a specific installation.

### CLEANING FAN FILTERS

Remove the air filter (see [Figure 3.1 on page 3-3](#)) by removing the front panel grill section that is secured with four M4 hex screws. Use the HY93 hex tool provided in the ancillary kit to loosen the screws just enough to allow removal of the front panel grill. Remove the PVC retaining plate and then the filter media from the grill section, rinse it with water, then re-install the air filter. If an air filter becomes damaged, replace it as soon as possible. See [“Replacing a damaged air filter” on page 3-2](#).



*Note:*

*A site located in a dirty area using open-air cooling requires more extensive cleaning than a site located in a clean area using closed-air cooling.*

## CHECKING HARDWARE

All hardware must be checked at least once a year. Nautel recommends more frequent checking if the VS2.5 is subjected to above average thermal cycling, caused by turning the VS2.5 on and off.

- To prevent damaging the hardware, ensure that the proper size tools are used. In most cases, hardware is metric.
- A mounting surface or terminal that has changed colour indicates a loose hardware connection.

## BATTERY REPLACEMENT

The VS2.5's Exciter/Control PWB contains a battery backup circuit that allows the time and date to update during ac power failure. The battery should be replaced every 12 months. See [“Replacing the Exciter/Control PWB battery” on page 3-5](#).

---

## REPLACING A DAMAGED AIR FILTER

If an air filter becomes damaged, replace it as follows:

### PARTS AND TOOLS

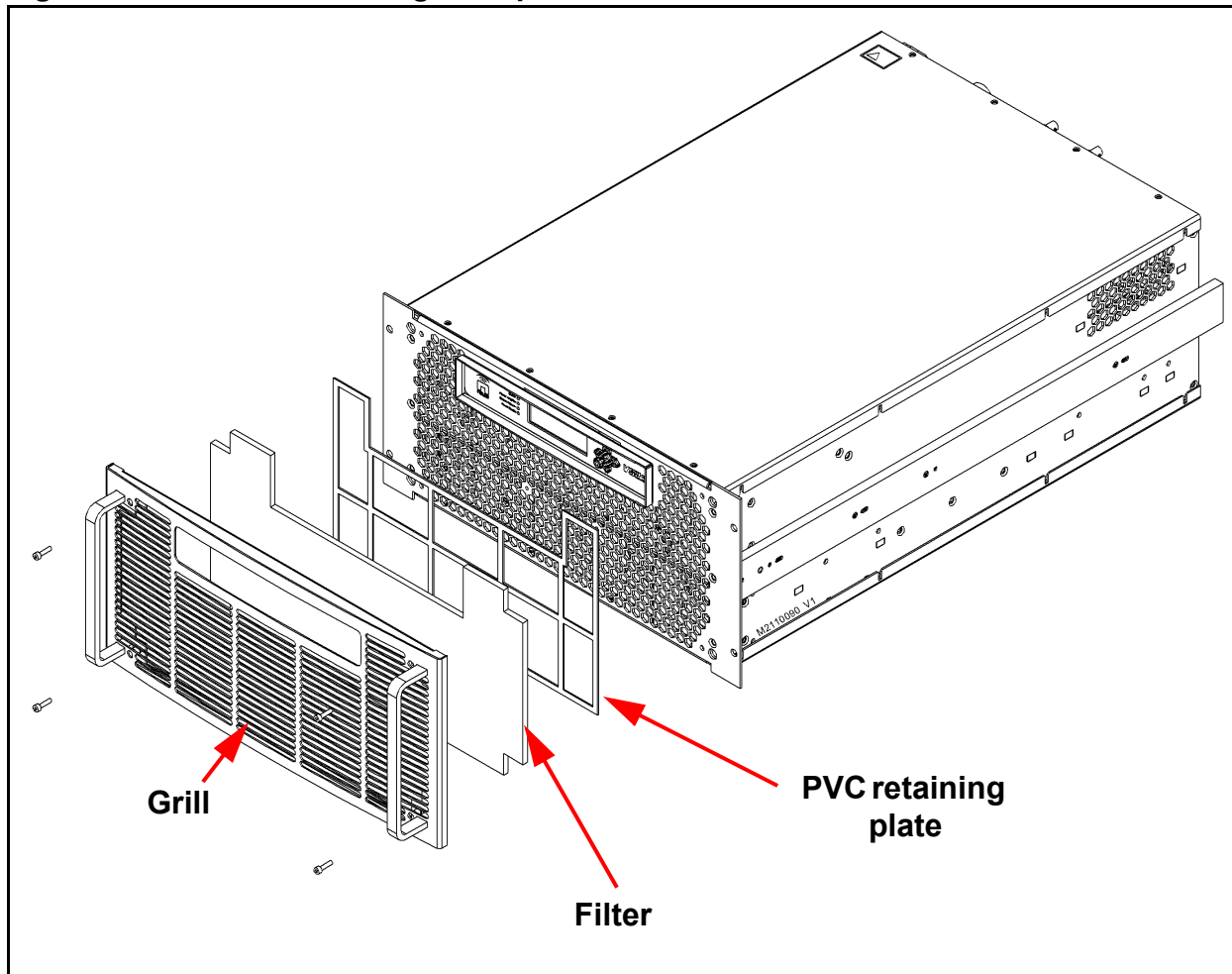
- Replacement air filter
- Hex tool, 3 mm (Nautel Part # HY93, provided in ancillary kit)

### PROCEDURE

Replace the air filter in the front panel of the transmitter (see [Figure 3.1 on page 3-3](#)) as follows:

1. Order a new filter, as necessary, from Nautel (part # HAM78).
  2. Gain access to the old filter by removing the front panel grill section secured with four captive M4 hex screws. Use the HY93 hex tool from the ancillary kit and loosen the screws just enough to allow removal of the front panel grill.
  3. Temporarily remove the PVC retaining plate from the grill section and remove the old filter.
  4. Insert the new air filter, re-insert the PVC retaining plate into the grill section and then re-install the front panel grill.
  5. Dispose of the damaged air filter.
-

**Figure 3.1: Air Filter Cleaning or Replacement**



---

## PERFORMING ON-AIR CHECKS

You should check the on-air quality of the transmitter's signal periodically. This check can be done locally at the transmitter site, or remotely from another location in the transmitter's coverage area.

### INTERVAL


Every 12 months, or as required by law.

### PARTS AND TOOLS

- High-quality receiver, compatible with the modulation scheme used on the transmitter.

### PROCEDURE

1. Monitor the transmitter signal to identify any problems:
  - Use a high quality receiver to monitor audio quality.
  - Take a portable receiver to different locations in your coverage areas to identify any problems with the antenna pattern or areas of localized interference.
2. Obtain the *Proof of Performance* document that was completed during factory testing and provided with the transmitter. Use the front panel UI or the remote AUI to compare current transmitter meter readings with those in the *Proof of Performance* document.

 **Note:** *Nautel completes the Proof of Performance document with the transmitter operating at 98 MHz, terminated into a precision 50 ohm load. Measurements made at other operating frequencies may not yield the same readings. Your front panel meter readings may not be exactly the same as shown, but if an out-of-tolerance condition exists, an alarm will be displayed.*

---

## REPLACING THE EXCITER/CONTROL PWB BATTERY

Replace the battery on the Exciter/Control PWB (A1) once a year, or whenever the Controller - Low Battery alarm appears (on the front panel UI or via remote AUI). Chemical leakage from an old battery can cause damage. Also, the Exciter/Control PWB's microcontroller may not retain its settings if ac power is turned off while the backup battery power is low. The battery should be replaced while ac power is applied to the transmitter.

**Note:**

*The Exciter/Control PWB's battery is used only for the RTC clock (clock, logs, and RDS clock information, if used). If the battery fails and an ac power loss occurs, the state prior to the ac loss is retained; the transmitter recovers to the same preset, local/remote mode, and RF on/off mode (these settings are stored in EEPROM). Reset the clock(s) and note that any logged events that occurred before replacing the battery will be reflected by the time error.*

### INTERVAL

Every 12 months.

### PARTS AND TOOLS

Replacement battery: 3 V lithium coin cell, 20 mm (Panasonic # CR2032 or equivalent).

### PROCEDURE

Perform the following steps to replace the battery:

1. Ensure ac power is being applied to the transmitter.
2. Gain access to the Exciter/Control PWB (A1) by removing the transmitter's top cover.
3. Replace battery BT1 on the Exciter/Control PWB. See Figures MD-1 and MD-2 in the mechanical drawings section at the end of the *VS2.5 Troubleshooting Manual* to locate the Exciter/Control PWB (A1) and its battery (BT1).
4. Re-install the transmitter's top cover.
5. Check for any alarms on the front panel UI or remote AUI. Battery related alarms should clear. (See [“Alarms” on page 2-18.](#))



---

## SECTION 4: NON-STANDARD MAINTENANCE

This section provides instructions for performing non-standard maintenance on the VS2.5 transmitter. This section includes the following topics:

- [Upgrading software](#)
- [Configuring an audio loss backup preset - see page 4-5](#)

---

### UPGRADING SOFTWARE

Periodically, enhancements or improvements to the operating system are identified and made available. Perform a software upgrade, as required, as follows:



*Note:*

*Nautel recommends you perform a software upgrade at the transmitter site.*

*For port-forwarded transmitters, uploading of the .tgz file must occur locally or on the transmitter side of the router.*

### PARTS AND TOOLS

- Laptop (i.e., local computer for direct connection) or network computer with Windows and Internet Explorer Web browser
- CAT5 Ethernet cable
- Upgrade software (\*.tgz file), provided via email or web download

### PRELIMINARY CHECKS

1. Determine the current software revision installed. Via the advanced user interface (AUI) screen, go to **Menu/System Settings/Upgrade Software**. Note the software version in the Current Version field (i.e., 4.0.0.99).
2. Contact Nautel for the most recent software revision and download \*.tgz file to a laptop or network location.



---

## TRANSFERRING UPGRADE FILE

The following steps assume either the laptop will be used to connect directly to the transmitter **OR** the transmitter and network computer are currently connected to the same network.

### TRANSMITTER IP CONFIGURATION

1. From the transmitter AUI, go to Menu/User Settings/Network Settings.
2. Record your current network settings (IP Address, Subnet Mask, Default Gateway, etc.).
3. If connecting to the transmitter directly with a laptop, you must set a static IP address. This can only be done via the front panel interface. From the front panel UI's Main Menu, go to User Settings/Network Settings and set the IP address as follows:
  - DHCP: OFF
  - IP Address: 10.10.10.2
  - Subnet mask: 255.255.255.0
4. Set the transmitter for Remote control.

### LAPTOP IP SETUP

The following steps assume the operating system is Windows XP. Adapt as required for computers with different operating systems.

1. On the laptop go to Start Menu/Control Panel/Network Connections/Local Area Network.
2. In the Local Area Network Status, open the General tab and choose Properties. Scroll down and highlight Internet Protocol (TCP/IP). Choose Properties.
3. In the *Internet Protocol (TCP/IP) Properties* window, select Use the following IP address.
4. Enter the following settings:
  - IP Address: 10.10.10.1
  - Subnet Mask: 255.255.255.0
  - Default Gateway: 10.10.10.3
5. In the *Internet Protocol (TCP/IP) Properties* window, select OK.
6. In the *Local Area Connection Properties* window, select OK.

7. In the *Local Area Connection Status* window, select Close.
8. Close the *Network Connections* window.

#### TRANSFER SOFTWARE UPGRADE FILE TO TRANSMITTER

1. If using a laptop, connect the laptop network interface card to the transmitter LAN (A1J8A) connector on the rear panel using a CAT5 Ethernet cable. Open Internet Explorer and search for 10.10.10.2. The transmitter login screen should appear.
2. If using a network computer, open Internet Explorer and search for the IP address recorded in [Step 2](#) of “[Transmitter IP configuration](#)” on [page 4-2](#). The transmitter login screen should appear.
3. At the transmitter login screen enter:
  - User: “Nautel” or “\*\*\*\*”, where \*\*\*\* is the user assigned user name
  - Password: leave blank (default) or “\*\*\*\*”, where \*\*\*\* is the user assigned password
4. Navigate through the AUI to Menu/System Settings/Upgrade Software and press Manage Files/Browse. Locate the software update \*.tgz file and press Upload to load the file into the transmitter Software Upgrade File list.



*Note:*

*For port-forwarded transmitters, uploading of the .tgz file must occur locally or on the transmitter side of the router.*

## INSTALLING NEW SOFTWARE

1. Set the transmitter to RF Off and for Remote control. Perform the following steps remotely using the AUI on the laptop.
2. Go to the AUI's Menu/System Settings/Upgrade Software screen and select the update \*.tgz file from the Select Upgrade Files list (should highlight in blue) and press Start Upgrade.
3. After a successful load (status is 100% complete and a message indicates a successful load), cycle the ac power (turn off, then on) on the VS2.5.
4. This completes the software upgrade. Restore the former network settings on the transmitter and laptop as required (see [Step 2](#) of "Transmitter IP configuration" on [page 4-2](#)).
5. Clear the cache of every web browser used to remotely connect to the transmitter's AUI to ensure that the remote AUI displays correctly after the software upgrade.
6. Login and repeat [Step 1](#) of "Preliminary checks" on [page 4-1](#) to determine if the current version is the same as the upgrade version - this confirms the upgrade was successful.
7. If the upgrade was not successful, repeat [Step 1](#) through [Step 6](#). If still unsuccessful, contact Nautel.
8. Go to the AUI's Menu/User Settings/SNMP Configuration screen. Check the Read Community and Write Community passwords. If they have reset (i.e., the field is blank), you must re-enter them (see "SNMP Configuration" on [page 2-76](#)).

## CONFIGURING AN AUDIO LOSS BACKUP PRESET

The VS2.5 contains an audio level detection circuit that can be used, when enabled, to allow switching to a secondary (backup) audio input source upon the loss of the primary source. Configure the desired transmitter preset to perform this function as follows (refer also to Section 2 of this manual for operating instructions of the front panel (UI) and remote (AUI) interfaces:



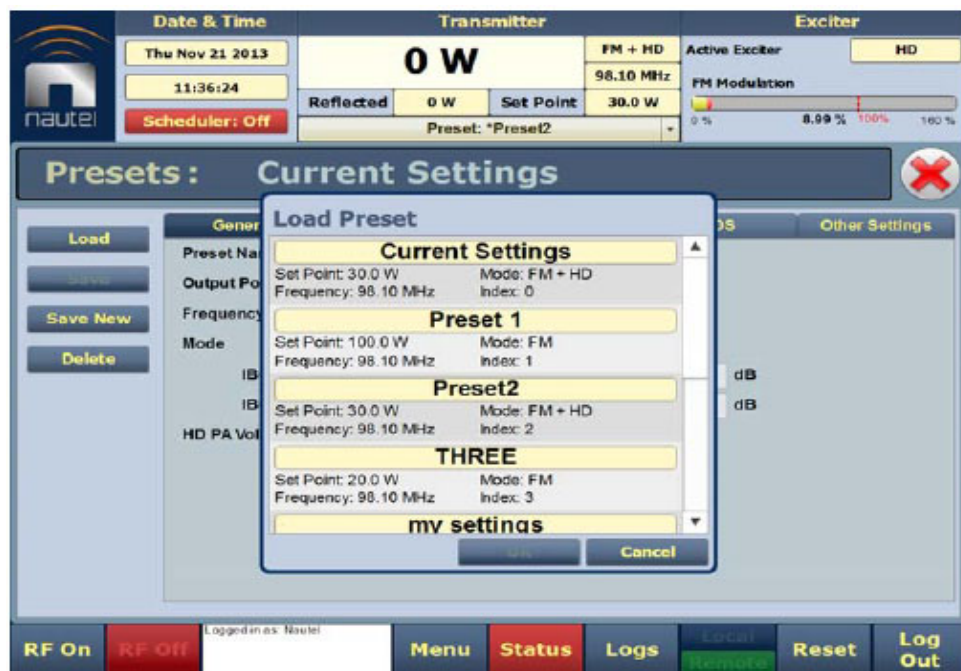
*Note:*

*You must configure a minimum of two presets to allow this feature to operate. One preset will act as the primary, or normal operating preset. The second preset will act as the secondary, or backup audio preset. Configure the backup audio preset first.*

## CONFIGURING THE BACKUP AUDIO PRESET

1. From the transmitter remote AUI, go to Menu/Presets/Load. The Load Preset window in [Figure 4.1](#) shall display.
2. Select a suitable preset to use as a template to create a new backup audio preset. Click OK.

**Figure 4.1: Load the Backup Preset Template**



**Figure 4.2: Backup Preset Main Audio screen**

3. The setup page for the selected preset should now appear. Click the Main Audio tab (see [Figure 4.2](#)).
4. Click the Audio Source field's drop-down arrow to view the available audio sources. Select the desired backup audio source.
5. Configure the other fields associated with your Audio Source selection.
6. To save your changes without affecting the original template preset's settings, create a new preset as follows (see also [Figure 4.3 on page 4-7](#)):
  - Click the Save New button on the left side of the AUI display. The Save New window will appear.
  - A new name field appears. Enter the new name of the backup preset being created (e.g., Back Up Audio Preset).
  - After naming the new backup audio preset, click the OK button.
  - This will save the preset as a new preset and not effect the original template preset. This completes configuration of the Backup Audio preset. Return to the home AUI panel.

Figure 4.3: Saving the Backup Preset



## CONFIGURING THE PRIMARY AUDIO PRESET

1. Go to Menu/Presets/Load. The Load Preset window in [Figure 4.1 on page 4-5](#) shall display.
2. Select your primary or normal preset to allow editing of its audio loss parameters. Click Load.
3. The setup page for the selected preset should appear. Click the Other Settings tab (see [Figure 4.4](#)).
4. Open the Mod Loss Timeout field's drop-down menu. Select Enabled. This will display five sub-fields - Action, Mod Loss Preset, Timeout Minutes, Timeout Seconds and Threshold.
  - Open the Action field's drop-down menu. Select Change Preset.
  - Open the Mod Loss Preset field's drop-down menu. Select the newly created backup audio preset.
  - Enter in the Timeout Minutes and/or Timeout Seconds fields the desired delay between the loss of audio and the action to change to the backup preset.
  - Enter in the Threshold field the desired percentage level of audio at which the timeout period begins. Typically, this is set to 10%.

**Figure 4.4: Normal Preset - Other Settings screen**

The screenshot displays the Nautel radio control interface. At the top, there are sections for 'Date & Time' (Thu Nov 21 2013, 12:21:09), 'Transmitter' (0 W, 98.10 MHz, 30.0 W), and 'Exciter' (Active Exciter: HD, FM Modulation: 8.99%). Below this is a 'Presets' section with a dropdown menu showing '\* Test Preset New'. The main area is divided into tabs: 'General', 'Main Audio', 'SCA', 'RDS', and 'Other Settings'. The 'Other Settings' tab is active, showing various parameters:

Parameter	Value	Unit
Pilot Level	9.0	%
Pilot 1PPS Sync	Off	
Audio Delay	No	
Mod Loss Timeout	Yes	
Action	Change Preset	
Mod Loss Preset	Test Preset New	
Timeout Minutes	0	min
Timeout Seconds	5.0	sec
Threshold	0	%
Hard Limiter	No	
AGC Limiter	Disabled	
Two Slope Limiter	Disabled	

At the bottom, there are buttons for 'RF On', 'RF Off', 'Menu', 'Status', 'Logs', 'Reset', and 'Log Out'. The 'Local' button is highlighted in green.

**Notes:**

*SCA, RDS and Pilot modulation levels are additive and contribute the audio level. If their combined levels exceed the audio loss threshold level, a preset change will not occur.*

*Stations with audio content containing extended nulls or silent periods (e.g., classical music) should consider reducing the audio loss threshold or increasing the timeout period.*

5. After configuring the audio loss parameters, click the **Save** button.
6. This completes configuration of the Primary Audio preset. Return to the home AUI panel.





---

## SECTION 5: LIST OF TERMS

This section defines some of the terms that are used in Nautel documentation.

**AES-EBU.** Audio Engineering Society/European Broadcasting Union (AES/EBU) is the name of a digital audio transfer standard. The AES/EBU digital interface is usually implemented using 3-pin XLR connectors (the same type connector used in professional microphones). One cable carries both left-channel and right-channel audio data to the receiving device.

**ARM.** Advanced RISC (Reduced Instruction Set Computer) Machine. The specific ARM used in VS transmitters is ARM926, and is used for remote AUI functionality.

**AUI.** The Advanced User Interface is the web interface that allows for extensive control and monitoring of the transmitter.

**CUTBACK.** A reduction in RF output power, caused by the occurrence of multiple shutbacks within a pre-defined period.

**CYCLING AC POWER.** Turning off (disabling), then turning on (enabling) the ac power source.

**DHCP.** Dynamic Host Carrier Protocol.

**DSP.** Digital Signal Processing. Used for transmitter control and signal processing.

**EEPROM.** Electrically Erasable Programmable Read-Only Memory.

**FOLDBACK.** A reduction in RF output power, caused by adverse load conditions (high VSWR). No shutbacks or cutbacks have occurred.

**INTERMEDIATE POWER AMPLIFIER (IPA).** Refers to circuitry within the transmitter that amplifies the exciter's RF output to a level sufficient to drive the final RF amplifiers.

**LATCHING ALARM.** An alarm that, while active, keeps the transmitter in an 'RF inhibited' state. This type of alarm (e.g., High SWR Shutdown) require a reset - via the front panel or remote AUI - to attempt to restore transmitter operation.

**LED.** Light Emitting Diode (also referred to as lamp).

**LUT.** Look-Up Table.

**MPX.** Refers to the multiplexed baseband signal. Also referred to as the composite signal.

**PRESET.** A setting that controls power level, frequency and audio parameters. The VS2.5 allows you to pre-program multiple presets.

**PWB.** Printed Wiring Board.

**SHUTBACK.** A complete, but temporary loss of RF output power, caused by any one of a variety of faults, including high VSWR, high reject load power, RF drive failure, or an open external interlock.

**SHUTDOWN.** A complete and permanent loss of RF output power. Typically follows repeated cutback, foldback or shutback events.

**SPI.** Serial Peripheral Interface. A synchronous serial data link standard that operates in full duplex mode. Devices communicate in master/slave mode where the master device initiates the data frame. Multiple slave devices are allowed with individual slave select (chip select) lines. Also referred to as a "four wire" serial bus.

**SURGE PROTECTION PANEL.** An electrical panel that protects equipment from electrical surges in the ac power supply, antenna or site ground caused by lightning strikes.

**VSWR.** Voltage standing wave ratio. This is an expression of the ratio of forward voltage to reverse voltage on the feedline and antenna system. An ideal VSWR of 1:1 provides maximum transmitter-antenna efficiency.



## VS2.5 OPERATIONS AND MAINTENANCE MANUAL

Document: NHB-VS2.5-OPS

Issue: 12.1 2022-07-22

### **Nautel Limited**

10089 Peggy's Cove Road  
Hackett's Cove, NS Canada B3Z 3J4

Toll Free: +1.877.6NAUTEL (662.8835)  
(Canada & USA only) or

Phone: +1.902.823.3900 or

Fax: +1.902.823.3183

### **Nautel Inc.**

201 Target Industrial Circle  
Bangor, Maine USA 04401

Phone: +1.207.947.8200

Fax: +1.207.947.3693

### **Customer Service (24-hour support)**

+1.877.628.8353 (Canada & USA only)

+1.902.823.5100 (International)

Email: [support@nautel.com](mailto:support@nautel.com)

Web: [www.nautel.com](http://www.nautel.com)

© Copyright 2022 NAUTEL. All rights reserved.

