

---

## SECTION 1: RESPONDING TO ALARMS

This section provides instructions you need when performing troubleshooting on the NX100 transmitter. This section includes the following topics:

- [Corrective maintenance](#)
- [Electrostatic protection - see page 1-3](#)
- [Identifying an alarm - see page 1-4](#)
- [Responding to alarms - see page 1-20](#)
- [Troubleshooting RF power modules - see page 1-29](#)
- [Other Module Replacement Procedures - see page 1-19](#)

If none of the procedures and alarms described in this section address your problem, contact Nautel for assistance.

---

### CORRECTIVE MAINTENANCE

Corrective maintenance procedures consist of identifying and correcting defects or deficiencies that arise during transmitter operation. Local and/or remote alarm signals are generated when a malfunction occurs. If an alarm condition is caused by a malfunction in the RF power stage, the transmitter may maintain operation at a reduced RF output level. The nature of the fault – and station policy – will dictate whether an immediate maintenance response is necessary. Fault analysis and rectification may be conducted from three different levels, with a different technical competence level required for each: on-air troubleshooting, remote or local, and off-air troubleshooting.

**CAUTION:**

The transmitter contains many solid state devices that may be damaged if subjected to excessive heat or high voltage transients. Every effort must be taken to ensure that circuits are not overdriven or disconnected from their loads while turned on.

### ON-AIR TROUBLESHOOTING

On-air troubleshooting can be performed from a remote location, or locally at the transmitter site.

## REMOTE TROUBLESHOOTING

Remote on-air troubleshooting consists of monitoring the transmitter's radiated signal using an on-air monitor, and observing the status of each remote fault alarm indicator. Information obtained from these sources should enable an operator to decide whether an alarm response may be deferred to a more convenient time, an immediate corrective action must be taken, or if a standby transmitter must be enabled (if one is available). It is recommended that the significance of remote indications, and the appropriate responses, be incorporated into a station's standard operating procedures. Refer to “Identifying an alarm” on page 1-4 to determine the remedial action required for a given fault.

## LOCAL TROUBLESHOOTING

Local on-air troubleshooting consists of monitoring the transmitter's integral meters and fault alarm indicators. Analysis of this data will normally identify the type of fault, and in most cases will determine what corrective action must be taken. Refer to “Identifying an alarm” on page 1-4 to determine the remedial action required for a given fault.

The power amplifier stage contains an integral modular reserve (IMR) feature. This feature permits the transmitter to operate at a reduced RF output level when a malfunction occurs in one of its power modules. Station operating procedures will dictate whether a reduced RF output level is acceptable. When a reduced RF output level can be tolerated, replacement of the defective RF power module may be deferred to a convenient time.

A defective RF power module may be removed from the transmitter for servicing, while the transmitter is operating, provided that the conditions in the removal instructions detailed in “Removing an RF power module” on page 1-24 are met.

## OFF-AIR TROUBLESHOOTING

Off-air troubleshooting must be performed when the replacement of a defective RF power amplifier module, or routine on-air calibration adjustments, will not restore operation.

It is recommended that the transmitter's output be connected to a precision 50  $\Omega$  resistive dummy load (rated for at least the maximum transmitter power rating) before starting off-air troubleshooting procedures. If an appropriate dummy load is not available, troubleshooting for a majority of faults can be performed with RF power stage turned off. The transmitter may remain connected to its antenna system for these procedures.

**NOTE:**

*Reduce the RF output level to a minimal value when troubleshooting faults in the power amplifier stage while the transmitter's RF output is connected to the antenna system.*

## ELECTROSTATIC PROTECTION

The transmitter's assemblies contain semiconductor devices that are susceptible to damage from electrostatic discharge. The following precautions must be observed when handling an assembly which contains these devices.

**CAUTION:**

Electrostatic energy is produced when two insulating materials are rubbed together. A person wearing rubber-soled shoes, walking across a nylon carpet or a waxed floor, can generate an extremely large electrostatic charge. This effect is magnified during periods of low humidity. Semiconductor devices such as integrated circuits, field-effect transistors, thyristors and Schottky diodes may be damaged by this high voltage unless adequate precautions are taken.

## ELECTRICAL DISCHARGING OF PERSONNEL

Personnel should be electrically discharged by a suitable grounding system (e.g., anti-static mats, grounding straps) when removing an assembly from the transmitter, and while handling the assembly for maintenance procedures.

## HANDLING/STORAGE

An assembly should be placed in an anti-static bag when it is not installed in a host transmitter, or when it is not undergoing maintenance. Electronic components should be stored in anti-static materials.

## TOOLS/TEST EQUIPMENT

Testing and maintenance equipment – including soldering and unsoldering tools – should be suitable for contact with static sensitive semiconductor devices.

## STRESS CURRENT PROTECTION

Every precaution should be taken to ensure the static sensitive semiconductor devices are protected from unnecessary stress current. This is achieved by ensuring that *current is not flowing when an electrical connection is broken*, and that *voltages are not present on external control/monitoring circuits when they are connected*.

## IDENTIFYING AN ALARM

The best way to identify an alarm is by viewing the front panel's **Transmitter Status** page (Figure 1.1). If an alarm exists, the **Status** button at the bottom of the AUI display will be red. Press or click the **Status** button to go to the **Transmitter Status** page.

**Figure 1.1: Transmitter Status Page**

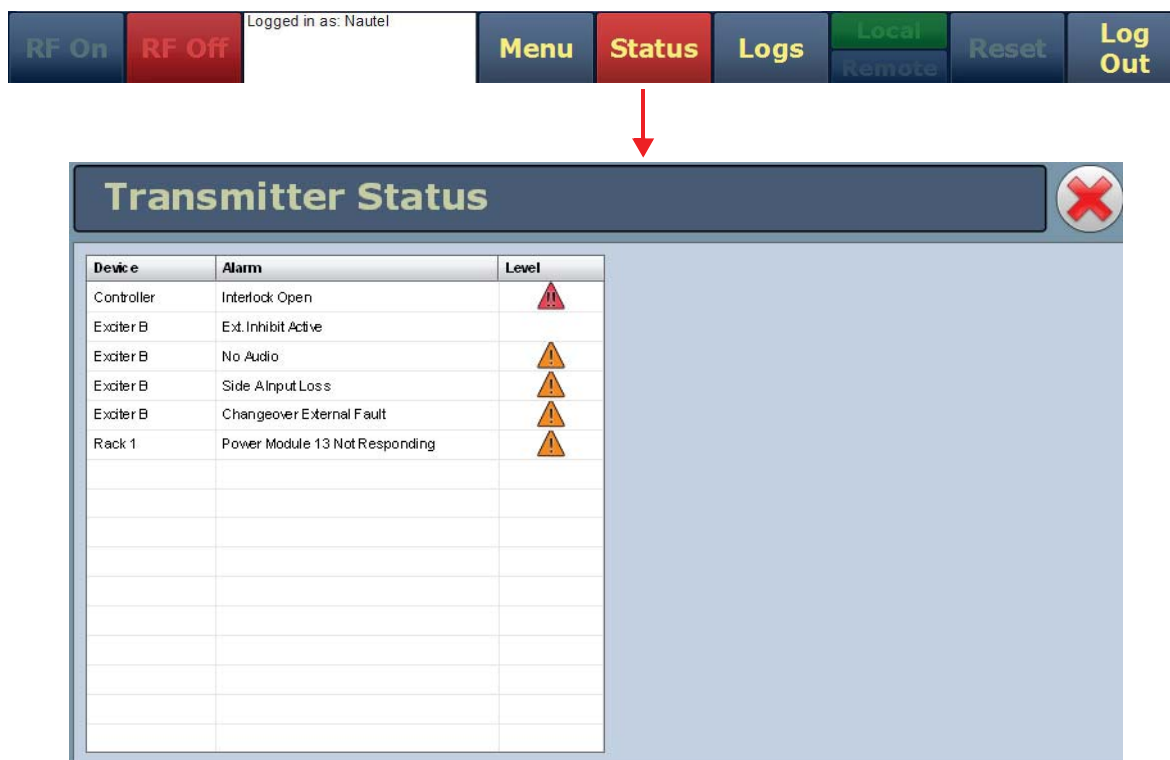

1. View the list of active faults by pressing the **Alarms** tab. Alarms are listed by their origin (**Device** column), then by name (**Alarm** column), and then by severity [a single yellow ! indicates low severity (RF output not affected), a single orange ! indicates medium severity (RF output is reduced), two red ! indicates high severity (RF output is inhibited); see **Level** column]. See “[List of current alarms](#)” on page 1-5.
2. Attempt to clear any latching alarms by pressing the **Reset** button on the bottom banner of the page. If the alarm persists, it will not be cleared from the display.
3. Refer to [Table 1.1 on page 1-6](#) for troubleshooting tips on the offending alarm(s), which may also reference replacement and subsequent re-calibration procedures. Note the origin of the alarm (i.e., contained within Controller, Exciter, Rack # or Module # sub-system folders).

4. If the troubleshooting and subsequent replacement of a suspect PWB or RF power module does not remove the fault condition, contact Nautel.

**NOTE:**

*Before undertaking any troubleshooting, record all AUI meter readings and note if any other alarms are displayed on the **Transmitter Status** page. Record all alarms. The most convenient way to do this is by using a web browser over a LAN connection to save screen shots of critical status, meter and alarm pages. From the **Meters** page, press the information (!) button for each sub-device (Controller, Exciter and Module) to view (and save) detailed information.*

## LIST OF CURRENT ALARMS

If an alarm exists and is being recognized by the transmitter, it is displayed under the **Alarms** tab of the transmitter status page (see [Figure 1.1 on page 1-4](#)). The **Device** name indicates the sub-system origin of the alarm. The sub-systems that can be displayed are:

- Controller: All alarms in this sub-system apply to the controller.
- Exciter A: All alarms in this sub-system apply to exciter A.
- Exciter B: All alarms in this sub-system apply to exciter B.
- Rack #: All alarms in this sub-system apply to the associated rack (or cabinet).
- Module #: All alarms in this sub-system apply to the associated RF power module.

[Table 1.1 on page 1-6](#) contains a column for most **Alarms** that can occur, sorted alphanumerically for each sub-system. The **Description and Troubleshooting Action** column provides a brief description of the alarm, troubleshooting tips and a cross-reference to more detailed troubleshooting, as applicable.

**Table 1.1: Troubleshooting Alarms**

Alarm (with Prefix)	Description and Troubleshooting Action
Controller: DRM Exciter Changeover	This event is caused by a fault related to the optional DRM exciter(s).
Controller: EEPROM Failure: Thresholds	This alarm occurs if there is no valid EEPROM threshold data to load. Remove and reapply the ac power to the transmitter. If the alarm persists after replacing the battery, replace the control/interface PWB (see <a href="#">“Control/interface PWB replacement”</a> on page 1-41).
Controller: EEPROM Failure: Potentiometers	This alarm occurs if there is no valid EEPROM potentiometers data to load. Remove and reapply the ac power to the transmitter. If the alarm persists after replacing the battery, replace the control/interface PWB (see <a href="#">“Control/interface PWB replacement”</a> on page 1-41).
Controller: EEPROM Failure: Schedule	This alarm occurs if there is no valid EEPROM schedule data to load. Remove and reapply the ac power to the transmitter. If the alarm persists after replacing the battery, replace the control/interface PWB (see <a href="#">“Control/interface PWB replacement”</a> on page 1-41).
Controller: Exciter Changeover	This event is caused by a fault in the active exciter while the automatic changeover function is enabled. No further exciter changeovers can occur until the fault is cleared. Check for associated alarm(s) that may have caused the changeover and refer to their troubleshooting action.
Controller: External PDM Inhibit	This alarm occurs if the external PDM inhibit, wired to the control/interface PWB, is active. Transmitter power is reduced to 0 W. See <a href="#">“Controller: External PDM Inhibit”</a> on page 1-20.
Controller: Firmware Checksum Failure	This alarm occurs if the Checksum for the firmware is in error. Remove and reapply the ac power to the transmitter. If the alarm persists after replacing the battery, replace the control/interface PWB (see <a href="#">“Control/interface PWB replacement”</a> on page 1-41).

Alarm (with Prefix)	Description and Troubleshooting Action
Controller: Host Network Down	This alarm indicates the transmitter is configured to have networking enabled, but the host is indicating there is no network connectivity. If the transmitter is not connected to a network, the alarm can be inhibited by changing the network settings to static IP and setting the IP address to 0.0.0.0. If the transmitter is connected to a network, verify the network settings are configured properly, and the network cable is connected to the correct port on the transmitter.
Controller: Host Not Booted	This alarm indicates that the controller has not received any communication from the host since the last time the controller booted (i.e., was powered up). The occurrence of this alarm is normal for approximately one to five minutes while the host is booting, immediately after ac power has been applied to the transmitter. If this alarm continues to occur more than 30 minutes after ac power has been applied to the transmitter, cycle (turn off, then on) the ac power. If the alarm persists after 30 minutes, replace the SBC or control/interface PWB (see <a href="#">“Control/interface PWB replacement” on page 1-41</a> ).
Controller: Host Not Responding	This alarm indicates that the controller has not received any communication from the host in a set period of time. The occurrence of this alarm is normal for approximately one to five minutes while the host is booting, immediately after ac power has been applied to the transmitter. If this alarm continues to occur more than 30 minutes after ac power has been applied to the transmitter, cycle (turn off, then on) the ac power. If the alarm persists after 30 minutes, replace the SBC or control/interface PWB (see <a href="#">“Control/interface PWB replacement” on page 1-41</a> ).
Controller: Interlock Open	The external interlock input wired to the control/interface PWB is open. An alarm will be triggered by user-set conditions (e.g., the state of the door to the transmitter room). See <a href="#">“Controller: Interlock Open” on page 1-20</a> .
Controller: Low Battery	This alarm occurs if the voltage of the backup battery has fallen below an acceptable level. Replace the battery (BT1) on the control/interface PWB while ac power is on. If the alarm persists after replacing the battery, replace the control/interface PWB (see <a href="#">“Control/interface PWB replacement” on page 1-41</a> ).

Alarm (with Prefix)	Description and Troubleshooting Action
Controller: Not Responding Exciter A	This alarm occurs if exciter A is not responding to serial messages. May cause an exciter changeover. Replace the digital AM exciter PWB of the exciter which is no longer responding (see <a href="#">“Digital AM exciter PWB replacement”</a> on page 1-36).
Controller: Not Responding Exgine	This alarm occurs if the optional Exgine PWB is not responding to serial messages. Replace the Exgine PWB (see <a href="#">“Exgine PWB replacement”</a> on page 1-42).
Controller: PDM Duty Cycle High	This alarm occurs if the duty cycle of the PDM drive on the active exciter is more than 10% above desired. Press RF Off, press the Reset button (S1) on the digital AM exciter PWB, then press RF On. If the alarm persists, replace the digital AM exciter PWB (see <a href="#">“Digital AM exciter PWB replacement”</a> on page 1-36).
Controller: PDM Duty Cycle Low	This alarm occurs if the duty cycle of the PDM drive on the active exciter is more than 10% below desired. Press RF Off, press the Reset button (S1) on the digital AM exciter PWB, then press RF On. If the alarm persists, replace the digital AM exciter PWB (see <a href="#">“Digital AM exciter PWB replacement”</a> on page 1-36).
Controller: PDM Latch	This alarm occurs if the duty cycle of the PDM drive on the active exciter is more than 95% steady state. Press RF Off, press the Reset button (S1) on the digital AM exciter PWB, then press RF On. If the alarm persists, replace the digital AM exciter PWB (see <a href="#">“Digital AM exciter PWB replacement”</a> on page 1-36).
Controller: RF Drive High	This alarm occurs if the duty cycle of the RF drive on the active exciter is more than 60%. PDM is inhibited and an exciter changeover occurs, if enabled. If the alarm persists, change over to the standby exciter. If this clears the alarm, there is likely a fault with one of the control/interface PWB's high speed comparators. Replace the control/interface PWB (see <a href="#">“Control/interface PWB replacement”</a> on page 1-41).
Controller: RF Drive Low	This alarm occurs if the duty cycle of the RF drive on the active exciter is less than 40%. PDM is inhibited and an exciter changeover occurs, if enabled. If the alarm persists, change over to the standby exciter. If this clears the alarm, there is likely a fault with one of the control/interface PWB's high speed comparators. Replace the control/interface PWB (see <a href="#">“Control/interface PWB replacement”</a> on page 1-41).



Alarm (with Prefix)	Description and Troubleshooting Action
Controller: Synch Changeover	This event is caused by a fault reported by the active exciter related to the optional 1 PPS, 10 MHz or 1 kHz synchronization signals.
Controller: Unknown PDM Inhibit	This alarm occurs if a PDM inhibit signal is active. It may be caused by an external PDM inhibit, an open interlock circuit, or another shutback source. Transmitter power is reduced to 0 W. Check for associated alarm(s) that may have caused the PDM inhibit and refer to their troubleshooting action.
Exciter A/B: AM Input Loss	This alarm occurs if the input signal being used to generate the analog AM modulation is low or not present. This alarm will be triggered immediately if the AES input is unlocked, or after 2 minutes if the incoming modulation level is below 10%. The presence of this alarm will trigger an exciter changeover if automatic changeover is enabled and the transmitter is operating on the main exciter. Verify that the active preset is calling up the correct audio input and is set for the correct input level. Verify that there is a valid audio signal on the audio input being used. If the alarm persists, replace the associated digital AM exciter PWB (see <a href="#">“Digital AM exciter PWB replacement”</a> on page 1-36).
Exciter A/B: Audio Overmod Protection	Due to a combination of audio and the current settings, too much power is being drawn from the transmitter. Decrease the audio input level until the alarm disappears.
Exciter A/B: B+ ADC Overflow	The B+ sample voltage is too high, causing clipping in the ADC. B+ compensation will be unreliable.
Exciter A/B: Cutback Active	The forward power has been reduced due to multiple shutbacks.

Alarm (with Prefix)	Description and Troubleshooting Action
Exciter A/B: Digital Input Loss	This alarm indicates the input signal being used to generate the digital modulation is too low or no longer present. This alarm will be triggered immediately if the AES input (DRM) is unlocked or the Exgine stream (IBOC) is missing, or if the DSP is receiving zeroes on the AES (DRM) or Exgine (IBOC) input for more than 100 ms. The presence of this alarm will trigger an exciter changeover, if automatic changeover is enabled and the transmitter is operating on the main exciter. Verify that the active preset is calling up the correct input and is set for the correct input level. Verify that there is a valid signal on the input being used. If the alarm persists, replace the associated digital AM exciter PWB (see <a href="#">“Digital AM exciter PWB replacement” on page 1-36</a> ).
Exciter A/B: External Inhibit Active	An externally generated PDM inhibit (via the control/interface PWB) is active. Transmitter power is reduced to 0 W.
Exciter A/B: FPGA Test Failed	There was a programming failure with the FPGA. Possibly indicates a fault with the control/interface PWB. Cycle the power (off, then on) to the affected exciter. If the alarm persists, replace the affected digital AM exciter PWB (see <a href="#">“Digital AM exciter PWB replacement” on page 1-36</a> ).
Exciter A/B: High B+ Voltage	This alarm indicates that the B+ voltage measured by the exciter exceeded the B+ setpoint by more than 20 V for at least ten (10) seconds. If the rack interface’s High B+ voltage alarm is present, see the troubleshooting action for that alarm. If the rack interface’s alarm is not present, compare the exciter’s B+ voltage meter with the rack’s B+ voltage meter. If they are different, calibrate the exciter’s B+ voltage sample using a multimeter to measure the B+ voltage. If after calibrating the exciter’s B+ voltage sample the meters continue to read the incorrect voltage, replace the associated digital AM exciter PWB (see <a href="#">“Digital AM exciter PWB replacement” on page 1-36</a> ).
Exciter A/B: High Current Foldback Active	The forward power has been reduced due to a high level of RMS RF current. Decrease the transmitter’s power level until the alarm disappears and/or check the transmitter’s output network.
Exciter A/B: High DC Current Foldback Active	The forward power has been reduced due to a high level of RMS dc current.

Alarm (with Prefix)	Description and Troubleshooting Action
Exciter A/B: High Fwd Foldback Active	The forward power has been reduced due to a high level of RMS forward power. Decrease the transmitter's power level until the alarm disappears and/or check the transmitter's output network.
Exciter A/B: High Temperature Foldback Active	The forward power has been reduced due to excessive temperature in the RF power modules or SCR rectifiers. Check the transmitter's output network and verify that the air filters in the back of each cabinet are clean. Verify the temperature of the transmitter building is within specifications.
Exciter A/B: Low B+ Voltage	This alarm occurs when the B+ voltage measured by the exciter drops below 75% of the B+ setpoint for more than 10 seconds. When this alarm is present the exciter will not allow the PDM duty cycle to be increased to compensate for fluctuations in B+. This alarm will clear when the B+ voltage measurement exceeds 81.25% of the B+ setpoint. Generally this alarm indicates that the B+ voltage cannot be increased because the ac voltage is too low. Check the ac mains voltage connected to the transmitter and verify the power transformer is tapped correctly.
Exciter A/B: Main PLL Unlocked	The main clock source has unlocked. Usually accompanied by No Ext 10 MHz. Cycle the power (off, then on) to the affected exciter. If the alarm persists, replace the affected digital AM exciter PWB (see <a href="#">"Digital AM exciter PWB replacement" on page 1-36</a> ).
Exciter A/B: Missed FPGA Watchdog	The DSP software failed to synchronize with the FPGA.
Exciter A/B: No AES1 or AES2 Lock	This alarm indicates there is no AES data detected on the applicable AES (1 or 2) input and that same input is selected as the active input in either Analog or Digital settings for the active preset. Verify there is valid AES data being applied to the corresponding input on the control/interface PWB. If there is data being applied to the correct input and the alarm persists, replace the digital AM exciter PWB (see <a href="#">"Digital AM exciter PWB replacement" on page 1-36</a> ) or the control/interface PWB (see <a href="#">"Control/interface PWB replacement" on page 1-41</a> ).
Exciter A/B: No B+ Sample	The B+ sample voltage is missing or is extremely low. If this alarm is accompanied by another alarm, troubleshoot the other alarm first. If the alarm occurs on its own, replace the affected digital AM exciter PWB (see <a href="#">"Digital AM exciter PWB replacement" on page 1-36</a> ).

Alarm (with Prefix)	Description and Troubleshooting Action
Exciter A/B: No Current Sample	The RF current sample voltage is missing or is extremely low. If the standby exciter does not indicate this alarm, replace the affected digital AM exciter PWB (see <a href="#">“Digital AM exciter PWB replacement” on page 1-36</a> ). If both exciters indicate this alarm, replace the affected digital AM exciter PWB (see <a href="#">“Control/interface PWB replacement” on page 1-41</a> ).
Exciter A/B: No Digital AES Lock	No AES stream is detected on the digital AES input. Check the audio input.
Exciter A/B: No Ext 10 MHz	No 10 MHz is detected on the external 10 MHz input. Check the 10 MHz input.
Exciter A/B: No IBOC Data	This alarm indicates there is no modulation data being provided by the embedded Exgine when the transmitter is running in an IBOC mode of operation. This alarm will trigger the Digital Input Loss alarm. Verify the transmitter is operating in the intended mode. Verify the embedded Exgine is connected to the control/interface PWB and the wiring connections are intact. Verify the Exporter is connected to the Exgine and the Exgine is receiving data from the Exporter. If the alarm persists, replace the associated digital AM exciter PWB (see <a href="#">“Digital AM exciter PWB replacement” on page 1-36</a> ) or the Exgine PWB (see <a href="#">“Exgine PWB replacement” on page 1-42</a> ).
Exciter A/B: No Voltage Sample	There is a fault with the transmitter’s voltage probe. If the standby exciter does not indicate this alarm, replace the affected digital AM exciter PWB (see <a href="#">“Digital AM exciter PWB replacement” on page 1-36</a> ). If both exciters indicate this alarm, replace the affected digital AM exciter PWB (see <a href="#">“Control/interface PWB replacement” on page 1-41</a> ).
Exciter A/B: Over Current Shutback	The RF current is above its factory-set threshold. Check the output network.
Exciter A/B: Over Voltage Shutback	The RF voltage is above its factory-set threshold. Check the output network.
Exciter A/B: PDM Inhibited	An internally generated PDM inhibit (from the DSP) is active. Transmitter power is reduced to 0 W.
Exciter A/B: Power Below Setpoint	The power set point cannot be attained, due to a foldback, RF power module failure(s), or a load impedance mismatch.

Alarm (with Prefix)	Description and Troubleshooting Action
Exciter A/B: SWR Shutback	The reflected power is above its factory-set threshold - approximately 816 kW. Check the output network.
Exciter A/B: VSWR Foldback Active	The forward power has been reduced due to a high VSWR. Check the output network.
Module #: Bad RF Drive	The duty cycle of the RF drive or the dead time between RF drive phases is not as expected. See <a href="#">“Troubleshooting RF power modules” on page 1-29</a> to determine whether to replace the affected RF power module or to repair damaged parts.
Module #: Close RF Relay	Status that indicates the RF power module’s shorting relay contact is closed.
Module #: Disable PDM	Status that indicates the PDM drive in the RF power module is disabled.
Module #: EEPROM Failure	There is no valid EEPROM data to load. See <a href="#">“Removing and reinstalling RF power modules” on page 1-24</a> to replace the affected RF power module.
Module #: External Disable Active	The PDM drive cable is unplugged. Reconnect or replace the PDM drive cable. If the problem persists, replace the affected RF power module (see <a href="#">“Removing and reinstalling RF power modules” on page 1-24</a> ). If the problem persists, replace the PDM drive distribution PWB (see <a href="#">“RF drive distribution PWB replacement” on page 1-44</a> ).
Module #: Fan Speed 1 (or 2) Low	The specified fan below the specified RF power module is rotating at a speed less than 3000 RPM. If multiple RF power modules (from the same column) report this alarm, replace the associated fan tray assembly (see <a href="#">“RF Power Module Fan Tray replacement” on page 1-51</a> ). If only one RF power module reports this alarm, replace the affected RF power module (see <a href="#">“Removing and reinstalling RF power modules” on page 1-24</a> ).
Module #: High B+ Voltage	This alarm indicates the RF power module's B+ meter has exceeded 450 V. If high B+ voltage alarms are present for other system components, see the troubleshooting action for those alarms. If the alarm persists, replace the RF power module (see <a href="#">“Removing and reinstalling RF power modules” on page 1-24</a> ).

Alarm (with Prefix)	Description and Troubleshooting Action
Module #: High DC Current	This alarm occurs if the dc current in the RF power module is above 20 A. See <a href="#">“Troubleshooting RF power modules” on page 1-29</a> to determine whether to replace the affected RF power module or to repair damaged parts.
Module #: High PA Volts	The PA voltage is at least 10% above the product of the B+ level and the PDM duty cycle (and the PDM duty cycle is at least 10%). See <a href="#">“Troubleshooting RF power modules” on page 1-29</a> to determine whether to replace the affected RF power module or to repair damaged parts.
Module #: High RF Drive	The duty cycle of the RF drive on the active exciter is more than 50%. PDM is inhibited. See <a href="#">“Troubleshooting RF power modules” on page 1-29</a> to determine whether to replace the affected RF power module or to repair damaged parts.
Module #: High Temperature	The temperature of the RF power module is more than 90°C (194°F). If this alarm is accompanied by another alarm, troubleshoot the other alarm first. If the alarm occurs on its own, see <a href="#">“Troubleshooting RF power modules” on page 1-29</a> to determine whether to replace the affected RF power module or to repair damaged parts.
Module #: Invalid Thermistor Sample	A sample of the heatsink temperature is monitored. An alarm occurs if the sample is below an acceptable level for monitoring. See <a href="#">“Troubleshooting RF power modules” on page 1-29</a> to determine whether to replace the affected RF power module or to repair damaged parts.
Module #: Low B+ Voltage	The B+ voltage is at least 10% below its expected level. Replace the fuse on the power module interface PWB for the affected RF power module (see <a href="#">“Module #: Low B+ voltage” on page 1-22</a> ). See <a href="#">“Troubleshooting RF power modules” on page 1-29</a> to determine whether to replace the affected RF power module or to repair damaged parts.
Module #: Low Voltage Supply Fault	The voltage of the +15 V or +5 V power supply is more than its specified limits.

Alarm (with Prefix)	Description and Troubleshooting Action
Module #: Low PA Volts	The PA voltage is at least 10% below the product of the B+ level and the PDM duty cycle (and the PDM duty cycle is at least 10%). See <a href="#">“Troubleshooting RF power modules” on page 1-29</a> to determine whether to replace the affected RF power module or to repair damaged parts.
Module #: Low RF Drive	The duty cycle of the RF drive on the active exciter is less than 35%. PDM is inhibited. See <a href="#">“Troubleshooting RF power modules” on page 1-29</a> to determine whether to replace the affected RF power module or to repair damaged parts.
Module #: No Serial Comms	There is no serial communication with the RF power module. See <a href="#">“Removing and reinstalling RF power modules” on page 1-24</a> to replace the affected RF power module.
Module #: Overmodulation	The average PDM duty cycle is more than 95%. If PDM is enabled, the High DC Current alarm will occur first.
Module #: PDM Enabled	Status that indicates the PDM drive in the RF power module is enabled.
Module #: Residual PA Volts	An unexpected level of PA voltage is detected when the modulator or PA of a specific RF power module is disabled. See <a href="#">“Troubleshooting RF power modules” on page 1-29</a> to determine whether to replace the affected RF power module or to repair damaged parts.
Module #: RF Drive Enabled	Status that indicates the RF drive in the RF power module is enabled.
Module #: RF Relay Open	Status that indicates the RF power module’s shorting relay contact is open.
Module #: Serial RF OFF	Status that indicates the RF power module is in an RF off state.
Rack #: AC Phase Loss	The SCR rectifier assembly detects a phase loss on the ac input. Check the ac mains fuses for a phase loss. If the ac mains phases are OK, replace the SCR rectifier assembly (U1) (see <a href="#">“SCR Rectifier Inspection/Replacement” on page 1-47</a> ).
Rack #: EEPROM Failure	There is no valid EEPROM data to load. Remove and reapply the ac power to the transmitter. If the alarm persists, replace the rack interface PWB (see <a href="#">“Rack Interface PWB replacement” on page 1-45</a> ).

Alarm (with Prefix)	Description and Troubleshooting Action
Rack #: Firmware Checksum Failure	The Checksum for the firmware is in error. Remove and reapply the ac power to the transmitter. If the alarm persists, replace the rack interface PWB (see <a href="#">“Rack Interface PWB replacement” on page 1-45</a> ).
Rack #: High B+ Voltage	If the B+ voltage is more than 10 V above the B+ voltage set point, the rack interface will attempt to decrease the rectifier’s output. If the rack interface reaches the bottom of its adjustment range and the B+ voltage remains 10 V or more above the B+ voltage setpoint for more than 15 seconds, this alarm will occur. The alarm will clear when the B+ voltage changes to within 10 V of the B+ voltage setpoint, or the B+ power supply is inhibited (by turning RF Off, for example). If the alarm persists while the transmitter is producing RF power, replace the rack interface PWB (see <a href="#">“Rack Interface PWB replacement” on page 1-45</a> ).
Rack #: Low AC	A sample of the power transformer’s secondary voltage is monitored. An alarm occurs if the ac input voltage is more than 45% below nominal. See <a href="#">“Rack #: Low AC” on page 1-23</a> .
Rack #: Low B+ Shutdown	This alarm indicates that the B+ decreases more than 126 V below the B+ setpoint. While this alarm is active, the rectifier and exciter PDM outputs will be inhibited. This alarm will clear if the measured ac voltage on the transformer secondary increases above 263 Vac line-to-line after a minimum one (1) second delay or if the transmitter is turned RF Off. If the alarm persists, check the ac mains voltage and verify they are within the nominal voltage the transmitter is tapped for $\pm 10\%$ . Verify the mains transformer is tapped correctly. With RF On at low power, verify the B+ voltage is 400 V (or per the B+ setpoint if adjusted). If not, replace the rectifier. Otherwise suspect the rack interface PWB (see <a href="#">“Rack Interface PWB replacement” on page 1-45</a> ).



Alarm (with Prefix)	Description and Troubleshooting Action
Rack #: Low B+ Voltage	If the B+ voltage falls to more than 15% below the B+ voltage set point, the rack interface will attempt to turn up the rectifier output voltage. If the rack interface reaches the top of its adjustment range and the B+ voltage remains 25% or more below the B+ voltage setpoint for more than two (2) seconds, this alarm will occur. The alarm will clear when the B+ voltage changes to within 25% of the B+ voltage setpoint, or the B+ power supply is inhibited (by turning RF Off, for example). If the alarm persists while the transmitter is producing RF power, check the ac mains voltages and verify they are within $\pm 10\%$ of the nominal voltage for which the transformer is tapped. If the alarm persists, replace the rack interface PWB (see <a href="#">“Rack Interface PWB replacement”</a> on page 1-45).
Rack #: Not Responding Module #	This alarm occurs if one or more of the 2040 RF power modules is not responding to serial messages. Try swapping the affected module with a module in another location (see <a href="#">“Removing and reinstalling RF power modules”</a> on page 1-24). If the alarm follows the module, replace the module. If the alarm follows the location, check the connections between the module location and its associated power module interface PWB and rack interface PWB.
Rack #: Rectifier Fan 1 (or 2) Fail	This alarm occurs if the speed of one of the SCR rectifier’s cooling fans is below 1650 RPM (half its nominal value of 3300 RPM). Inspect the affected fan and, if necessary, replace it (see <a href="#">“SCR Rectifier Inspection/Replacement”</a> on page 1-47).
Rack #: +15 V Fail	This alarm occurs if either +15 V power supply’s rail is outside the acceptable range (13.5 V to 16.5 V). Replace the affected 15 V power supply (see <a href="#">“Low Voltage Power Supply Replacement”</a> on page 1-49).
Rack #: +15 V PS A (or B) Fault	The digital fault reporting output of either +15 V power supply (U3 or U4) is active. Replace the affected 15 V power supply (see <a href="#">“Low Voltage Power Supply Replacement”</a> on page 1-49).
Rack #: -15 V PS (A or B) Fault	This alarm occurs if the -15V rail is outside its acceptable range of -13.5 to -16.5 V. Suspect a faulty dc-dc converter (U22 for A or U25 for B) on the rack interface PWB. Remove the rack interface PWB (see <a href="#">“Rack Interface PWB replacement”</a> on page 1-45) and replace the defective dc-dc converter or the entire rack interface PWB.

---

Alarm (with Prefix)	Description and Troubleshooting Action
Rack #: +30 V PS Fault	This alarm occurs if the +30 V rail has varied outside its acceptable range of 27 to 33 V. Suspect a faulty dc-dc converter (U11 for A or U14 for B) on the rack interface PWB. Remove the rack interface PWB (see <a href="#">“Rack Interface PWB replacement” on page 1-45</a> ) and replace the defective dc-dc converter or the entire rack interface PWB.
Rack #: +48 V Fail	This alarm occurs if either +48 V power supply’s rail is outside the acceptable range (44 V to 52 V). Replace the affected 15 V power supply (see <a href="#">“Low Voltage Power Supply Replacement” on page 1-49</a> ).
Rack #: +48 V PS A (or B) Fault	The +48 V power supplies (U5 and U6) are monitored. An alarm occurs if the power supply voltage varies outside its acceptable range of 44 to 52 V. Replace the affected 48 V power supply (see <a href="#">“Low Voltage Power Supply Replacement” on page 1-49</a> ).
Rack #: +5 V PS (A or B) Fault	This alarm occurs if the +5 V rail is outside its acceptable range of 4.8 to 5.6 V. Suspect a faulty dc-dc converter (U2 for A or U4 for B) on the rack interface PWB. Remove the rack interface PWB (see <a href="#">“Rack Interface PWB replacement” on page 1-45</a> ) and replace the defective dc-dc converter or the entire rack interface PWB.

**Table 1.2: Module Replacement Procedures**

<b>Module</b>	<b>Replacement Procedure</b>
RF Power Module	See <a href="#">page 1-24</a>
Power Amplifier MOSFET	See <a href="#">page 1-32</a>
Modulator MOSFET	See <a href="#">page 1-34</a>
Remote Interface PWB	See <a href="#">page 1-36</a>
Digital AM Exciter PWB	See <a href="#">page 1-36</a>
Control/Interface PWB	See <a href="#">page 1-41</a>
GPS Sync PWB	See <a href="#">page 1-42</a>
Exgine PWB	See <a href="#">page 1-42</a>
PDM Distribution PWB	See <a href="#">page 1-43</a>
RF Drive Distribution PWB	See <a href="#">page 1-44</a>
Rack Interface PWB	See <a href="#">page 1-45</a>
Low Voltage Power Supplies	See <a href="#">page 1-49</a>
RF Power Module Fan Tray	See <a href="#">page 1-51</a>

## RESPONDING TO ALARMS

### CONTROLLER: EXTERNAL PDM INHIBIT

The external PDM inhibit is wired to the control/interface PWB.

A **Controller: External PDM Inhibit** alarm indicates that an external PDM inhibit command is present. The alarm could be caused by an short circuit in the external wiring path to the control/interface PWB or a fault in the switching circuitry on the control/interface PWB. Troubleshoot as follows:

1. If the control/interface PWB's shorting jumper E2 is in the **INT** position (shorting pins 2 and 3), verify the dc voltage between J6-4 and ground on the control/interface PWB is approximately 15 V. This signifies there is no external PDM inhibit command.
2. If the control/interface PWB's shorting jumper E2 is in the **EXT** position (shorting pins 1 and 2), verify the dc voltage between J6-3 and J6-4 on the control/interface PWB is 0 V. This signifies there is no external PDM inhibit command.
3. If the conditions in [Step 1](#) and [Step 2](#) are met, suspect the control/interface PWB and if necessary, replace it (see "[Control/interface PWB replacement](#)" on page 1-41).

### CONTROLLER: INTERLOCK OPEN

A **Controller: Interlock Open** alarm indicates an external interlock is open. The transmitter's RF output will be inhibited.

The external interlock input is wired to the control/interface PWB by the end user and triggered by the conditions that they set (e.g., the state of the door to the transmitter room).

1. Gain access to the control/exciter panel (A11) (see [Figure 1.6 on page 1-35](#)) by opening the control cabinet's front door. The door is not latched and just swings open to the left.
2. Connect a digital multimeter (set to measure dc) between J6-2 of the control/interface PWB and ground.
3. If 15 V is present on J6-2, the external interlock circuit is intact and the probable cause of the alarm is a defective monitoring circuit. Suspect the control/interface PWB and if necessary, replace it (see "[Control/interface PWB replacement](#)" on page 1-41).
4. If 15 V is not present on J6-2, measure the voltage between J6-5 (external 15 V) of the control/interface PWB and ground, then between J6-1 (+15 V) and ground.

5. If 15 V is present on J6-5 and J6-1, the external interlock circuit is open (normally caused by an open interlock switch).

## MODULE FAULTS

There are many alarms on the AUI, prefixed by the text **Module**, that indicate faults related to one or more of the 2040 RF power modules in a cabinet. The number that appears after Module or PM, identifies the serial identification of the affected RF power module. These serial numbers are labeled on the front panel of each RF power module.

1. Check the forward power reading on the AUI. If it is less than the preset level, one or more RF power modules are defective. Proceed to “[RF power module fault validation](#)”.
2. If the forward power reading in [Step 1](#) is normal press the **Transmitter Status** button on the AUI to check for other alarms that may have triggered the RF power module alarm.

### RF POWER MODULE FAULT VALIDATION

Each RF power module has a multi-colour LED on its front panel, which can help in identifying a fault and allowing you to determine whether remedial action is required now or later.

Identify and isolate a defective RF power module, and verify the nature of the defect by checking the LEDs on the RF power modules’ front panels. Note which RF power module is not operating normally and producing RF power (i.e., LED is not solid green). Record which RF power modules are displaying an alarm and the state of its LED (see below).

- amber, off: module is RF off
- solid red: module has a non-latching alarm
- flashing red, then green: module is producing RF, but has an alarm
- long red, short amber: module has a latching alarm
- long red, short off: module has no valid serial number
- short red, long off: module has no valid serial address on the internal bus
- long amber, short green: module is producing RF, but no serial communications
- long amber, short red: module is not producing RF and no serial communications

Except in the case of a **High DC Current**, **High PA Volts** and **Residual PA Volts** alarm, attempt to reset an RF power module by disconnecting and reconnecting the RJ45 plug in the front of the module. If you cannot reset the front panel LED alarm, see “[RF power module troubleshooting](#)”.

## RF POWER MODULE TROUBLESHOOTING

Refer to “[Removing and reinstalling RF power modules](#)” on page 1-24 for removal and installation instructions and then refer to “[Troubleshooting RF power modules](#)” on page 1-29 for detailed troubleshooting information.

**NOTE:**

*A defective RF power module can be removed for repair, without turning off the transmitter, as described in “[Removing an RF power module](#)” on page 1-24. The transmitter can be operated at a reduced output power level with an RF power module removed.*

## MODULE #: LOW B+ VOLTAGE

A **Module # Low B+ Voltage** alarm is triggered when the B+ voltage is at least 10% below its expected level.

1. If all RF power modules are reporting this alarm, it is very likely there is also a **Rack #: Low B+** alarm. If so, the fault is not likely associated with an RF power module; proceed to “[Rack #: Low AC](#)” on page 1-23 for further troubleshooting information. If not, proceed to [Step 2](#).
2. Check and, if necessary, replace the the fuse on the power module interface PWB for the affected RF power module. Each power module interface PWB serves four RF power modules and therefore has four B+ fuses (F1 through F4). Refer to Figures MD-1 and MD-2 in the Mechanical Drawings section of this manual to locate the associated power module interface PWB and then refer to Figure MD-4 or MD-5 to locate the specific fuse.
3. Check and, if necessary, replace the affected RF power module. See “[Troubleshooting RF power modules](#)” on page 1-29.

---

## RACK #: LOW AC

A **Rack # (1-8): Low AC** alarm is triggered when the ac input voltage is at least 45% below its expected level. Recovery from this alarm is automatic when the ac voltage rises to an acceptable level.

**NOTE:**

*An NX100 transmitter has only one rack (or cabinet) and will only display Rack 1.*

If the transmitter does not automatically recover from this alarm, the low ac voltage is normally caused by low ac mains voltage or improper primary taps on the power transformer. Troubleshoot a **Rack #: Low AC** alarm as follows.

**WARNING:**

**LETHAL VOLTAGES EXIST IN THE POWER SUPPLY COMPARTMENT OF THE TRANSMITTER. USE EXTREME CAUTION IN THIS AREA.**

1. Measure the ac input voltage and verify the power transformer is tapped as shown in [Section 4, “Connecting transformer taps/load wiring”](#) on page 4-1 of the *NX100 Installation Manual*. If necessary, turn off the transmitter, lock out the ac input voltage and retap the power transformer for the next highest voltage.
2. If the transformer taps are correct, the monitoring circuit is suspect. Contact Nautel for troubleshooting information.

## REMOVING AND REINSTALLING RF POWER MODULES

### REMOVING AN RF POWER MODULE

1. Confirm the location of the RF power module that is being removed. Note the alarm text includes a Module serial address that is also identified on the front panel of each RF power module. See [Figure 1.3 on page 1-27](#) to determine the location for a given RF power module (A15A20 through A34A59).
2. If possible, turn off the transmitter before removing an RF power module. If you need to remove a module while “on air”, disable the RF power module to be removed using the AUI. From the Meters page, click on the Rack information (i) button. The Power Module status screen (see [Figure 1.2 on page 1-25](#)) should appear. Click on the associated RF power module’s Front Panel Inhibit icon. The icon colour should change from green to red, indicating the RF power module is disabled.
3. After the RF power module is disabled, you should hear a relay in the back of the cabinet drop out (de-energize). If you do not hear the relay de-energize (click), **DO NOT CONTINUE** to [Step 4](#). Try re-enabling and disabling a few times while trying to hear the relay de-energize. If you do not hear the sound, **DO NOT** remove the RF power module while the transmitter is on-air..
4. Disconnect the RJ45 cable from the front of the RF power module. If the module was not disabled in [Step 2](#), you should now hear a relay in the back of the cabinet drop out (de-energize)
5. Remove both mounting screws from the RF power module’s front panel.
6. Grasp the handle on the front of the RF power module and carefully pull the RF power module out of the transmitter.



Figure 1.2: Disabling/Enabling an RF Power Module

	PM 1	PM 2	PM 3	PM 4	PM 5	PM 6	PM 7	PM 8	PM 9	PM 10
Front Panel Inhibit	Enabled	Enabled	Enabled	Enabled	Enabled	Enabled	Enabled	Enabled	Enabled	Enabled
Serial Address	12DB	12D9	12D4	12CA	12D3	12DC	12D7	12C9	12D1	12D0
DC Current	0 A	0 A	0 A	0 A	0 A	0 A	0 A	0 A	0 A	0 A
B+ Voltage	0 V	0 V	0 V	0 V	0 V	0 V	0 V	0 V	0 V	0 V
PDM Duty Cycle	0 %	0 %	0 %	0 %	0 %	0 %	0 %	0 %	0 %	0 %
PA Volts	0 V	0 V	0 V	0 V	0 V	0 V	0 V	0 V	0 V	0 V
Low Voltage Supply	15.1 V	15.0 V	15.1 V	15.0 V	15.1 V	15.1 V	15.1 V	15.2 V	15.2 V	15.1 V
RF Drive Duty Cycle	43.2 %	43.4 %	43.4 %	43.4 %	43.4 %	43.3 %	43.2 %	43.4 %	43.5 %	43.4 %
Temperature	24.0 °C	23.5 °C	24.4 °C	24.4 °C	23.5 °C	24.8 °C	24.4 °C	24.0 °C	24.0 °C	24.4 °C
Fan 1 Speed	0 rpm	0 rpm	0 rpm	0 rpm	0 rpm	0 rpm	0 rpm	0 rpm	0 rpm	0 rpm
Fan 2 Speed	0 rpm	0 rpm	0 rpm	0 rpm	0 rpm	0 rpm	0 rpm	0 rpm	0 rpm	0 rpm

Green indicates enabled. Click to disable (will turn red); click again to re-enable (will turn green)

## INSTALLING AN RF POWER MODULE

1. If possible, turn off the transmitter before installing an RF power module. Grasp the handle on the front of the RF power module and insert it into the transmitter.
2. Carefully push the RF power module into place so that its card-edge connector mates with the transmitter.
3. Install both mounting screws in the RF power module's front panel.
4. Connect the RJ45 cable to the front of the RF power module. If you are installing the RF power module while the transmitter is "on-air", click on the associated RF power module's **Front Panel Inhibit** icon as shown in [Figure 1.2](#). The icon colour should change from red to green, indicating the RF power module is enabled. You should hear a relay in the back of the transmitter pick up (energize).
5. Upgrade the subsystem software using the AUI's **Upgrade Software** page under the **System Settings** menu. See the *NX100 Operations and Maintenance Manual* for detailed instructions.

Figure 1.3: RF Power Module Locations

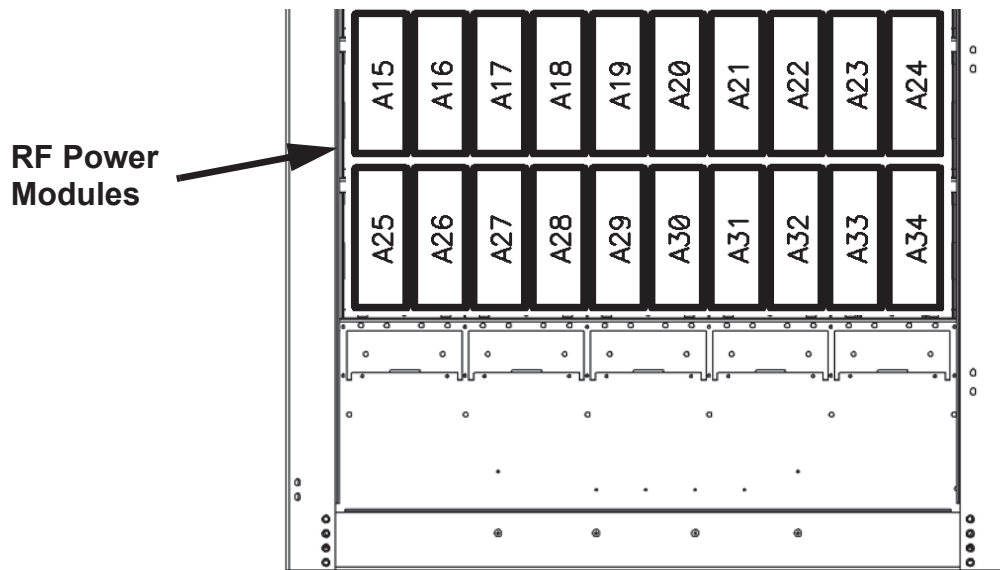

Front Door Removed for Clarity

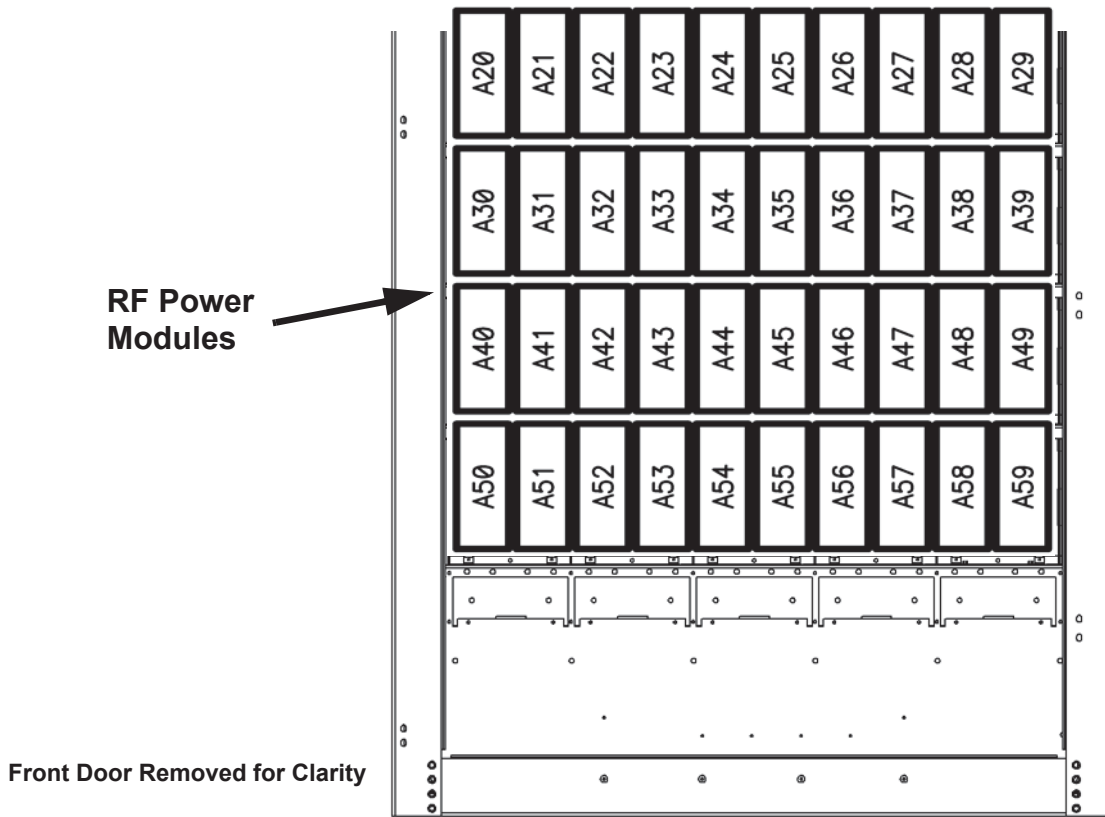

## TROUBLESHOOTING RF POWER MODULES

### MAINTENANCE PHILOSOPHY

Recommended troubleshooting procedures for RF power modules are limited to “go” or “no-go” resistance or diode measurements on the module’s power semi-conductors and replacement procedures for these devices.

### SPECIAL TOOLS AND TEST EQUIPMENT

The following test equipment and cables are required to troubleshoot an RF power module.

- A digital multimeter with resistance and diode settings.
- A torque screwdriver with a torque range of 0.0 to 2.26 N-m (0 - 20 in.-lbs). Required for installing MOSFET attaching hardware.
- A soldering iron and desoldering tool.
- An NX100 spares kit (contains replacement semi-conductors).

### ELECTROSTATIC PRECAUTIONS

The RF power module contains semiconductor devices that are susceptible to damage from electrostatic discharge. Be sure to follow the electrostatic precautions in [“Electrostatic protection”](#) on [page 1-3](#) at all times.

### PREPARATION FOR TROUBLESHOOTING

1. Follow the procedure in [“Removing an RF power module”](#) on [page 1-24](#) to remove the RF power module from the transmitter.
2. Place the RF power module on a suitable work surface.
3. Perform the resistance measurements on the modulator and power amplifier MOSFETs as described in [“Resistance measurements”](#) on [page 1-30](#).
4. Perform the diode checks on the free-wheel diodes as described in [“Power Amplifier FET replacement”](#) on [page 1-32](#)

---

## RESISTANCE MEASUREMENTS

Complete the following resistance measurements for each suspect RF power module. See [Figure 1.4 on page 1-31](#) to identify the power MOSFETs on the RF power module.

1. Remove fuse F1 from its holder and measure its resistance using a digital multimeter. A blown fuse will measure an open circuit. If the fuse is OK, return it to its holder.
2. For each power amplifier MOSFET (Q7 through Q10) and each modulator MOSFET (Q11, Q12 and Q13), use a digital multimeter to make the following resistance measurements. Note that Q7 through Q10 have screw-head terminals and Q11 through Q13 have solder pads (see [Figure 1.4 on page 1-31](#)):
  - Check for 1,000  $\Omega$  between the gate and source.
  - Check for an open circuit between the gate and drain.
3. If either measurement in [Step 2](#) is not satisfactory, replace the affected power amplifier MOSFET (see “[Power Amplifier FET replacement](#)”) or modulator MOSFET (see “[Modulator FET replacement](#)” on page 1-34).
4. If both measurements in [Step 2](#) are satisfactory, replace the entire RF power module (see “[Removing and reinstalling RF power modules](#)” on page 1-24).

## DIODE CHECKS

Complete the following diode checks for each suspect RF power module. See [Figure 1.4 on page 1-31](#) to identify the free-wheel diode on the RF power module.

1. Use a digital multimeter (on its diode setting) to check free-wheel diode CR8, noting the anode (A) and cathode (K) markings (see [Figure 1.4 on page 1-31](#)):
2. If the diode is not satisfactory, replace the it by desoldering its surface-mount leads and case from the PWB. Locate a replacement diode (Nautel Part # QM54) in the spares kit, if purchased, and solder it to the PWB, noting correct orientation.
3. If the diode is satisfactory, proceed to MOSFET replacement, as necessary, or replace the entire RF power module (see “[Removing and reinstalling RF power modules](#)” on page 1-24).

Figure 1.4: RF Power Module MOSFET and Diode Location

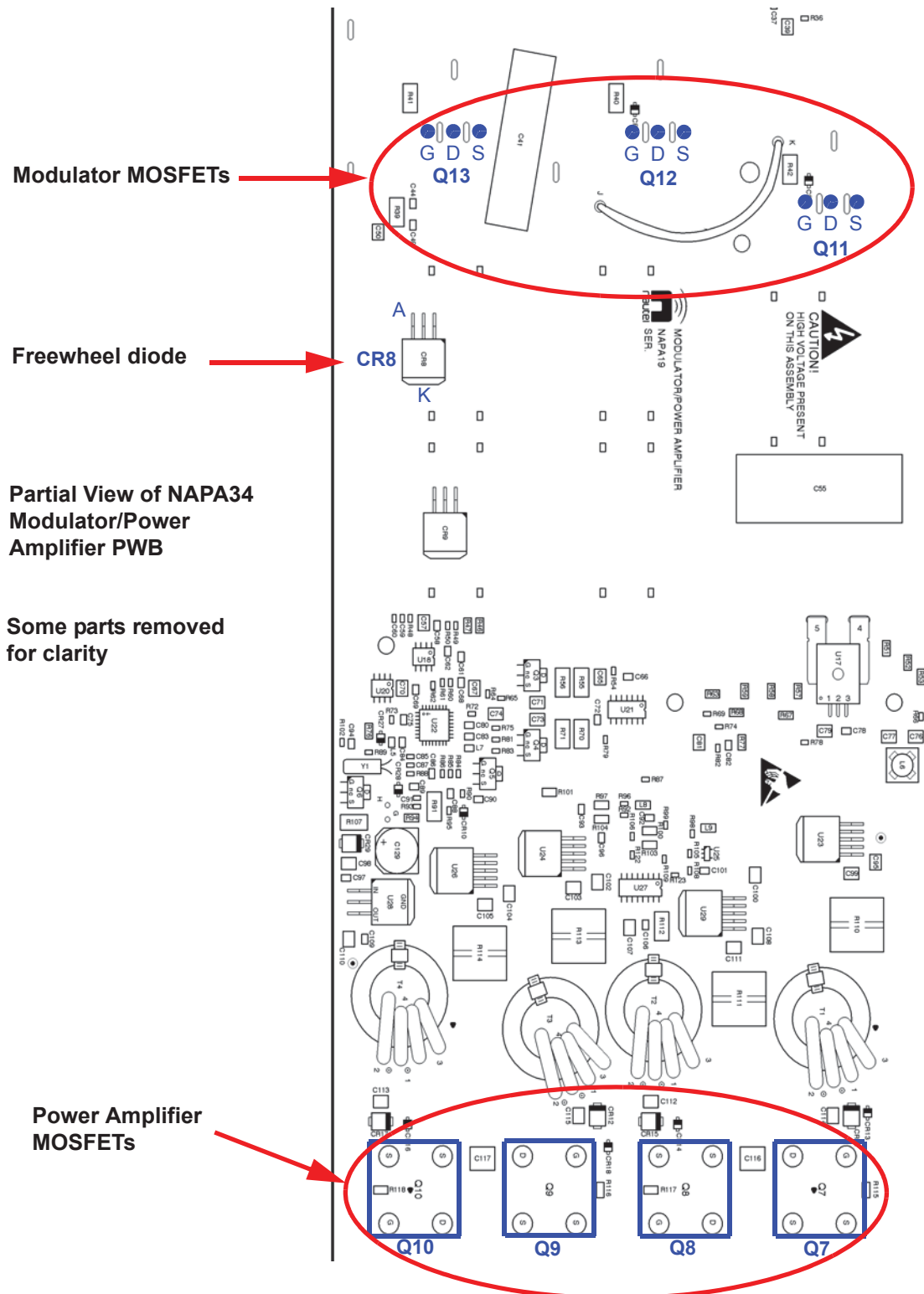

Modulator MOSFETs

Freewheel diode

Partial View of NAPA34  
Modulator/Power  
Amplifier PWB

Some parts removed  
for clarity

Power Amplifier  
MOSFETs

## POWER AMPLIFIER FET REPLACEMENT

See [Figure 1.5 on page 1-33](#).

1. Remove five M3 screws that secure the modulator/power amplifier PWB to the chassis.
2. Remove 16 M4 screws (four for each MOSFET) that secure the PWB to the MOSFETs.
3. Swing the PWB away from the chassis and remove two M4 screws that secure the defective MOSFET to the chassis. If necessary, remove the screw securing the thermistor wire to the PWB.
4. Discard the defective MOSFET and its associated thermal pad (between MOSFET and chassis).
5. Ensure the surface of the chassis/heat sink is clean and free of debris.
6. Obtain a replacement MOSFET (Nautel Part # QR6868) and a new thermal pad (Nautel Part # HAK55) from the spares kit, if purchased, and install them on the RF power module chassis using the two M4 screws removed in step 3. Torque hardware to 12 in-lbs (1.3 N-m).
7. Replace any other defective MOSFETs and then re-install the PWB to the chassis by reversing the instructions in steps 1 through 3. Torque the 16 MOSFET screws (four for each MOSFET) to a maximum of 10 in-lbs (1.1 N-m).
8. Return the power module to service (see [“Installing an RF power module” on page 1-26](#)).



**Figure 1.5: Power Amplifier FET Replacement**

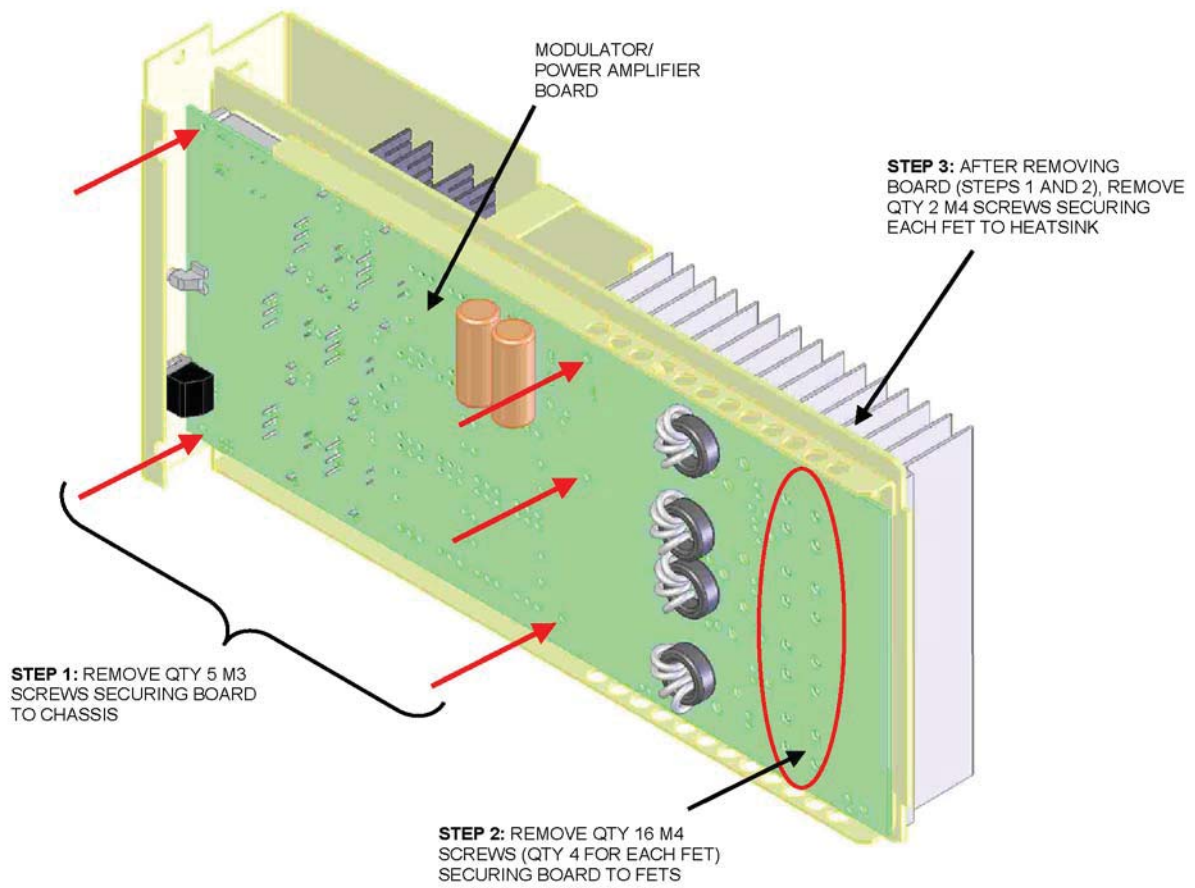

---

## MODULATOR FET REPLACEMENT

1. Remove five M3 screws that secure the modulator/power amplifier PWB to the chassis.
2. Remove 16 M4 screws (four for each MOSFET) that secure the PWB to the MOSFETs.
3. Desolder the gate, drain and source connections that secure the defective MOSFET to the PWB (see [Figure 1.4 on page 1-31](#)). Also desolder the two connections that secure the defective MOSFET's heatsink to the PWB. Remove the heat sink and MOSFET from the PWB.
4. Remove the heatsink clip that holds the MOSFET on its heat sink. Remove and discard the defective MOSFET.

**CAUTION:**

The heat sinks of modulator MOSFETs are coated with a film of thermal compound. Use care to ensure the film does not become contaminated with foreign particles.

When installing a replacement MOSFET, visually inspect the mating surfaces of the MOSFET and its heat sink. Ensure the heat sink surface is coated with a thin film of thermal compound. Ensure foreign particles that may affect thermal transfer are not embedded in the compound.

5. Clean the surface of the heat sink and make sure its is free of debris.
6. Apply a thin film of thermal compound to the heatsink.
7. Obtain a replacement MOSFET (Nautel Part # QR75) from the spares kit, if purchased, and install it on the heat sink using the alignment post on the heat sink as an installation aid. Reinstall the heat sink clip removed in [Step 4](#).
8. Replace any other defective MOSFETs and then re-install the heatsink on the PWB, first by soldering the two heatsink connections and then by soldering the MOSFET's gate, drain and source leads.
9. Reinstall the PWB to the chassis by reversing the instructions in steps 1 and 2. Torque the 16 power amplifier MOSFET screws (four for each MOSFET) to a maximum of 10 in-lbs (1.1 N-m) .
10. Return the power module to service (see [“Installing an RF power module” on page 1-26](#)).

## CONTROL/EXCITER PANEL BOARD REMOVAL/REPLACEMENT

The control/exciter panel (A11, see [Figure 1.6](#)) contains the control/interface PWB (A11A1), two digital AM exciter PWBs [A (A11A2) and B (A11A3)], remote interface PWB (A11A4), optional GPS sync PWB (A11A5) and optional Exgine PWB (A11A7). The control/interface PWB physically interconnects with both digital AM exciter PWBs and the remote interface PWB.

**NOTE:**  
 To remove the control/interface PWB, you must first remove either the remote interface PWB or both digital AM exciter PWBs.

**Figure 1.6: NX100 Control/Exciter Panel**

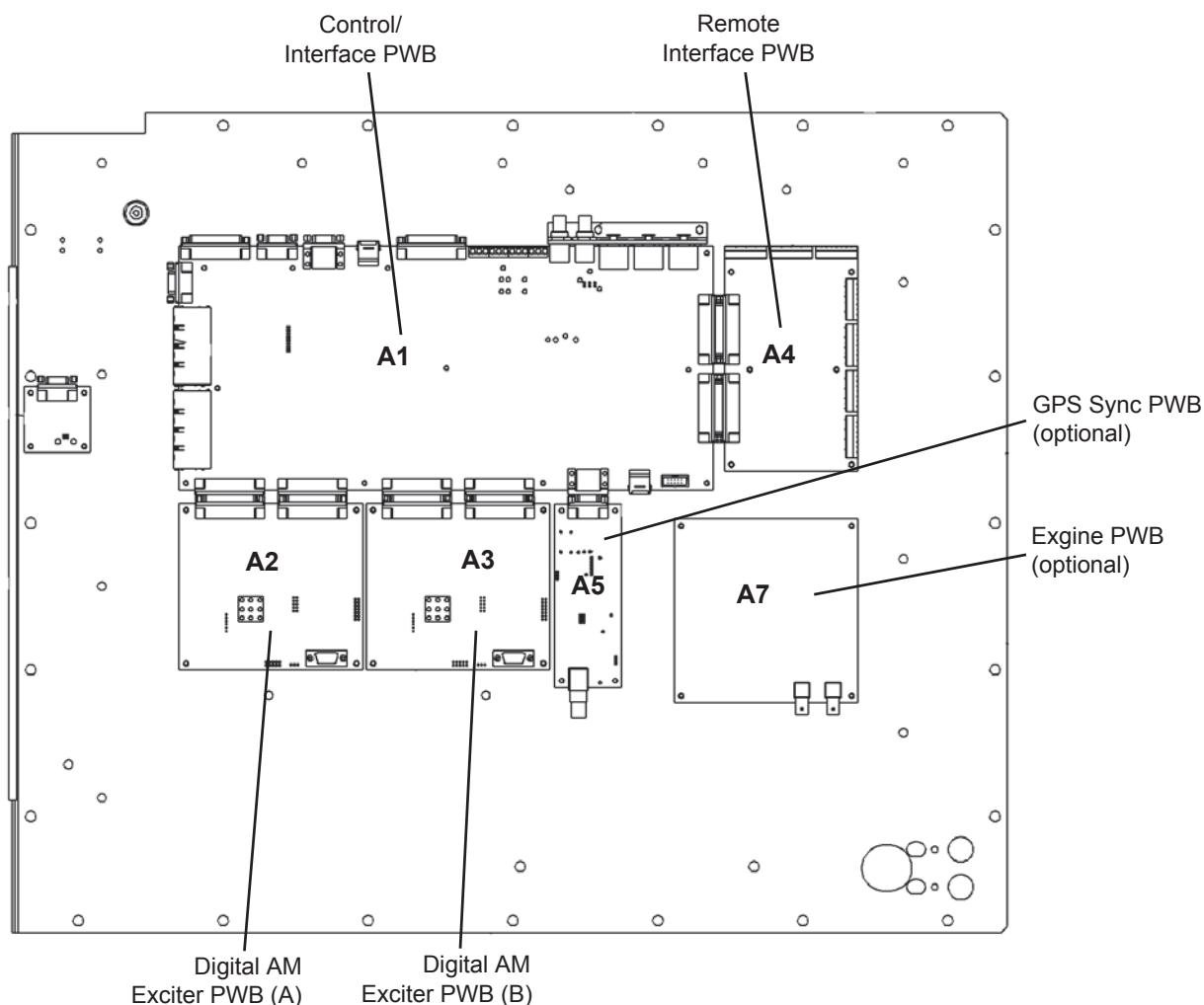

## REMOTE INTERFACE PWB REPLACEMENT

1. Remove and retain six sets of mounting hardware from the remote interface PWB (A11A4).
2. Pull the remote interface PWB away from the control/interface PWB (A11A1). It may be helpful to gently pry the connector loose with a screwdriver.
3. Set the **STATUS/ALARM** jumpers (E1 through E16) on the new remote interface PWB to the same positions as the defective PWB.
4. Use an indelible marker to identify the LED and switch labels on the new remote interface PWB to match the labels on the defective PWB.
5. Install the new remote interface PWB by reversing [Step 1](#) and [Step 2](#).
6. Reconnect all interface wiring to the new remote interface PWB.

## DIGITAL AM EXCITER PWB REPLACEMENT

1. Set the transmitter to its **RF Off** state.
2. Connect a cable between the defective digital AM exciter PWB's RS-232 connector (9-pin D-sub J3, see [Figure 1.7](#) on page 1-36) and a PC.

**Figure 1.7: Part of Digital AM Exciter PWB - Location of RS-232 Connector J3**

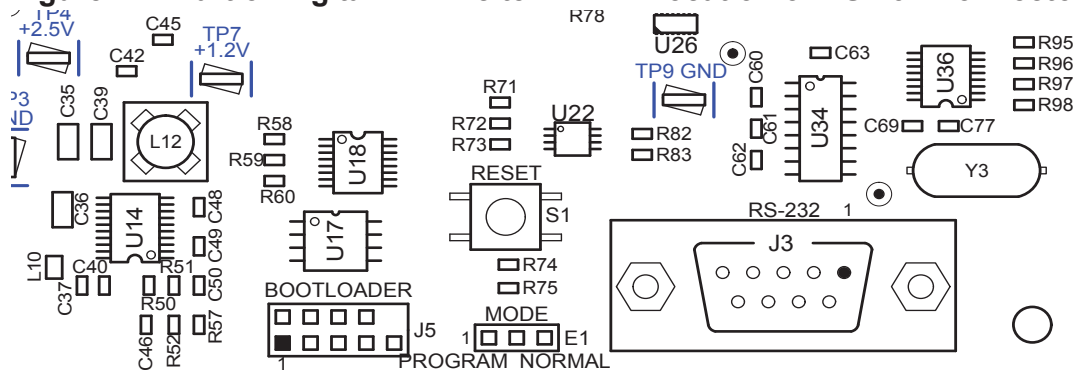

3. On **MODE** program header E1 (see [Figure 1.7](#)), install the shorting jumper in the **PROGRAM** position (shorting pins 1 and 2). Press **RESET** switch S1, located directly above E1.
4. From the PC, run the NCode Uploader application (see [Figure 1.8](#)). Click **Settings** and ensure the COM port reflects the port that the serial cable is connected to on your PC.

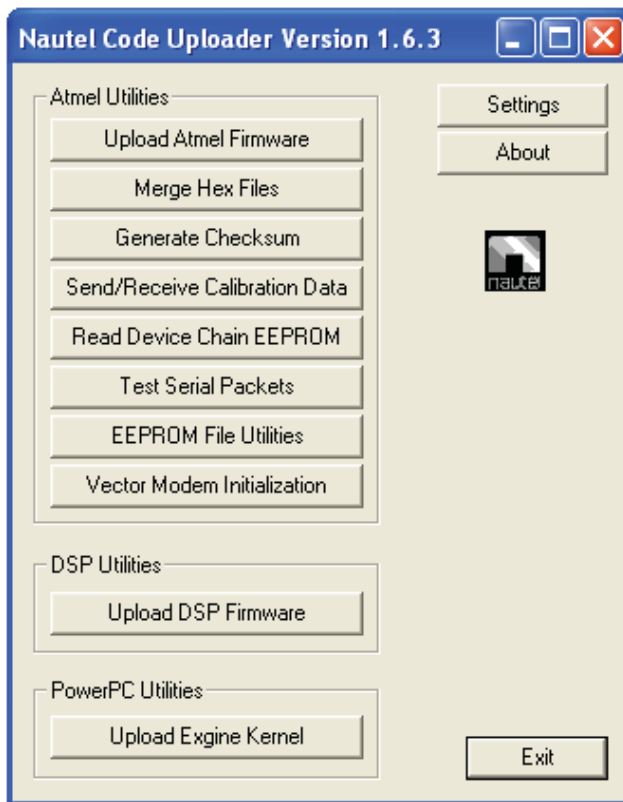
**Figure 1.8: NCode Uploader Menu**

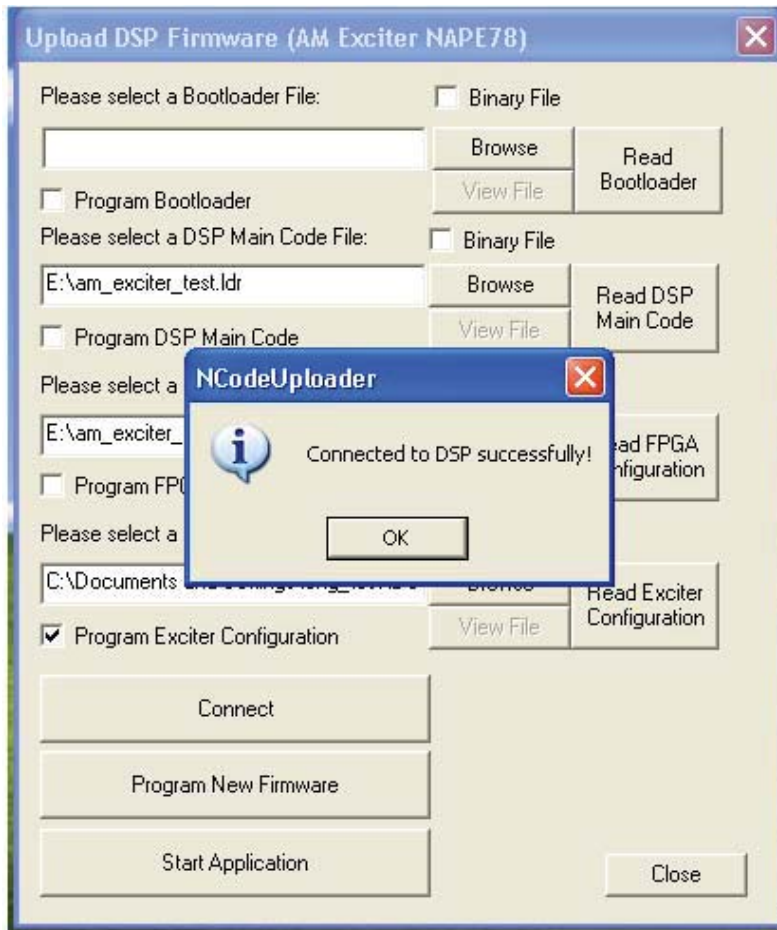
**Figure 1.9: Upload DSP Firmware Menu**

5. Click the **Upload DSP Firmware** button (see [Figure 1.8 on page 1-37](#)). The menu shown in [Figure 1.9](#) should appear, along with the **Connected to DSP successfully!** prompt. Click **OK**.
6. Once connected, click the **Read Exciter Configuration** button. Select **Save file to disk** and click **OK** (see [Figure 1.10 on page 1-39](#)) to save the current calibration data. Browse to a desired location to save the file.
7. If the defective exciter does not allow the previous steps to be performed, try using the operational exciter to save the required calibration data. In this case, repeat [Step 2](#) through [Step 6](#) for the operational exciter's digital AM exciter PWB. If there is no operational exciter, contact Nautel for the required calibration data.

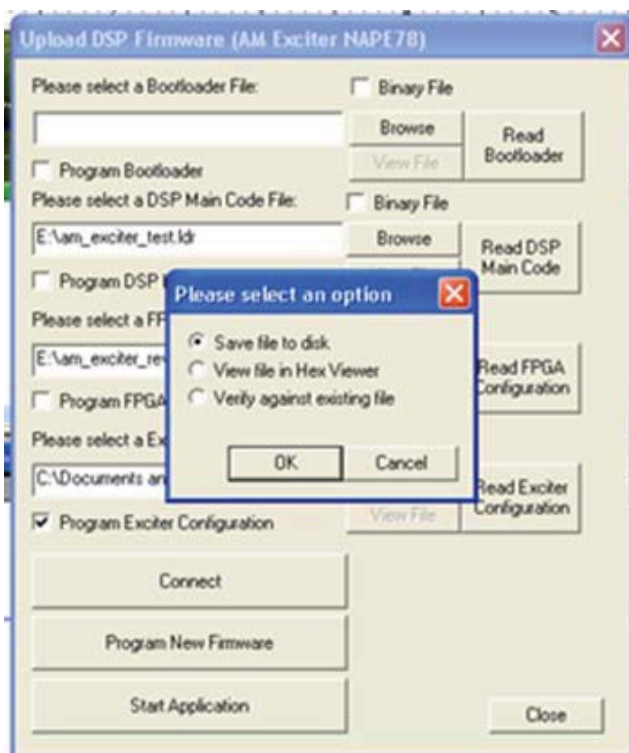
**Figure 1.10: Upload DSP Firmware Menu - Select an Option**

8. Remove and retain four sets of mounting hardware from the digital AM exciter PWB being replaced (A11A1 or A11A2).
9. Pull the digital AM exciter PWB away from the control/interface PWB (A11A1). It may be helpful to gently pry the connector loose with a screwdriver.
10. Install the new digital AM exciter PWB by reversing [Step 8](#) and [Step 9](#).
11. Connect a cable between the replacement digital AM exciter PWB's RS-232 connector (9-pin D-sub J3, see [Figure 1.7 on page 1-36](#)) and a PC.
12. On the digital AM exciter PWB's **MODE** program header E1 (see [Figure 1.7](#)), install the shorting jumper in the **PROGRAM** position (shorting pins 1 and 2). Press **RESET** switch S1, located directly above E1.
13. Once connected, use the PC to browse to the configuration file saved in [Step 6](#) by clicking the **Browse** button next to the "Please Select a Exciter Configuration file:" field (see [Figure 1.11 on page 1-40](#)).

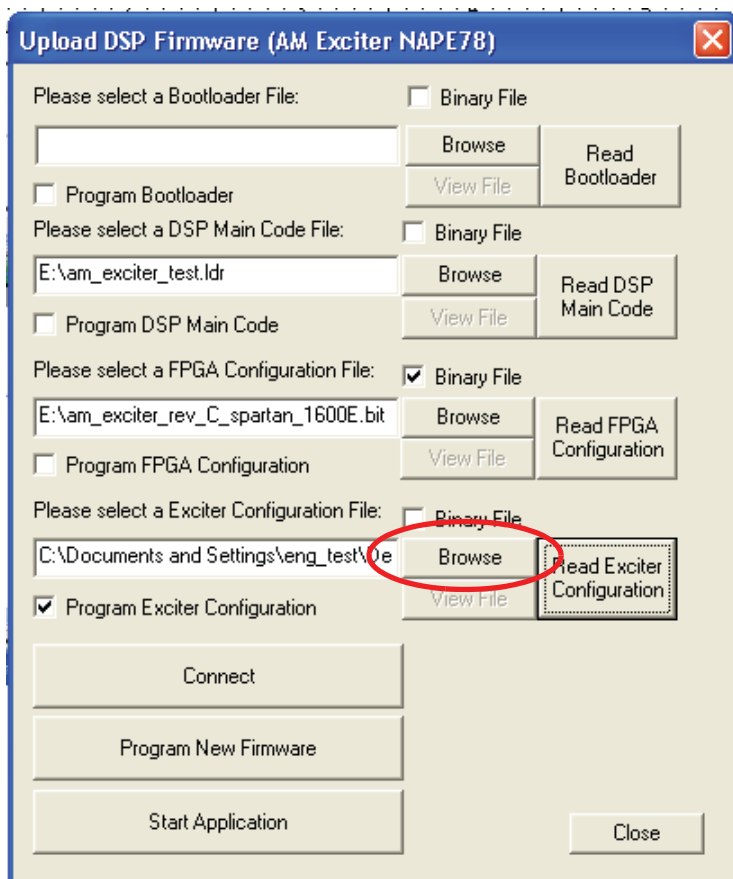
**Figure 1.11: Upload DSP Firmware Menu - Browse for configuration file**

14. Click the **Program Exciter Configuration** checkbox (see [Figure 1.11 on page 1-40](#)) so that the box contains a checkmark and then click the **Program New Firmware** button.
15. On the digital AM exciter PWB's **MODE** program header E1 (see [Figure 1.7](#)), return the shorting jumper to the **NORMAL** position (shorting pins 2 and 3). Press **RESET** switch S1, located directly above E1.
16. On the front panel AUI, reset any active alarms.
17. Upgrade the subsystem software using the AUI's **Upgrade Software** page under the **System Settings** menu. See the *NX100 Operations and Maintenance Manual* for detailed instructions.
18. Set the transmitter to its **RF On** state.



---

## CONTROL/INTERFACE PWB REPLACEMENT

1. Record the following information (as a minimum) from the front panel AUI:
  - **Presets** page: record settings for all desired presets
  - **Scheduler** page: record **Rules** and **Daily Events** information
  - **Factory Settings** page: record information in the **RF Symmetry** and **Transmitter Type** menus
  - **System Settings** page: record all information in the **Exciter Clock Calibration** and **Power Lockout** menus
  - **User Settings** page: record all information in the **Network Setup** menu
  - **Remote I/O** page: record all information for the user-defined remote **Inputs** and **Outputs**, including **Channel** and **Control** settings
  - **Changeover** page: record all information
2. Use a digital multimeter to measure the VSWR threshold voltage on the control/interface PWB at R73-LHS. Record this voltage.
3. Set the transmitter to its **RF Off** state. Turn off (disable or lock out) the ac power at the source. Open the front door to gain access to the exciter panel (see [Figure 1.6 on page 1-35](#)).
4. Disconnect all cables attached to the control/interface PWB (A4), taking note of the connector labels on the cables and the PWB.
5. Remove and retain the two screws securing the connector bracket in the upper, left portion of the control/interface PWB.
6. Remove either the remote interface PWB (A11A4) or both digital AM exciter PWBs (A11A2 and A11A3), whichever is easier. It may be helpful to gently pry the connectors loose with a screwdriver.
7. Remove and retain 13 sets of mounting hardware from the control/interface PWB (A11A1).
8. Obtain a replacement control/interface PWB (Nautel Part # NAPC160B/01).
9. Set the **COMB CONT INTLK** (E1) and **REMOTE SUPPLY** (E3) jumpers on the replacement PWB to the same positions as the defective PWB.
10. Install the new control/interface PWB by reversing [Step 4](#) through [Step 7](#). For connector mating assistance, refer to the connector mating tables in [Section 4, “Wiring/connector lists” on page 4-1](#).

11. Re-enter all the AUI information recorded in [Step 1](#).
12. Set the time using the front panel AUI's **Factory Settings - Time Setup** page.
13. Measure the VSWR threshold voltage on the control/interface PWB at R73-LHS. Adjust **VSWR THRESHOLD** potentiometer R78 until the multimeter reading is the same as the voltage recorded in [Step 2](#).
14. Upgrade the subsystem software using the AUI's **Upgrade Software** page under the **System Settings** menu. See the *NX100 Operations and Maintenance Manual* for detailed instructions.

## GPS SYNC PWB REPLACEMENT

1. Remove and retain four sets of mounting hardware from the GPS sync PWB being replaced (A11A5).
2. Set the jumpers on the replacement PWB to the same positions as the defective PWB.
3. Install the new GPS sync PWB by reversing [Step 1](#) and [Step 2](#).

**NOTE:**

*Remove the jack screws from 9-pin D-sub connector J1 on the new GPS sync PWB before installing it.*

## ENGINE PWB REPLACEMENT

1. Remove and retain four sets of mounting hardware from the engine PWB (A11A7).
2. Set the jumpers on the replacement PWB to the same positions as the defective PWB.
3. Install the new engine PWB by reversing [Step 1](#) and [Step 2](#).

---

## PDM DRIVE DISTRIBUTION PWB REPLACEMENT

**WARNING:**

LETHAL VOLTAGES EXIST INSIDE THE TRANSMITTER WHEN THE POWER IS TURNED ON. TURN OFF THE POWER AT THE SOURCE AND VERIFY THE 2040 BRIGHT GREEN LEDs ON THE POWER MODULE INTERFACE PWBs - IN THE BACK OF EACH CABINET - ARE OFF BEFORE REMOVING ANY CONNECTIONS OR PWBs.

See [Figure 1.12](#).

**Figure 1.12: Location of PDM Drive Distribution PWB**

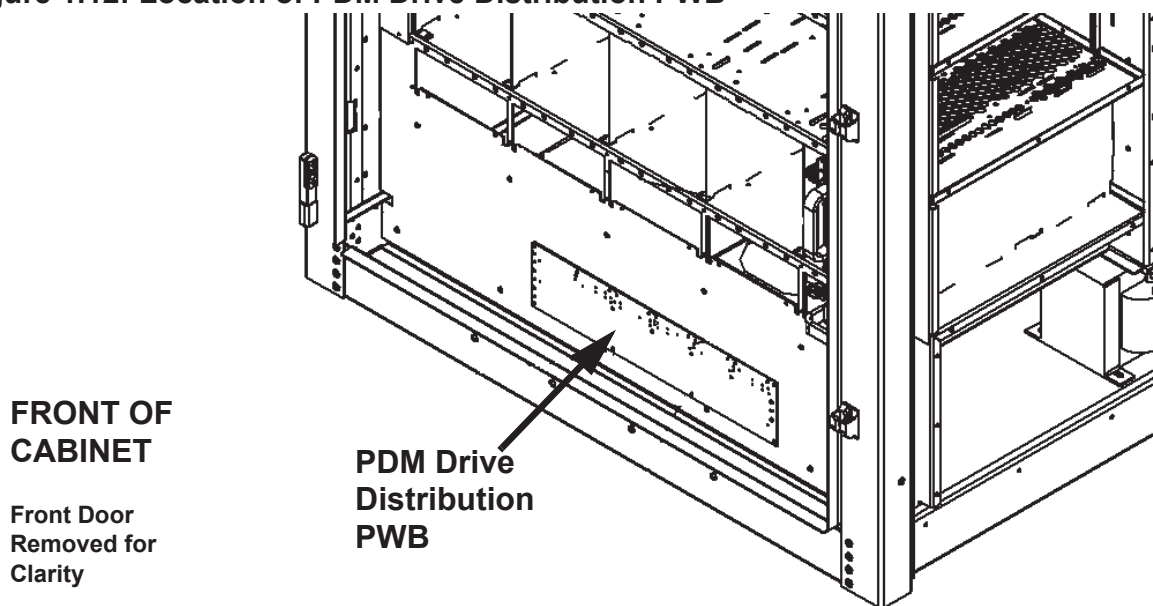

1. Open the front door.
2. Disconnect all cables attached to the PDM drive distribution PWB, taking note of the connector labels on the cables and the PWB.
3. Remove and save six sets of mounting hardware.
4. Remove the defective PWB from the transmitter.
5. Reverse [Step 1](#) through [Step 4](#) to install the new PWB.

---

## RF DRIVE DISTRIBUTION PWB REPLACEMENT

**WARNING:**

LETHAL VOLTAGES EXIST INSIDE THE TRANSMITTER WHEN THE POWER IS TURNED ON. TURN OFF THE POWER AT THE SOURCE AND WAIT UNTIL THE 2040 BRIGHT GREEN LEDs ON THE POWER MODULE INTERFACE PWBs - IN THE BACK OF EACH CABINET - ARE OFF BEFORE REMOVING ANY CONNECTIONS OR PWBs.

See [Figure 1.13](#).

**Figure 1.13: Location of RF Drive Distribution and Rack Interface PWBs**

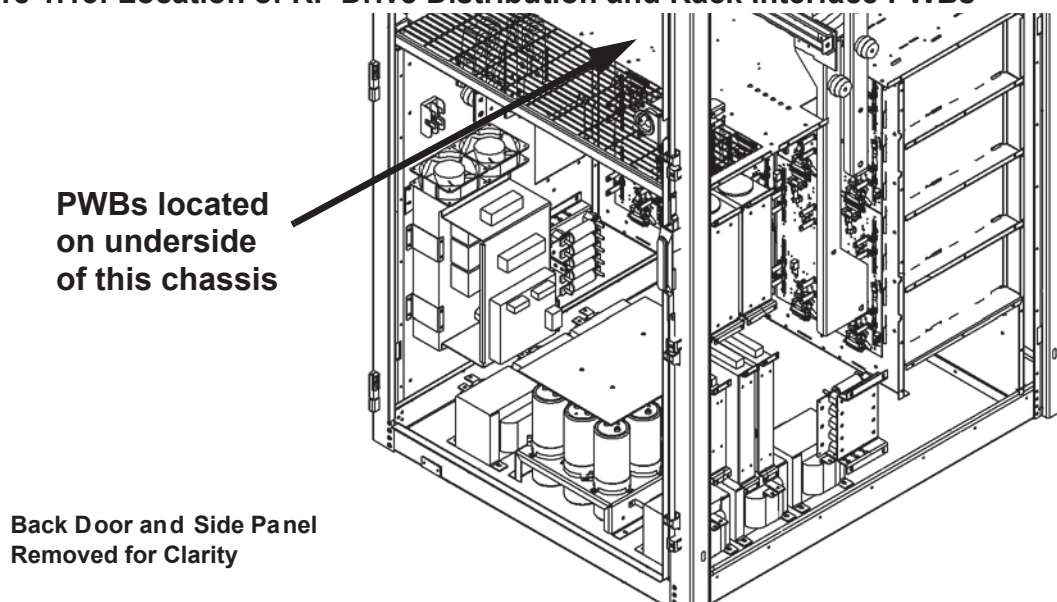

1. Turn off the ac power at the source. Open the back door and verify the green LEDs on the power module interface PWBs are off, indicating the capacitors are discharged. For additional safety, measure the dc voltage across the + and - terminals of any of the large, electrolytic capacitors on the floor of the cabinet. There should be little or no voltage.
2. Disconnect all cables attached to the RF drive distribution PWB, taking note of the connector labels on the cables and the PWB.
3. Carefully remove and save seven sets of mounting hardware.
4. Remove the PWB from the transmitter.
5. Reverse [Step 1](#) through [Step 4](#) to reinstall the PWB.

## RACK INTERFACE PWB REPLACEMENT



**WARNING:**

LETHAL VOLTAGES EXIST INSIDE THE TRANSMITTER WHEN THE POWER IS TURNED ON. TURN OFF THE POWER AT THE SOURCE AND WAIT UNTIL THE 2040 BRIGHT GREEN LEDs ON THE POWER MODULE INTERFACE PWBs - IN THE BACK OF EACH CABINET - ARE OFF BEFORE REMOVING ANY CONNECTIONS OR PWBs.

See [Figure 1.13 on page 1-44](#).

1. Turn off the ac power at the source. Open the back door and verify the green LEDs on the power module interface PWBs are off, indicating the capacitors are discharged. For additional safety, measure the dc voltage across the + and - terminals of any of the large, electrolytic capacitors on the floor of the cabinet. There should be little or no voltage.
2. Remove the interconnecting RF drive distribution PWB (see [“RF drive distribution PWB replacement” on page 1-44](#)). Gently pry the connectors loose with a screwdriver.
3. Disconnect all cables attached to the rack interface PWB, taking note of the connector labels on the cables and the PWB.
4. Carefully remove and retain six sets of mounting hardware.
5. Remove the rack interface PWB from the transmitter.
6. Obtain a replacement rack interface PWB (Nautel Part # NAPI152A) and set DIP switch S1 as follows.

S1 Position	A15 Setting
8	CLOSED
7	CLOSED
6	OPEN
5	CLOSED
4	CLOSED
3	CLOSED
2	OPEN
1	OPEN

S1 Position	A6 Setting
8	CLOSED
7	CLOSED
6	OPEN
5	CLOSED
4	CLOSED
3	CLOSED
2	OPEN
1	OPEN

- Reverse [Step 1](#) through [Step 5](#) to reinstall the PWB.
- If you are replacing the Controller's rack interface PWB, disengage all RF power modules in the transmitter before turning on the ac power (see "[Removing and reinstalling RF power modules](#)" on page 1-24).
- One at a time, reinstall each RF power module. The LED sequence on the front panel of each module should change to solid red. Reconnect each RF power module's PDM cable; the LED sequence should change to flashing amber.
- Upgrade the subsystem software using the AUI's [Upgrade Software](#) page under the **System Settings** menu. See the *NX100 Operations and Maintenance Manual* for detailed instructions.

---

## SCR RECTIFIER INSPECTION/REPLACEMENT

**WARNING:**

LETHAL VOLTAGES EXIST INSIDE THE TRANSMITTER WHEN THE POWER IS TURNED ON. TURN OFF THE POWER AT THE SOURCE AND WAIT UNTIL THE 2040 BRIGHT GREEN LEDs ON THE POWER MODULE INTERFACE PWBS - IN THE BACK OF EACH CABINET - ARE OFF BEFORE REMOVING ANY CONNECTIONS OR ASSEMBLIES.

See Figure 1.14.

**Figure 1.14: Location of SCR Rectifier Assembly U1 and its Cooling Fans**

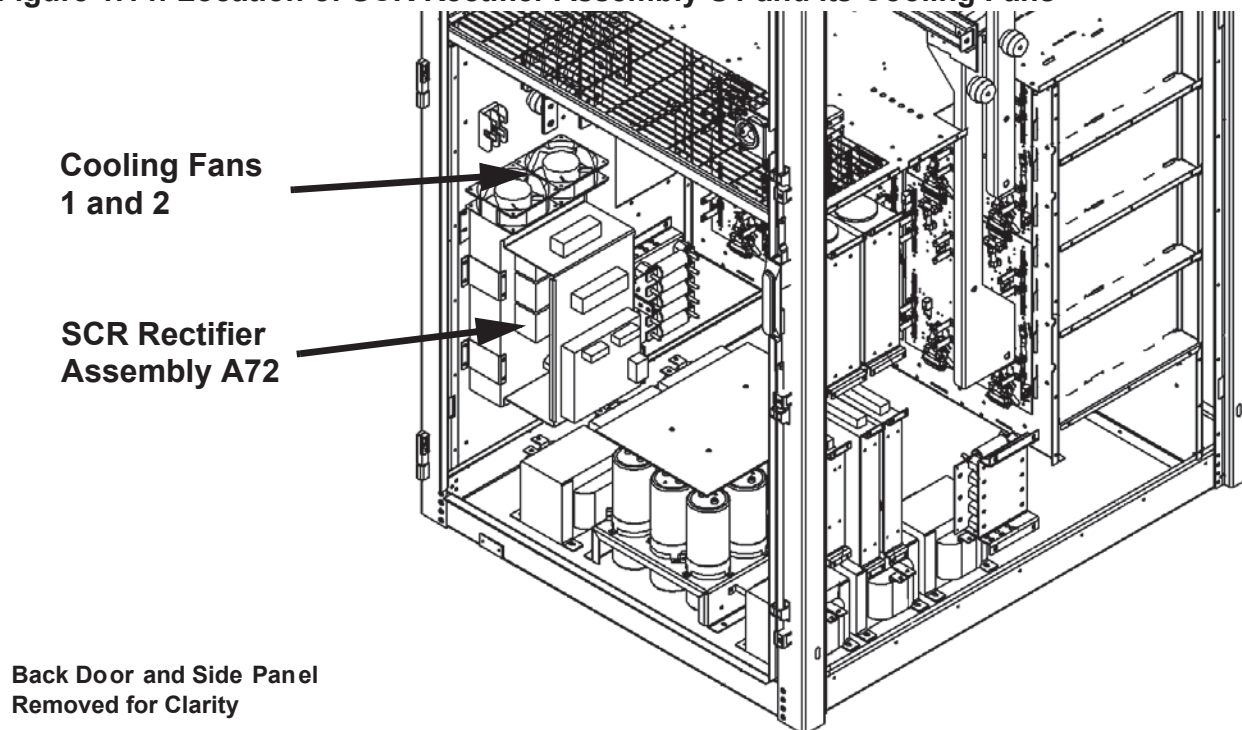

1. Turn off the ac power at the source. Open the back door and verify the green LEDs on the power module interface PWBs are off, indicating the capacitors are discharged. For additional safety, measure the dc voltage across the + and - terminals of any of the large, electrolytic capacitors on the floor of the cabinet. There should be little or no voltage.

2. If you are responding to a **Rectifier Fan 1 (or 2) Fail** alarm (if not, proceed to [Step 3](#)), inspect the SCR rectifier assembly's cooling fans (see [Figure 1.14 on page 1-47](#)) for debris that might restrict proper movement of the fan blades. If there is no noticeable debris, remove the suspect fan (1 or 2, as specified by the alarm) by disconnecting its wiring and then removing the four Philips screws securing it to the top of A72. Replace the fan with a suitable replacement (48 V muffin fan, EBM Part # W1G110-AG07-05). Secure the replacement fan to the SCR rectifier assembly and connect the fan's wiring as it was previously installed. Return the transmitter to service.
3. Disconnect all wiring attached to the SCR rectifier assembly, taking note of the wiring labels.
4. While supporting the weight of the SCR rectifier assembly, remove and save 12 sets of mounting hardware.
5. Remove the SCR rectifier assembly from the transmitter.
6. Reverse [Step 1](#) through [Step 4](#) to reinstall the new or repaired SCR rectifier assembly. Ensure all connections are tight, noting some connections have special torque requirements (e.g., torque the 2 AWG wires connecting to LINE 1, LINE 2 and LINE 3 to 12 N-m (106 in-lbs). For wiring termination assistance with connections to the SCR rectifier assembly (A72), check the wiring list in [Section 4, "Wiring/connector lists" on page 4-1](#).



---

## LOW VOLTAGE POWER SUPPLY REPLACEMENT

**WARNING:**

LETHAL VOLTAGES EXIST INSIDE THE TRANSMITTER WHEN THE POWER IS TURNED ON. TURN OFF THE POWER AT THE SOURCE AND WAIT UNTIL THE 2040 BRIGHT GREEN LEDs ON THE POWER MODULE INTERFACE PWBS - IN THE BACK OF EACH CABINET - ARE OFF BEFORE REMOVING ANY CONNECTIONS OR ASSEMBLIES.

See Figure 1.15 on page 1-49.

1. Turn off the ac power at the source. Open the back door and verify the green LEDs on the power module interface PWBs are off, indicating the capacitors are discharged. For additional safety, measure the dc voltage across the + and - terminals of any of the large, electrolytic capacitors on the floor of the cabinet. There should be little or no voltage.
2. Disconnect all wiring attached to the affected power supply module (U3 through U7), taking note of the connector labels on the cables.

**Figure 1.15: Location of Low Voltage Power Supplies U3 through U7**

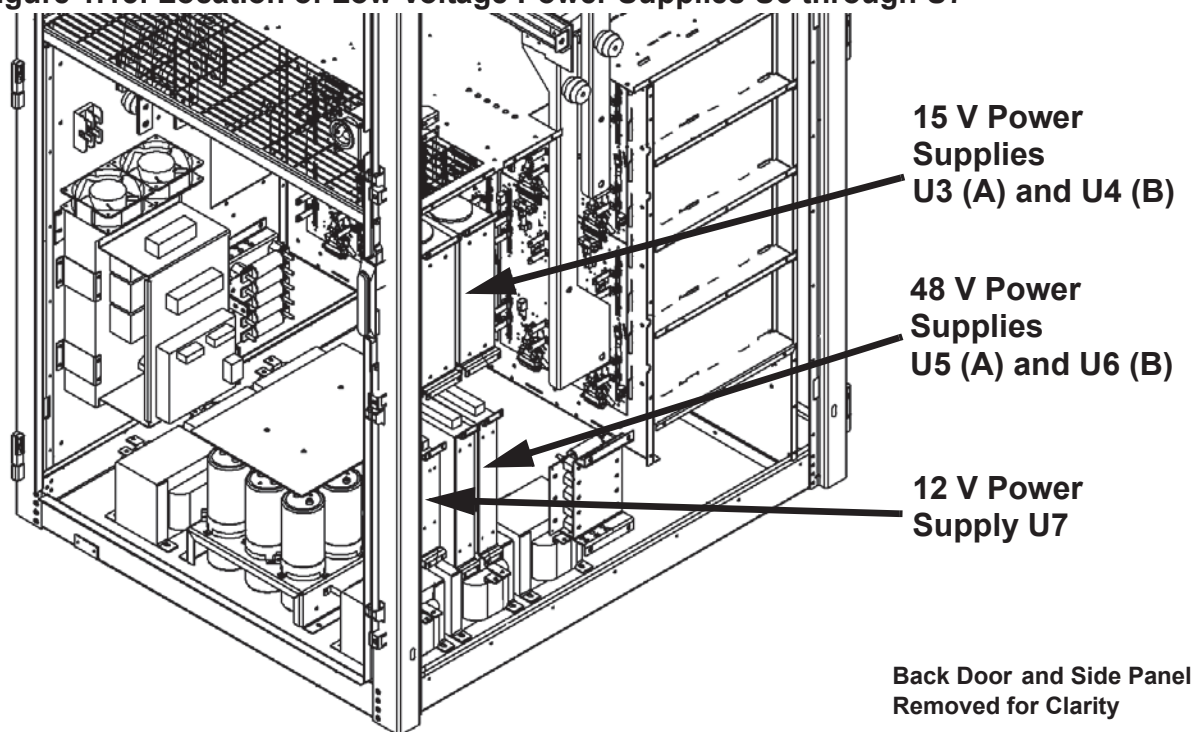

3. Remove and save four sets of mounting hardware.

4. Remove the power supply module from the transmitter, noting its reference designation (U3 through U7) should be marked on the side panel near the module.
5. Reverse [Step 1](#) through [Step 4](#) to reinstall the new power supply module. Reconnect all wiring.

## RF POWER MODULE FAN TRAY REPLACEMENT

See Figure 1.16.

**Figure 1.16: Location of Fan Tray Assemblies**

Fan Tray	Associated RF Power Module #s (A15-A34)
A35	A15,A16,A25,A26
A36	A17,A18,A27,A28
A37	A19,A20,A29,A30
A38	A21,A22,A31,A32
A39	A23,A24,A33,A34

Fan Tray Assemblies

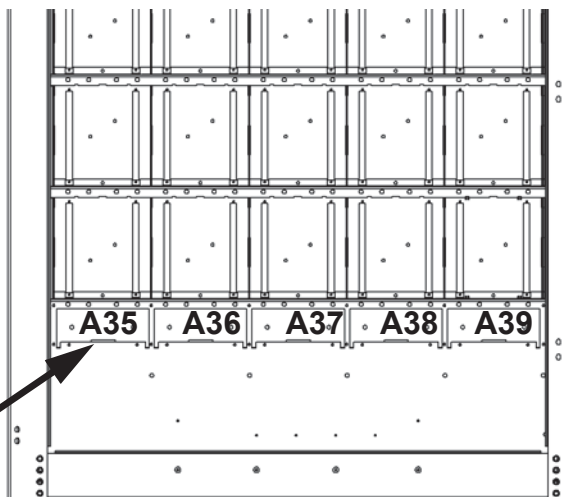

Front Door Removed for Clarity

Fan Tray	Associated RF Power Module #s (A20-A59)
A60	A20,A21,A30,A31,A40,A41,A50,A51
A61	A22,A23,A32,A33,A42,A43,A52,A53
A62	A24,A25,A34,A35,A44,A45,A54,A55
A63	A26,A27,A36,A37,A46,A47,A56,A57
A64	A28,A29,A38,A39,A48,A49,A58,A59

Fan Tray Assemblies

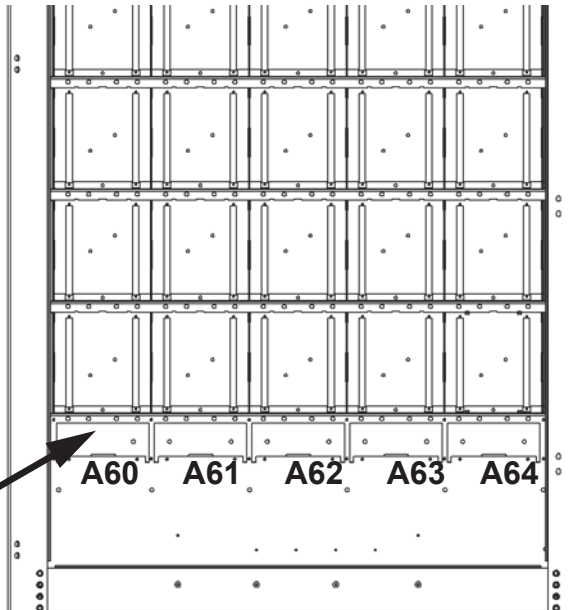

Front Door Removed for Clarity

1. Open the front door.
2. Determine the suspect fan tray assembly (A35A60 through A39A64) associated with the offending RF power module # alarm(s).
3. Remove and save two sets of mounting hardware. Pull the fan tray assembly out of the transmitter.
4. Reverse [Step 1](#) through [Step 3](#) to install the new fan tray assembly.