

# NX50 TRANSMITTER

## OPERATIONS AND MAINTENANCE MANUAL

Document: NHB-NX50-OPS

Issue: 3.0 2012-11-01

Status: Standard





**Nautel Limited**

10089 Peggy's Cove Road  
Hackett's Cove, NS Canada B3Z 3J4  
Phone: +1.902.823.3900 or  
Toll Free: +1.877.6NAUTEL (6628835) (Canada & USA only)  
Fax: +1.902.823.3183

**Nautel Inc.**

201 Target Industrial Circle  
Bangor, Maine USA 04401  
Phone: +1.207.947.8200  
Fax: +1.207.947.3693

**Customer Service (24 hour support)**

+1.877.628.8353 (Canada & USA only)  
+1.902.823.5100 (International)

Email: [support@nautel.com](mailto:support@nautel.com)

Web: [www.nautel.com](http://www.nautel.com)

The comparisons and other information provided in this document have been prepared in good faith based on publicly available information. The reader is encouraged to consult the respective manufacturer's most recent published data for verification.

© Copyright 2012 NAUTEL. All rights reserved.



---

# CONTENTS

---

<b>RELEASE CONTROL RECORD</b>	<b>VII</b>
-------------------------------	------------

---

<b>DESCRIPTION</b>	<b>1-1</b>
--------------------	------------

Ac-dc power stage	1-1
-------------------	-----

Exciter stage	1-2
---------------	-----

Control/monitor stage	1-4
-----------------------	-----

RF power stage	1-5
----------------	-----

RF output network	1-5
-------------------	-----

---

<b>OPERATING THE TRANSMITTER</b>	<b>2-1</b>
----------------------------------	------------

Using the AUI	2-2
---------------	-----

Home page - describing the first page	2-17
---------------------------------------	------

Menu page - describing transmitter operations	2-18
---	------

Viewing Transmitter Log	2-20
-------------------------	------

Instrument Panels - viewing displays	2-27
--------------------------------------	------

Meters page - viewing real-time meters	2-42
--	------

Presets - editing operational settings	2-48
--	------

Preset Scheduler	2-61
------------------	------

Status - viewing transmitter status	2-64
-------------------------------------	------

User Accounts	2-66
---------------	------

User Settings	2-71
---------------	------

System Settings page	2-89
----------------------	------

Precorrection Settings page	2-97
-----------------------------	------

Changeover page - changing exciter transfer settings	2-106
--	-------

Factory Settings	2-107
------------------	-------

Remote I/O page	2-116
-----------------	-------

Playlist Manager	2-121
------------------	-------

Using the safety interlock switch	2-126
-----------------------------------	-------

---

---

<b>ROUTINE MAINTENANCE</b>	<b>3-1</b>
Scheduled maintenance	3-1
Replacing a damaged air filter	3-2
Performing on-air checks	3-3
Replacing the control/interface PWB battery	3-4
Inspecting lightning protection systems	3-5

---

<b>NON-STANDARD MAINTENANCE</b>	<b>4-1</b>
Upgrading software	4-1

---

<b>LIST OF TERMS</b>	<b>5-1</b>
----------------------	------------

## RELEASE CONTROL RECORD

Issue	Date	Reason
3.0	2012-11-01	Release 3 of transmitter (NARA53B) Software Release NX4.0





## SECTION 1: DESCRIPTION

Refer to the functional block diagram: [Figure 1.6 on page 1-11](#).

This section provides a high-level description of the transmitter's key sections. The transmitter circuitry is subdivided into five basic stages.

- [Ac-dc power stage](#)
- [Exciter stage - see page 1-2](#)
- [Control/monitor stage - see page 1-4](#)
- [RF power stage - see page 1-5](#)
- [RF output network - see page 1-5](#) (includes combiner and filter)

### NX50 ELECTRICAL SCHEMATICS

Some descriptions in this section refer to electrical schematics (SD-#s) . These are located at the end of the *NX50 Troubleshooting Manual*.

### REDUNDANCY

The NX50 features redundancy in all key systems:

- RF power modules
- Exciters
- Cooling fans

---

### AC-DC POWER STAGE

See electrical schematic **SD-1**. The ac/dc power supply stage contains the input power transformer that receives the main ac input to the transmitter. It also contains the transmitter's low voltage power supplies and rack interface PWB. The ac/dc power supply stage also include a three-phase SCR rectifier assembly, Hall Effect current sensor, and B+ distribution assemblies. With the exception of the power transformer, which has its own cabinet, each cabinet in the transmitter system contains its own ac/dc power stage components.

---

The secondary of the power transformer is applied to the SCR rectifier assembly to create the transmitter's B+ voltage. The output of the rectifier assembly is fed through the Hall Effect current sensor, which supplies a dc current signal to the rack interface PWB. The rectifier assembly output is applied to the B+ distribution assemblies, which then provide the B+ voltage to the RF power modules, and a B+ sample to the rack interface PWB.

One phase of the power transformer's secondary is also used to provide a source for the low voltage dc power supplies and an ac sample for the rack interface PWB. The low voltage power supply outputs (+48 V, +15 V and +12 V) are distributed throughout the transmitter via the rack interface PWB.

## AC POWER TRANSFORMER

The NX50's power transformer can be set to use a range of input voltages. See [Section 4](#), "Connecting transformer taps/load wiring" on page 4-1 in the *NX50 Installation Manual*.

---

## EXCITER STAGE

See electrical schematic [SD-2](#) and [Figure 1.1 on page 1-3](#). The exciter stage consists of digital AM exciter PWBs A (A11A2) and B (A11A3), RF drive distribution PWB (A16), and PDM distribution PWB (A17). The dual digital AM exciter PWBs provide two independent exciter sections (A and B), which can be selected automatically or by local or remote control. The control/interface PWB acts as an interface point for audio inputs and RF drive and PDM outputs.

## DIGITAL AM EXCITER PWBs

Digital AM exciter PWBs A (A11A2) and B (A11A3) accept audio or IBOC inputs from an integrated DRM exciter or Exgine card and generate fully digital RF drive carrier frequency sources and interphase PDM drive signals for the power amplifiers and modulators in the RF power modules.

Audio input can be applied as as analog (balanced or AES-EBU) or digital (I/Q in AES/EBU or CMOS format). All audio inputs are digitized, as necessary, and sample rate converted. A DSP provides initial data conditioning, including the initial filtering and interpolation of incoming audio or digital radio data.

An FPGA generates the digital PDM signals and synthesizes the carrier frequency RF drive signal. It also performs digital up-conversion, reverse path demodulation and downconversion and B+ voltage compensation.

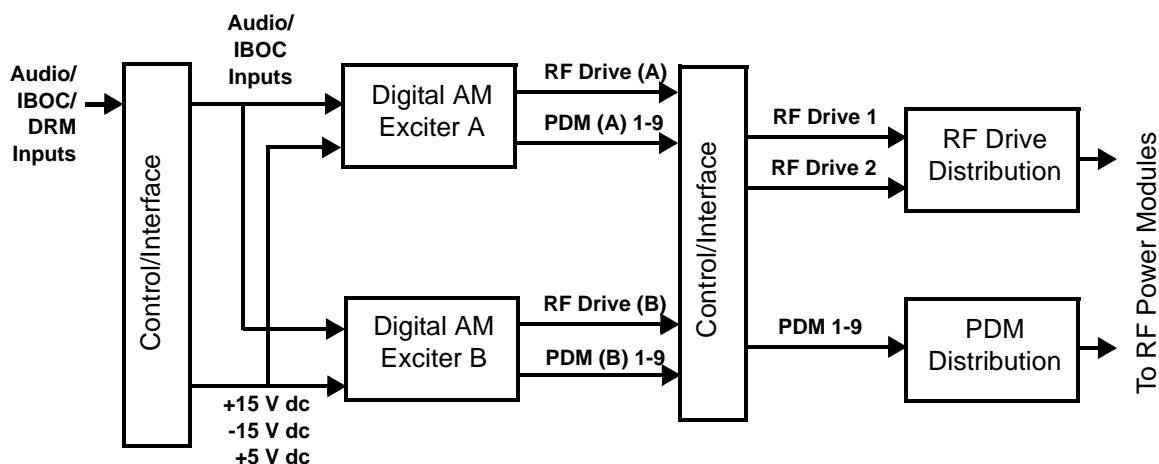
**Figure 1.1: Exciter Stage**

The digital PDM component consists of nine phased PDM signals, each separated by 40 electrical degrees. These PDM drive signals determine the transmitter output power level as well as the output modulation level. Three of these phases, each separated by 120 electrical degrees (e.g., 1, 4 and 7), are applied to a given RF power module. To achieve optimal harmonic cancellation, three different phases (e.g., 2, 5 and 8) are applied to the adjacent module, and three other phases (e.g., 3, 6 and 9) are applied to the next module.

Samples of the RF output voltage, RF output current and RF power module temperature are monitored. If a parameter exceeds an acceptable limit, the active exciter attempts to compensate by decreasing its output power to restore the parameter to an acceptable level.

A sample of the B+ supply voltage is monitored. A B+ compensation circuit attempts to regulate the regulated B+ supply in order to hold the transmitter output power constant and minimize distortion.

An inhibit PDM input is applied from the control/display PWB to inhibit the PDM drive during certain alarm/fault conditions.

## RF DRIVE DISTRIBUTION

The control/interface PWB (A11A1) accepts the RF drive (+ and -) signals from the digital AM exciter PWBs (A and B) and splits the active exciter's RF drive signal for application to the RF drive distribution PWB (A16). The RF drive distribution PWB splits the signal from the control/interface PWB and buffers the individual outputs that are provided to the RF power stage.

---

## PDM DISTRIBUTION

The control/interface PWB (A11A1) accepts the PDM (1 through 9) signals from the digital AM exciter PWBs (A and B) and splits the active exciter PDM signals for application to the PDM distribution PWB (A17). The PDM distribution PWB accepts each signal from the control/interface PWB and splits it into two (+ and -) opposite logic outputs that are provided to the RF power stage.

---

## CONTROL/MONITOR STAGE

See electrical schematic [SD-3](#) and [Figure 1.2 on page 1-4](#).

The control/monitor stage monitors critical signal samples and status/alarm signals from the exciter stage, RF power stage, and ac/dc power stage. For example, RF power monitoring and RF power stage status information is applied to the control/monitor stage. Based on the value and status of each input, the control/monitor stage produces the appropriate control signals for the exciter stage and the RF power stage to ensure the proper operation and protection of the transmitter.

All analog and digital program inputs are applied to the transmitter via the control/interface PWB for distribution to the exciter stage.

A 17-inch, colour LCD screen mounted on the front of the control cabinet provides an advanced user interface (AUI) for the transmitter. The AUI can be controlled by touch screen and is also available as a flash graphic on any web-interfaced PC or handheld device via the internal NX web server. See [“Advanced user interface” on page 2-2](#) for detailed information on AUI functionality.

The control/interface PWB contains push-button switches that provide backup control for the RF on/off and local/remote functions.

**Figure 1.2: Control/Monitor Stage**

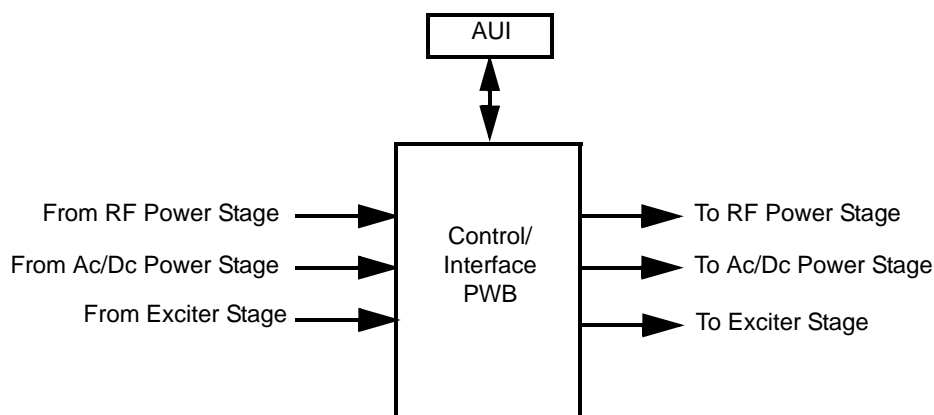

---

## RF POWER STAGE

See electrical schematics [SD-4](#), [SD-5](#) and [SD-6](#). The RF power stage includes all of the transmitter's 10 kW RF power blocks. The NX50 contains 5 RF power blocks.

Each RF power block contains four RF power modules and associated relays, a fan tray, and connections to the RF drive distribution PWB, PDM distribution PWB and rack interface PWB. Each RF power module accepts RF drive, PDM and control voltages from the exciter stage. B+, +48 V and +15 V dc voltages are input from the B+ distribution assembly and the rack interface PWB. The output of each RF power module is applied to a primary winding of a series combining transformer. The resultant combined output is applied to the RF output network.

To facilitate “on-air” servicing, each module has an associated relay that forces a contact closure across the appropriate primary winding of the series combining transformer when an RF power module is removed from the transmitter. When the transmitter is shut down, all relay contacts close, isolating the RF power modules from the output network and improving their immunity to lightning.

---

## RF OUTPUT NETWORK

See electrical schematic [SD-5](#) and [Figure 1.3](#). The combined RF output is filtered through an RF network consisting of two “T” networks with a shunt third harmonic trap, and then provided to the antenna system. The RF output is monitored by an RF current probe, RF voltage probe and RF sample probe. Samples from these probes are provided for control and monitoring purposes (see “[VSWR protection](#)” on [page 1-7](#)).

Figure 1.3: RF Output Network

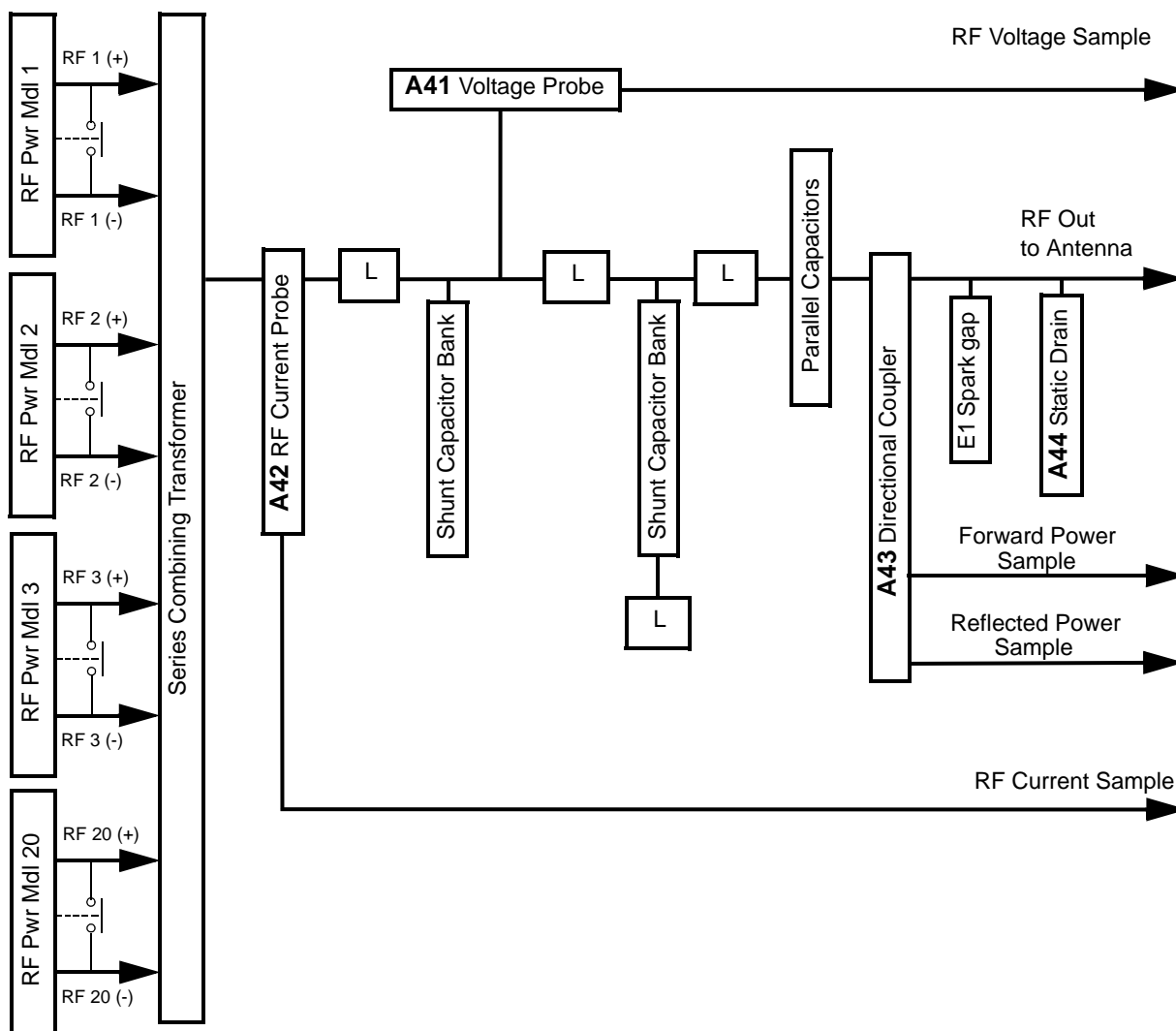

NOTE: The NX50 has 20 RF power modules, which are series combined.

---

## VSWR PROTECTION

The transmitter uses an advanced DSP based VSWR protection system. Circuitry in the RF output network (see [Figure 1.3 on page 1-6](#)) samples the RF voltage and RF current at the input to the harmonic filter. These current (I) and voltage (V) samples are applied to ADCs on the digital AM exciter PWBs. The digitized I and V signals are used to calculate the impedance (Z) at the combiner output. An FPGA performs high-speed calculations, so there is minimal response delay.

There are several types of VSWR protection, which continuously operate:

### PEAK REFLECTED POWER FROM DIRECTIONAL COUPLER

Fast VSWR protection set at 1.5:1 at 50 kW plus 100% peak modulation using the reflected power sample from the directional coupler (see [Figure 1.3 on page 1-6](#)) designed to shutback PDM (reduce power to zero) and disable RF drive in less than 300 ns.

### CALCULATED REFLECTED POWER FROM I AND V SAMPLES

The peak reflected power calculated by the FPGA is used to detect transient faults when the reflected power quickly increases due to arcing, lightning or short circuits. The peak reflected power limit - based on a VSWR of 1.5:1 at rated power plus 100% peak modulation - is 16 %. If this limit is exceeded, the transmitter's output power instantly reduces to 0 W. This is called a *Shutback* (see description below).

#### Shutback:

During a single shutback event (see [Figure 1.4 on page 1-8](#)), the transmitter reduces the output power to 0 W, and remains in that state for 300 ms. This allows time for an arc or transient fault to clear. After 300 ms, the output power exponentially ramps up (to the last power set point or the current ALC value, whichever is lower).

After 30 s, the transmitter returns to full power under control of the normal ALC. When a shutback occurs, an accumulator value is set to a normalized value of 1. This value decays at a rate of 1/60 of a second (0.0167 s) so after 60 s, the accumulator value returns to 0 and the shutback event is no longer in memory.

#### Cutback:

A cutback occurs after multiple shutback events. When three shutback events occur within a 15 s period, the shutback accumulator exceeds the cutback threshold (2.5). The transmitter responds by limiting the output power to 85% of the previous power set point or the power at which the shutback event occurred. When multiple cutback events occur, the output power is reduced by 85% of the current level after each event. The minimum cutback power level is 2% of full carrier power. Further cutbacks will not decrease the power beyond this point. When the transmitter is recovering from a cutback event, the accumulator must first reach 0, which takes 60 s. After that, transmitter power is gradually restored to full power according to the curve shown in [Figure 1.5 on page 1-9](#).

Figure 1.4: Shutback Event

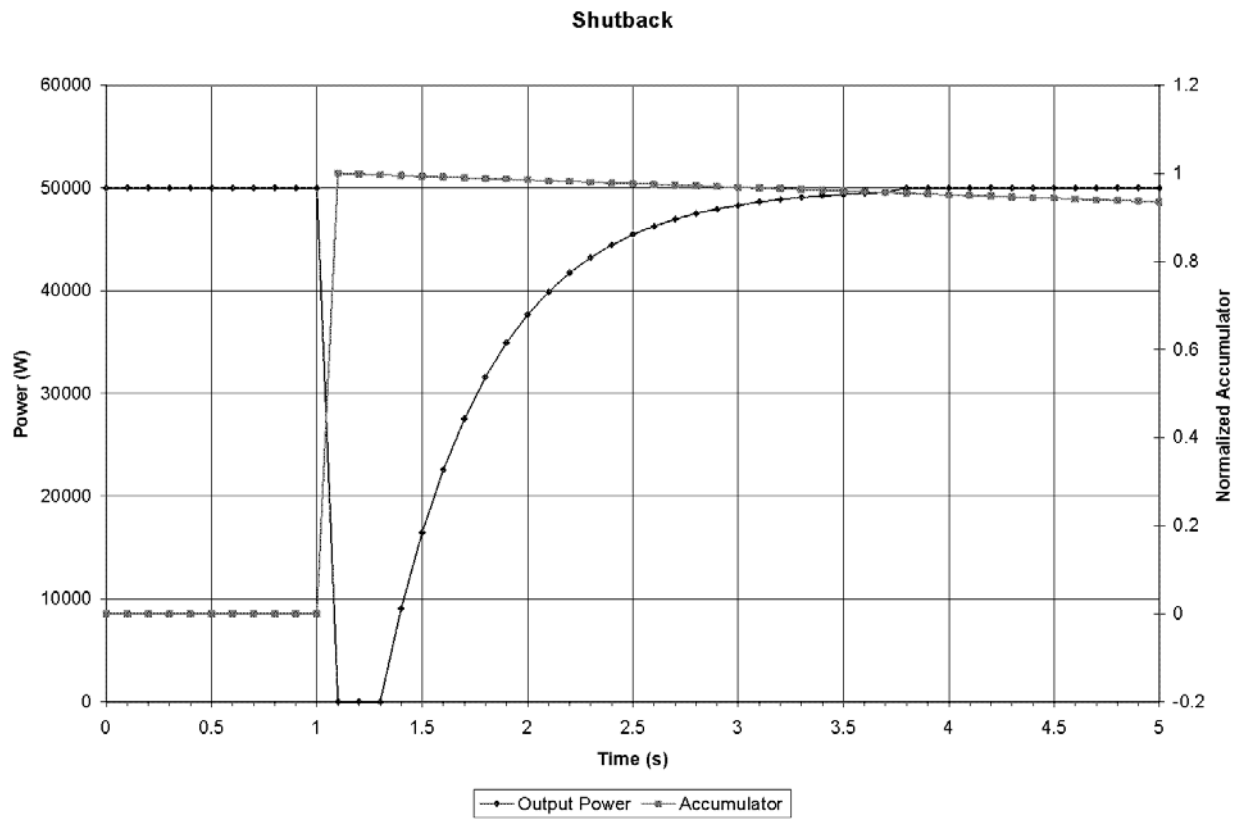

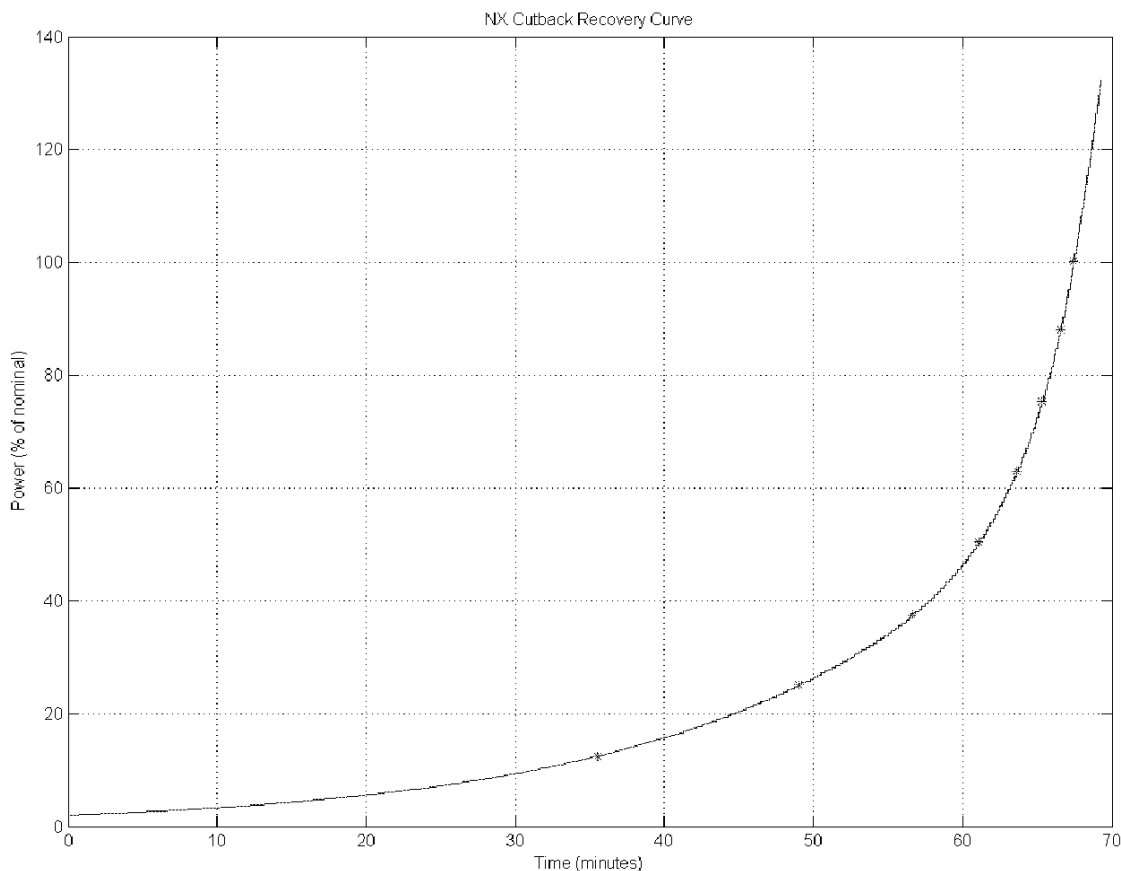

**Figure 1.5: Cutback Recovery Time**

#### AVERAGE REFLECTED POWER FOLDBACK

If the average reflected power, calculated over a nominal 5 s period, exceeds a limit of 4% of rated power, the output power is gradually reduced in order to maintain a reflected power that is less than this limit. This gradual reduction in power into high VSWR allows the transmitter to continue to operate into VSWR levels as high as 1.5:1 at full carrier power and even higher VSWR levels when the carrier power is reduced. This VSWR protection is intended to protect against short or open circuits when the transmitter is turned on, as well as non-transient faults such as a poorly tuned antenna system.



NX Series Transmitter Block Diagram

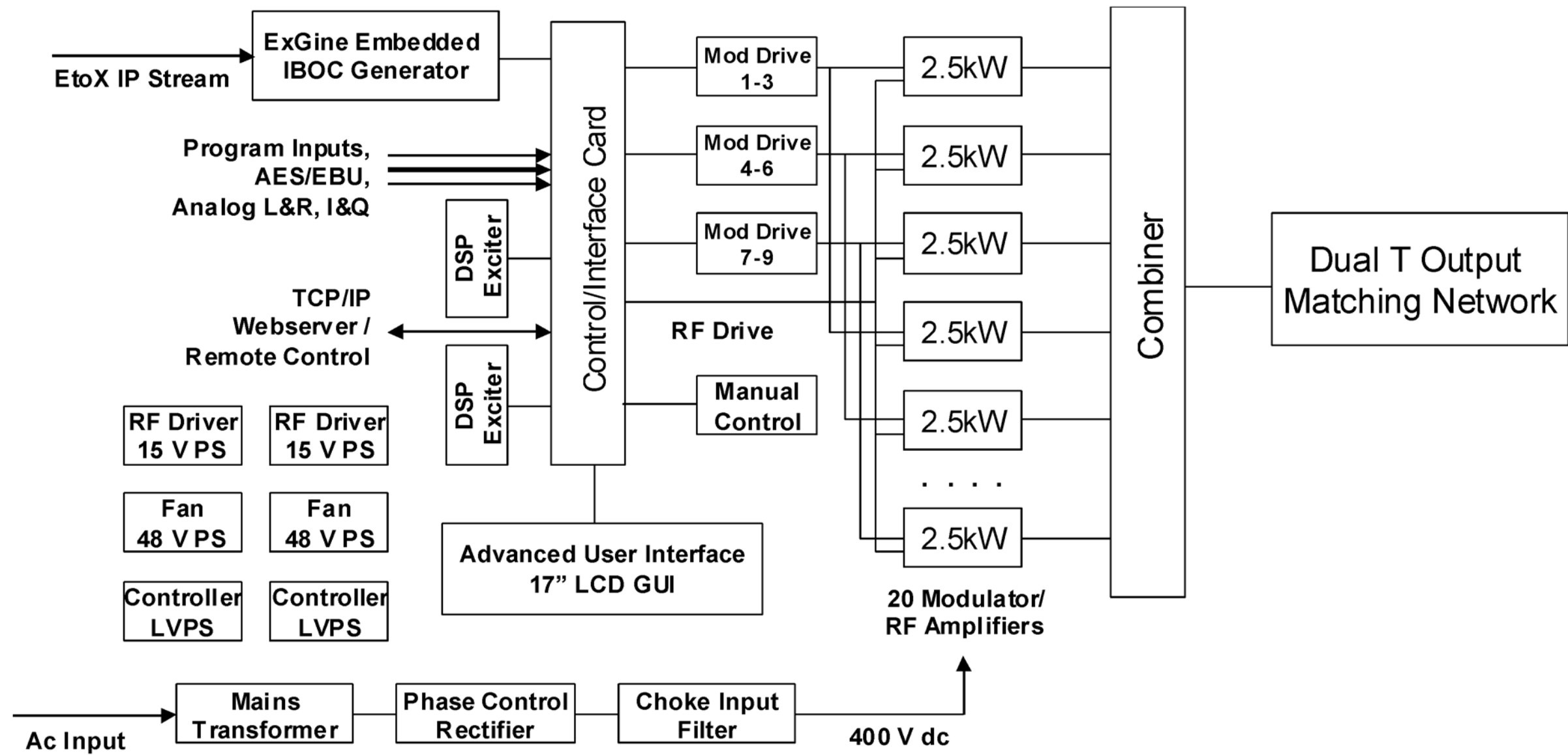

---

## SECTION 2: OPERATING THE TRANSMITTER

This section provides information about operating the NX50 transmitter:

- [Using the AUI - see page 2-2](#)
- [Home page - describing the first page - see page 2-17](#)
- [Menu page - describing transmitter operations on page 2-18](#)
- [Viewing Transmitter Log - see page 2-20](#)
- [Instrument Panels - viewing displays - see page 2-27](#)
- [Meters page - viewing real-time meters - see page 2-42](#)
- [Presets - editing operational settings - see page 2-48](#)
- [Preset Scheduler - see page 2-61](#)
- [Status - viewing transmitter status - see page 2-64](#)
- [User Accounts - see page 2-66](#)
- [User Settings - see page 2-71](#)
- [System Settings page - see page 2-89](#)
- [Precorrection Settings page - see page 2-97](#)
- [Changeover page - changing exciter transfer settings - see page 2-106](#)
- [Factory Settings - see page 2-107](#)
- [Remote I/O page - see page 2-116](#)
- [Playlist Manager - see page 2-121](#)
- [Using the safety interlock switch - see page 2-126](#)

---

## USING THE AUI

The NX50 has an advanced user interface (AUI) that is displayed on a 17-inch, colour LCD screen mounted on the front of the control cabinet (see [Figure 2.1](#)). The AUI is controlled locally by a touch screen or remotely using a PC and a web browser.

This section includes the following topics:

- ["Logging into the AUI"](#), on page 2-3
- ["Describing the AUI layout"](#), on page 2-8
- ["Navigating from page to page"](#), on page 2-10
- ["Summarizing the AUI pages"](#), on page 2-11

**Figure 2.1: Front Panel AUI**

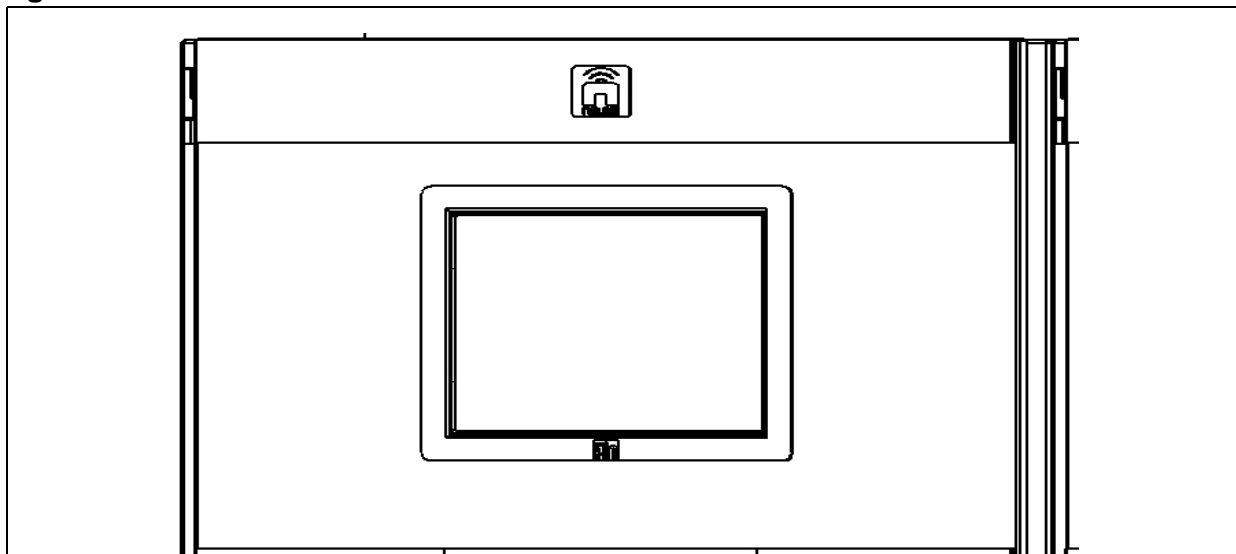

Information is displayed in a series of pages (screens) that serve specific transmitter functions. The AUI has the following configurable displays:

- Instrumentation panels ([“Instrument Panels - viewing displays”](#) on page 2-27)
- Real-time meters ([“Meters page - viewing real-time meters”](#) on page 2-42)
- Transmitter status ([“Status - viewing transmitter status”](#) on page 2-64)
- Events logs ([“Viewing Transmitter Log”](#) on page 2-20)
- Presets ([“Presets - editing operational settings”](#) on page 2-48)
- System settings ([“System Settings page”](#) on page 2-89)
- Pre-correction settings ([“Precorrection Settings page”](#) on page 2-97)
- User Accounts ([“User Accounts”](#) on page 2-66)
- Changeover ([“Changeover page - changing exciter transfer settings”](#) on page 2-106)
- User settings ([“User Settings”](#) on page 2-71)
- Remote input/output configuration ([“Remote I/O page”](#) on page 2-116)
- Scheduler ([“Preset Scheduler”](#) on page 2-61)
- Playlist ([“Playlist Manager”](#) on page 2-121)

See the complete AUI flow diagram illustrated in Figure 2.2 on page 2-5.

## LOGGING INTO THE AUI

The transmitter’s AUI provides a means to restrict local and remote access to transmitter control functions to authorized users only. User accounts can be pre-defined to set access restriction from read-only (no control) and full-administrative control.

Access the AUI using a web browser as follows:

1. Configure your network settings (see [“Setting up the network”](#) on page 2-72).

2. On your router or firewall software, open ports 3501 and 80 and close (restrict access to) port 22. If you are using RDS data, open port 7005. If you are using SNMP, open port 161.
3. Enter the IP address in a web browser's address field.
4. When properly configured, the login menu (see [Figure 2.3 on page 2-7](#)) appears. Your IP address and any login messages appear in a box at the top, beside the logo, and the current software version number appears along the bottom of the login window.

If the login menu does not appear, then your login may not be properly configured and you should consult the documentation for the **User Accounts** page (see [“User Accounts” on page 2-66](#)).

5. Log in to the AUI by entering the appropriate parameters in the login window.
  - In the **Language** field, click the down-arrow to review a drop-down menu displaying the available language options, and select one.
  - In the **User** field, enter the username. Default is “Nautel”.
  - In the **Password** field, enter the password. Default is blank.

**NOTE:** The Nautel AUI is factory configured with a default login username and password. Nautel recommends that you change the password to improve overall system security. See [“Changing the password” on page 2-68](#).

- Press **Submit** to accept your login parameters and display the AUI **Home** page ([Figure 2.4 on page 2-8](#)). Note: The opening screen (the **Home** page) will have the layout from the previous login session.

**NOTE:** If you do not have a user account, it must be set up by an existing user with proper permissions. See [“Adding a user” on page 2-68](#).

6. At any time, you can access the login menu by clicking the **Logout** button (and then **OK**) at the bottom, right-hand corner of the AUI (see [Figure 2.4 on page 2-8](#)).

**NOTE:** A maximum of ten remote connections may be logged in at a given time. If any connection is idle for more than 30 minutes, that user will be logged out, opening a spot for another user to log in.

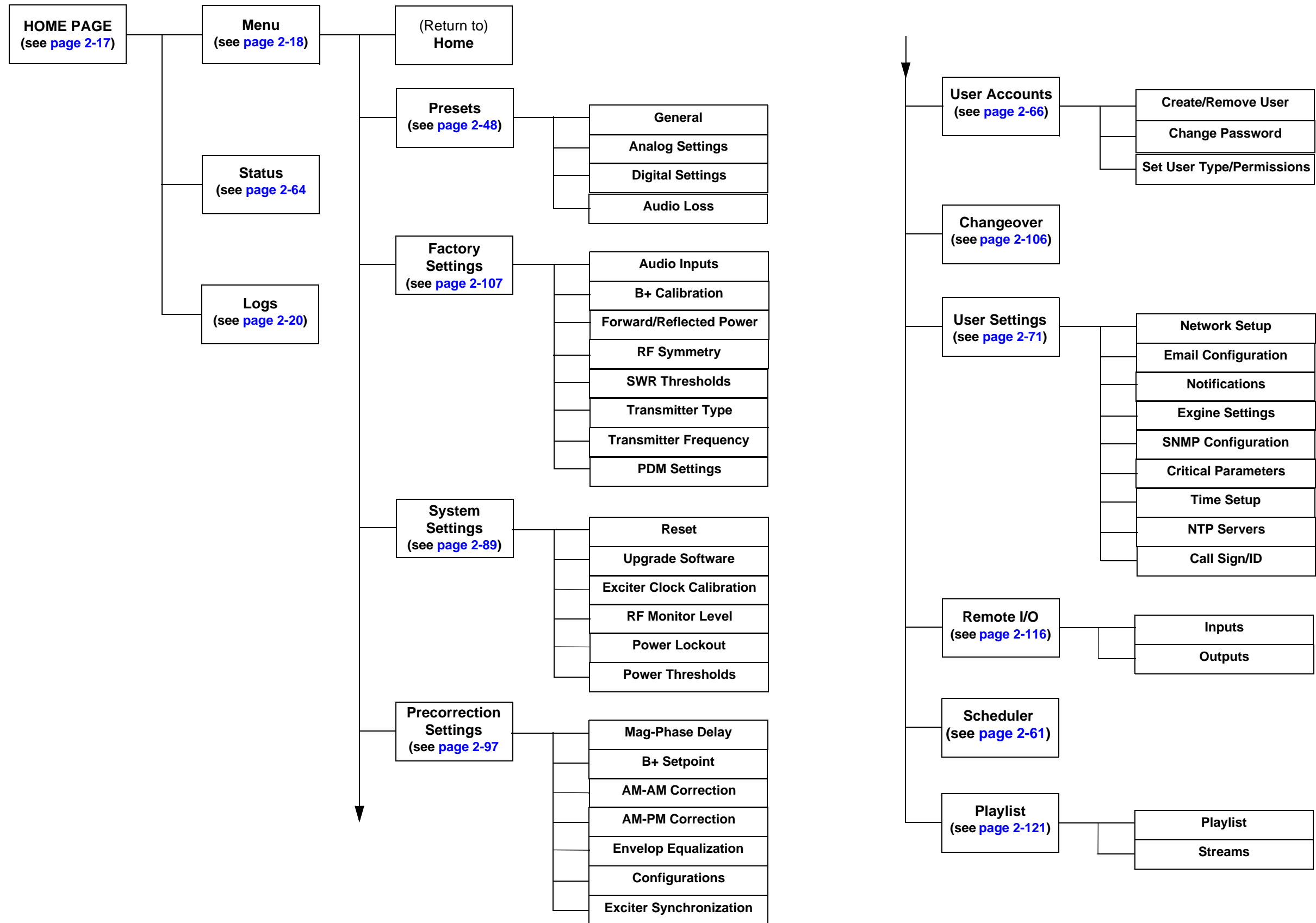

Figure 2-2: NX Transmitter AUI Flow Diagram



**Figure 2.3: AUI Login Menu**

IP Address and login messages

English (1.0)  
Türk (1.0)  
中文 (1.1)  
Espaniol (1.0)

Language English (1.0)

User

Password

Submit

Version: 3.3.1

Connected to 10.0.96.55:3501  
Please enter a username and password.

Software version

Access the AUI locally as follows:

The transmitter's front panel touch screen allows viewing of the AUI pages, regardless of the login status, but you must log in and have the proper permission level to access functions that can alter transmitter control settings.

1. Ensure the transmitter is on or apply ac power to the transmitter.
2. If the **Local Autologin** feature is properly configured (see "[User Accounts](#)", on page 2-66), the AUI **Home** page will display without a login requirement.
3. If the **Local Autologin** feature is not configured, the login menu (see [Figure 2.3 on page 2-7](#)) will appear on the touch screen.
4. A keyboard menu appears on the display when you touch the **User** or **Password** field. Enter your User name and Password, then press **Submit**.

**NOTE:** If you do not have a user account, it must be set up by an existing user with proper permissions. See "[Adding a user](#)" on page 2-68

5. At any time, you can access the login menu by pressing the **Change User** button (and then **OK**) at the bottom, right-hand corner of the AUI (see [Figure 2.4 on page 2-8](#)).

## DESCRIBING THE AUI LAYOUT

The AUI begins with the *Home* page (Figure 2.4) and all navigation starts from this screen.

**Figure 2.4: Home Page**

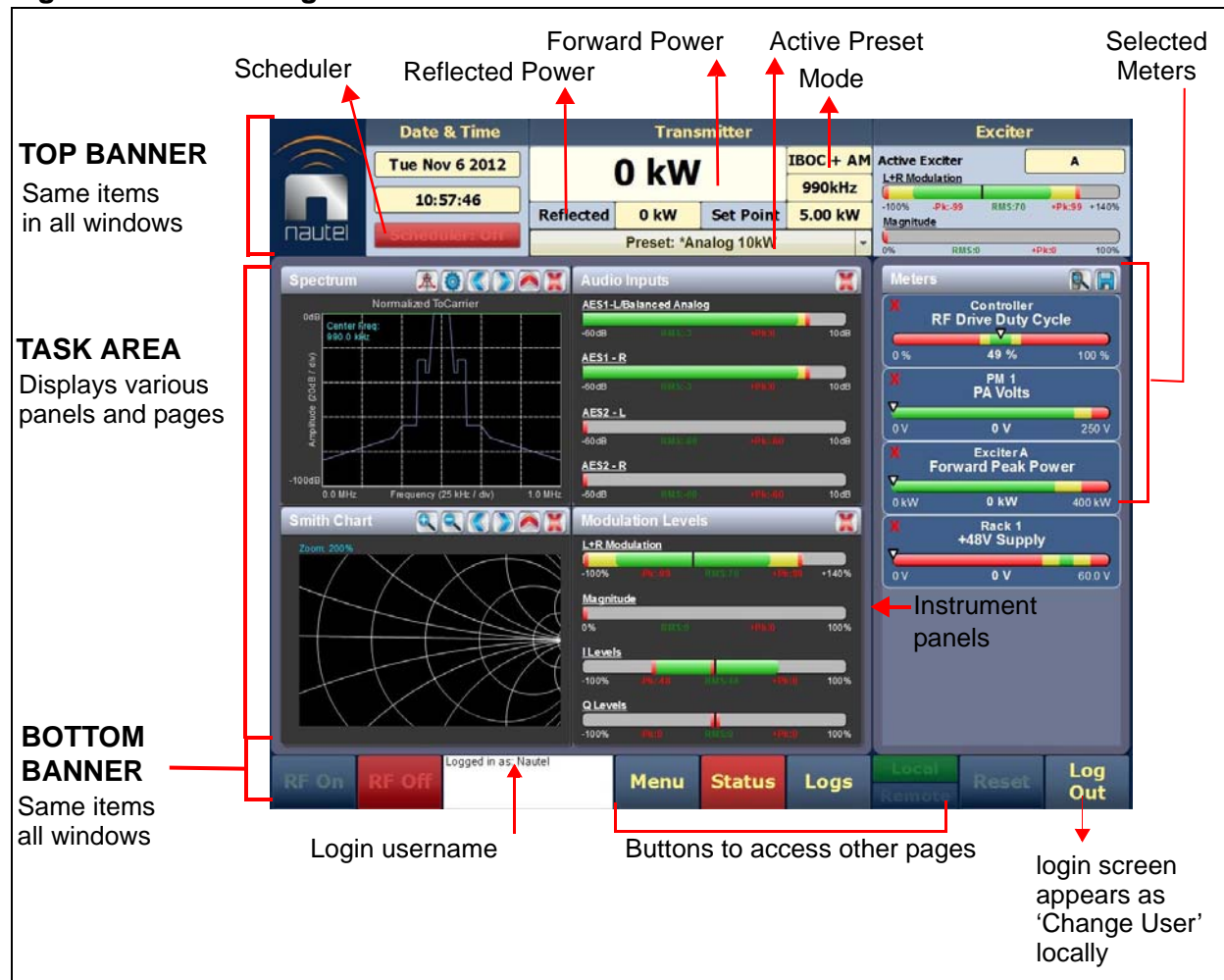

The “top banner” is permanent on all AUI pages and includes the following items:

- **Logo:** In any AUI page, press the logo to return to the *Home* page.
- **Date & Time:** Displays the current date and time. Press **Menu** > **User Settings** to access the *Time Setup* page to edit the time and date (“*Time Setup*” on page 2-84).
- **Scheduler:** Displays the on/off status of the Scheduler. Press the **Scheduler** button (upper panel) to toggle the status or press **Menu** > **Scheduler** to open the *Scheduler* page to edit scheduler rules (“*Preset Scheduler*” on page 2-61).

- **Transmitter:** Displays information about the active preset (transmission mode, frequency, set point, forward power and reflected power). Press **Menu > Presets** (bottom panel) to open the **Presets** page and edit this information (“[Presets - editing operational settings](#)” on page 2-48). The current setpoint can be edited directly by pressing in this area.
- **Preset:** Displays the active preset. Press this area to open the **Activate Preset** menu and select the active preset.
- **Exciter:** Displays the active exciter (A or B), a L+R modulation meter and a meter that displays the magnitude of the envelope with respect to the current peak power capability of the transmitter. The current level is marked in yellow, rms level is in green and the peak level is marked in red. Press the A or B button (upper panel) or press **Menu > Changeover** to open the **Changeover** page and edit this information (“[Changeover page - changing exciter transfer settings](#)” on page 2-106)

The “bottom banner” is also permanent on all AUI pages and includes the following buttons, some of which open other menus and displays:

- **RF On:** Press to enable the transmitter’s RF power stage.
- **RF Off:** Press to disable the transmitter’s RF power stage.
- **Menu:** Press to open a page that reveals transmitter control options that open other pages (“[Menu page - describing transmitter operations](#)” on page 2-18).
- **Status:** Press to open a page that reveals current alarms and status details (“[Status - viewing transmitter status](#)” on page 2-64).
- **Logs:** Press to open a page that reveals historical alarms and status records for the transmitter (“[Viewing Transmitter Log](#)” on page 2-20).
- **Local/Remote:** Press to identify which user (local or remote) controls the operational status of the transmitter. If **Local** is highlighted, remote users cannot change the setting. If **Remote** is highlighted, local users can still change the transmitter status.
- **Change User/Log Out:** Press to display a login menu. A keyboard menu appears when you press the **Username** or **Password** field. Enter your username and password, then press **Done**. If you do not have a user account, see "[User Accounts](#)", on page 2-66. The **Change User** button will display as **Log Out** while in remote operational control.

The “task area” displays the AUI functions such as transmitter status and hardware settings:

- **Instrument Panels:** Display up to four panels on the screen at one time. To reveal the instrument-panel options, press **X** in the upper right corner of one panel to close an existing panel, and then press the “cog” icon to display a menu of panels (“[Instrument Panels - viewing displays](#)” on page 2-27).
- **Meters:** Displays the real-time meters that provide a system review of the transmitter (“[Meters page - viewing real-time meters](#)” on page 2-42).

## NAVIGATING FROM PAGE TO PAGE

You navigate through the AUI screens from the *Home* page or from the *Menu* page (Figure 2.5).

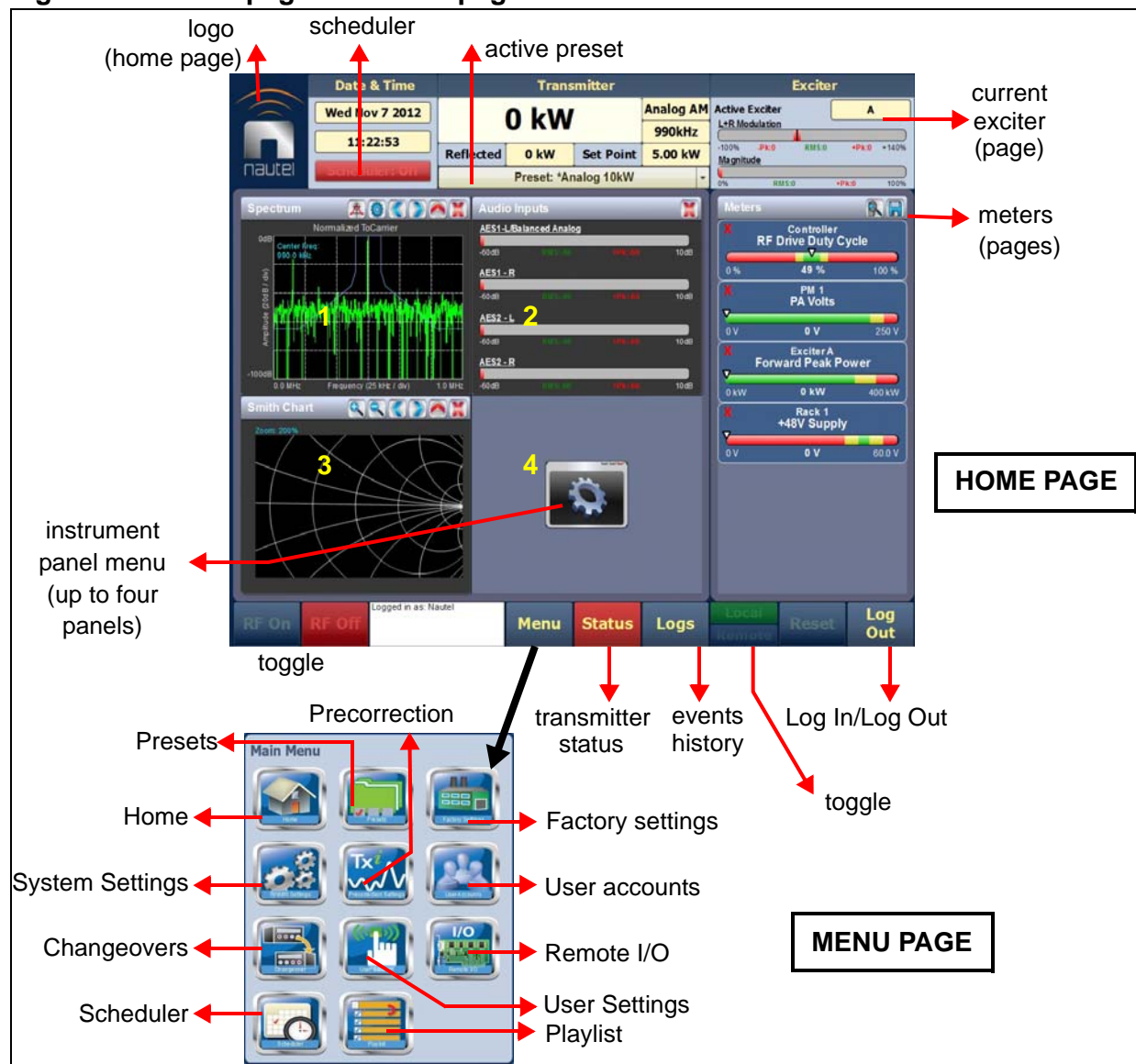

The *Home* page is the first screen to appear when you login into the AUI. You can return to this page from any AUI screen by pressing the logo (upper left corner) or by selecting **Menu > Home**. The *Menu* page is accessed from the “bottom panel” by pressing **Menu**.

**Figure 2.5: Home page and Menu page selection items**





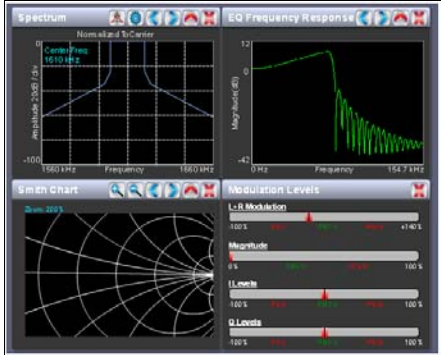
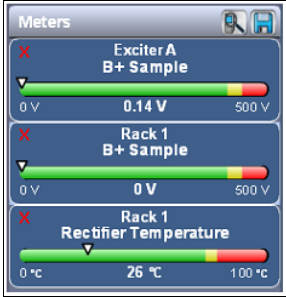
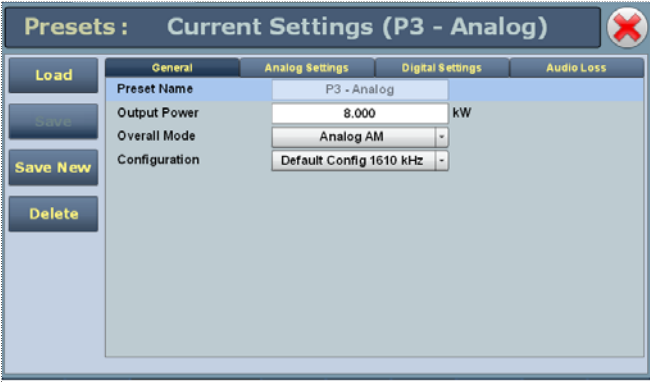

## SUMMARIZING THE AUI PAGES

Table 2.1 identifies the available AUI pages.

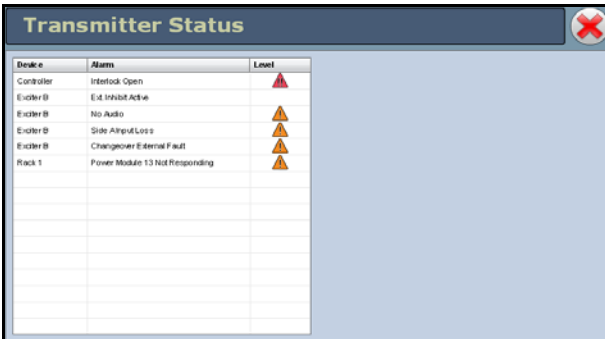

AUI Page	Function	See Page
<p>Home (first page)</p> <p>(available via local or remote operation)</p>	<p>Displays an overview of transmitter features, including various meters and instrument panels. Choose options and navigate to other pages.</p> 	<p>2-8</p>
<p>Menu</p> <p>(available via local or remote operation)</p>	<p>Choose options and navigate to other pages.</p> 	<p>2-18</p>
<p>Logs</p> <p>(available via local or remote operation)</p>	<p>View a history of transmitter events.</p> 	<p>2-20</p>

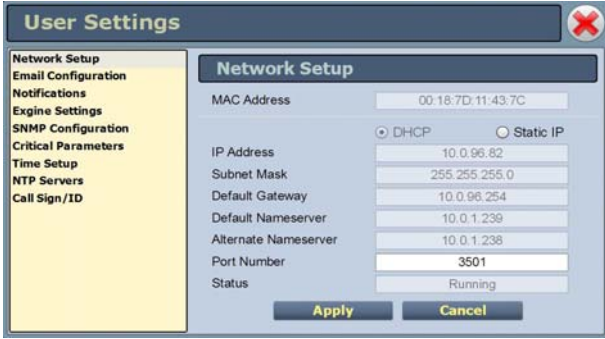
AUI Page	Function	See Page
<p>Instrument Panels</p> <p>(available via local or remote operation)</p>	<p>Choose the instrument panel option(s). 16 options are available. Up to four screens can appear on one page.</p> 	<p>2-27</p>
<p>System Review (Meters)</p> <p>(available via local or remote operation)</p>	<p>Choose meters for display.</p> 	<p>2-42</p>
<p>Presets</p> <p>(available via local or remote operation)</p>	<p>Activate and edit user-defined presets.</p> 	<p>2-48</p>

AUI Page	Function	See Page
<p>Scheduler</p> <p>(available via local operation or remote operation)</p>	<p>Create and edit scheduler rules.</p> 	<p>2-61</p>
<p>Transmitter Status</p> <p>(available via local or remote operation)</p>	<p>View transmitter's active faults.</p> 	<p>2-64</p>
<p>User Accounts</p> <p>(available via local or remote operation)</p>	<p>Set user permission rights and define user accounts.</p> 	<p>2-66</p>

AUI Page	Function	See Page
<p>User Settings</p> <p>(available via local or remote operation)</p>	<p>Set network information, configure email and alarm notification parameters, configure Exgine interface information, configure SNMP information, capture critical parameters, set time and date, enable/ configure NTP servers and set call sign/ID..</p> 	<p>2-71</p>
<p>System Settings</p> <p>(available via local or remote operation)</p> <p>** Screen configuration available local only</p>	<p>Reboot AUI or active exciter, perform software upgrades, configure screen settings (local only) calibrate exciter clock, set the RF monitor sample level, configure power lockouts and configure low forward power thresholds.</p> 	<p>2-89</p>

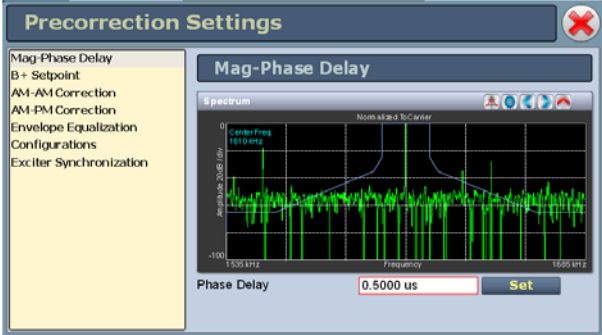

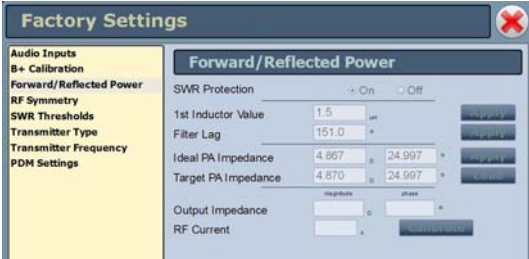
AUI Page	Function	See Page
<p>Precorrection Settings</p> <p>(available via local or remote operation)</p>	<p>Control various critical parameter functions using the Precorrection page.</p> 	<p>2-97</p>
<p>Changeovers</p> <p>(available via local or remote operation)</p>	<p>Set the main exciter and auto exciter changeover functions..</p> 	<p>2-106</p>
<p>Factory Settings</p> <p>(available via local or remote operation)</p>	<p>Displays the settings for the transmitter that are set at the factory.</p> 	<p>2-107</p>

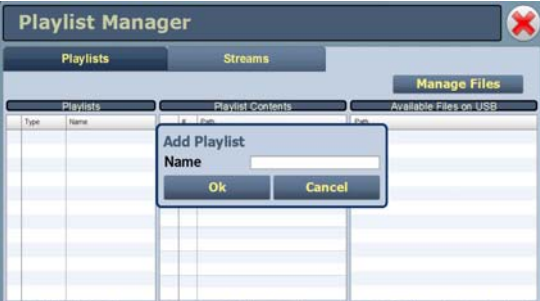
AUI Page	Function	See Page
<p>Remote I/O</p> <p>(available via local or remote operation)</p>	<p>Define remote digital inputs and outputs.</p> 	<p><a href="#">2-116</a></p>
<p>Playlist Manager</p> <p>(available via local or remote operation)</p>	<p>Manage the audio playlist files.</p> 	<p><a href="#">2-121</a></p>

## HOME PAGE - DESCRIBING THE FIRST PAGE

The *Home* page (Figure 2.6) is the first screen to appear after you log into the AUI. It contains the images that were last viewed in the AUI, from the previous login session.

You can return to the *Home* page, from any screen, by pressing the logo in the upper, left corner or by pressing Menu>Home.

Figure 2.6: Home page example



The *Home* page layout is provided in the AUI description (see Figure 2.4 on page 2-8.).

## MENU PAGE - DESCRIBING TRANSMITTER OPERATIONS

The **Menu** page displays icons that link to pages that control various transmitter operations (Figure 2.7). Press **Menu** in the “bottom panel” of an AUI screen to open this window of options.

Figure 2.7: Menu Page

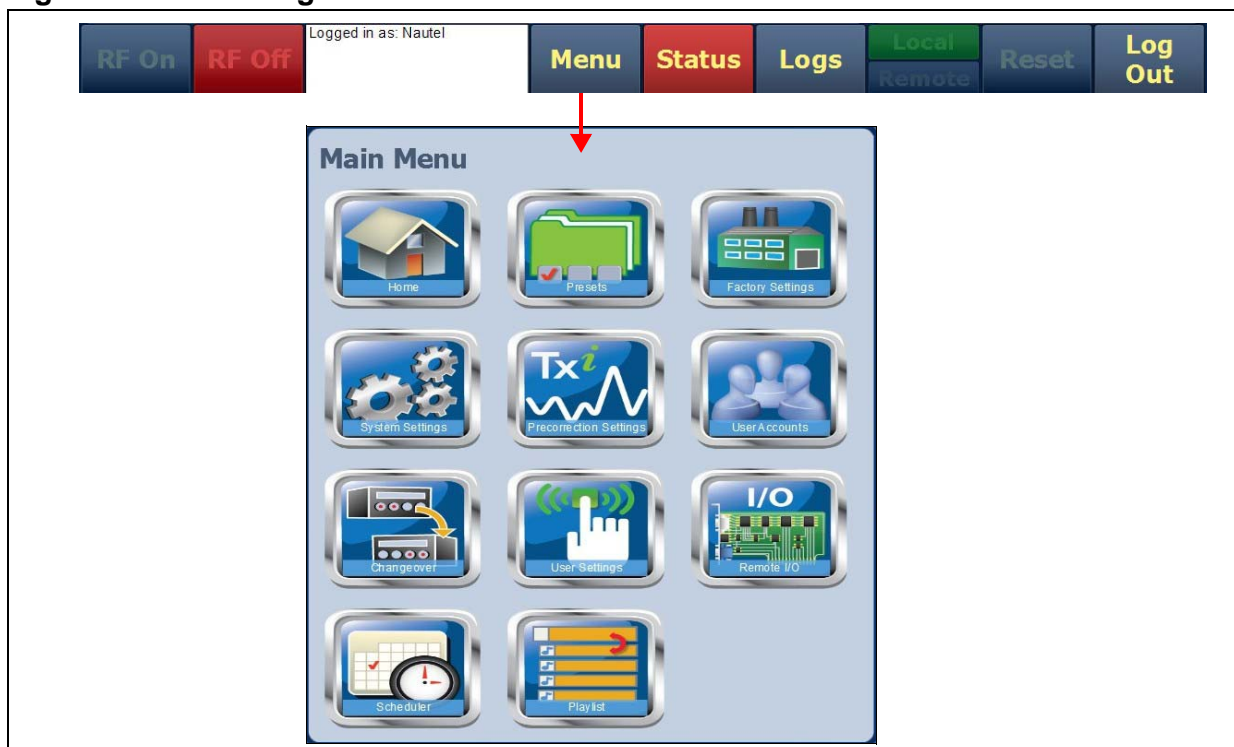

From this page, you can select the following operations:

- Press **Home** to return to the home page (“Home page - describing the first page” on page 2-17).
- Press **Presets** to open screens related to presets (“Presets - editing operational settings” on page 2-48).
- Press **Factory Settings** to open a window where you can view the factory settings for the transmitter (“Factory Settings” on page 2-107).
- Press **System Settings** to access pages that allow you to reset the AUI or active exciter, perform software upgrades, calibrate exciter clock, and set power lockouts and power thresholds (“System Settings page” on page 2-89).

- Press **Pre correction Settings** to control various critical functions related to pre correction, ([“Pre correction Settings page” on page 2-97](#)).
- Press **User Accounts** to access a page that displays a list of users with access to the AUI and, depending on permission level, allows you to access user accounts ([“User Accounts” on page 2-66](#)).
- Press **Changeovers** to access a page that allows you to set the main (active) exciter and setup the automatic exciter changeover ([“Changeover page - changing exciter transfer settings” on page 2-106](#)).
- Press **User Settings** to access a page that allows network configuration, email configuration and alarm notifications, setting of Engine parameters, SNMP configuration, capturing critical parameters, setting date and time, enabling and configuration of NTP servers and setting call sign ([“User Settings” on page 2-71](#)).
- Press **Remote I/O** to access a page that allows configuration of digital inputs and digital outputs ([“Remote I/O page” on page 2-116](#)).
- Press **Scheduler** to access a page that allows you to schedule preset changes ([“Preset Scheduler” on page 2-61](#)).
- Press **Playlist** to access the built in audio player and add/manage playlists, Icecast or Shoutcast streams. ([“Playlist Manager” on page 2-121](#)).

## VIEWING TRANSMITTER LOG

You can view the NX50's events log using the [Log page](#) - see [Figure 2.8](#). This page shows a configurable log of all transmitter events. To view the [Log page](#), click the **Log** button in the bottom banner of the AUI screen.

**Figure 2.8: Log page**

The screenshot shows the 'Transmitter Log' window with a 'Log Manager' header and a table of 157 matches. The table has columns for Device, Event, State, Severity, and Time of Event. On the right side of the table, there are navigation icons: a top arrow, a down arrow, an up arrow, a down arrow, and a bottom arrow. Red arrows point from text labels to these icons.

Device	Event	State	Severity	Time of Event
PM [0x1860]	External Disable Active	✓	⚠	Wed Feb 13 2013 09:44:41 740ms
Exciter A	Ext. Inhibit Active	⚠		Wed Feb 13 2013 09:44:34 880ms
Exciter B	B+ Compensation Inhibited	✓		Wed Feb 13 2013 09:44:34 880ms
Exciter B	Low Forward Power Threshold	✓	⚠	Wed Feb 13 2013 09:44:34 860ms
Exciter B	Ext. Inhibit Active	⚠		Wed Feb 13 2013 09:44:34 860ms
Exciter B	B+ Compensation Inhibited	⚠		Wed Feb 13 2013 09:44:33 080ms
Controller	RF On/Off	⚠	⚠	Wed Feb 13 2013 09:44:32 860ms
Exciter B	Low Forward Power Threshold	✓	⚠	Wed Feb 13 2013 09:44:13 100ms
Exciter B	Power Below Setpoint	✓	⚠	Wed Feb 13 2013 09:43:00 980ms
Exciter B	Power Below Setpoint	⚠	⚠	Wed Feb 13 2013 09:42:45 020ms
Exciter B	Low Forward Power Threshold	⚠	⚠	Wed Feb 13 2013 09:42:34 960ms
Exciter B	Low Forward Power Threshold	⚠	⚠	Wed Feb 13 2013 09:42:34 960ms

Annotations on the right side of the screenshot:

- Selects item at top of current page
- Selects next lower page
- Scrolls up one item
- Scrolls down one item
- Selects next higher page
- Selects item at bottom of current page

Maximum 100 items per page

Maximum 20 pages per batch (2000 items)  
(use filtering to view older batches)

The main screen displays a chronological listing of events. Depending on the selections made in the [Log Manager](#) screen (see ["Managing the Log"](#), on page 2-21), the events displayed may be filtered by the originating device [Controller, Exciter, Rack or PM (power module)], and the time of occurrence. A maximum of five batches (10,000 items) are stored on the AUI. Older items are discarded.

Refer to the *NX50 Troubleshooting Manual* to cross-reference the alarm name to possible causes and troubleshooting tips.

The number of log matches displayed is shown below the **Log Manager** button (e.g., 157 Matches Sorted by Time of Event). You can scroll through the list using the scroll bar or the up and down arrow buttons to the right of the scroll bar. When there are more than 100 matches in the list, a **Page #/#** tab will appear to allow viewing of further listings. In this case, click on **Page #/#**, select the desired page from the **Select a Page** window, then click **OK** to view that page or **Cancel** to return to the **Transmitter Log** page. You can also scroll through the pages using the appropriate arrow button on the right-hand side of the display (see [Figure 2.8 on page 2-20](#)). The columns in the display indicate specific information about the event:

- **Device** indicates the origin device of the event (Controller, Exciter, Rack, RF Module, etc.).
- **Event** indicates the event name.
- **State** indicates whether the event is active (red bell) or cleared (green checkmark) and in some cases, indicates whether the RF was turned on or off (see **Legend** under **Log Manager**, [Figure 2.13 on page 2-26](#)).
- **Severity** indicates how the event affects transmitter operation
  - a single yellow ! indicates low severity (RF output not affected)
  - a single orange ! indicates medium severity (RF output is reduced)
  - two red ! indicates high severity (RF output is inhibited)].
- **Time of Event** indicates the time and date that the event occurred.

## MANAGING THE LOG

You can manage the NX50 AUI's events log by clicking on the **Log Manager** button (see [Figure 2.9](#)). This screen provides options to perform various event monitoring operations such as filtering, copying, deletion and statistical analysis. Click **X** to close this window.

**Figure 2.9: Log Manager options (Filter Logs shown)**
**FILTER**

You can filter transmitter events based on their origin or date by clicking the **Filter Logs** button in the log manager (see [Figure 2.9](#)).

Click the **Device** drop-down arrow, and select the desired device type to filter events based on the type selected. Click the **OK** button or the **Cancel** button when done.

- **No selection** - displays all transmitter events
- **Controller** - displays controller events only
- **Exciter** - displays applicable exciter events only
- **Rack #** - displays applicable Rack # events only
- **PM #** - displays applicable power module # events only

Click the **Select All** radio button (default) to show all of the most recent events for the device type selected. A maximum of 2000 items (in 20 pages) can be displayed per 'batch'. Click the **OK** button or the **Cancel** button when done.

Click the **Filter by Date** radio button to filter events based on a selected date and time range, and the device type selected. Click the **OK** button or the **Cancel** button when done.

Click the **Get Next Batch** radio button to display the previously logged batch of events (up to 2000 items) for the device type selected. Click the **OK** button or the **Cancel** button when done.

Click the **Cancel** button to close this window and discard changes.



**COPY**

You can create a copy of all the logs in the selected list (copied to the remote user's computer clipboard) by clicking on the **Copy Logs** button in the log manager (see [Figure 2.10](#)). You can paste the tab-delimited text copy of the logs into a text editing program such as Word, Excel, Notepad, etc. Click **OK** or **Cancel** to close this window.

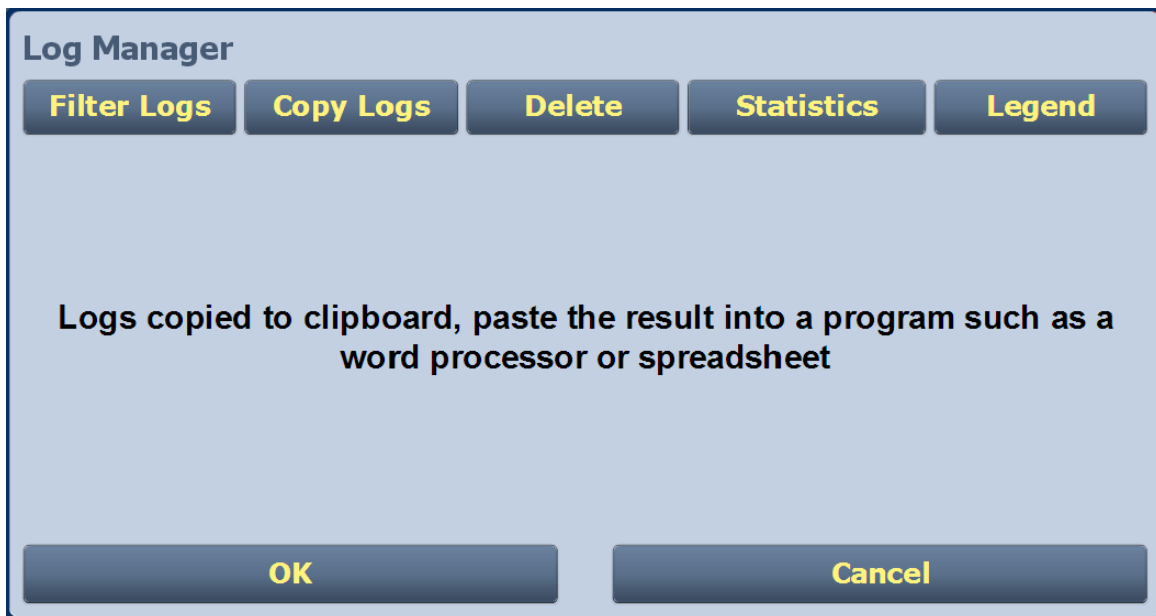
**Figure 2.10: Copy Logs**

## DELETE

You can delete all events or a selection of events by clicking on the **Delete** button in the log manager (see [Figure 2.11 on page 2-24](#)).

Click the **Delete All** checkbox and click **OK** to delete all events.

Click the **Delete by date** checkbox to allow deletion of events that occurred prior to (**Older than**) a user-specified date and time. Use the up and down arrows to select the date and time and click **OK** to delete the specified events.

Click the **Cancel** button to close this window and discard changes.

**Figure 2.11: Delete Logs**

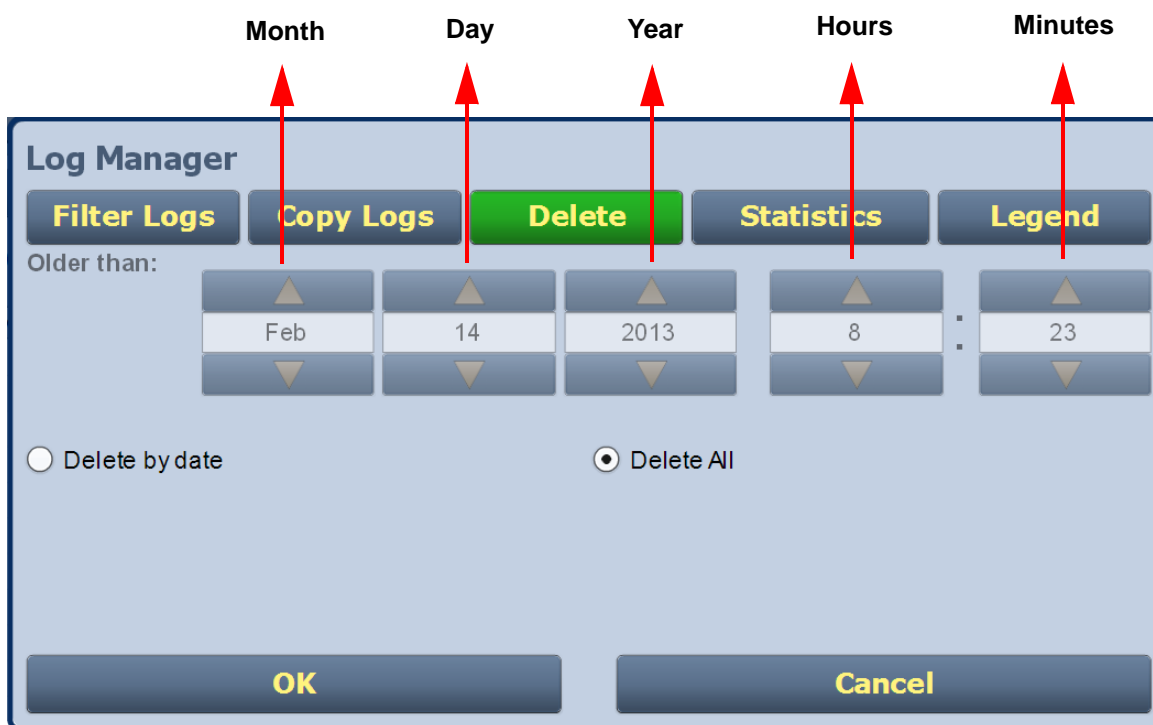

## STATISTICS

You can view statistical information on the events being displayed by clicking on the **Statistics** button in the log manager (see [Figure](#)). The **Statistics** screen groups similar events that occurred within the filtered period as well as the time and date of the earliest and latest event occurrence for each event type. You can move through the list using the scroll bar (if applicable) or the up and down arrow buttons to the right of the scroll bar. If the event log display spans over more than ten rows, use the arrows on the side of the display to scroll to more screens. Click **OK** or **Cancel** to close this window.

**Figure 2.12: Log Statistics**

Device	Event	Sever...	# Even...	Earliest	Latest
Controller	Local/Remote	!	13	09:29:12 Wed Feb 13 2013	15:52:28 Wed Feb 13 2013
Controller	RF On/Off	!	20	16:34:19 Tue Feb 12 2013	15:40:11 Wed Feb 13 2013
Controller	Main Exciter	!	2	14:51:51 Wed Feb 13 2013	14:52:08 Wed Feb 13 2013
Controller	Active Exciter	!	2	14:51:52 Wed Feb 13 2013	14:52:09 Wed Feb 13 2013
Controller	Sync Enable	!	8	10:53:12 Wed Feb 13 2013	13:53:47 Wed Feb 13 2013
Controller	PDM Latch	!!	1	09:16:47 Wed Feb 13 2013	09:16:47 Wed Feb 13 2013
Controller	Interlock Open	!!	9	16:47:44 Tue Feb 12 2013	15:52:37 Wed Feb 13 2013
Controller	Power Module Fault	!	2	09:42:17 Wed Feb 13 2013	09:42:19 Wed Feb 13 2013
Exciter A	Ext. Inhibit Active	!	21	16:34:20 Tue Feb 12 2013	15:40:13 Wed Feb 13 2013
Exciter A	No External 10MHz	!	8	10:53:14 Wed Feb 13 2013	13:53:49 Wed Feb 13 2013

The columns in the display indicate specific information about the events:

- **Device:** refers to the device that is associated with the alarm. The device options are Controller, Exciter, Rack and PM (power module).
- **Event:** describes the alarm (e.g., Local/Remote switch).
- **Severity:** identifies the seriousness of the alarm [a single yellow ! indicates low severity (RF output not affected); a single orange ! indicates medium severity (RF output is reduced); two red ! indicates high severity (RF output is inhibited)].
- **# Events:** indicates the number of times the same alarm has occurred for the same device.
- **Earliest:** indicates the first time of an alarm occurrence.
- **Latest:** indicates the last time of an alarm occurrence, If an alarm has only one occurrence (i.e., **# Events** column is 1), then the time in the **Earliest** column will be the same as the time in the **Latest** column.

**LEGEND**

Click on the **Legend** button in the *Log Manager* (see [Figure 2.13](#)) to display a legend that describes the meaning of the symbols shown in the **State** and **Severity** columns of the *Log* page. Click **OK** or **Cancel** to close this window.

**Figure 2.13: Log Manager - Legend**

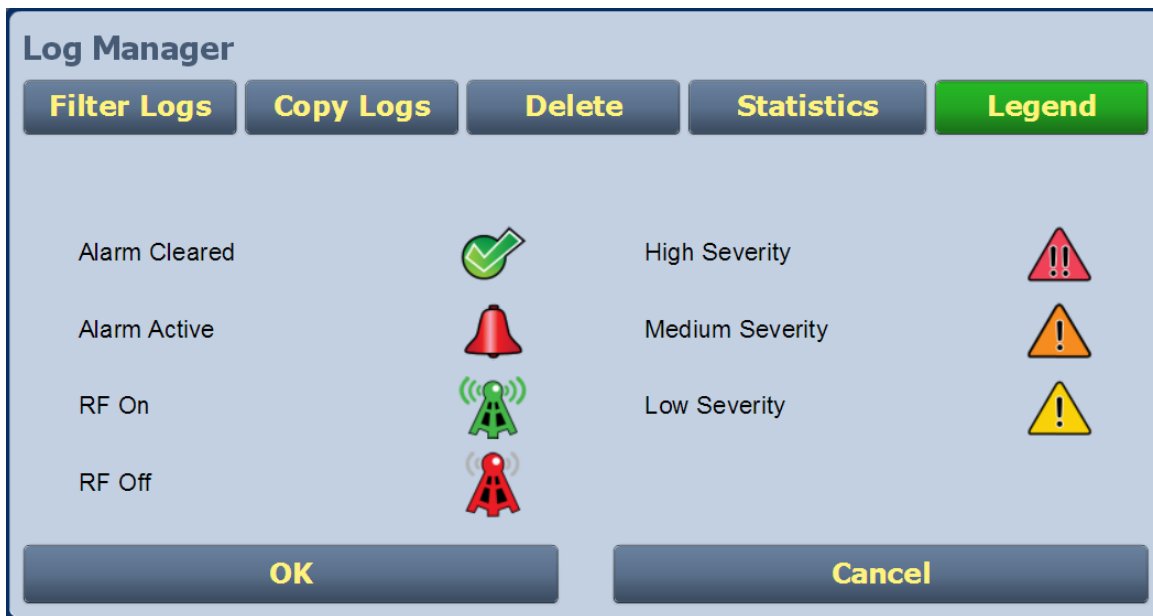

## INSTRUMENT PANELS - VIEWING DISPLAYS

The central area of the *Home* page displays up to four panels of instrument information. You can choose which panels to display from 12 possible information panels (Figure 2.14).

**Figure 2.14: Instrument Panel Options**

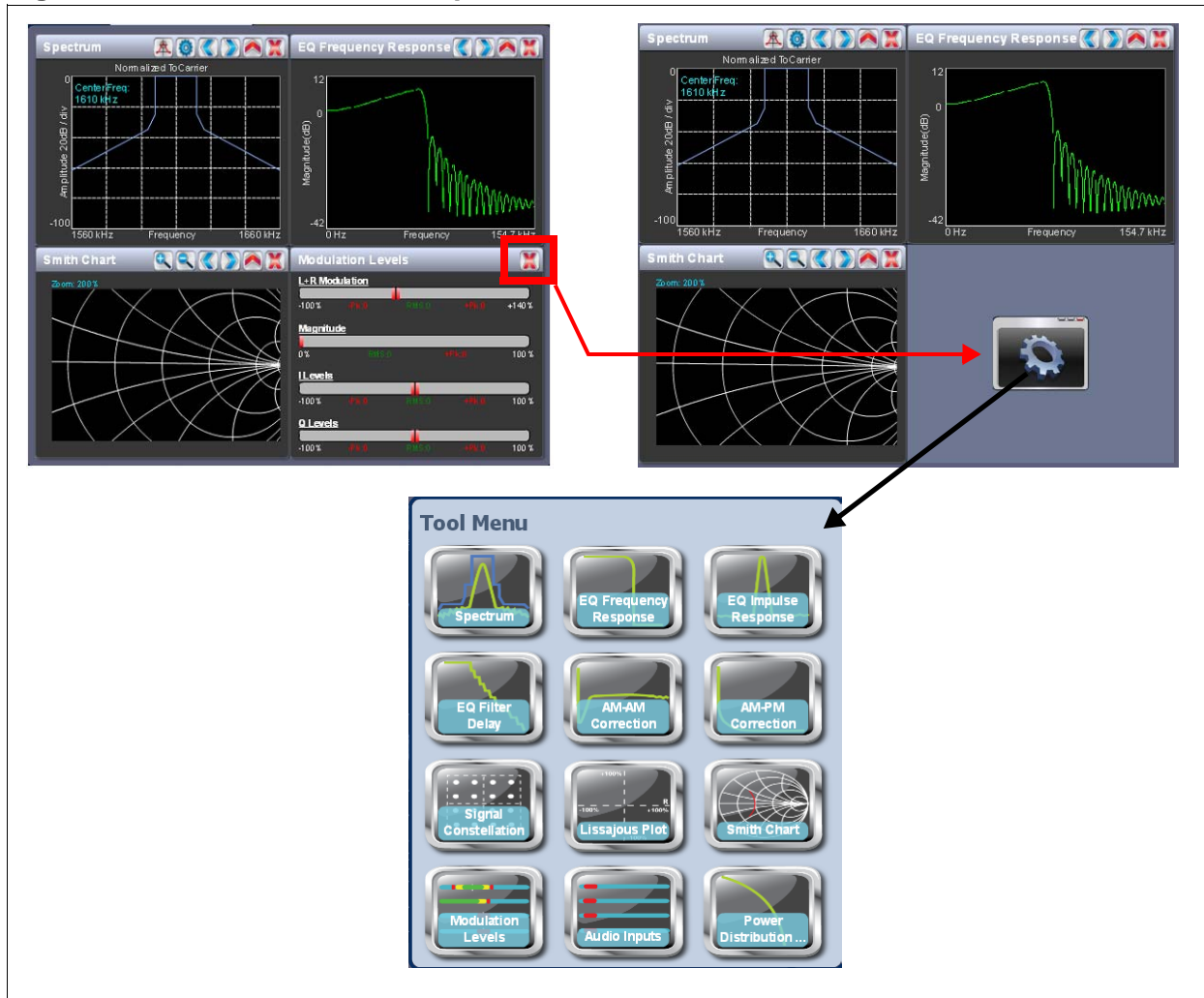

To view the instrument panel options, close an existing panel by pressing **X** (upper-right corner) and then press the “cog” icon to open the **Tool Menu**. Press an icon to display that panel.

Each panel has its own navigational controls. See [Table 2.1 on page 2-28](#) for a description of each tool menu panel and a cross-reference to more detailed information.

**Table 2.1: Tool Menu Panels**

<b>Tool</b>	<b>Description</b>	<b>See Page</b>
Spectrum	Displays a spectrum analyzer, capable of monitoring the transmitter's RF output spectrum and the spectrum of the signal generated by the exciter.	<a href="#">2-29</a>
EQ Frequency Response	Displays the frequency response of the exciter's EQ filter.	<a href="#">2-31</a>
EQ Impulse Response	Displays the impulse response of the exciter's EQ filter.	<a href="#">2-32</a>
EQ Filter Delay	Displays the delay of the exciter's EQ filter across its bandwidth.	<a href="#">2-33</a>
AM-AM Correction	Displays the amplitude compensation being applied to the magnitude signal.	<a href="#">2-34</a>
AM-PM Correction	Displays the compensation being applied to the phase signal.	<a href="#">2-35</a>
Signal Constellation	For IBOC mode only. Displays the phase and amplitude of the symbols being modulated within an OFDM sub-carrier as dots on a cartesian graph. Also displays timing and data carrier information.	<a href="#">2-36</a>
Lissajous Plot	Displays a Lissajous figure that represents the resultant vector (magnitude and phase) for the applicable channels (either L and R or I and Q).	<a href="#">2-37</a>
Smith Chart	Displays the impedance of the load as seen at the input to the transmitter's combiner.	<a href="#">2-38</a>
Modulation Levels	Displays L+R modulation, Envelope Magnitude and I/Q modulation. I/Q bar graphs are relevant for DRM or IBOC mode only.	<a href="#">2-39</a>
Audio Inputs	Displays the program input levels. Bar graph labels indicate the source of each display.	<a href="#">2-40</a>
Power Distribution	Displays a CCDF plot that indicates the probability of exceeding a given power level, based on the average power level. Aids in determining peak power capability.	<a href="#">2-41</a>

Figure 2.15: Spectrum Analyzer

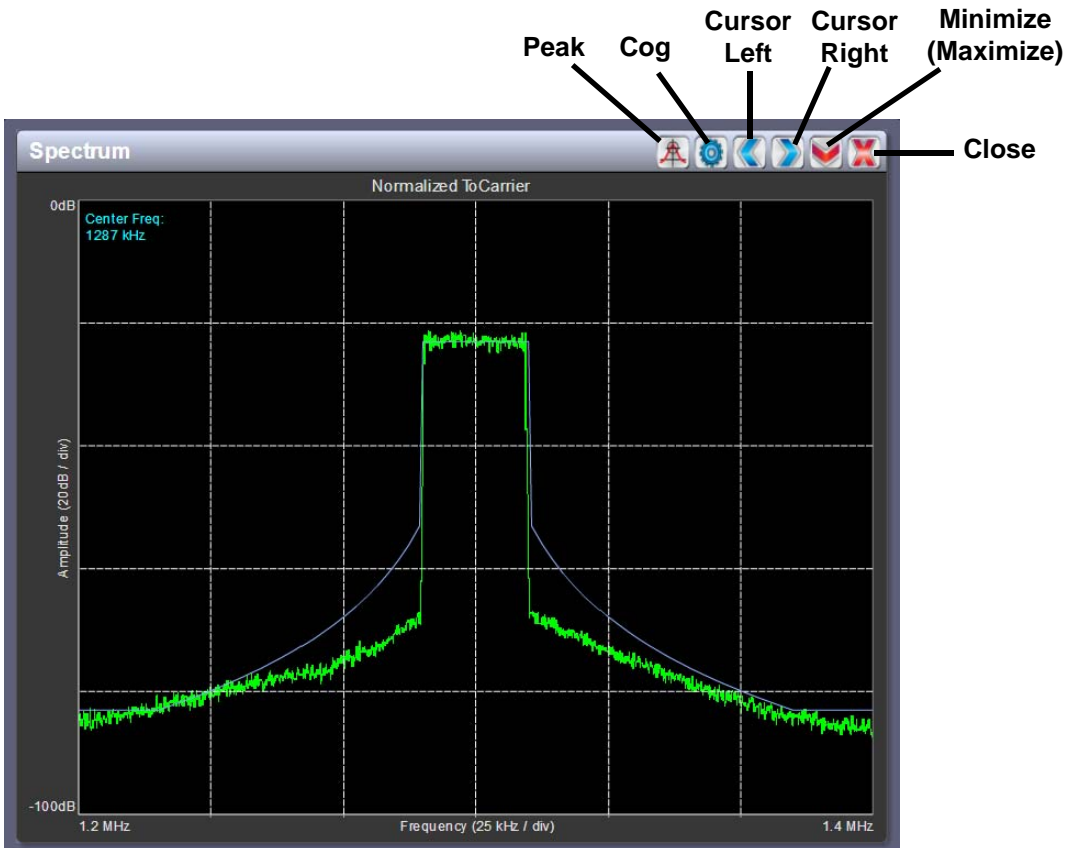

**SPECTRUM ANALYZER.** See Figure 2.15. The carrier level is normalized to its unmodulated level at 0 dB. The graph center is always at the carrier frequency, as defined by the Exciter's set Frequency value.

Masks are shown based on transmission mode and are defined by the following standards:

- Analog AM standard: NRSC-2-B
- DRM and DRM+AM standards: ITU-R SM.328-11 and ITU-R SM.1541-4
- IBOC and IBOC+AM: NRSC-5-C

**NOTE:** Any spurious emissions that are displayed are a product of the spectrum analyzer and are not actually present on the transmitter output.

Touch on the panel to display a cursor on the trace in the approximate area. The cursor position (frequency and amplitude) is shown in the upper, right-hand corner of the panel. The center frequency is shown in the upper, left-hand corner of the panel. Touch in other areas of the spectrum analyzer panel to provide a coarse adjustment of the cursor position.

Use the left and right buttons to make fine adjustments.

Use the up or down button to maximize (if it was minimized) or minimize (if it was maximized) the panel size.

Use the “peak” button to place the cursor on the next successive peak (moving left to right) in the spectrum.

Use the “cog” button to gain access to spectrum settings (see [Figure 2.16](#)) such as:

- **Resolution Bandwidth:** determines the FFT bin size or the smallest frequency that can be resolved. Set between 90 Hz and 2500 Hz (default is 300 Hz). Decreasing this value provides better frequency resolution, but will increase the sweep time.
- **Span:** determines the start and stop frequencies of the analyzer with the carrier frequency always at the center. Set between 20 kHz and 300 kHz (default is 150 kHz).
- **Averages:** determines the number of averages that the analyzer performs per sweep. Set between 0 and 100 (default is 19).
- **Measurement Source:** determines the source of the spectrum plot (transmitter output, audio analyzer, etc.) that is being displayed. Selecting **TX Output** uses the exciter’s RF sample feedback signal to display the RF output spectrum. Selecting **Audio Analyzer** displays the composite baseband signal.
- **Clear Averaging:** resets the averaged signal shown on the spectrum analyzer.

**Figure 2.16: Spectrum Settings**

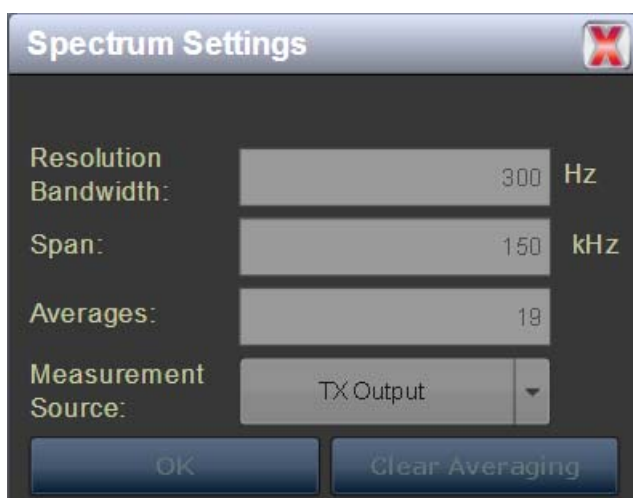



**EQUALIZER SCREENS.** The NX50's exciter includes a fixed equalizer to optimize audio performance. There are three menus available in the tool menu panels - EQ Frequency (see [Figure 2.17](#)), EQ Impulse Response (see [Figure 2.18 on page 2-32](#)) and EQ Filter Delay (see [Figure 2.19 on page 2-33](#)). Coefficients are selected based on your channel frequency. All frequencies shown are relative to the channel frequency.

**Figure 2.17: EQ Frequency Response**

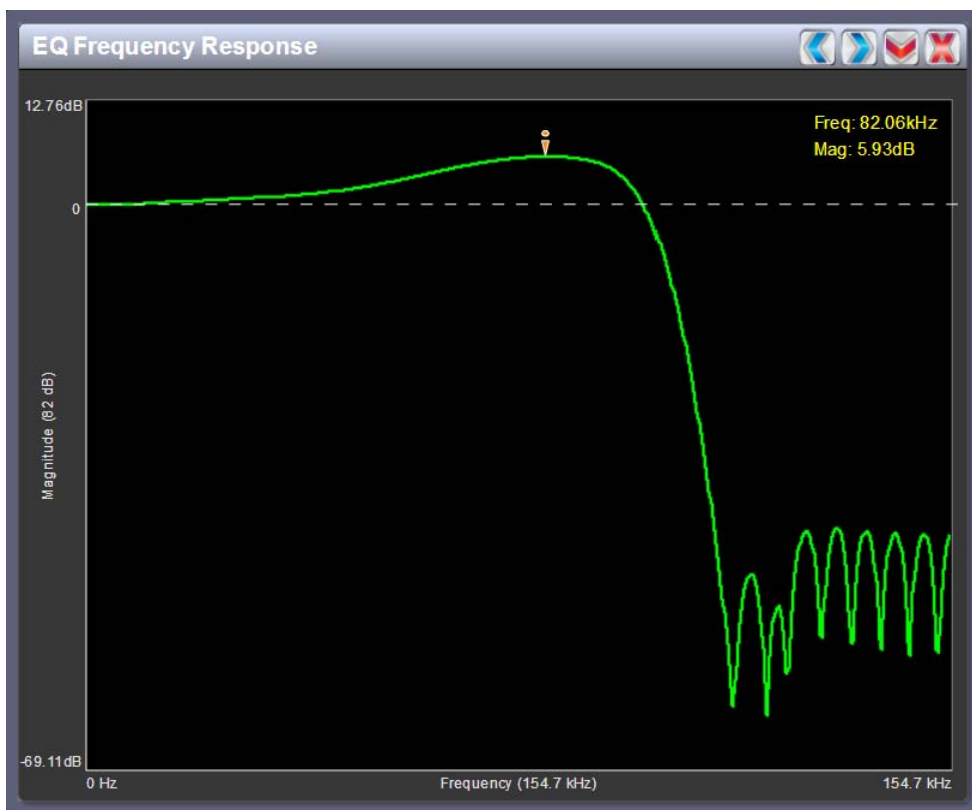

### **EQ FREQUENCY RESPONSE**

See [Figure 2.17](#). This panel displays the frequency response of the active exciter's EQ filter. Displays the gain of the filter with respect to frequency of the magnitude of the modulating signal. A dashed line is displayed at the 0 dB level.

Touch on the panel to display a cursor in the approximate area on the trace. The cursor position (frequency and magnitude) is noted in the upper, right-hand corner of the panel. Touch in other areas of the tool menu panel to provide a coarse adjustment of the cursor position.

Use the left and right buttons to make fine adjustments.

Use the up or down button to maximize (if it was minimized) or minimize (if it was maximized) the panel size.

**Figure 2.18: EQ Impulse Response**

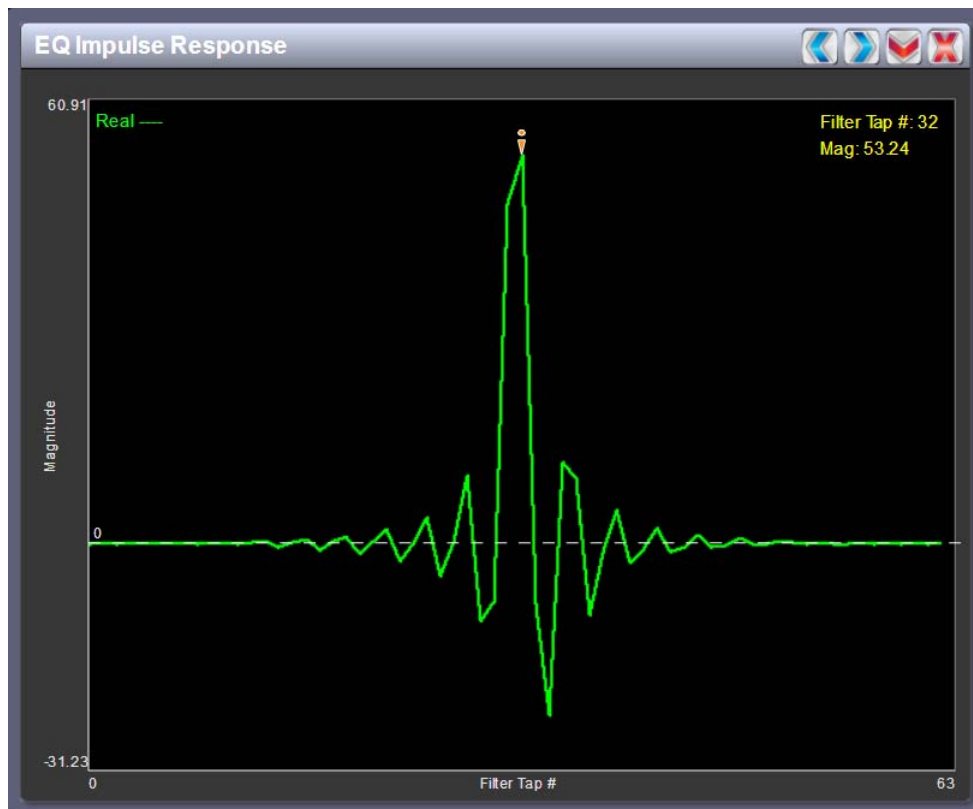

### EQ IMPULSE RESPONSE

See [Figure 2.18](#). This panel displays the impulse response of the modulator's EQ filter.

Touch on the panel to display a cursor in the approximate area. The cursor position (filter tap # and magnitude) is noted in the upper, right-hand corner of the panel. Touch in other areas of the tool menu panel to provide a coarse adjustment of the cursor position.

Use the left and right buttons to make fine adjustments.

Use the up or down button to maximize (if it was minimized) or minimize (if it was maximized) the panel size.

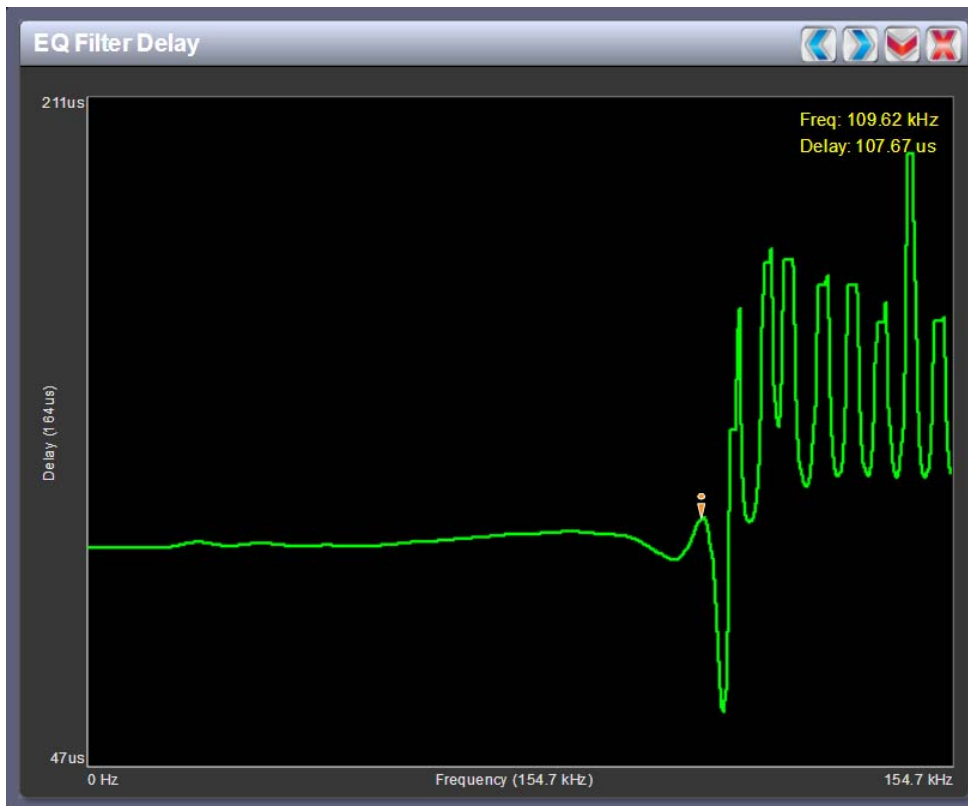
**Figure 2.19: EQ Filter Delay**

**EQ FILTER DELAY.** See [Figure 2.19](#). This panel displays the delay of the modulator's EQ filter across its bandwidth.

Touch on the panel to display a cursor in the approximate area. The cursor position (frequency and delay) is noted in the upper, right-hand corner of the panel. Touch in other areas of the tool menu panel to provide a coarse adjustment of the cursor position.

Use the left and right buttons to make fine adjustments.

Use the up or down button to maximize (if it was minimized) or minimize (if it was maximized) the panel size.

**AM-AM AND AM-PM CORRECTION SCREENS.** The exciter linearizes the transmitter's magnitude (envelope) path and drive signal by using two correction parameters - **AM-AM Correction** (see [Figure 2.20](#)) and **AM-PM Correction** (see [Figure 2.21 on page 2-35](#)), which can be viewed as tool menu panels.

**Figure 2.20: AM-AM Correction**

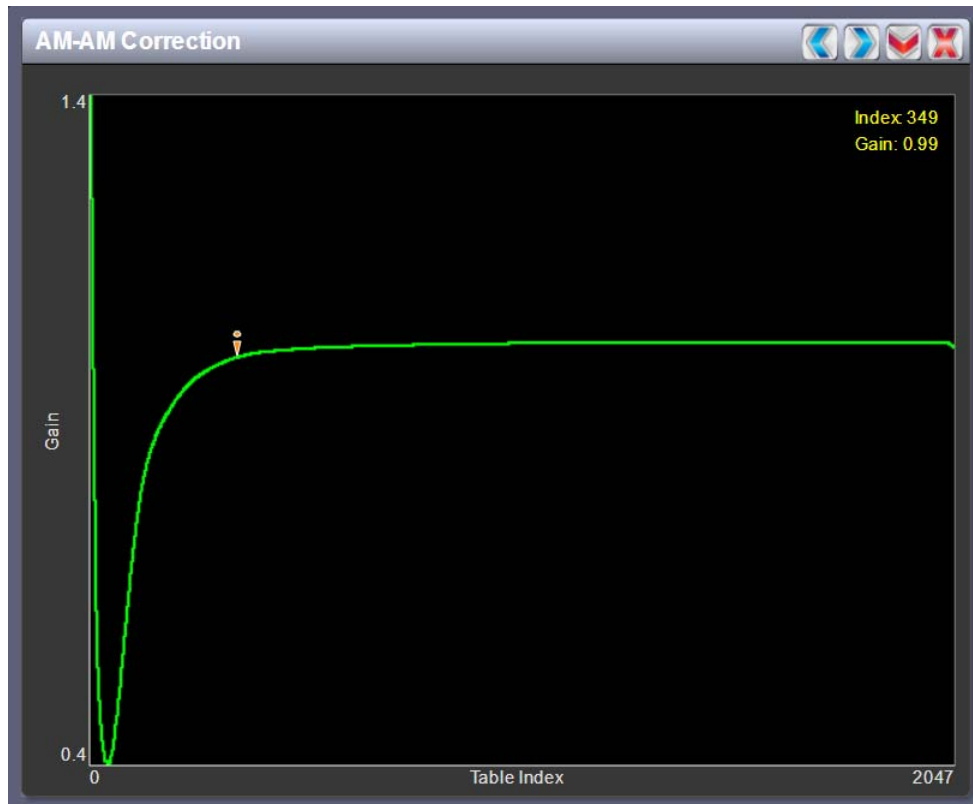

**AM-AM CORRECTION.** This panel displays the amplitude correction being applied to the magnitude signal. The x-axis represents the signal amplitude and the y-axis represents the gain correction applied for a given amplitude value.

Touch on the panel to display a cursor in the approximate area on the trace. The cursor position (LUT index and gain) is noted in the upper, right-hand corner of the panel. Touch in other areas of the tool menu panel to provide a coarse adjustment of the cursor position.

Use the left and right buttons to make fine adjustments.

Use the up or down button to maximize (if it was minimized) or minimize (if it was maximized) the panel size.

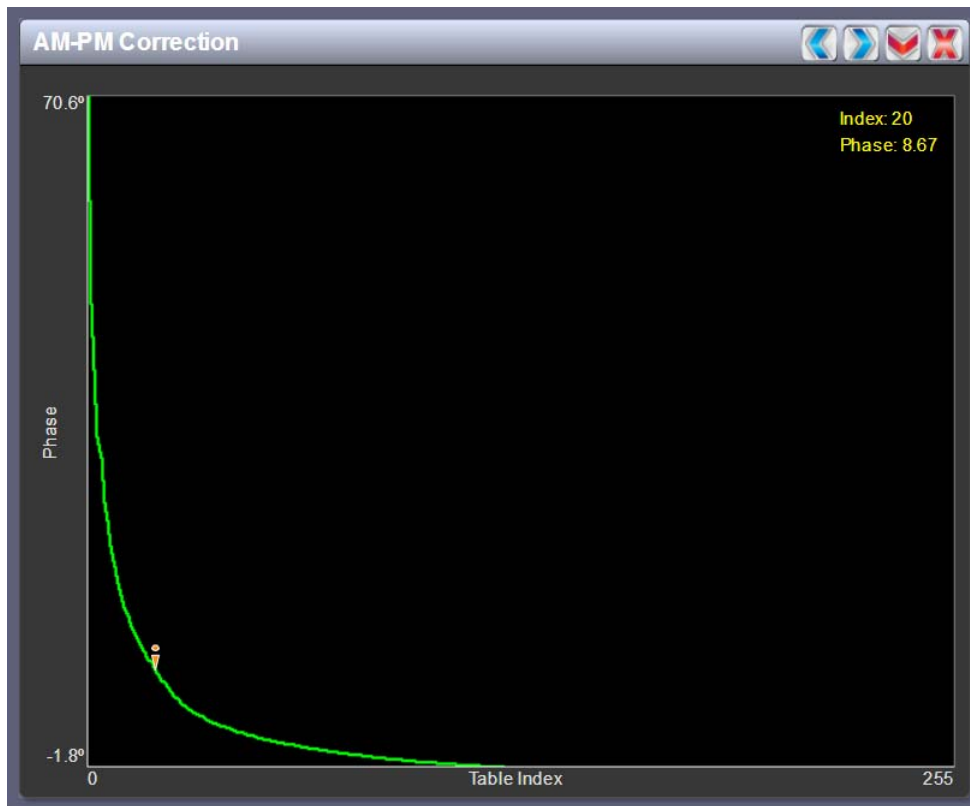
**Figure 2.21: AM-PM Correction**

**AM-PM CORRECTION.** This panel displays the phase correction being applied to the RF drive signal. The x-axis represents the signal amplitude and the y-axis represents the phase shift correction applied for a given amplitude value.

Touch on the panel to display a cursor in the approximate area. The cursor position (LUT index and phase) is noted in the upper, right-hand corner of the panel. Touch in other areas of the tool menu panel to provide a coarse adjustment of the cursor position.

Use the left and right buttons to make fine adjustments.

Use the up or down button to maximize (if it was minimized) or minimize (if it was maximized) the panel size.

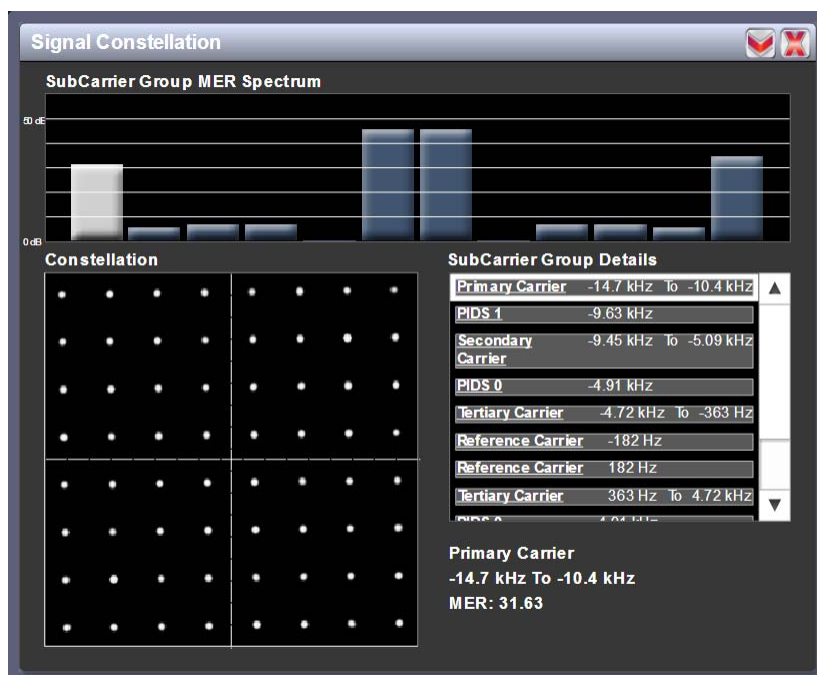
**Figure 2.22: Signal Constellation**

**SIGNAL CONSTELLATION.** See [Figure 2.22](#). In IBOC mode only, the exciter constantly measures the transmitter signal and performs basic demodulation of the digital carriers. The **Signal Constellation** panel displays the phase and amplitude of the symbols being modulated within an OFDM sub-carrier as dots on a cartesian graph. There are separate screens for each sub-carrier. You can select sub-carriers by pressing on the carrier representation in the **SubCarrier Group MER Spectrum** chart, or by selecting the desired subcarrier from the **SubCarrier Group Details** list. Typically, the dots will be grouped together around the ideal data points.

Sub-carrier group information is shown in the lower, right section of the screen. Displayed information includes the sub-carrier group name, the bandwidth that the selected carrier group occupies and the modulation error ratio (MER) for the selected carrier group. MER quantifies the performance of the transmitted digital signal as the ratio between the RMS power of the ideal signal and the RMS power of the received signal's error vector. A higher MER value is characteristic of a smaller error, and therefore a higher quality signal. The MER out of the transmitter is typically better than 20 dB, but can be significantly affected by external influences such as antenna impedance and bandwidth.

**NOTE:** When subcarriers are turned off in the Exgine settings, they will still appear in this screen, but the MER will be very high (i.e., 0 to 10 dB).

Use the up or down button to maximize (if it was minimized) or minimize (if it was maximized) the panel size.

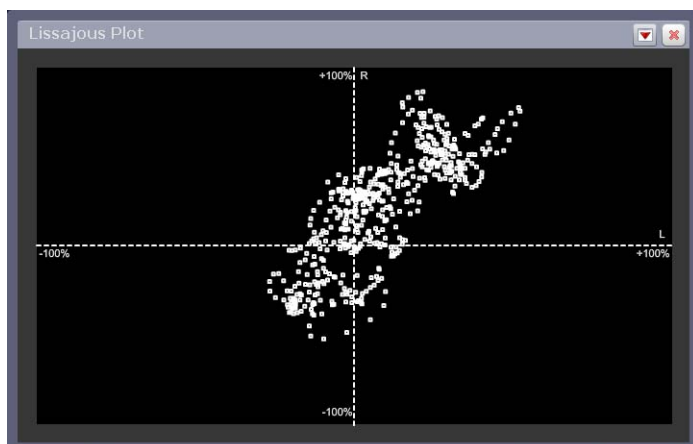
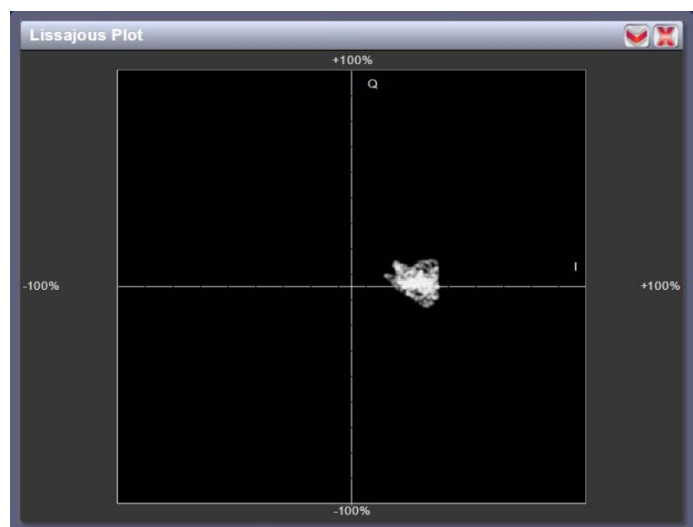
**Figure 2.23: Lissajous Plot****L and R mode****I and Q mode**

**LISAJOUS PLOT.** See [Figure 2.23](#). This panel displays a Lissajous figure that represents either L (left) and R (right) audio content or a representation of the digital modulation signal [I (in-phase) and Q (quadrature)]. I and Q will be automatically selected unless you are operating in stereo mode or not operating digital. Left and right audio content is displayed for all other audio sources.

The plot consists of a group of sequential samples to allow signal analysis. In L and R mode, the L+R portion of the signal tends to dominate the plot, resulting in the majority of samples appearing in the lower, left and upper, right quadrants. In I and Q mode, signals that are of equal frequency and 90 degrees out-of-phase result in a circular display.

Use the up or down button to maximize (if it was minimized) or minimize (if it was maximized) the panel size.

Figure 2.24: Smith Chart

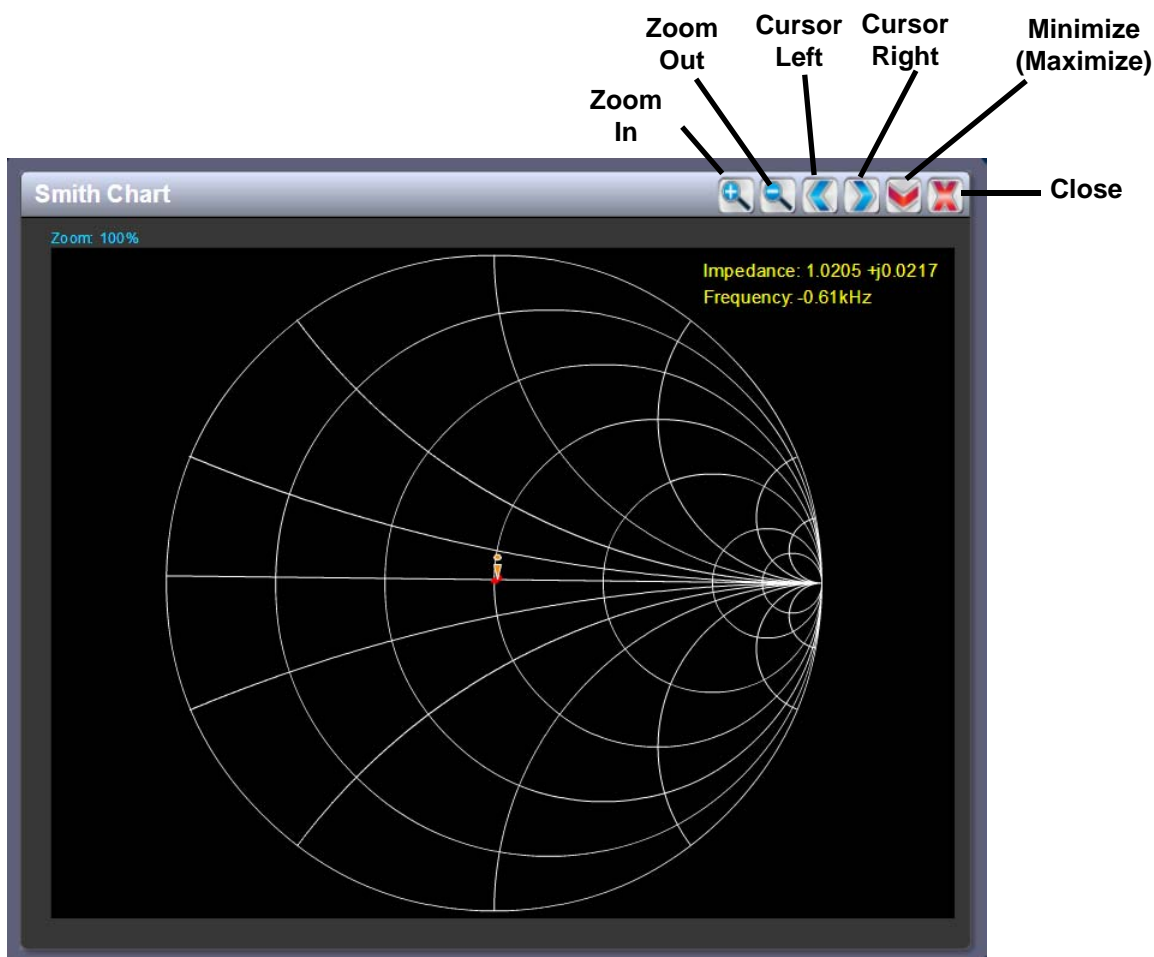

**SMITH CHART.** See [Figure 2.24](#). The Smith Chart allows you to visualize the impedance of the transmitter's load as seen at the combiner, as a function of frequency. The impedance shown on the Smith Chart is normalized to the combiner input impedance. The ideal load is therefore  $1 + j0$  ohms, which implies a perfect 50-ohm load is being applied to the output of the transmitter.

Touch on the panel to display a cursor in the nearest area on the trace showing the normalized impedance plot line. The cursor position (impedance and frequency) is noted in the upper, right-hand corner of the panel. Touch in other areas of the tool menu panel to provide a coarse adjustment of the cursor position.

Use the left and right buttons as fine adjustments.

Use the zoom in (+) and zoom out (-) buttons to size the chart between 100% and 1000%.



Use the up or down button to maximize (if it was minimized) or minimize (if it was maximized) the panel size.

**Figure 2.25: Modulation Levels**

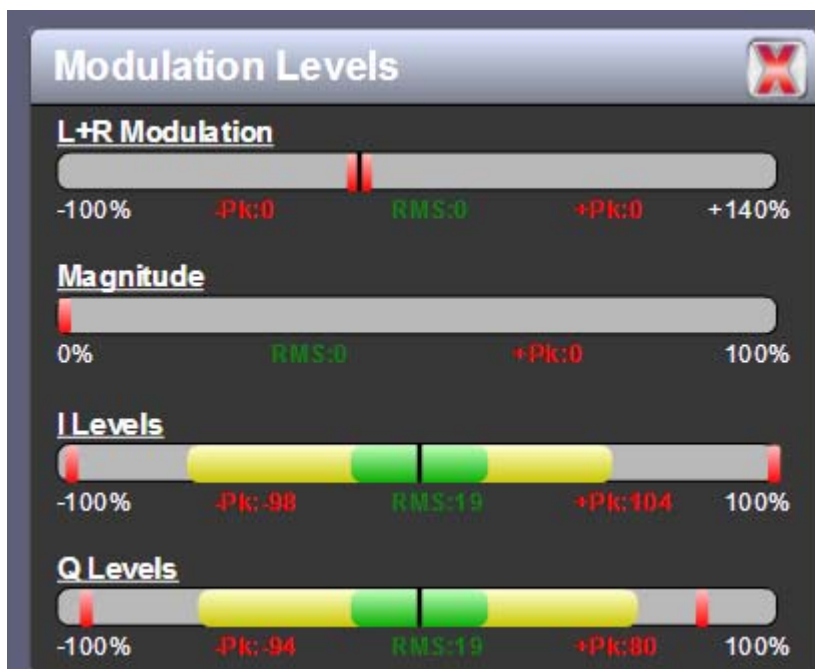

**MODULATION LEVELS.** See [Figure 2.25](#). Bar graphs display the percentage of L+R modulation, PDM (magnitude) and I/Q modulation for the transmitter. I/Q bar graphs will show levels in DRM or IBOC mode only.

The level shown in yellow represents the currently measured peak modulation level, with the RMS level shown in green. An actual RMS value is displayed below the meter).

The red markers represent the most recently recorded maximum peak level. The actual peak values are displayed in red below the meter. For L+R and I/Q modulation, both positive and negative peaks are shown.

There are no interactive tools (cursors, fine/coarse adjustments) for this display.

**Figure 2.26: Audio Inputs**

**AUDIO INPUTS.** See [Figure 2.26](#). Bar graphs display the amplitude (in dB) of the audio inputs selected in the preset.

The level shown in yellow represents the currently measured peak amplitude, with the RMS level shown in green. An actual RMS value is displayed below the meter).

The red markers represent the most recently recorded peak level. The actual peak value is displayed in red below the meter.

There are no interactive tools (cursors, fine/coarse adjustments) for this display.

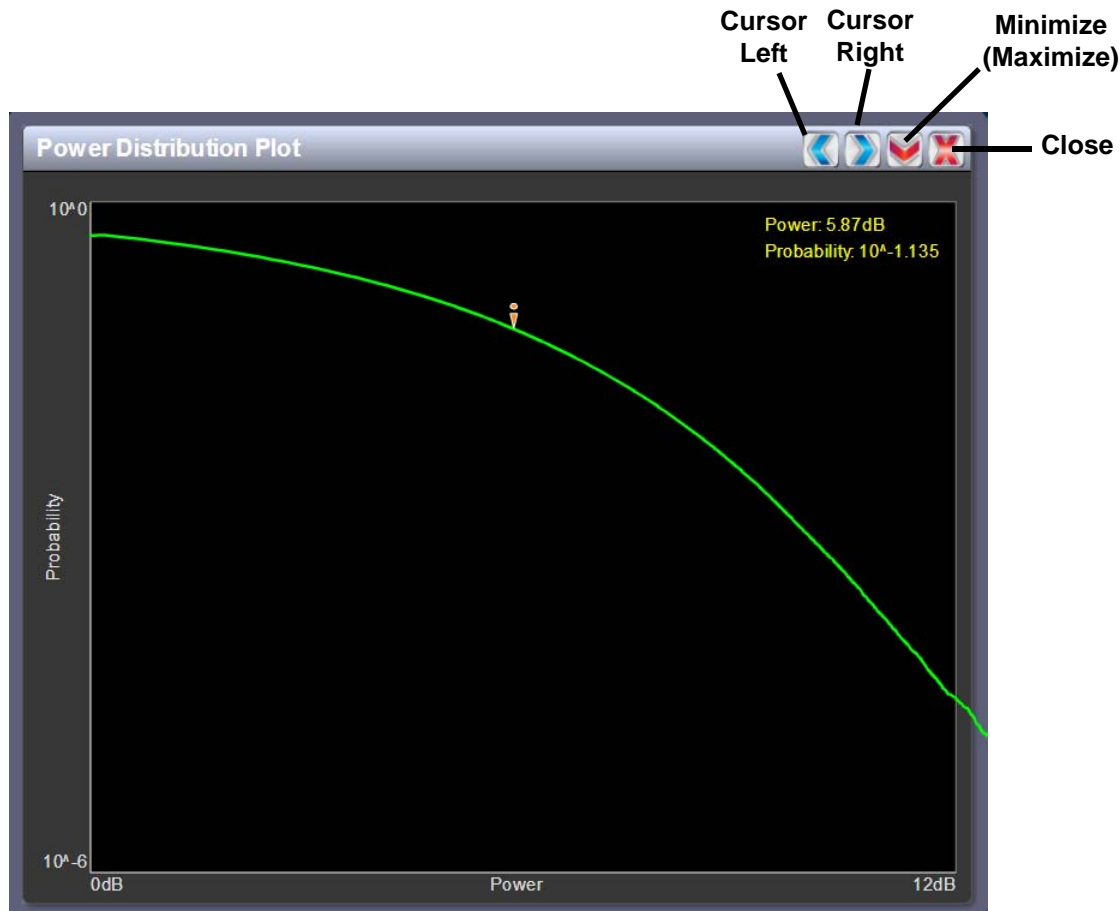
**Figure 2.27: Power Distribution Graph**

**POWER DISTRIBUTION GRAPH.** See [Figure 2.24](#). The exciter measures the relative power levels of the signal and determines the probability of exceeding a given power level, relative to the average power. The data is plotted in the **Power Distribution Graph** as a CCDF (complementary cumulative distribution function). The x-axis displays the relative power level in dB, with the reference representing the average power. The y-axis displays the probability of exceeding that power level. This graph can be used to assess the distribution of a given signal, and provides an indication of the amount of peak power capability required.

Touch on the panel to display a cursor in the approximate area on the trace. The cursor position (power gain and probability) is noted in the upper, right-hand corner of the panel. Touch in other areas of the tool menu panel to provide a coarse adjustment of the cursor position.

Use the left and right buttons to make fine adjustments.

Use the up or down button to maximize (if it was minimized) or minimize (if it was maximized) the panel size.

## METERS PAGE - VIEWING REAL-TIME METERS

The AUI displays many metered parameters on the *Home* page (right side) (Figure 2.28). This section includes the following topics:

- Describing the meter display
- "Accessing meter information", on page 2-43
- "Saving meter list", on page 2-47

Figure 2.28: Meters Page

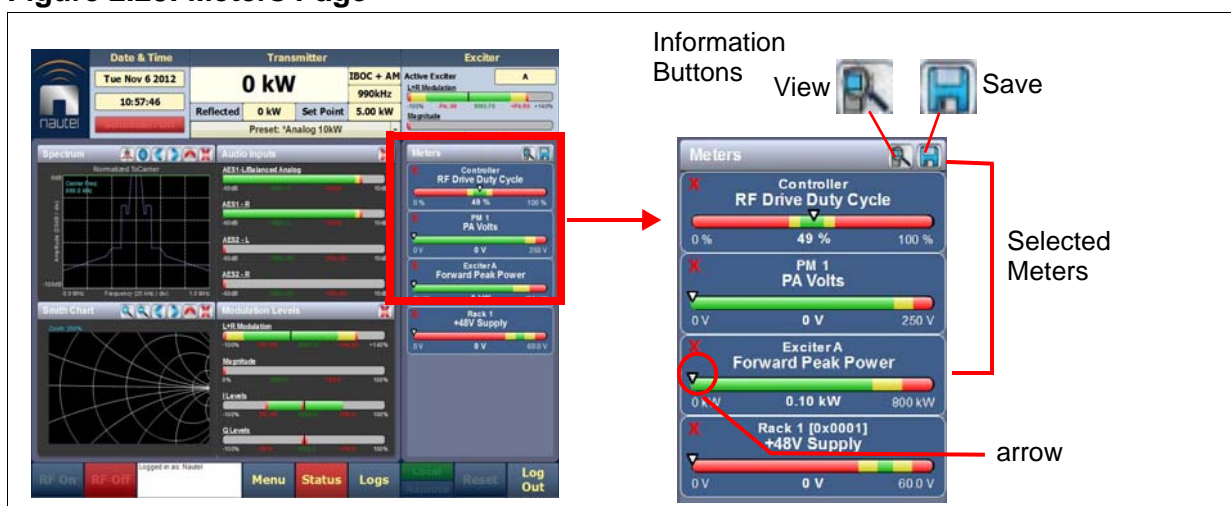

### DESCRIBING THE METER DISPLAY

The meters displayed in the AUI are active meters selected for display. Each meter is a colour-coded bar with minimum and maximum values. The current value for a meter is indicated by an arrow on the colour-coded bar, as well as a displayed value below the meter.

- A parameter value in the green section of a meter bar indicates the parameter is within the range for normal operation.
- A parameter value in the yellow section (as applicable) of a meter bar indicates the parameter is still within an operational range, but is approaching design limitations.
- A parameter value in the red section of a meter bar indicates the parameter is outside normal operating conditions.
- The number of meters that can be added to this list is limited only by the number of meters available for selection.

## ACCESSING METER INFORMATION

- To delete a meter from the **Home** page, press the **X** in the left-hand corner of the meter in the “Meters” window (right side).
- To review all the meter options, press the information button (magnifying glass) at the top of the meters panel (Figure 2.29).

**Figure 2.29: Meters List View Window**

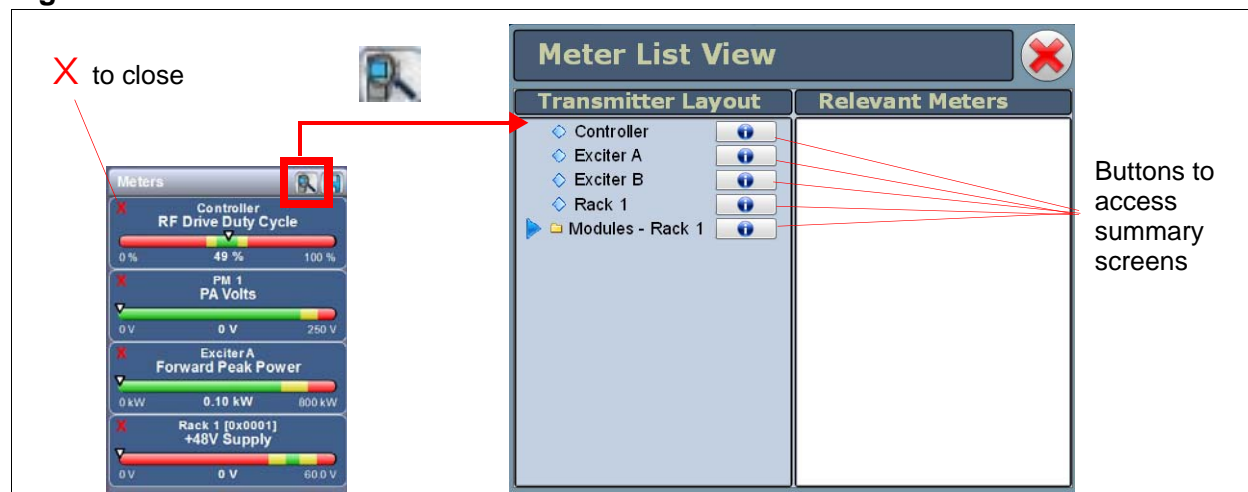

Procedure to identify meter information on a specific transmitter sub-system:

- Open the “Meters List View” window, which organizes the available meters by transmitter sub-system.
  - Controller - (Figure 2.30 on page 2-44)
  - Exciter A - (Figure 2.31 on page 2-45)
  - Exciter B - (Figure 2.31 on page 2-45)
  - Rack 1 - 4 (Multiple Racks supported, as applicable) (Figure 2.32 on page 2-45). Additionally, each Rack includes a list of PM (power module) sub-systems, representing the RF power modules in each rack. Each power module can be selected to show its meters.
  - Modules - Rack 1 - 4 (Multiple Racks supported, as applicable) (Figure 2.33 on page 2-46)

- To view the summary screen of each device type: Under “Transmitter Layout”, press the information button (i) adjacent a device type (Figure 2.30 on page 2-44, Figure 2.31 on page 2-45, Figure 2.32 on page 2-45 and Figure 2.33 on page 2-46 ). The summary screen shows all available meters in tabular format.

**NOTE:** When a meter value is updated, a blue box briefly appears around that value. Typically, updates occur every one or two seconds.

- To choose individual meters for display in the “Meters” window of the *Home* page: Select the device type name in the **Transmitter Layout** panel and select the checkbox next to the desired meters shown in the **Relevant Meters** panel. If the **Relevant Meters** panel contains more than one page of information, then use the scroll bar (right side) to find the desired meter.

**Figure 2.30: Meters - Information Display for Controller**

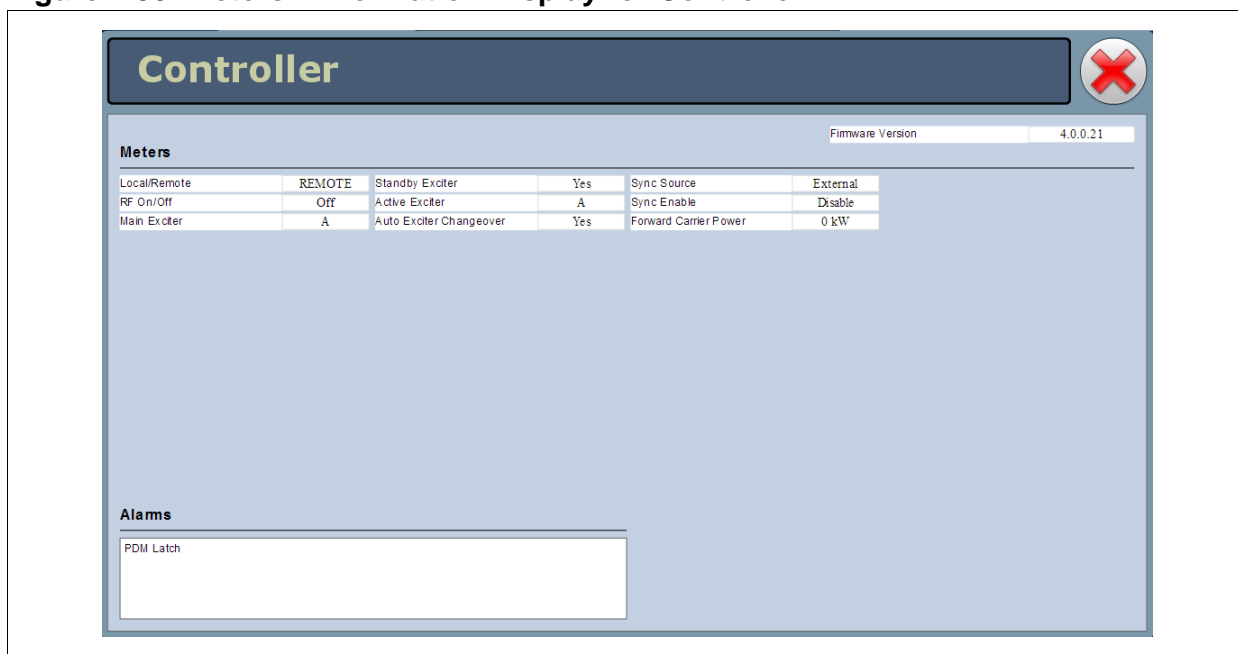

Figure 2.31: Meters - Information Display for the Exciter

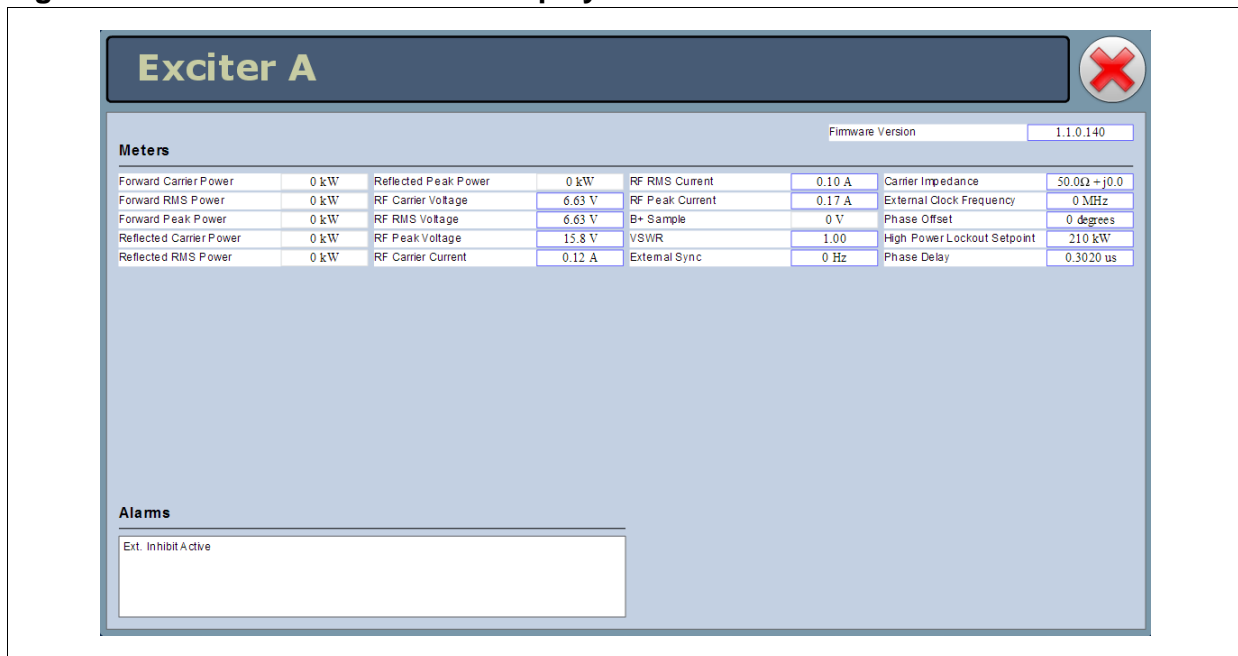
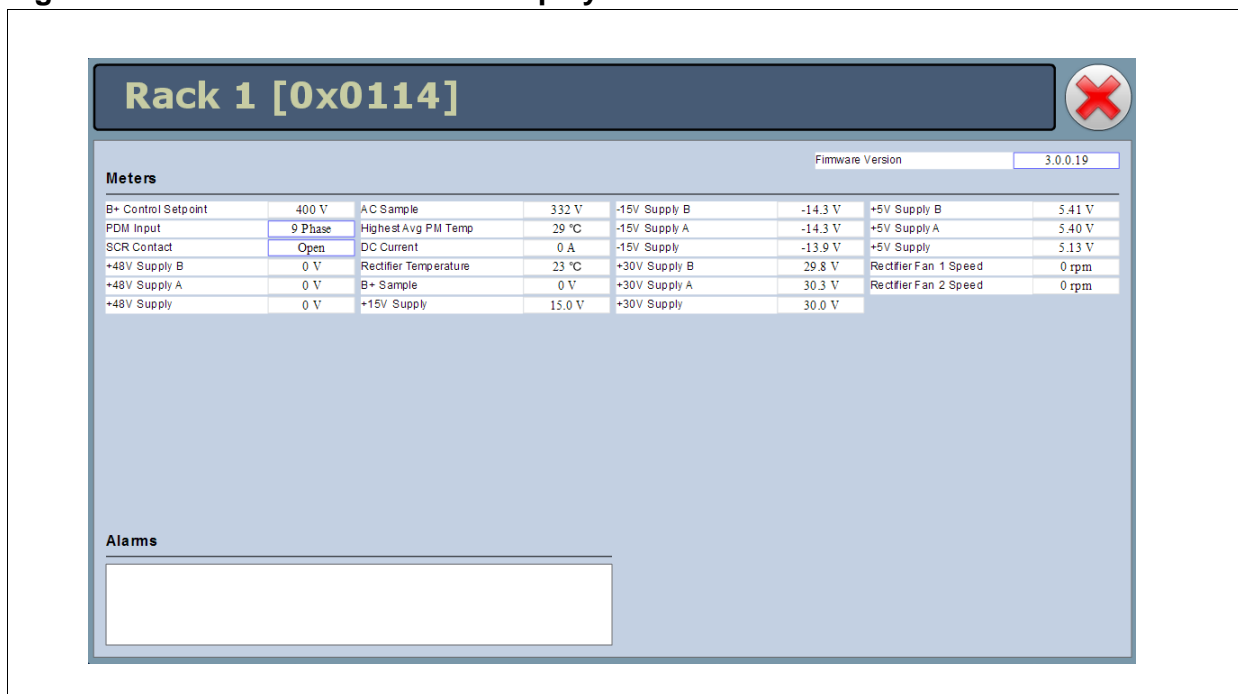
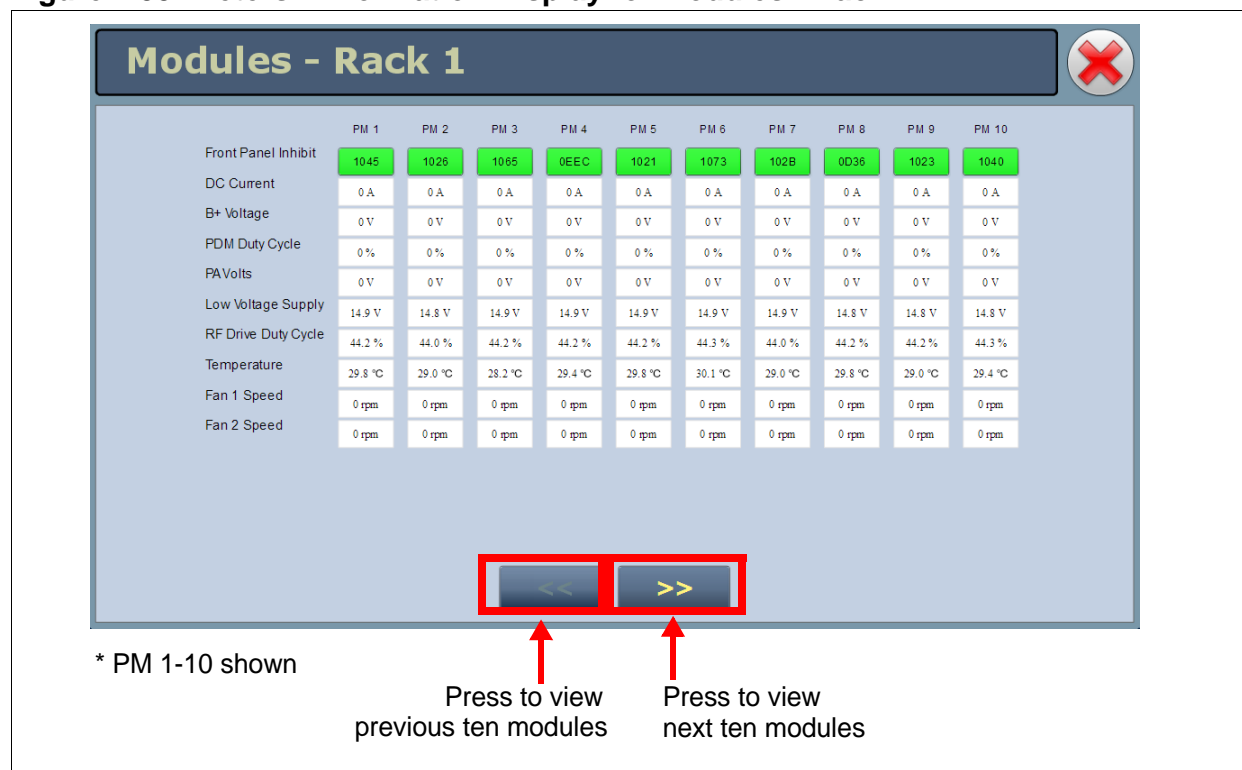

Figure 2.32: Meters - Information Display for Rack 1



**Figure 2.33: Meters - Information Display for Modules - Rack 1**



**NOTE:** Power modules are numbered (e.g., PM1, PM2, etc.) in the order they are plugged in, which is not necessarily the same as their physical location in the transmitter. To match a meter or an alarm with a specific power module, match the hexadecimal serial address (see [Figure 2.33](#), shown within the **Front Panel Inhibit** button) with that shown on the label on the front of the power module.

On the modules summary screen ([Figure 2.33](#)), meters for only ten power modules are shown on a page. For transmitters with more than ten power modules, use the left and right arrow buttons on the bottom of the page to cycle through the groups of ten power modules.

Individual power modules can be directly inhibited by pressing their **Front Panel Inhibit** button.



## SAVING METER LIST

**NOTE:** Meter lists are associated with user accounts. Lists saved in this screen are only displayed in the current user account. Setting a list as default will define the meters that will appear when logging into the current account (or after an ac power interruption in the local AUI if this is the default user account).

To save meter specifics for display on the **Home** page:

1. Open the **Meter List Save** window from the **Home** page using the floppy disk button (Figure 2.34).
  - Press **Save As** to save the currently displayed meters. Enter a name in the **Layout Name** entry box and press **OK**.
  - Press **Delete** to discard the selected meter list.
  - Press **Set Default** to set the selected meter list as the default for the current user account.
  - Press **Save** to overwrite the selected meter list with the currently displayed meters.
  - Press **Load** to display the meters saved under the currently selected meter list in the **Meters** panel on the right-hand side of the **Home** page.

**Figure 2.34: Meters List Save Window**

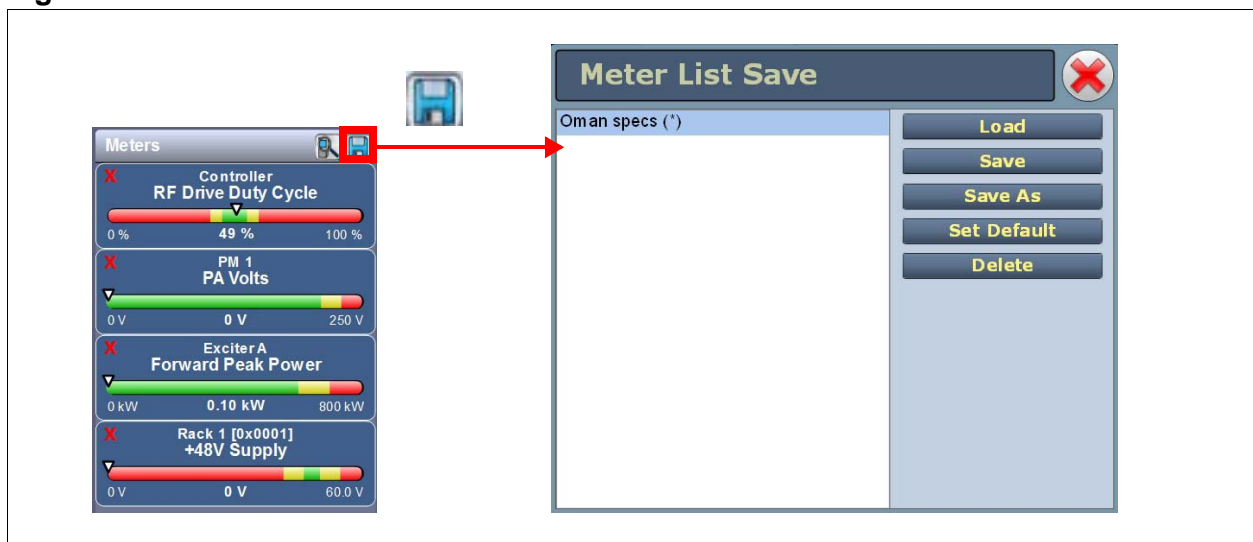

## PRESETS - EDITING OPERATIONAL SETTINGS

The **Presets** page (see [Figure 2.35](#)) allows you to view operational data (power level, frequency, mode, program input characteristics), plus create and control preset settings. You can create up to 62 presets or edit existing presets.

To view the **Presets** page, select **Presets** in the **Menu** page.

This section includes the following topics:

- "Activating Presets", on page 2-49
- "Editing or Creating Presets", on page 2-49
- "Loading Presets", on page 2-50
- "Changing preset schedules", on page 2-50
- "Understanding the preset tabs", on page 2-51
- "Preset examples - IBOC preset", on page 2-55
- "Preset examples - Analog preset", on page 2-55
- "Preset examples - IBOC preset with analog backup", on page 2-56

**Figure 2.35: Presets Page - General Tab**

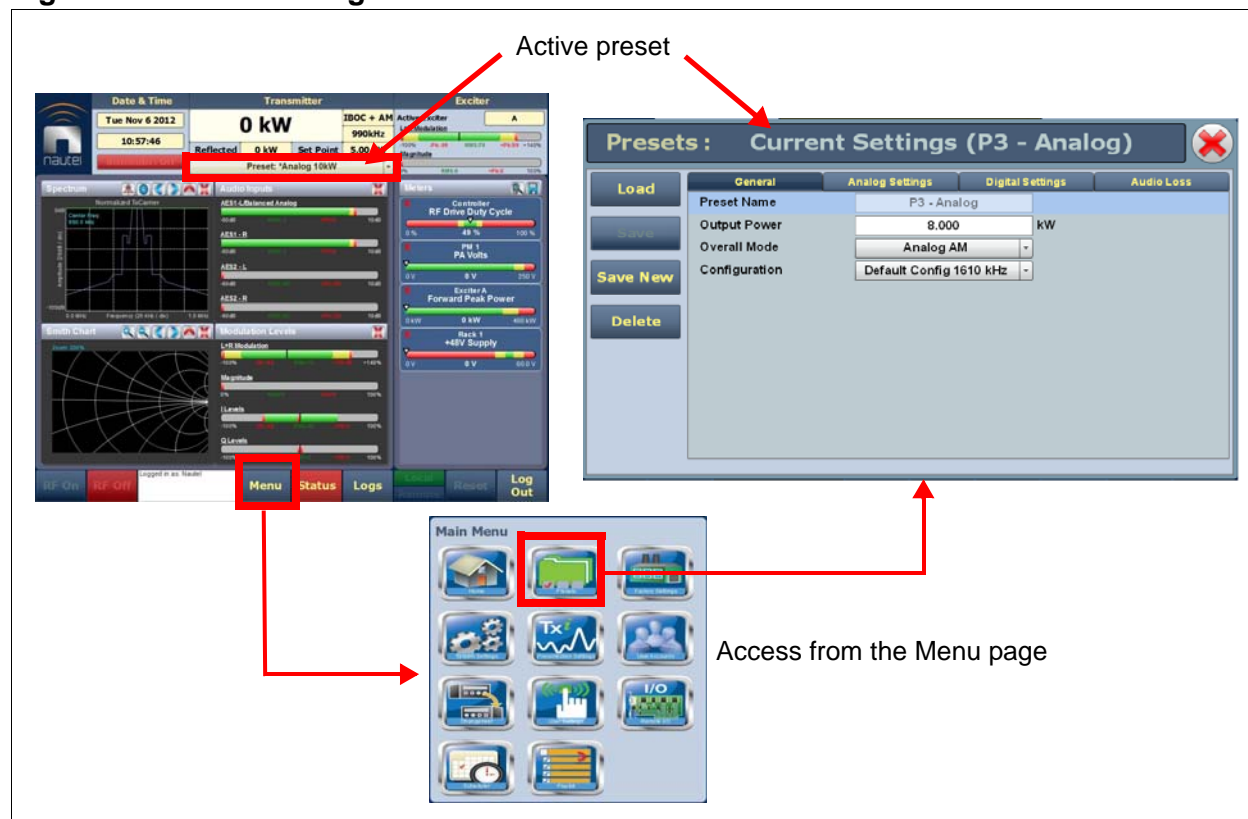

## ACTIVATING PRESETS

In the **Transmitter** block in the AUI's top banner, click the bar that contains the active preset name and the drop-down arrow (see [Figure 2.36](#)). The **Activate Preset** window will appear, which contains a list of all preset options. Click and highlight the desired preset and click the **Activate** button to enable the preset as the transmitter's active preset. Click the **Cancel** button to close this window.

**Figure 2.36: Activate a Preset**

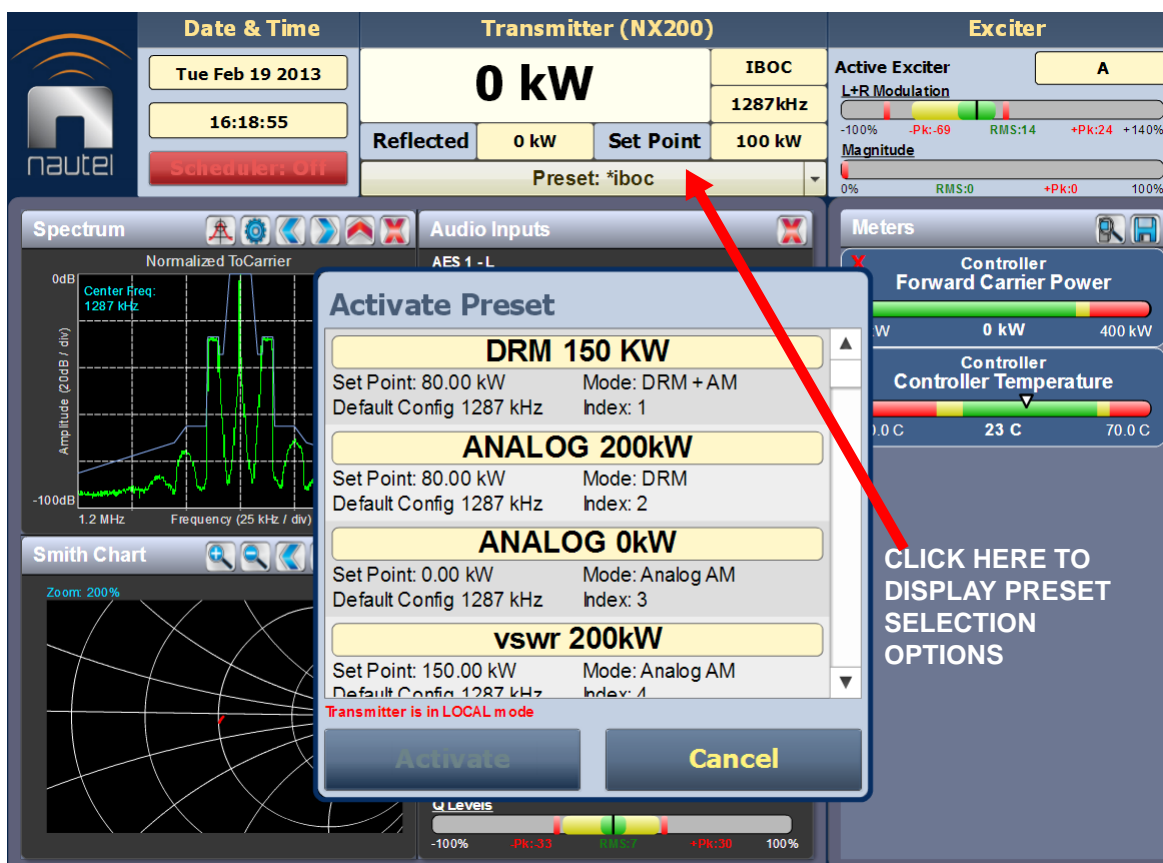

## EDITING OR CREATING PRESETS

When the **Presets** page (see [Figure 2.37](#) on page 2-54, [Figure 2.38](#) on page 2-54 and [Figure 2.39](#) on page 2-54) is opened from the menu, the **Current Settings** of the transmitter are displayed. They define the current operational state of the transmitter. **Current Settings** can be edited and then immediately activated by pressing the **Save** button.

To edit a saved preset, you must load that preset from the **Presets** page (see "[Loading Presets](#)", on page 2-53). If the edited preset was active before it was edited, saving the preset will update the preset, but the **Current Settings** will not change. To update the operation of the transmitter, re-activate the preset through the top banner (see "[Activating Presets](#)", on page 2-49).

In the top banner, an asterisk (\*) appears next to the preset name when the **Current Settings** have changed since the last preset was loaded. **Current Settings** are not saved through an ac power cycle; when the transmitter recovers from an ac power loss, it loads the preset that was last activated.

On the **Presets** page, an asterisk (\*) appears next to the preset name in the header when there are unsaved changes to the preset.

When changes are complete, click the **Save** button and then click the **Save Preset** window's **Save** button to enable the changes. If you are creating a new preset, you can also enter a new name (e.g., Preset 4 - IBOC) in the preset window before clicking the **Save** or **Save New** button.

Parameters that can be edited are discussed in detail in ["Understanding the preset tabs"](#), on page 2-51.

To remove a preset, select it and press the **Delete** button.

To ignore any changes, press **Cancel** to return to the **Presets** page.

**NOTE:** See ["Preset examples - IBOC preset"](#), on page 2-55, ["Preset examples - Analog preset"](#), on page 2-55, ["Preset examples - IBOC preset with analog backup"](#), on page 2-56 and ["Preset examples - DRM preset"](#), on page 2-56 for sample presets for different transmission modes.

## LOADING PRESETS

When you enter the **Presets** page, the **Current Settings** of the transmitter are displayed. See ["Editing or Creating Presets"](#), on page 2-49 for more information on **Current Settings**. If you do not wish to change the current operational state of the transmitter, use the **Load** button on the left side of the **Presets** page to display a window containing a list of other presets. Select the desired preset and click the **Load** button to view or enable editing of the preset. Click the **Cancel** button to close this window.

## CHANGING PRESET SCHEDULES

You can program a preset schedule for the transmitter, using the **Scheduler** page (see ["Preset Scheduler"](#), on page 2-61).

---

## UNDERSTANDING THE PRESET TABS

The **Presets** page consists of tabs across the top with functions on the left-side and parameters displayed in the center and right-side of the window. A separate display appears for each of the following tabs:

### General

([Figure 2.35 on page 2-48](#))

- **Preset Name** - this identifies the current preset. You must load a preset to directly edit this field (see "[Loading Presets](#)", on page 2-50).
- **Output Power** - set the output power level (in kW)
- **Overall Mode** - set the overall transmission mode. Options are:
  - **Analog AM**: transmits a carrier, amplitude modulated with audio. Audio settings are selected in the Analog Settings tab.
  - **DRM**: transmits a DRM OFDM signal using the I/Q stream from a DRM modulator connected to the desired AES input. Modulation settings are selected in the Digital Settings tab.
  - **DRM+AM**: Also known as simulcast, transmits a carrier, amplitude modulated with audio and a DRM OFDM signal in either an upper or lower channel. AM settings are selected in the Analog Settings tab and DRM settings are selected in the Digital Settings tab. In this case, if balanced analog audio input is used for AM modulation, AES2 input (Digital AES input) must be used for I/Q stream from the DRM modulator. If AES is used for AM modulation, either AES input may be used for either input (AM modulation and DRM I/Q stream).
  - **IBOC**: transmits an AM IBOC standard signal (carrier, amplitude modulated with audio and upper and lower sidebands of OFDM IBOC carriers). Requires an Exgine to be installed in the transmitter that is receiving modulation information from and Exporter. Both the AM signal and IBOC carriers are received in the I/Q stream from the Exgine. Modulation settings are selected in the Digital Settings tab and through the User Settings > Exgine Settings page.
  - **IBOC+AM**: The transmitted signal in this mode is identical to IBOC mode. In this mode, the information for the OFDM carriers is received from the Exgine and the AM information is received through an audio input in the transmitter. In this mode, the AM audio signal cannot be connected to AES2; it must be connected to Bal Anlg Audio or AES1. AM settings are selected in the Analog Settings tab. IBOC carrier modulation settings are selected in the Digital Settings tab and in the User Settings > Exgine Settings page.
- **Configuration** - select the pre-correction configuration (see "[Precorrection Settings page](#)", on page 2-97)

---

**NOTE:** Available settings on the **Analog Settings** and **Digital Settings** tabs are shown/hidden based on the **Overall Mode** setting. Not all settings are available in all modes.

### Analog Settings

([Figure 2.37 on page 2-54](#))

- **AM Source** - select the audio source for the AM signal. Options are:
  - Balanced Analog (connector J12 on A11A1)
  - AES1 (connector J11 on A11A1)
  - AES2 (connector J10 on A11A1)
  - Audio Player/AES1: Requires installed USB sound card option. Plays audio player playlist through single-board computer USB port; This USB port must be connected to the USB sound card, the output of which should be connected to the AES1 input.
  - Audio Player/AES2: Same as above for AES2 input.
- **Format** - Options are:
  - AM Carrier: transmits carrier only; ignores audio inputs.
  - Mono L+R: adds L+R channels on AES signal.
  - Mono L: transmits L channel of AES signal or Bal Analog.
  - Mono R: transmits R channel of AES signal.
  - Stereo C-QUAM: uses amplitude and phase modulation over AES, to transmit a stereo AM signal.
- **Filter Type** - selects a filter to be applied to the input audio signal. Options are:
  - None: no filter is applied (default).
  - Brick Wall: applies a low pass filter with a very sharp cutoff and a 6 dB bandwidth defined by the Filter Bandwidth setting (between 1 kHz and 10 kHz).
  - Minimum Overshoot: applies a Gaussian low pass filter with a very gentle rolloff and a 3 dB bandwidth of 5.13 kHz. Used to minimize ringing of the modulator filter with extremely high rate of change input signals (e.g., square waves). Typically used only for testing purposes.
- **Preemphasis** - applies a NRSC-1 pre-emphasis curve to the input audio signal. Default is OFF.
- **Dynamic Carrier Control** - selects the DCC mode, as applicable. Options are None, AMC, EAMC, DAM or DAM Full. Default is None. When a DCC mode is selected a Max DCC Compression level can also be entered. See "[Selecting the DCC mode](#)", on [page 2-57](#) for more information on each mode.
- **AMSS** - Amplitude Modulation Signalling System. Allows low-bit rate data to be transmitted with the Analog AM signal. Contact Nautel for assistance with using AMSS. Default is OFF.

- AES Input Level - Defines the AES input level (in dBFS) that will result in 100% modulation depth. Set between -30 dBFS and 0 dBFS, according to the input signal level.
- Balanced Analog Input Level - Defines the Bal Analog input level (in dBm) that will result in 100% modulation depth. Set between -20 dBm and +12 dBm, according to the input signal level.

### Digital Settings

(Figure 2.38 on page 2-54)

- Data Source - Select the source for the OFDM (digital) signal (AES1 or AES2).
- DRM Bandwidth - Select the bandwidth of the DRM signal to be transmitted. This setting only sets the parameters of the mask shown on the spectrum analyzer. Transmitted signal bandwidth is set at the I/Q source (DRM modulator). Select 4.5 kHz, 5 kHz, 9 kHz, 10 kHz, 18 kHz or 20 kHz.
- Frequency Offset - In AM+DRM mode, sets the frequency offset between the AM signal and the DRM carriers. Set between -20 kHz and +20 kHz.
- Power Differential - In AM+DRM mode, sets the difference between the AM carrier power and the RMS power of the DRM carriers. The level is approximately based on the input signal to the exciter and may require adjustment to obtain the exact level. Set between 0 dB and 40 dB.
- Digital AES input Level - Defines the full-scale AES input level (in dBFS) for the I/Q stream. Set between -30 dBFS and 0 dBFS
- IBOC BW - In IBOC mode, sets the bandwidth for the IBOC signal. Select 5 kHz or 8 kHz.

### Audio Loss

(Figure 2.39 on page 2-54)

- Mod Loss Timeout - Determine if an action should be taken on the loss of a modulating signal. Select Yes or No. Default is No. If Yes, the following sub-fields appear:
  - Action: select the action to take on the loss of a modulating signal. Select None (no resulting action), Inhibit (inhibits the RF output, fans and B+ voltage until the audio returns) or Change Preset (changes the active preset).
  - Mod Loss Preset: displayed only if Action is set to Change Preset. Select the preset from the drop-down list that will activate upon the loss of a modulating signal.
  - Timeout Minutes: sets the delay, in minutes, between audio loss detection and the resulting action. Enter a value between 0 and 255 minutes.
  - Timeout Seconds - sets the delay, in seconds, between audio loss detection and the resulting action. Enter a value between 0 and 59.9 seconds
  - Threshold - sets the threshold for audio loss detection. Enter a value between 0 and 100%

Figure 2.37: Presets - Analog Settings

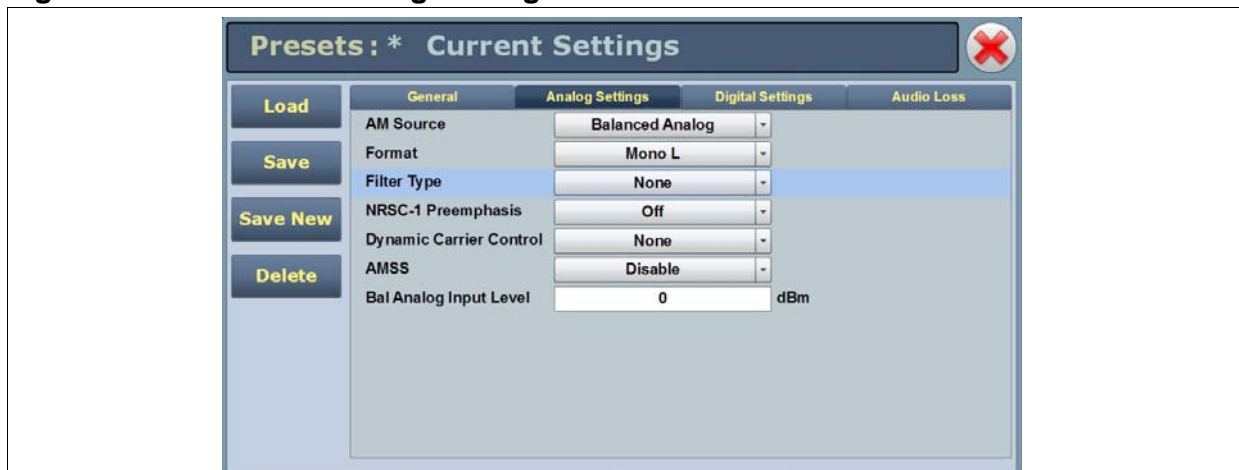

Figure 2.38: Presets - Digital Settings

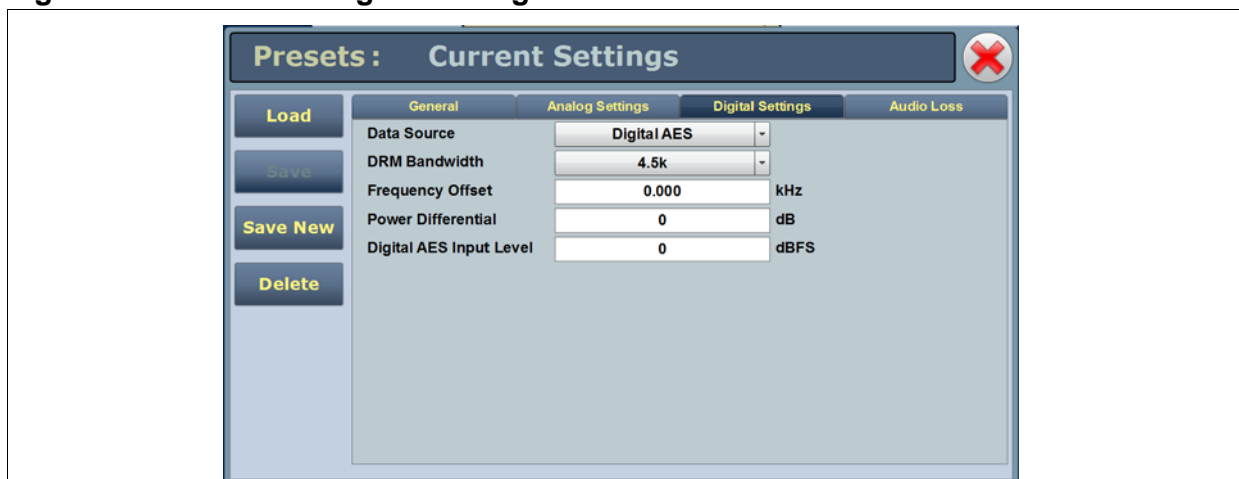
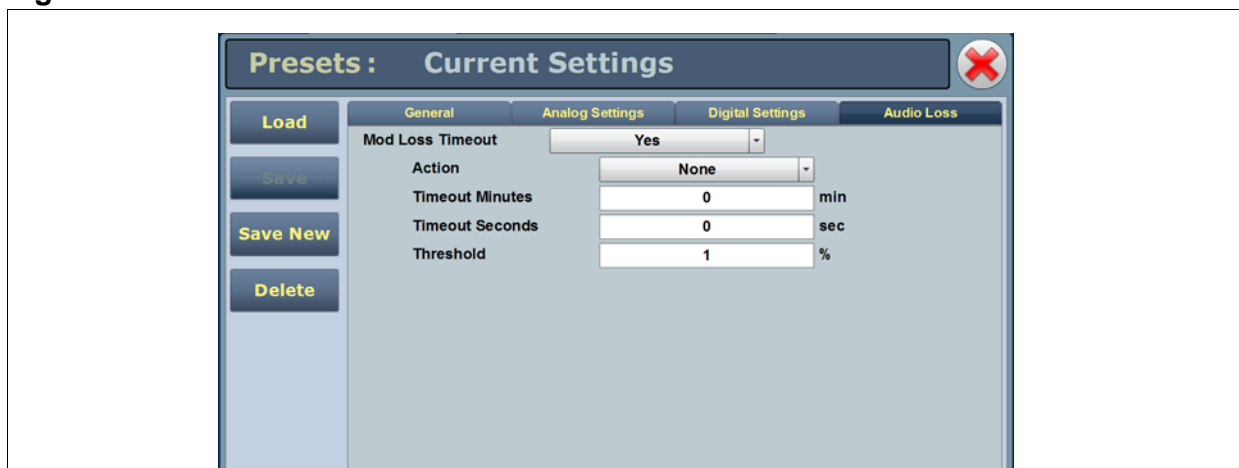

Figure 2.39: Presets Tabs - Audio Loss





## PRESET EXAMPLES - IBOC PRESET

The following examples shows you how to set presets for the IBOC applications with typical values:

1. Enter **Output Power** field with desired power level.
2. Set **Overall Mode** to **IBOC**.
3. Under **Digital Settings**, set **Bandwidth** to 5 kHz.

## PRESET EXAMPLES - ANALOG PRESET

1. Enter **Output Power** field with desired power level.
2. Set **Overall Mode** to Analog AM.
3. Under **Analog Settings**, set **AM Source** as required (typically Analog AES).
4. Under **Analog Settings**, set **Format** as required (typically Mono L + R).
5. Under **Analog Settings**, enter **Bandwidth** field as required.
6. Under **Analog Settings**, set **Preemphasis** to **Off** (typically).
7. Under **Analog Settings**, set **Dynamic Carrier Control** to **None** (typically).

## PRESET EXAMPLES - IBOC PRESET WITH ANALOG BACKUP

1. Set two presets similar to the two previous examples.
2. Under **Audio Loss**, set **Mod Loss Timeout** to **Yes**. Several other selectable fields will appear.
3. In the **Action** field, select **Change Preset** from the drop-down list. The **Mod Loss Preset** field will appear.
4. In the **Mod Loss Preset** field, select the desired preset from the drop-down list. This is the preset that will activate upon a modulation loss.
5. Set the remaining mod loss timeout fields. See "[Audio Loss](#)", on page 2-53.
6. Save the preset with the desired name (new or existing). See "[Editing or Creating Presets](#)", on page 2-49.

## PRESET EXAMPLES - DRM PRESET

1. Enter **Output Power** field with desired power level.
2. Set **Overall Mode** to **DRM**.
3. Under **Digital Settings**, set **Data Source** as required (**AES 1** or **AES 2**).
4. Under **Digital Settings**, set **DRM Bandwidth** as required.
5. Under **Digital Settings**, set the **AES Input Level** for the selected data source to the appropriate level for the DRM modulator.

## SELECTING THE DCC MODE

The NX50 is capable of several DCC modes (see "Editing or Creating Presets", on page 2-49), each with varying performance in terms of energy savings and effects on the reproduced signal. The selectable options are:

- AMC (see Figure 2.40)
- EAMC (see Figure 2.41 on page 2-58)
- DAM (basic) (see Figure 2.42 on page 2-58)
- DAM Full (see Figure 2.43 on page 2-59)
- DCC1 (see Figure 2.44 on page 2-59)

Once a DCC curve has been selected, the desired **Max DCC Compression** level can be entered. This setting defines the maximum reduction in carrier (or carrier and sideband) power for a given curve. Standard compression settings are as follows:

- AMC and EAMC modes: 3 dB
- DAM, Full DAM and DCC1 modes: 4.44 dB

**Figure 2.40: AMC**

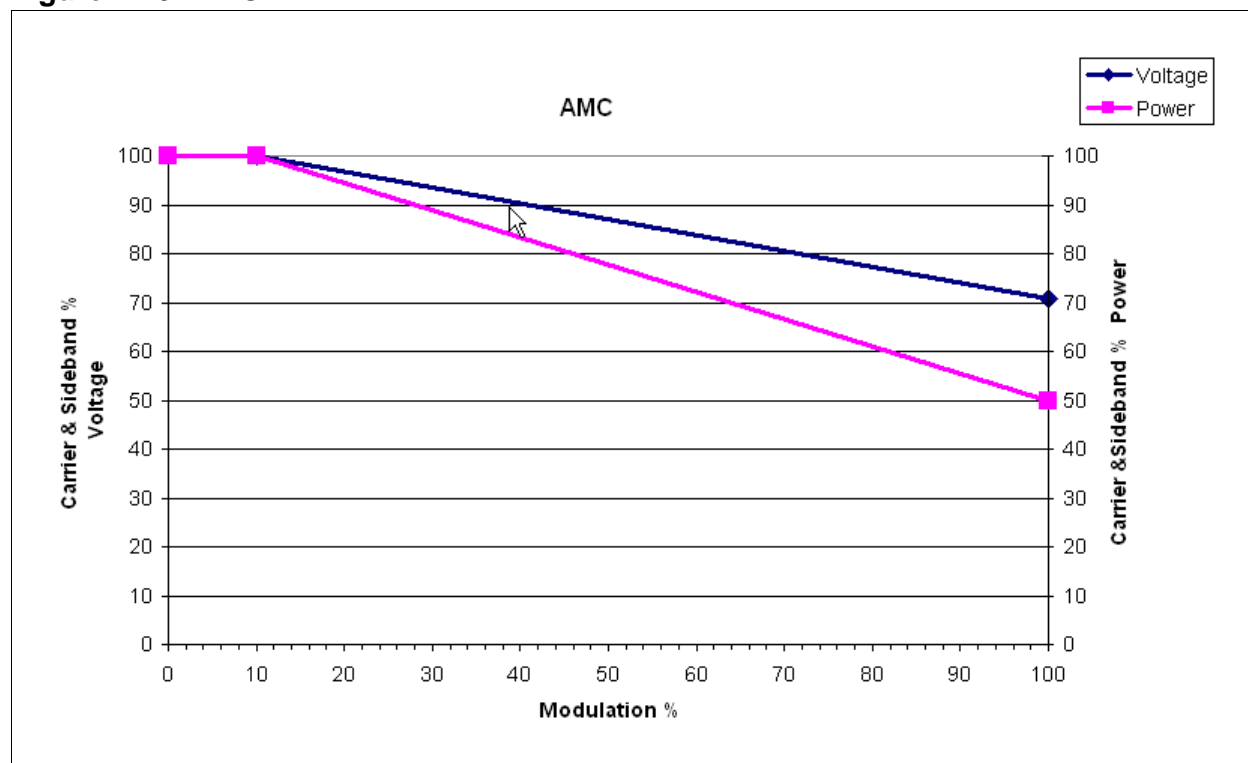

Figure 2.41: EAMC

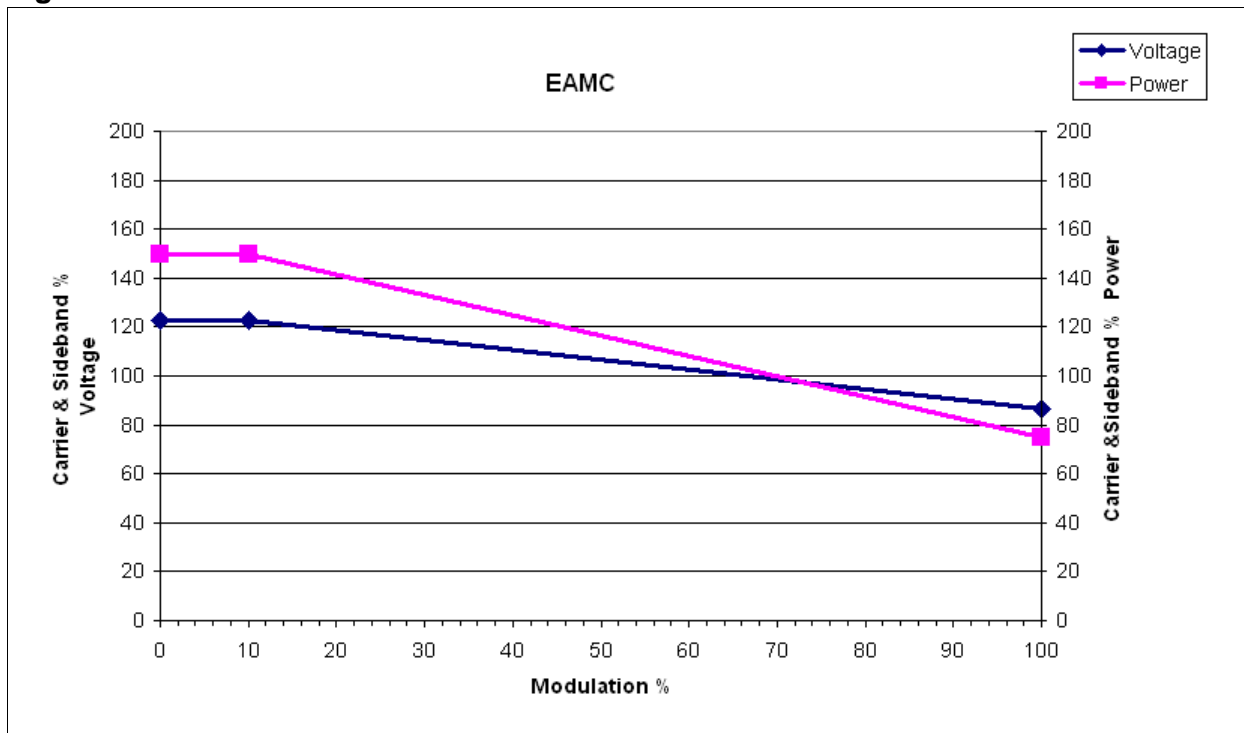

Figure 2.42: Basic DAM

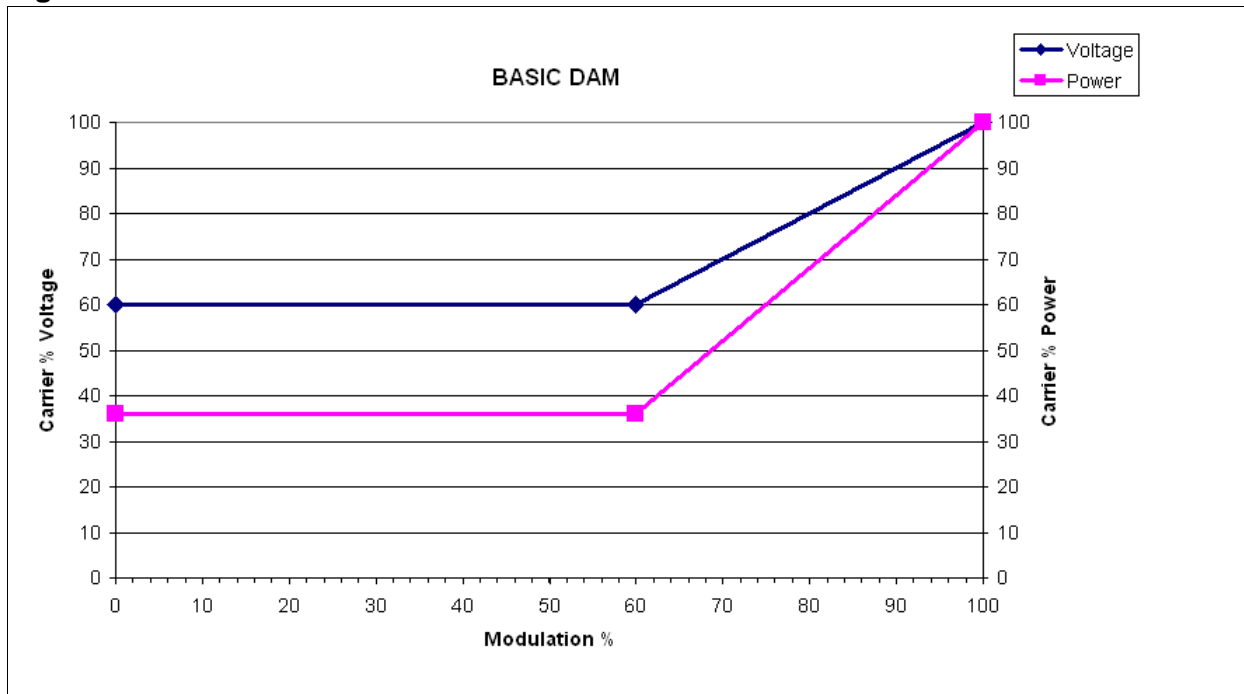

Figure 2.43: Full DAM

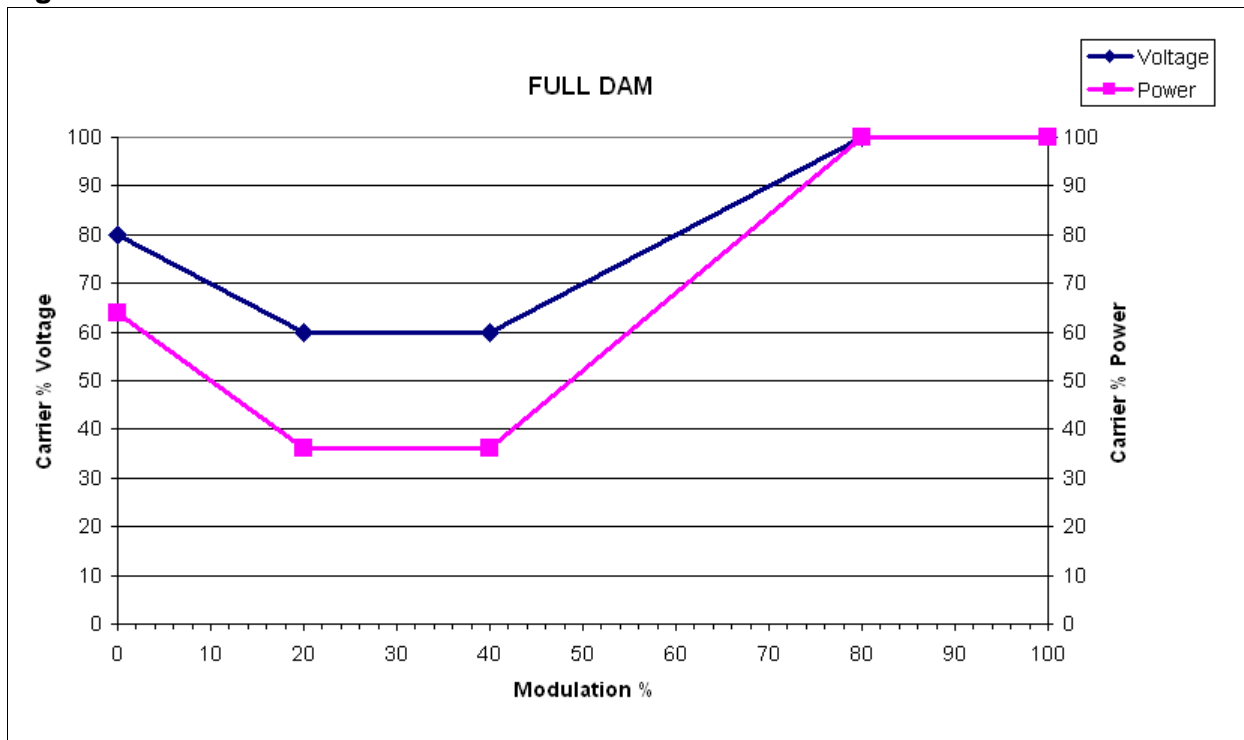
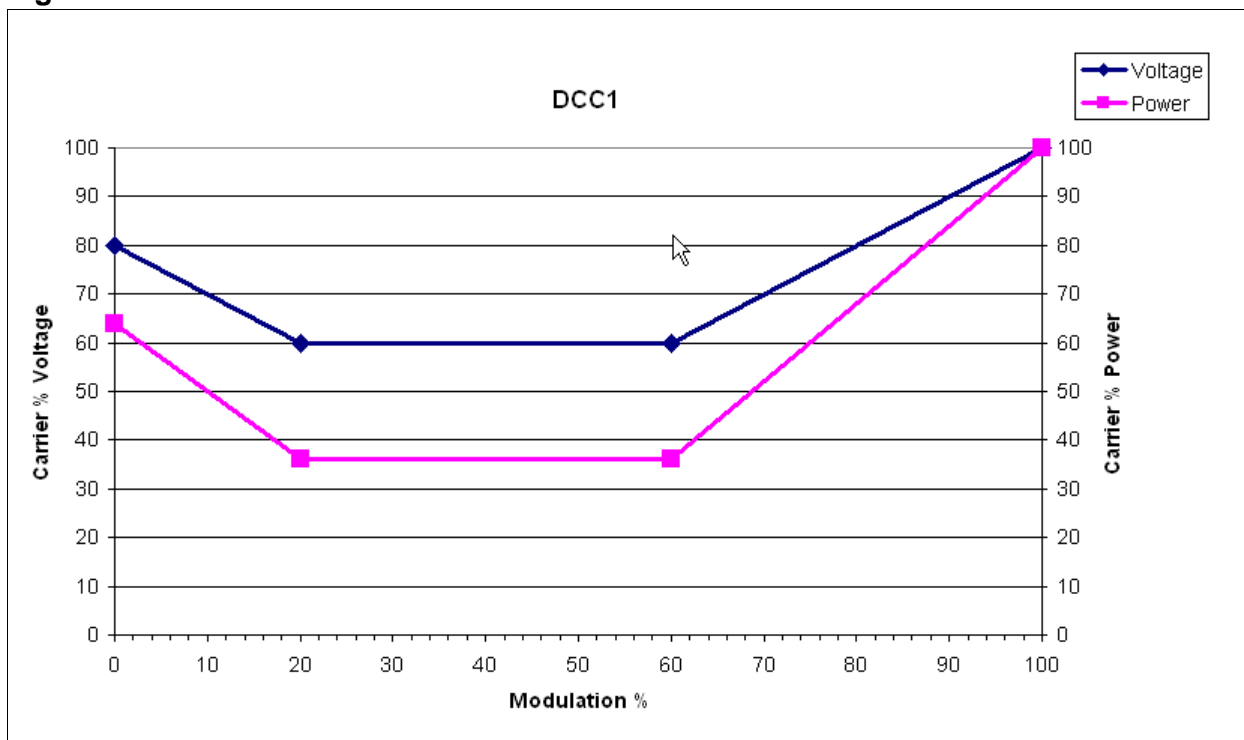

Figure 2.44: DCC1



**GUIDELINES FOR SELECTING THE DCC MODE:**

Observe the following guidelines when selecting the DCC mode for your application.

AMC mode (see [Figure 2.40 on page 2-57](#)) should work well for most broadcasters and is generally recommended if you have an IBOC transmission. It has several advantages over the other modes:

- It tends to save the most power when used with a heavily processed audio signal and asymmetrical modulation.
- It does not affect the modulation depths of the received signal, so the station's sound should not change.
- It performs the reduction in power in such a way that it tends not be masked by the audio.

If AMC is not being used, consider DAM mode as a second choice, although the power savings will be significantly less. If the station is operating with less audio processing, or has more silent periods, the DAM algorithms will tend to save more power. However, the basic DAM characteristic will impact the audio quality of the station. In IBOC mode, DAM will significantly reduce the audio quality of the station as it will increase the impact of the IBOC on the analog. It may also make it more difficult for the transmitter to meet the spectral mask, by making the transmitter operate at a much higher modulation depth and effectively increasing the level of the digital carriers relative to the analog.

## PRESET SCHEDULER

If the scheduler is enabled (see "Enabling the Scheduler", on page 2-63), you can program a preset schedule for the transmitter. Use the **Scheduler** page (see Figure 2.45) to set the dates and times at which presets take effect. You can define up to 144 scheduler rules. To view the **Scheduler** page, select **Scheduler** from the **Menu** page options.

Figure 2.45: Scheduler page



The left-hand side of the **Scheduler** page displays a monthly calendar (e.g., February 2013). Use the << and >> buttons to navigate between months. Use the < and > buttons to navigate to the beginning and the end of the schedule.

The right-hand side of the **Scheduler** page contains a **Rules** section and a **Daily Events** section. All programmed rules are displayed in the **Rules** section. Clicking on a specific date in the monthly calendar displays the rules, as applicable for that day, in the **Daily Events** section.

## EDITING SCHEDULER RULES

When you click in the **Rules** list, you have the option to edit or delete an existing rule, or to create a new rule (up to a maximum of 144 rules). Click the **New** or **Edit** button to display the **Rule Explorer** window (see [Figure 2.46](#)). Click **Delete** to remove a rule from the list.

**Figure 2.46: Rule Explorer window**

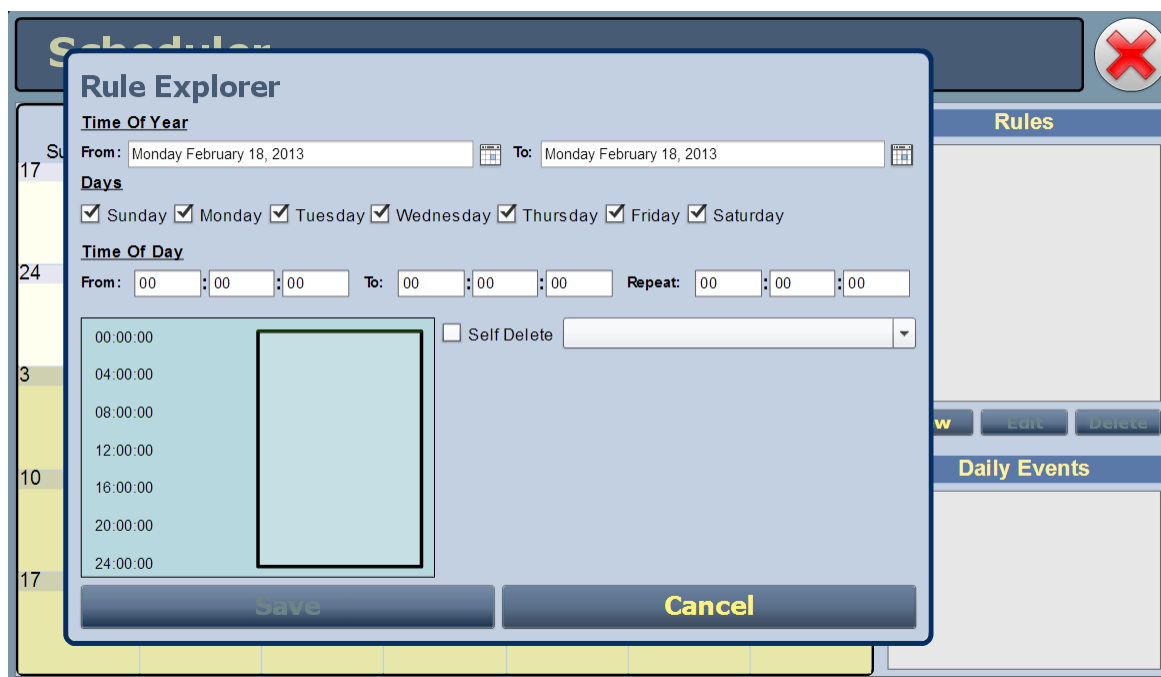

Use the **Rule Explorer** window as follows:

- In the **Time of Year** section, set the start (From:) and end (To:) dates for the rule. Start to end dates must be less than one year apart.
- In the **Days** section, select the days of the week on which the rule will apply.
- In the **Time of Day** section, set the start (From:) and end (To:) times (hours, minutes and seconds) for the rule. Use the **Repeat:** field to establish a repeating cycle for the rule (e.g., every 24 hours).
- Use the drop-down menu to select the preset for the rule. The preset's power and mode are displayed below the preset.
- Unless you edit other rules first, you cannot select a date that occurs before the start of the previous rule or after the start of the following rule.
- Click the **Save** button to store the rule in the scheduler or the **Cancel** button to return to the **Scheduler** page.



## ENABLING THE SCHEDULER

You can enable or disable the scheduler by clicking the **Scheduler** button in the **Date & Time** section (see [Figure 2.47](#)).

**Figure 2.47: Enabling/disabling the scheduler**

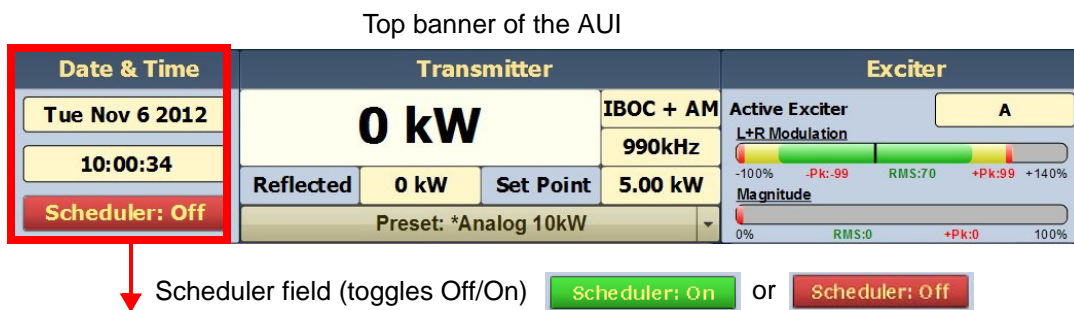

When **Scheduler: ON** appears in green, the transmitter will follow the **Scheduler** settings.

When **Scheduler: OFF** appears in red, the transmitter will stop following the schedule and the active preset will be the preset that was operating when the scheduler was disabled.

## STATUS - VIEWING TRANSMITTER STATUS

You can view the operational status of the transmitter using the **Status** Page (see [Figure 2.48](#)). This page shows current active alarms to aid in fault diagnosis.

This section includes the following topics:

- ["Viewing alarm details"](#), on page 2-65
- ["Status button colour indications"](#), on page 2-65
- ["Resetting alarms"](#), on page 2-65

**Figure 2.48: Transmitter Status Page**

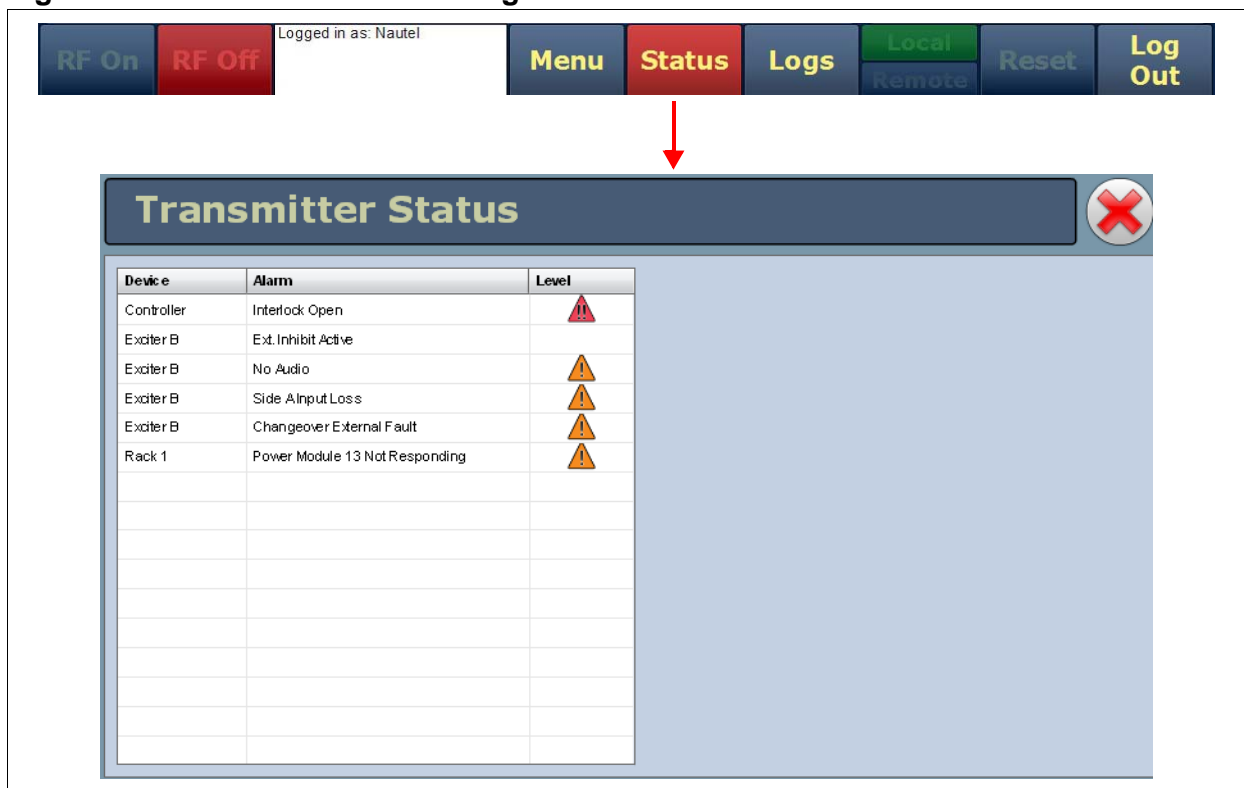



## VIEWING ALARM DETAILS

The **Transmitter Status** page displays a table that lists the active alarm details under the following columns:

- **Device** - identifies the alarms by their originating device (e.g., Controller, Exciter A, etc.)
- **Alarm** - identifies the type of alarm (alarm name).
- **Level** - identifies the severity level of the alarm

 = low (RF output not affected)

 = medium (RF output may be reduced)

 = high (RF output may be inhibited)

## STATUS BUTTON COLOUR INDICATIONS

- When the **Status** button is red, one or more active alarms are indicating that the transmitter may be in an ‘off-air’ state.
- When the **Status** button is yellow, one or more active alarms are indicating that the transmitter is still ‘on-air’, but may be at reduced power.
- When the **Status** button is green, no alarms are being reported and the transmitter is operating normally.

## RESETTING ALARMS

When an alarm is present, use the **Reset** button (Figure 2.49), at the bottom of any AUI screen, to clear any latching alarms that are holding the transmitter in an “off-air” state. If the offending alarm has cleared, then the transmitter should resume operation.

**Figure 2.49: Logs - Reset**

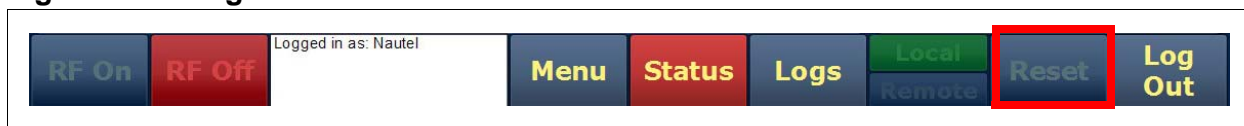

## USER ACCOUNTS

The **User Accounts** page allows you to set up user accounts and assign different levels of access to the transmitter control operations (see [Figure 2.50](#)). Any user may change their password, but only **Administrators** may add users and edit permissions.

You access the **User Accounts** page from the **Menu** page in the bottom panel of the AUI.

This section includes the following topics:

- "Types of users", on page 2-67
- "Changing the password", on page 2-68
- "Removing an account", on page 2-70
- "Setting autologin status (local only)", on page 2-70
- "Removing an account", on page 2-70

**Figure 2.50: User Accounts Page**

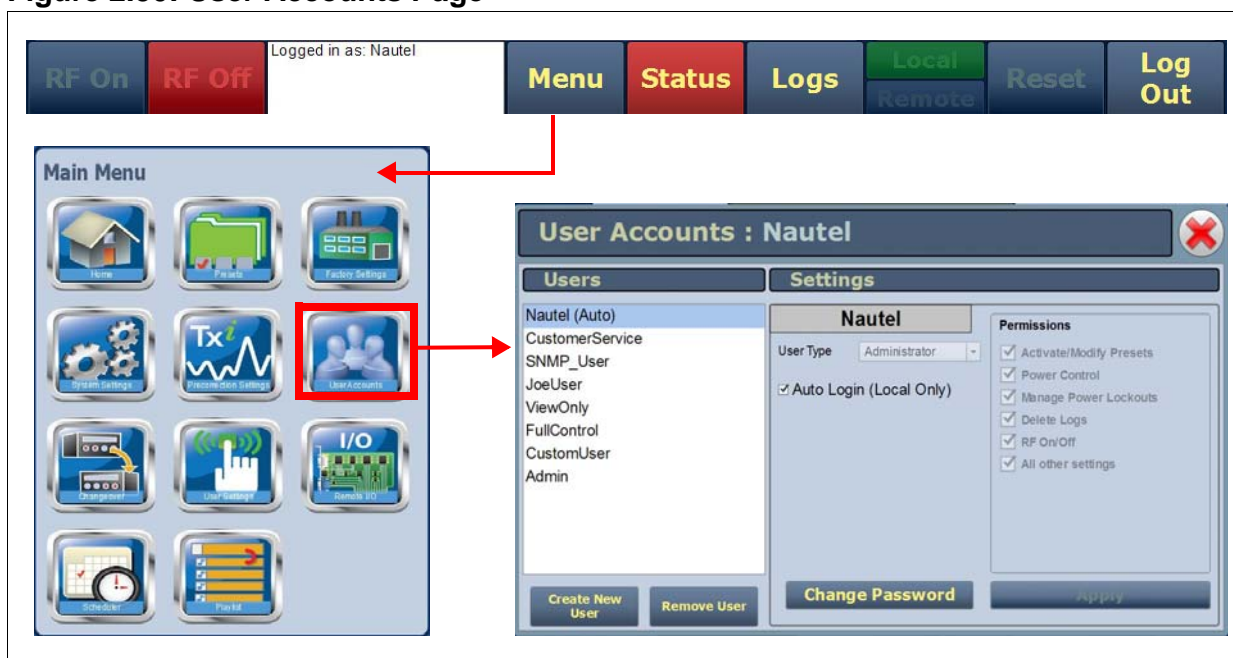

In the **User Accounts** page, users are listed in a panel on the left side of the screen, operations appear along the bottom and settings appear in the center.

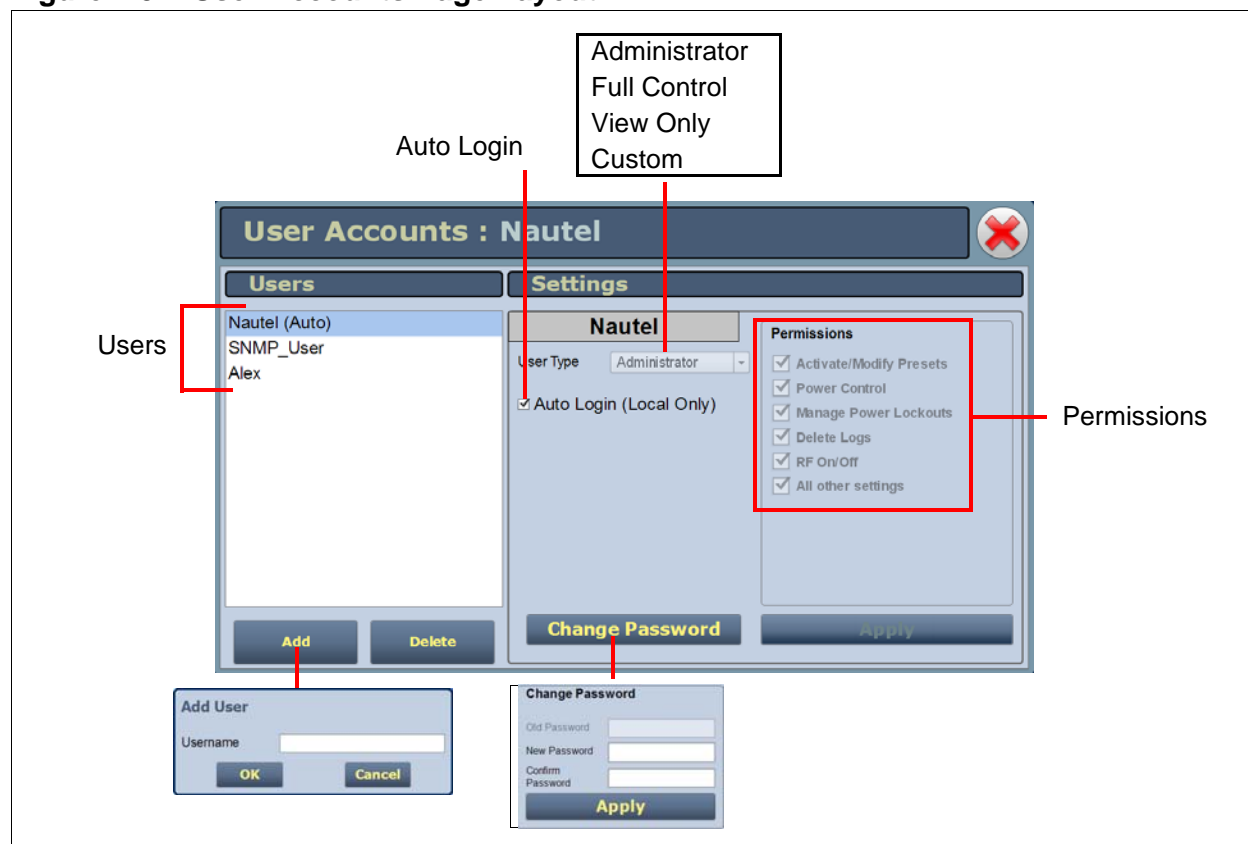
**Figure 2.51: User Accounts Page Layout**

## TYPES OF USERS

You assign a user type to identify the permissions available to that user. All users have permission to change their own username and password (see [Figure 2.51](#)) but there are other realms of permission. The AUI operates with the following user types:

- **View Only:** Can monitor equipment data only, with no administrative or control functions.
- **Full Control:** Can monitor and control equipment, with no administrative functions.
- **Administrator:** Can perform all functions. Only an **Administrator** can edit user information.
- **Custom:** Administrator can customize the user permissions by manually selecting the permission levels.

## ADDING A USER

You must be an **Administrator** to use this function.

Procedure to add a user (see [Figure 2.51 on page 2-67](#)):

1. Open the **User Accounts** page.
2. Press **Add** (bottom of the screen) to open a small window.
3. Beside **Username**, enter a name that identifies the new user, and press **OK**.
4. Select the new user to edit the settings.
5. Beside **User Type**, press the arrow to reveal a drop-down menu and select a type of user. If you select **Custom** as the type of user, then go to the **Permission** section of the screen and mark individual permissions (see ["Changing permissions", on page 2-69](#)).
6. Press **Apply** to confirm your entries and create a new user or press **Cancel** to ignore your entries and exit the small window without creating a new user.

## CHANGING THE PASSWORD

Any user can change their own password. You must be an **Administrator** to change another user's password.

Procedure to change a password (see [Figure 2.51 on page 2-67](#)):

1. Open the **User Accounts** page.
2. Select a user from the "List of Users".
3. Press **Change Password** (bottom of the screen) to open a small window.
4. Beside **Old Password**, enter the existing password.
5. Beside **New Password**, enter a new password.
6. Beside **Confirm Password**, retype the new password.
7. Press **Apply** to replace the old password with the new one and exit this menu.

## CHANGING PERMISSIONS

You must be an **Administrator** to edit this function.

All users have permission to change their own username and password (see [Figure 2.51](#)). You can customize the permissions assigned to a user or simply pick a predetermined set of permissions based on the user type.

Procedure to change user permissions (see [Figure 2.51](#)):

1. Open the **User Accounts** page.
2. Select a user from the “List of Users” to display the permissions for that user in the center of the “Permissions” window. The permissions associated with the selected user are identified with a checkmark.
3. Press on **User Type** to reveal a drop-down menu and select a new type of user.
4. If the user type in [Step 3](#) is **Custom**, set individual permissions. Under “Permissions”, place a checkmark beside each permission that you want to associate with the user. The boxes work like a toggle - click in the circle to place a checkmark and click again to remove the checkmark. Choose one or more of the following options:
  - **Activate/Modify Preset** - Allows the user to modify presets and change the active preset.
  - **Power Control** - Allows the user to change the power setpoint of the transmitter.
  - **Manage Power Lockouts** - Allows the user to modify and select the active power lockout.
  - **Delete Logs** - Allows the user to remove log entries.
  - **RF On/Off** - Allows the user to turn the RF output on and off.
  - **All Other Settings** - Allows the user to adjust all settings not mentioned above, except for administrating user accounts.
5. Press **Apply** to assign the new permissions to the selected user.

## SETTING AUTOLOGIN STATUS (LOCAL ONLY)

You must be an **Administrator** to edit this function. This setting defines which account will be automatically entered on the local AUI. If no account is set for **Auto Login**, the login screen will appear when the local AUI boots. Remote users always require a login. There can only be one account that is set for **Auto Login**.

Procedure to change your auto login status (see [Figure 2.51](#)):

1. Open the **User Accounts** page.
2. Select a user from the “List of Users”.
3. Beside **Auto Login (Local only)**, press the checkbox to activate this feature. When this feature is activated, the local user is automatically logged into the local transmitter with all the rights and privileges assigned to that user.
4. Press **Apply** to apply this change to the user.

## REMOVING AN ACCOUNT

You must be a **Administrator** to edit this function.

To remove a user account (see [Figure 2.51](#)):

1. Open the **User Accounts** page.
2. Select a user from the “List of Users”.
3. Press **Delete** to delete the user from the list.



## USER SETTINGS

The **User Settings** page (see [Figure 2.52](#)) allows you to modify various custom user settings such as network settings and email notification settings.

**Figure 2.52: User Settings Page**

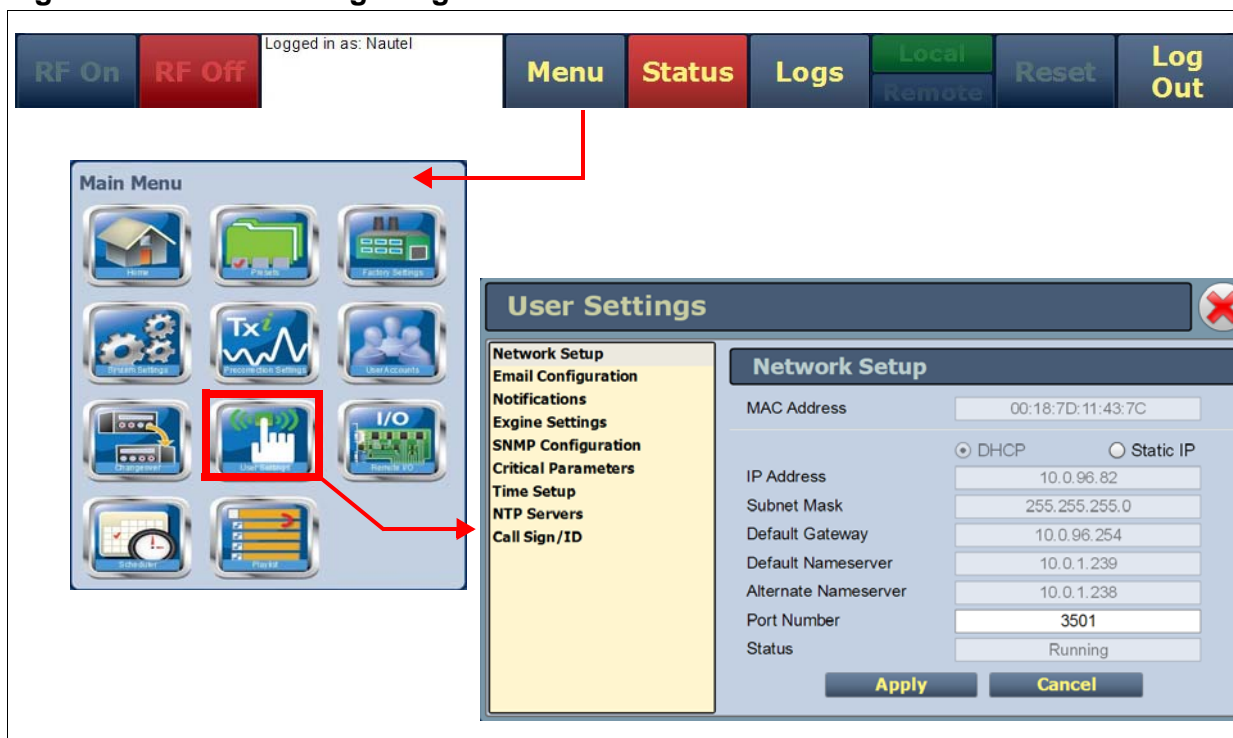

This section includes the following topics:

- "Setting up the network", on page 2-72
- "Email Configuration", on page 2-74
- "Notifications", on page 2-76
- "Configuring Exgine settings", on page 2-78
- "SNMP Configuration", on page 2-81
- "Critical Parameters", on page 2-83
- "Time Setup", on page 2-84
- "NTP Servers", on page 2-86
- "Setting call sign/ID", on page 2-88

## SETTING UP THE NETWORK

The **Network Setup** page (see [Figure 2.52](#)) allows you configure parameters for connecting the AUI to your network. Modify network settings as follows:

**Figure 2.53: User Settings - Setting up the Network**

The screenshot shows the 'User Settings' interface. On the left is a navigation menu with 'Network Setup' selected. The main panel, titled 'Network Setup', displays the following configuration:

MAC Address	00:18:7D:11:43:7C
IP Address	10.0.96.82
Subnet Mask	255.255.255.0
Default Gateway	10.0.96.254
Default Nameserver	10.0.1.239
Alternate Nameserver	10.0.1.238
Port Number	3501
Status	Running

At the bottom of the main panel are 'Apply' and 'Cancel' buttons. The 'DHCP' radio button is selected.

1. Open the **User Settings** page by pressing **Menu/User Settings** in the **Home** page.
2. Select the **Network Setup** option (left-side of the screen) to display related information and associated parameters in the center of the screen.
3. Enter the following parameters:
  - **Mac Address** - Displays a number that serves as unique network adapter identifier. This is set by the manufacturer and is displayed for informational purposes only. It may be necessary to use this number to allow the AUI to access your network.
  - **DHCP or Static IP** - Defines whether the IP Address, Subnet Mask, Default Gateway, Default Nameserver and Alternate Nameserver will be provided manually (static IP) or automatically by the access point (i.e., a router) through DHCP. In either case, the access point must be configured with the correct settings, which match the settings on the AUI in order for the AUI to access the network. Your parameter selection affects other parameter entries. If Static IP was selected, enter the IP Address, Subnet Mask and Default Gateway.

- Subnet Mask - Masks an IP address, and divides the IP address into network address and host address (normally set to 255.255.255.0)
- Default Gateway - Defines the address of the network access point.
- Default Nameserver - Address that identifies the DNS host
- Alternate Nameserver- Redirects the name server
- Port Number - Used to identify the senders and receivers of messages. Defaults to 3501.

**NOTE:** If the transmitter is connected to the Internet via a firewall, and remote access is required, the port number for external incoming connections that are to be routed to the transmitter **MUST** be the same as the port number that the transmitter listens to on the internal network.

- Status - Identifies the network status (Running or Not Running). Running indicates the transmitter is successfully connected to the network. Not Running indicates the transmitter is not communicating on the network, possibly due to a disconnected cable, incorrect network settings, a malfunctioning network device, etc..
4. Press **Apply** to accept your entries.

## EMAIL CONFIGURATION

The *Email Configuration* page (see [Figure 2.54](#)) allows you to configure email parameters (e.g., server name and port number).

**Figure 2.54: User Settings - Configuring Email**

The screenshot shows a web interface for configuring email settings. The main window is titled "User Settings" and contains a sidebar with various configuration categories. The "Email Configuration" category is selected, displaying a form with the following fields and values:

Field	Value
Email Server	test
Port Number	25
Transmitter Name	test
Sender Email Address	a@b.com
Authentication Required (AUTH LOGIN)	<input checked="" type="checkbox"/>
Username	test
Password	

At the bottom of the form are three buttons: "Apply", "Cancel", and "Test".

Procedure to configure emails:

1. Open the *User Settings* page by pressing **Menu > User Settings** in the *Home* page.
2. Select the **Email Configuration** option (left-side of the screen) to display related information and associated parameters in the center of the screen.
3. Enter the following parameters:
  - **Email Server** - The email server name depends on your network setup variables (see ["Setting up the network", on page 2-72](#)). If your network is set to **Static IP**, then enter your outgoing mail server's IP address. If your network is set to **DHCP**, then enter your outgoing mail server's IP address or DNS.
  - **Port Number** - Enter the information that will identify the senders and receivers of messages. Typically, this is set to 25 for SNMP systems.

- **Transmitter Name** - Enter an identification for the transmitter/station (e.g., NX300\_WXYZ). This name will be included in notification emails.
- **Sender Email Address**- Enter as a standard email address (e.g., a@b.com), This is the address that will appear in the “From:” line in any email notification received from the transmitter. It should be an email registered with the email server.
- **Authentication Required** - If your email server requires authentication to send emails, click the check box and enter the appropriate Username and Password to allow this. If the check box is not selected, the Username and Password fields do not appear. Only TLS secured SMTP servers are supported.
- **Username** - Enter the username for your outgoing email server.
- **Password** - Enter the password for your outgoing email server.

**NOTE:** The transmitter will automatically handle encryption if the associated mail server requires it.

4. When complete click **Apply** or click **Cancel** to restore the previous settings. Use the **Test** button to enter an email address to test your settings. Enter the email address destination for the test mail and click the **OK** button to send the test email or the **Cancel** button to return to the *Email Configuration* page.
5. Select a new **User Settings** option or press **X** to exit this page.

## NOTIFICATIONS

The **Notifications** page (see [Figure 2.55](#)) allows you to configure the email notifications that are sent to represent upon user-selected alarm occurrences.

**Figure 2.55: User Settings - Notifications**

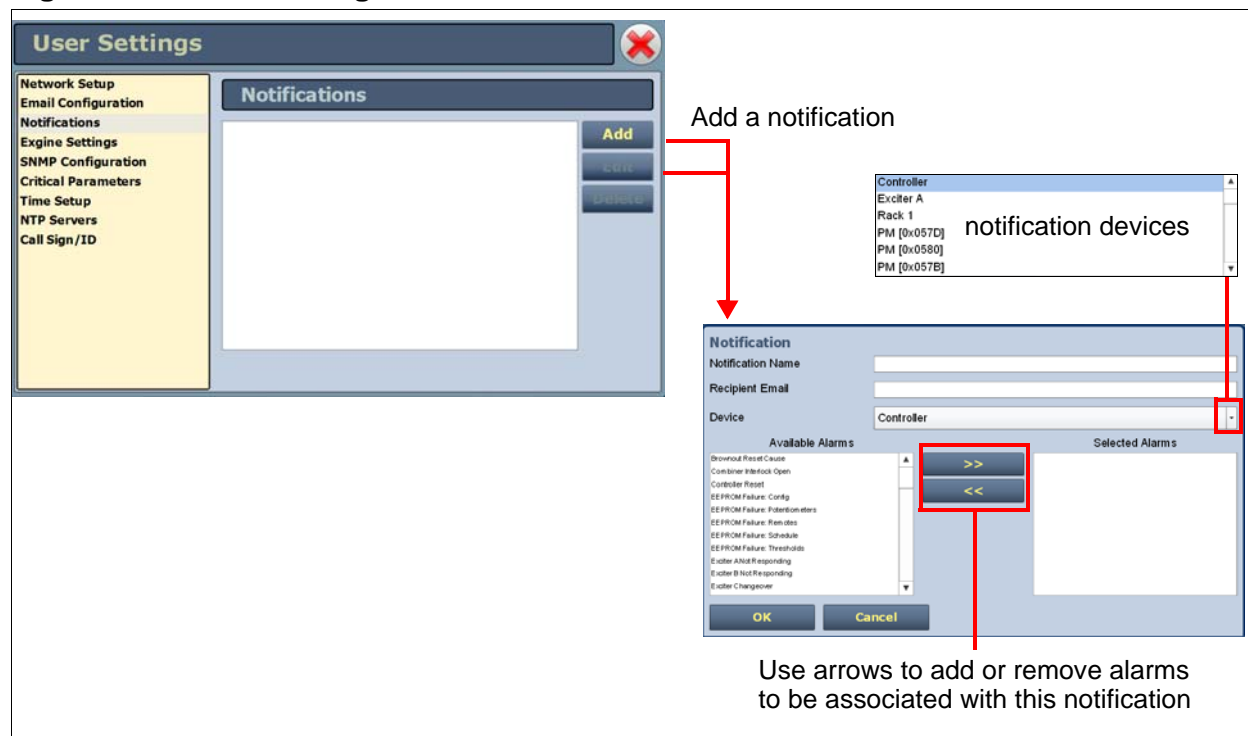

Procedure to configure notifications:

1. Open the **User Settings** page by pressing **Menu > User Settings** in the **Home** page.
2. Select the **Notifications** option (left-side of the screen) to display a list of pre-existing notifications on the right-side of the screen.
3. Choose from the following options:
  - Select an existing notification and press **Edit** to update/edit the notification list with more information. A window opens where you identify the alarms you wish to update from an established list.
  - Press **Add** to add/create a notification. A window opens where you identify the alarms you wish to add to the list of notifications.

- Select an existing notification and press **Delete** to remove a notification from the list.

The window that opens for both **Add** and **Update** allows you to edit a notification name, a recipient email address, and the notification device. Use the arrows (>> and <<) to select alarms by moving them from the “Available Alarms” list to the “Selected Alarms” list.

4. Repeat the previous step, as required, for each notification.
5. When finished, press **OK** to accept your entries or press **Cancel** ignore your changes, exit this window.
6. Select another option in the *User Settings* page or press **X** to exit the page.

## CONFIGURING EXGINE SETTINGS

The **Exgine Settings** option allows you to set signal parameters and determine IP information for use with the Exgine option (see [Figure 2.56](#), [Figure 2.57](#), [Figure 2.58](#)).

Procedure to configure Exgine settings:

1. Open the **User Settings** page by pressing **Menu > User Settings** in the **Home** page.
2. Select the **Exgine Configuration** option (left-side of the screen) to display a list of pre-existing notifications in the center of the screen. The Exgine window has multiple tabs (**IP**, **Mode** and **Tuning**) that you display by selecting the tab.
3. In the IP tab (see [Figure 2.56](#)), enter the following parameters and press **Apply**.
  - **Protocol** - Selects the E2X protocol to use UDP or TCP. Match this setting to the exporter configuration.
  - **Exgine IP, Netmask and Gateway** - Configure the Exgine's IP network parameters as assigned by the local network administrator. If no gateway is used or assigned, enter 0.0.0.0.
  - **Exporter IP** - Enter the exporter's IP address of the interface where the data stream is originating. It is used to filter E2X traffic in case multiple exporters are used in broadcast mode on a single LAN. 0.0.0.0 is also a valid configuration.
  - **E2X Port** - The exgine expects E2X on port 9000. Some non-Nautel Exporters utilize port 11000 instead.
  - **Mac Address** - Displays a number that serves as unique network adapter identifier. This is set by the manufacturer and is displayed for informational purposes only. It may be necessary to use this number to allow the AUI to access your network

**Figure 2.56: User Settings - Exgine Settings - IP Tab**

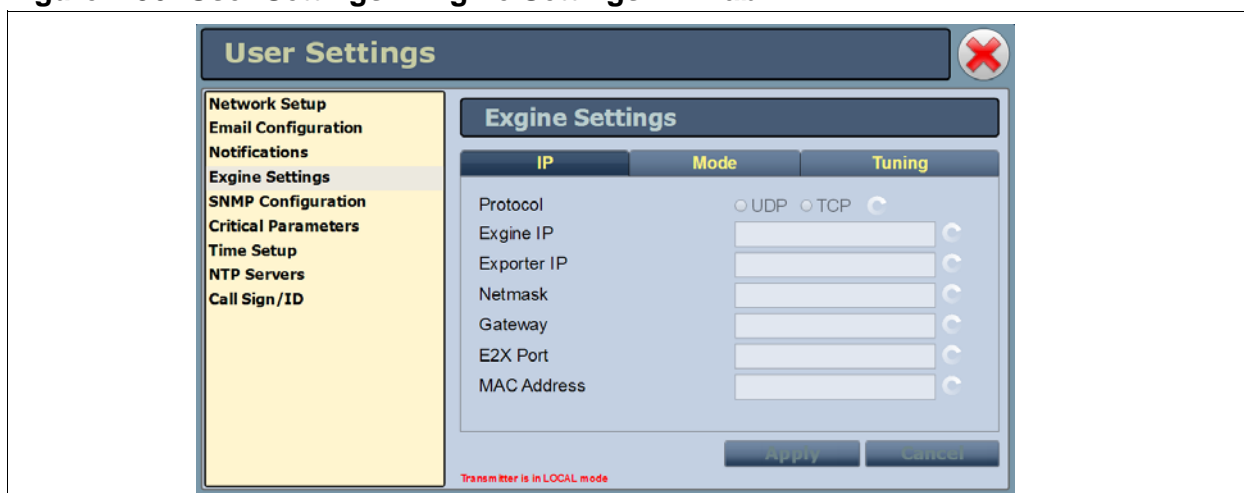



4. In the **Mode** tab (see [Figure 2.57](#)), enter the following parameters and press **Apply**.
  - Default Service Mode - select MA1 or MA3
  - Digital Carriers - select On or Off
  - Enhanced Carriers - select On or Off
  - Analog Transmission - select On or Off
  - Analog Bandwidth - select 5kHz, 8kHz or Bypassed
  - Enhanced Power Levels - select High or Low
  - PIDS Power Levels - select High or Low

**Figure 2.57: User Settings - Engine Settings - Mode Tab**

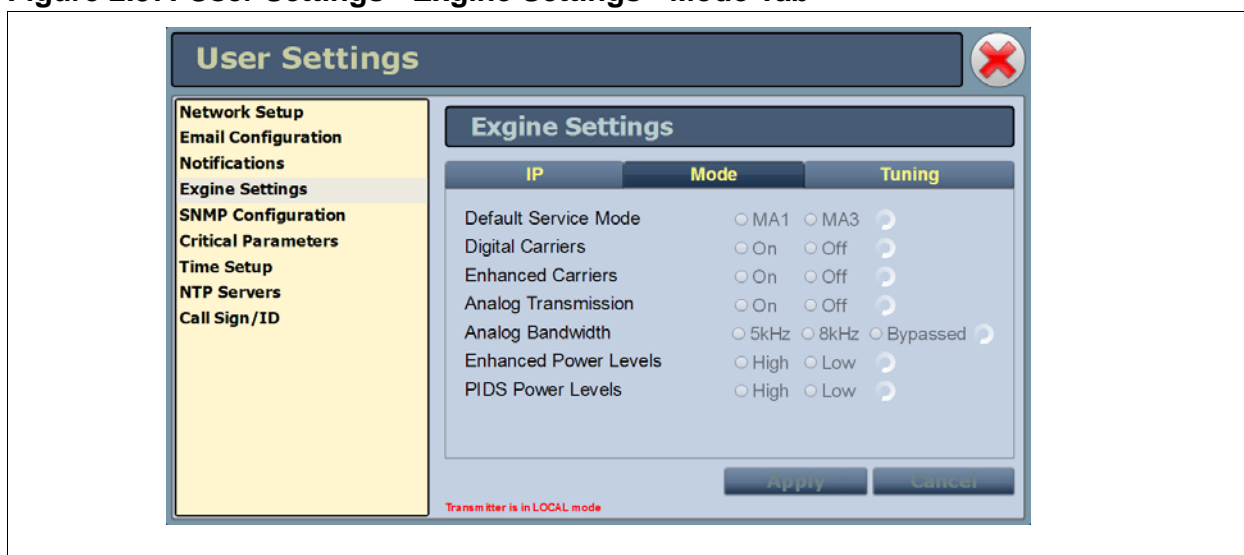

5. In the **Tuning** tab (see [Figure 2.58](#)), enter the following parameters and press **Apply**.
  - **Analog Gain** - a linear scale factor which scales the analog modulation level with respect to the carrier level. Normally set to 1.0 with a 0 dBFS audio signal applied to the Exporter.
  - **Upper Primary Level Adjust** - Adjusts the power level of the upper sideband within the range of +20dB and -100 dB. Should be zero by default.
  - **Lower Primary Level Adjust** - Adjusts the power level of the lower sideband within the range of +20dB and -100 dB. Should be zero by default.

**Figure 2.58: User Settings - Exgine Settings - Tuning Tab**

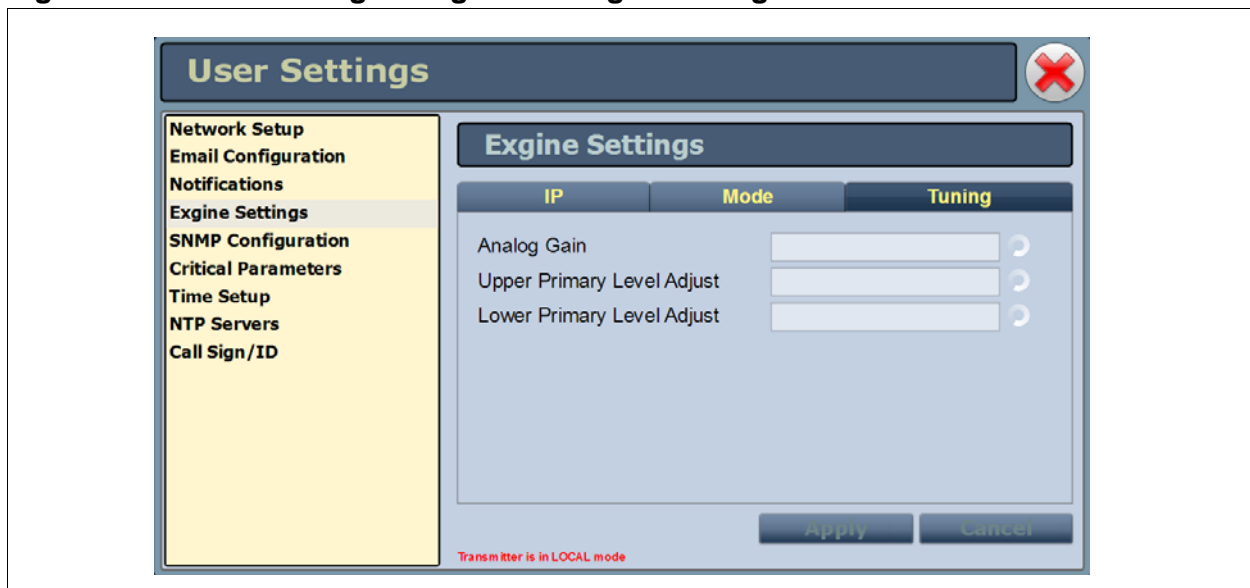

Refer to the *NX50 Troubleshooting Manual* for examples of the Exgine interface menu screens.

## SNMP CONFIGURATION

The SNMP configuration page provides a user with a means to configure the SNMP agent and the associated traps (see [Figure 2.59](#)).

**Figure 2.59: User Settings - SNMP Configuration - Agent Tab**

The screenshot shows a web-based configuration interface. At the top is a dark blue header with the text "User Settings" and a red "X" icon in the top right corner. Below the header is a left-hand navigation menu with a yellow background, listing various settings categories: Network Setup, Email Configuration, Notifications, Engine Settings, SNMP Configuration (which is highlighted), Critical Parameters, Time Setup, NTP Servers, and Call Sign/ID. The main content area is titled "SNMP Configuration" and has two tabs: "Agent" (selected) and "Traps". Under the "Agent" tab, there are several input fields: "Agent Port" with the value "161", "Read Community" with "\*\*\*\*\*", "Confirm" with "\*\*\*\*\*", "Write Community" with "\*\*\*\*\*", and another "Confirm" with "\*\*\*\*\*". There is a checked checkbox for "Enable Traps". Below these are "Trap Receiver IP" with "0.0.0.0" and "Trap Receiver Port" with "162". At the bottom right of the form are "Apply" and "Cancel" buttons.

### AGENT SETTINGS

Using the **Agent** tab you can configure the SNMP agent as follows:

1. Enter the five fields, noting the following:
  - **Agent Port:** Enter the UDP port where the SNMP agent checks for requests. The default setting is 161. If your transmitter is behind a firewall, you must open this port to use SNMP.
  - **Read Community:** Enter the password for the SNMP client application to allow acquisition of channel values. Provide confirmation of this password in the **Confirm** field.
  - **Write Community:** Enter the password for the SNMP client application to allow changing of channel values. Provide confirmation of this password in the **Confirm** field.
2. Click the **Enable Traps** check box to allow the SNMP agent to send trap notifications. Enter the two additional fields as follows:

- **Trap Receiver IP:** Enter the IP address of the computer to which the SNMP agent will send trap notifications. The computer must be running an SNMP application that is configured to receive traps. The SNMP agent will send trap notifications to at most one receiver.
  - **Trap Receiver Port:** Enter the UDP port where the SNMP agent will send traps. The default setting is 162.
3. When complete click **Apply** or click **Cancel** to restore the previous settings.

### TRAPS SETTINGS

A trap is a message sent by an SNMP agent to an SNMP client when an alarm changes state (turns on or off). The message is an SNMP packet that can be interpreted and displayed by an SNMP client application. Using the Traps tab (see [Figure 2.60](#)) select your desired traps as follows:

1. Find the desired alarm(s) by selecting the appropriate **Device** type (Controller, Exciter, Rack, etc.) and scrolling through the Available Traps list. Add or remove traps to and from the Selected Traps list using the >> and << arrow buttons
2. When complete click **Apply** or click **Cancel** to restore the previous setting.

**Figure 2.60: User Settings - SNMP Configuration - Traps Tab**

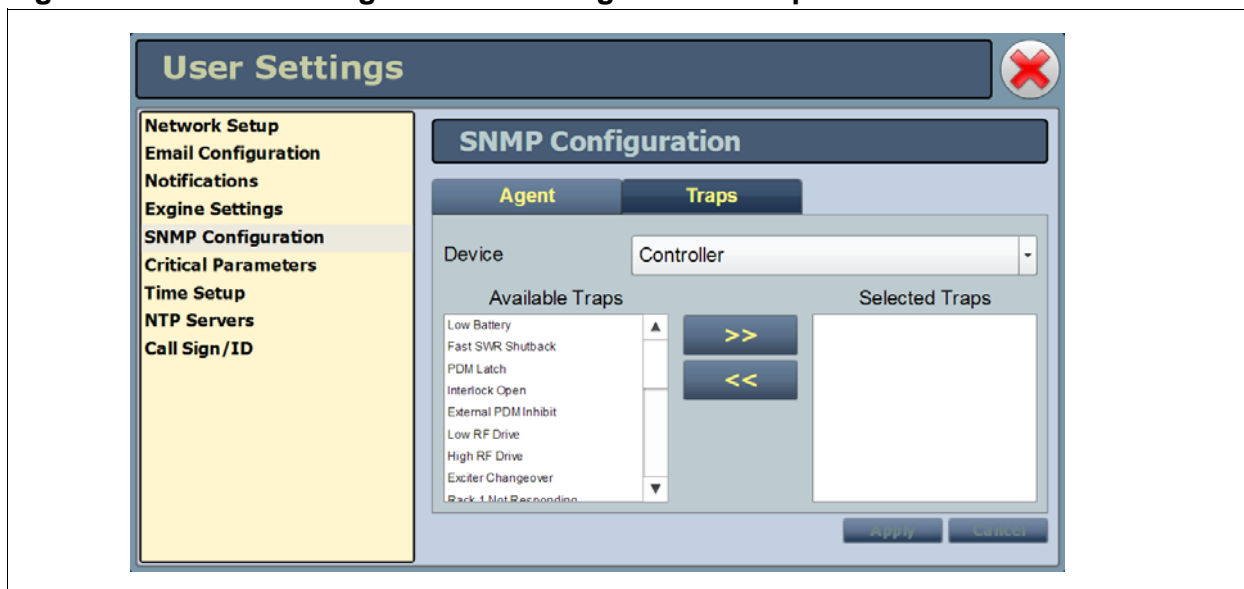

## CRITICAL PARAMETERS

This feature is available through the remote AUI only.

You can capture critical parameter data for the transmitter’s current state using the AUI’s **Critical Parameters** page (see [Figure 2.61](#)). To view this page, select **Critical Parameters** from the **User Settings** page. From this page, you can click **Capture Meters** (reads all meter values), **Capture Alarms** (reads all active alarms), **Capture Presets** (reads current preset) and **Capture Settings** (reads current settings, e.g, active exciter, threshold settings, scale factors, etc.). Once you click the **Capture** button, you can click the associated **Copy** button to copy the data to your Windows clipboard. The data copies in a tab-delimited format and is ideally suited for pasting into an Excel spreadsheet. Click **X** in the upper, right corner to close this page and return to the home page.

**Figure 2.61: User Settings - Critical Parameters**

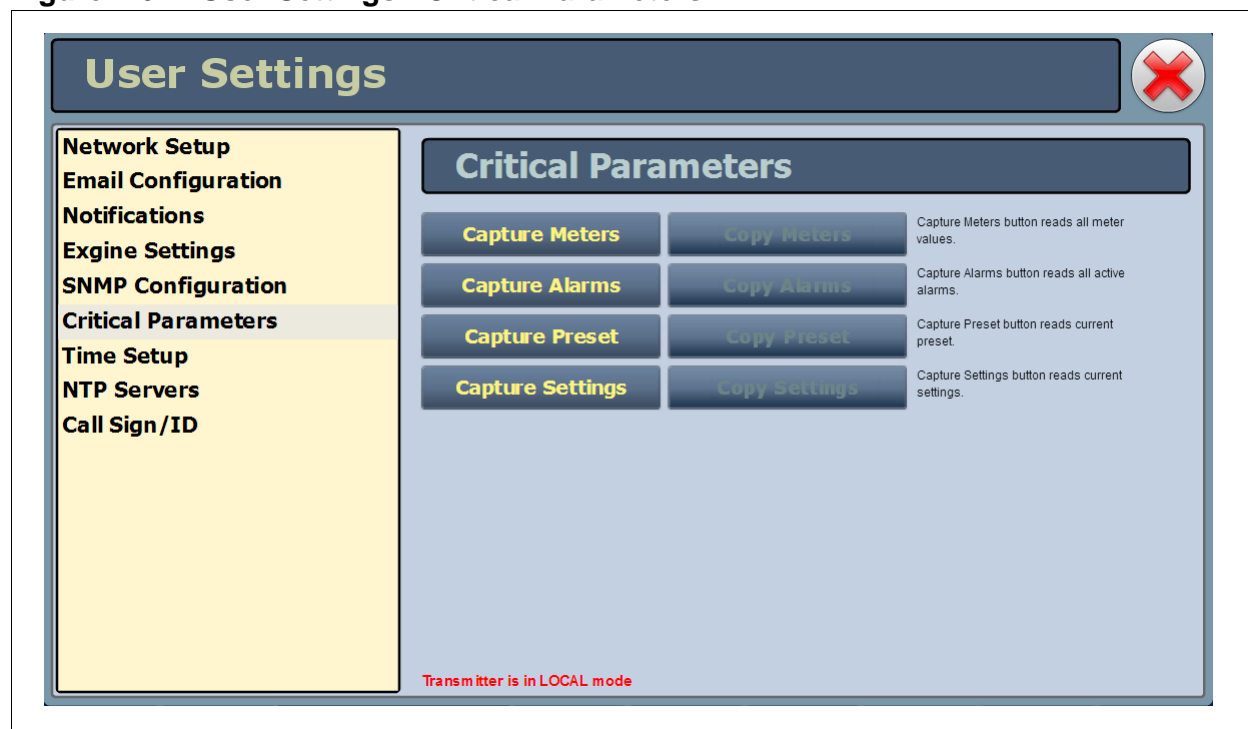

## TIME SETUP

There is an internal clock on the transmitter that has a backup battery and maintains the accurate time and date even during power outages. The **Time Setup** page contains editable fields for the date (month, day and year) and time (hours, minutes, and seconds), which is shown on the main screen of the AUI and used for stamping log entries. The clock operates in 24-hour format (Figure 2.62).

Set the time and date when the transmitter is first installed, and if the backup battery fails.

**Figure 2.62: User Settings - Time Setup**

The screenshot displays the 'User Settings' window with a sidebar on the left containing the following menu items: Network Setup, Email Configuration, Notifications, Exgine Settings, SNMP Configuration, Critical Parameters, Time Setup (highlighted), NTP Servers, and Call Sign/ID. The main panel is titled 'Time Setup' and contains the following fields and controls:

- Time:** Three input fields for Hour (8), Min (31), and Sec (32).
- Date:** Three dropdown menus for Day (18), Month (February), and Year (2013).
- Timezone:** A text input field containing 'America/Halifax UTC -4:00'.
- Region:** A dropdown menu with the text 'Select a region...'.
- Country:** A dropdown menu.
- Zone:** A dropdown menu.

There are two 'Apply' buttons: one centered below the Date fields and another centered below the Timezone, Region, Country, and Zone fields.

The **Time Setup** option allows users to set the exact time and date information as well as regional and timezone settings for a transmitter location. All data received from the AUI server (i.e., logs) are time-stamped in UTC time. Setting the time zone information allows this timestamp to be adjusted for the user-specific time zone.

Procedure to set up the time and date:

1. Select the **Time Setup** option from the left side of the **User Settings** page to open a related window on the right side of the page.

2. Enter the following Time and Date parameters and press **Apply**.
  - **Time** - enter the hour (24-hour clock), minutes (up to 60), and seconds (up to 60).
  - **Date** - select values from the drop-down menus beside Day, Month, and Year.
3. Enter the following location parameters and press **Apply**:
  - **Timezone** - select the appropriate timezone from the drop-down menu
  - **Region** - select the appropriate region from the drop-down menu
  - **Country** - select the appropriate country from the drop-down menu
  - **Zone** - select the appropriate zone from the drop-down menu

## NTP SERVERS

You can configure one or more NTP (Network Time Protocol) servers to allow clock synchronization with all computers on the same network as the NX50. To view the AUI's **NTP Servers** page (see [Figure 2.63](#)), select **NTP Servers** from the **User Settings** options. There are several functions available on this page - enabling NTP, monitoring NTP server status and managing servers.

**NOTE:** The accuracy of the NTP synchronization is related to the distance to the server. For this reason, Nautel recommends that you choose servers in the same country as the equipment. If this is not possible, attempt to get servers from the same continent.

**Figure 2.63: User Settings - NTP Servers**

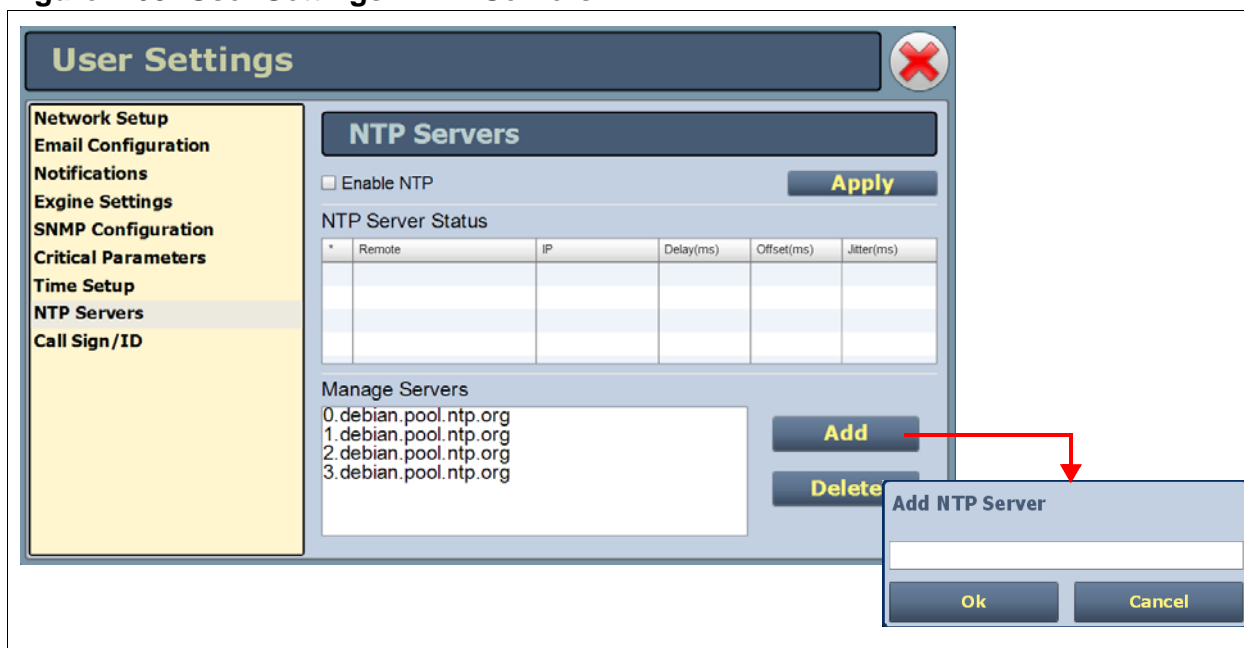

### ENABLING NTP

Enable the NTP function by selecting the **Enable NTP** checkbox. Disable by de-selecting the **Enable NTP** checkbox. Click the **Apply** button to activate any change.

### MONITORING NTP SERVERS

The **NTP Server Status** section displays tabular information on the NTP servers connected to the network. The table includes remote name, IP address, delay, offset and jitter.

- **Remote Name:** Displays the host name of the referenced time source. An asterisk (\*) in the first column marks the reference time source that is currently preferred by the NTP



daemon. A ‘+’ character in the first column marks high quality candidates for the reference time that could be used if the currently selected reference becomes unavailable.

- **IP:** Displays the IP address associated with the **Remote Name**. In some cases the **Remote Name** could be the IP address.
- **Delay:** Displays the round-trip delay (in ms) of the time queries.
- **Offset:** Displays the difference (in ms) between the reference time and the system clock.
- **Jitter:** Displays the magnitude of jitter (in ms) between several time queries.

### MANAGING NTP SERVERS

The **Manage Servers** section displays the NTP server files that have been added. You can **Add** to the list of NTP servers or **Delete** a selected NTP server from the list.

## SETTING CALL SIGN/ID

The Call Sign/ID screen (see [Figure 2.64](#)) can be used to set a name that can be used to identify the transmitter on the AUI. This identification will be displayed on the top banner of the AUI page (e.g., “NX200”).

Enter the call sign or ID in the field and press **Apply** (maximum 15 characters in length).

**Figure 2.64: User Settings - Call Sign/ID**

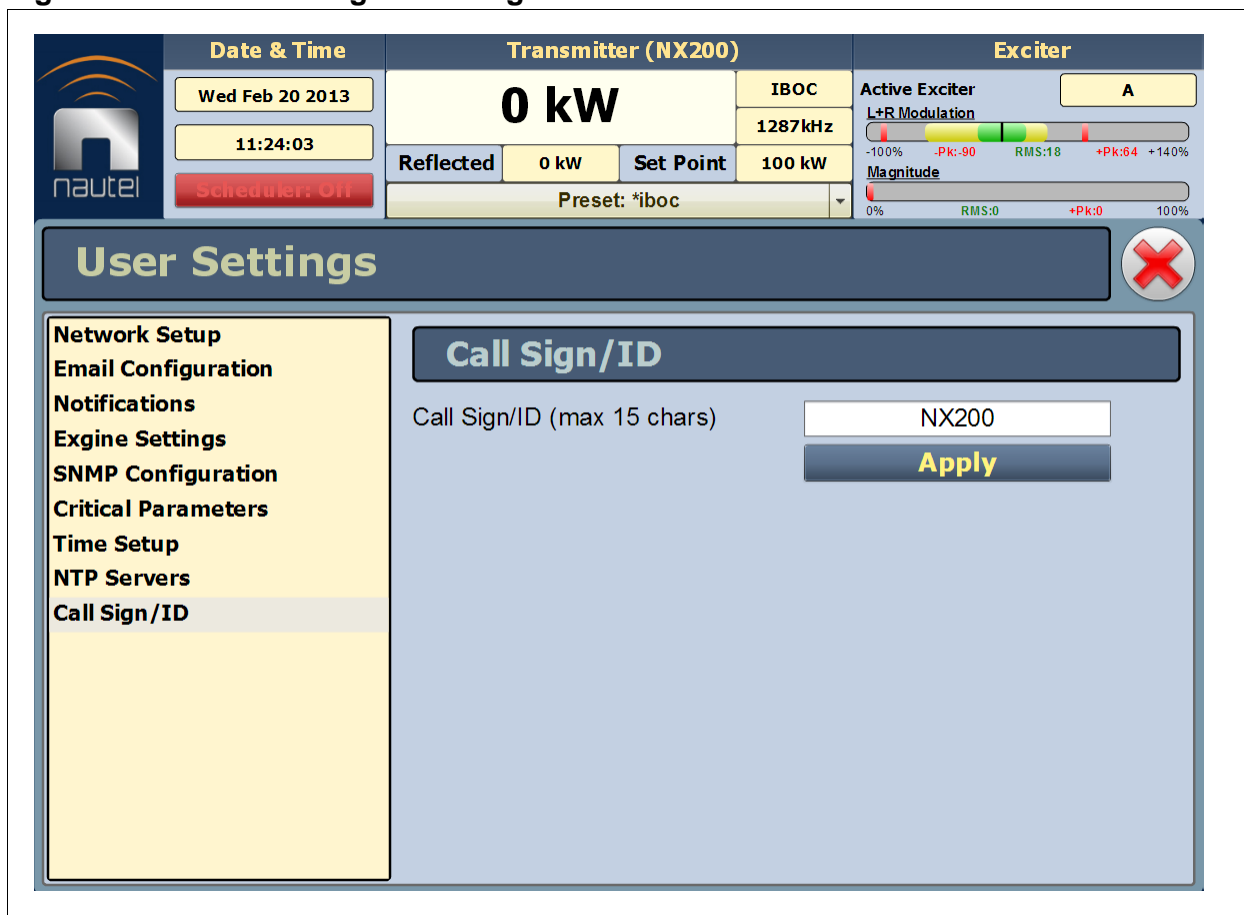

## SYSTEM SETTINGS PAGE

You determine critical system configuration parameters using the **System Settings** page (see [Figure 2.65](#)), which you access from the **Menu** page.

This section includes the following topics:

- "Reset", on page 2-90
- "Upgrade software", on page 2-92
- "Screen configuration", on page 2-91 (available on front panel AUI only)
- "Exciter Clock Calibration", on page 2-93
- "RF Monitor Level", on page 2-94
- "Power Lockout", on page 2-95
- "Power Thresholds", on page 2-96

**Figure 2.65: System Settings Page**

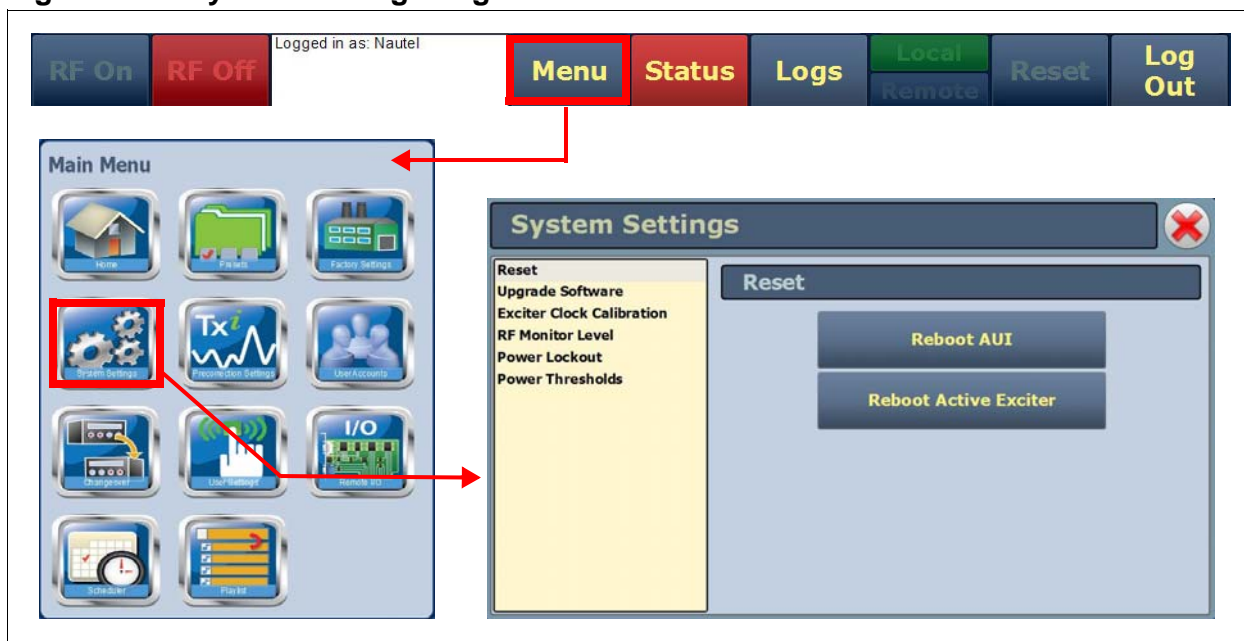

To use this page, select an item from the list on the left-side of the page to open related information on the right side of the page.

## RESET

The **Reset** page (see [Figure 2.66](#)) allows you to reboot two items - the AUI and the active exciter.

**Figure 2.66: System Settings - Reset**



Procedure to reset the AUI or Exciter:

1. Select the **Reset** option from the left side of the **System Settings** page to open a related window on the right side of the page.
2. Reset the items by pressing the appropriate key.
  - To reset the AUI (advanced user interface), press **Reboot AUI**.
  - To reset the active exciter press **Reboot Active Exciter**.

After rebooting a component you may need to log in to the transmitter AUI once again (see ["Logging into the AUI"](#), on page 2-3).

## SCREEN CONFIGURATION

The **Screen Configuration** page (see [Figure 2.67](#)), available on the local AUI only, allows you to perform a calibration on the touchscreen and to configure a screen saver for the local AUI.

**Figure 2.67: System Settings - Screen Configuration (local AUI only)**

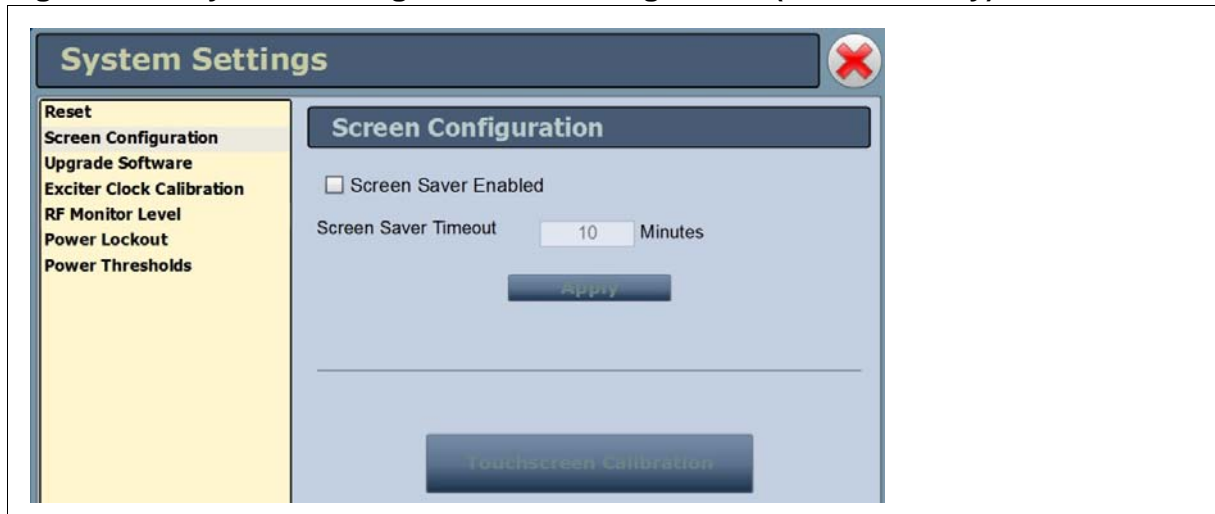

Procedure to calibrate the touchscreen:

1. Select the **Screen Configuration** option on the left side of the **System Settings** page to open a related window on the right side of the page.
2. Press the **Touchscreen Calibration** button. This will initiate a calibration screen, where you will be prompted to sequentially touch three targets from a position of normal use. Touch each target. After the third target, the calibration is complete and the screen display returns to the **Screen Configuration** page.

Procedure to configure a screen saver:

1. Select the **Screen Configuration** option on the left side of the **System Settings** page to open a related window on the right side of the page.
2. To enable a screen saver, press the **Screen Saver Enabled** check box. This allows you to set the **Screen Saver Timeout** period (between 10 and 180 minutes; default is 10 minutes) by pressing in the **Minutes** field and entering, using the numeric keypad that appears, the desired timeout period.
3. Press the **Apply** button to activate the change. The screen saver is now enabled. If the timeout period lapses between local AUI screen touches, the AUI screen will switch to screen saver mode (black screen). Touch the screen to restore the last AUI page.

## UPGRADE SOFTWARE

The **Upgrade Software** page allows for uploading software upgrade files for various transmitter components (e.g., System Controller, AUI, etc). Navigate the page as described below. For more detailed information, see "[Upgrading software](#)", on page 4-1 of this manual.

**Figure 2.68: System Settings - Upgrade Software**

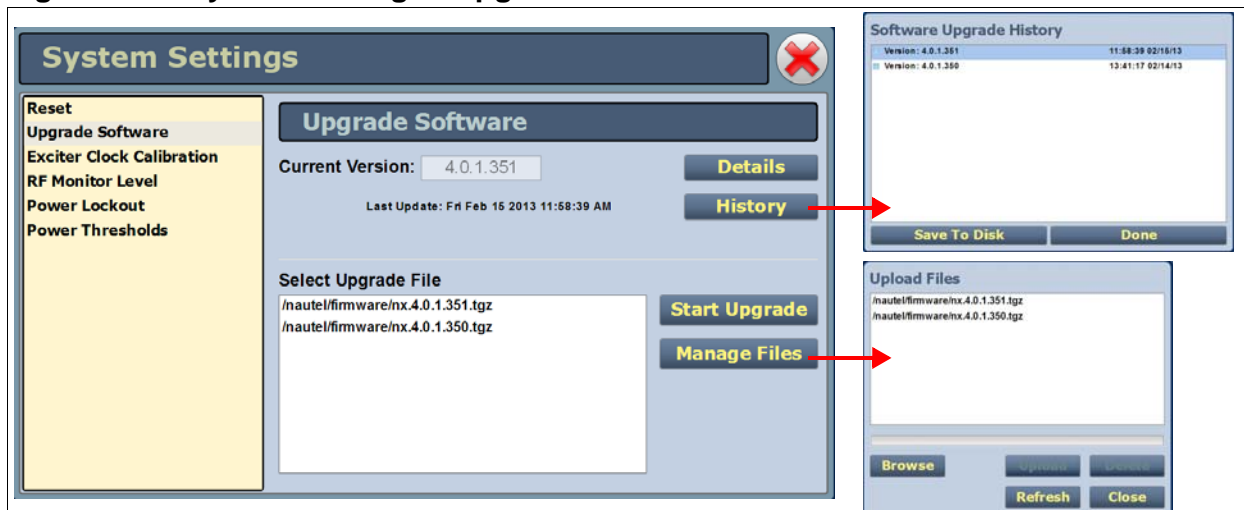

Select the **Upgrade Software** option from the left side of the **System Settings** page to open a related window on the right side of the page. The page consists of the following sections and buttons:

- **Current Version** - indicates the current software version.
- **Select Upgrade File** - displays the upgrade files that have been uploaded to the transmitter.
- **Details** - opens a window containing information about the installed software. If an upgrade file is selected, the screen will show a comparison between the installed version and the selected upgrade by component. identical items are shown in green; different items are shown in red. You can also view the details of the previous upgrade by pressing the **View Last Upgrade** checkbox.
- **History** - displays a window containing a history of the upgrades to the software. Press the + button to expand the details of the software. You can save this information to disk as a txt file from the remote AUI.
- **Start Upgrade** - begins the process of upgrading the current software with the selected upgrade file.
- **Manage Files (available through the remote AUI only)** - opens a window displaying the files you can upload to upgrade the software. You can add or delete files from this list using the **Browse**, **Upload** and **Delete** buttons in the window.

Press **Done** when you are finished to exit the window and return to the **Upgrade Software** page.

## EXCITER CLOCK CALIBRATION

The **Exciter Clock Calibration** page (see [Figure 2.69](#)) allows you to calibrate the internal clock reference to an external 10 MHz clock by pressing the **Calibrate** button. Both exciters are calibrated at the same time. Note: typically, a value change is not required.

The exciter clock may also be synchronized to a reference source, either an external 10 MHz reference connected to A11A1J8 or a Nautel optional GPS sync PWB. The frequency and phase option is applicable for combined systems only. The exciter reference will lock to the external source frequency within 10 mHz (0.01 Hz) using the 10 MHz sync input, to within 2 mHz (0.002 Hz) using the GPS sync card without an antenna, and to within the the quality of the GPS system when using the GPS sync card with an antenna.

**Figure 2.69: System Settings - Exciter Clock Calibration**

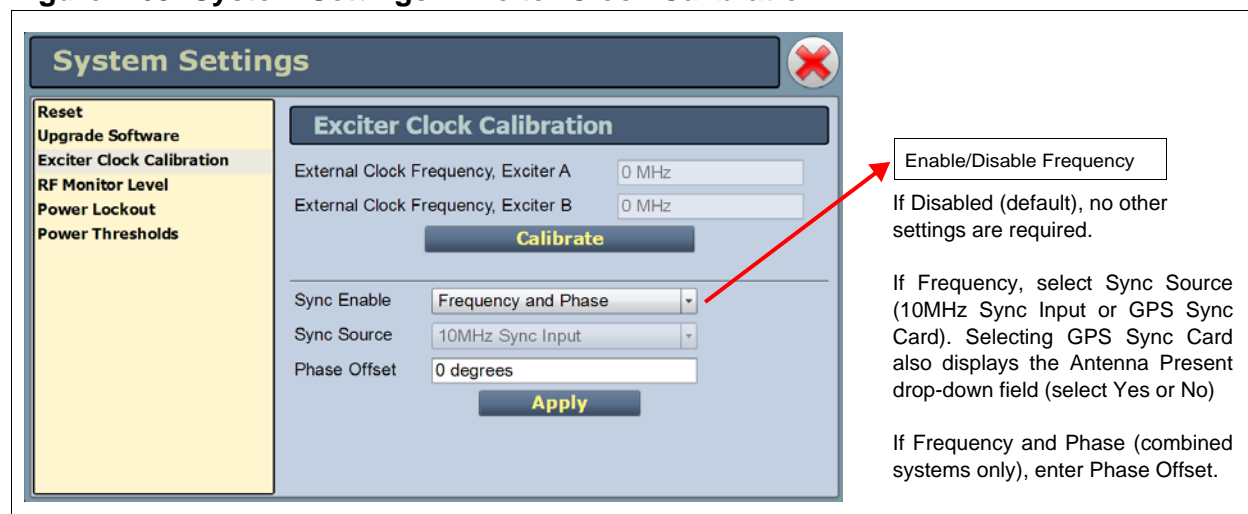

Procedure to calibrate the exciter clock:

1. Select the **Exciter Clock Calibration** option from the left side of the **System Settings** page to open a related window on the right side of the page.
2. Connect an external 10 MHz source to A11A1J8, verify a value near 10 MHz displays in both **External Clock Frequency** fields, and press **Calibrate**.

Procedure to synchronize the exciter clock:

1. Select the **Exciter Clock Calibration** option from the left side of the **System Settings** page to open a related window on the right side of the page.
2. Connect a source (10 MHz input or GPS sync).

3. Select **Frequency** in the **Sync Enable** drop-down menu.
4. Select the appropriate source (**10MHz Sync Input** or **GPS Sync Card**) in the **Sync Source** drop-down menu.

## RF MONITOR LEVEL

The **RF Monitor Level** page allows you to set values for the **Gain at Full Power** (in dB) (see [Figure 2.70](#)) on the amplifier that drives the **RF Monitor** output. The RF monitor is factory set to provide a level of 5 V rms into 50 ohm (27 dBm).

The **Current Gain** value is shown for reference. Increase the gain to increase the RF monitor output level; decrease the gain to decrease the RF monitor output level. The transmitter will attempt to maintain this level at all power set points (see [Figure 2.70 on page 2-94](#)):

**Figure 2.70: System Settings - RF Monitor Level**

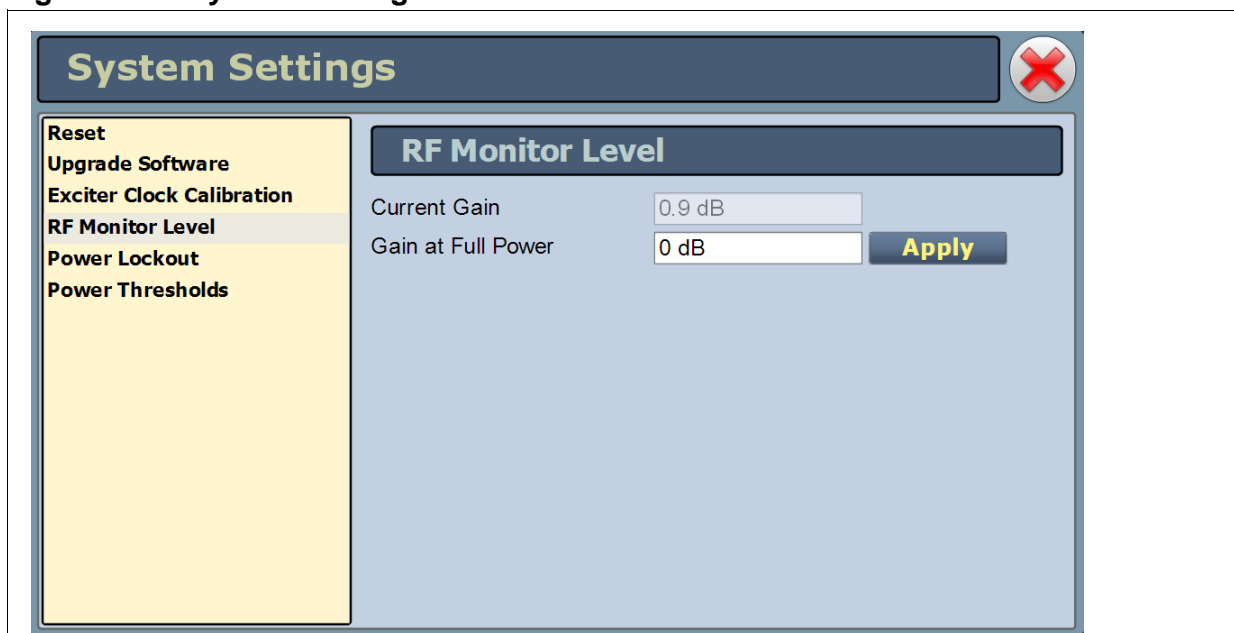

Procedure to set the RF monitor level:

1. Select the **RF Monitor Level** option from the left side of the **System Settings** page to open a related window on the right side of the page.
2. Observe the **Current Gain** value and its corresponding RF monitor level (measured). Enter the new **Gain at Full Power** value to increase or decrease the RF monitor level.
3. Press **Apply**. Verify the measured RF monitor level is as desired. Readjust as necessary.



## POWER LOCKOUT

The **Power Lockout** page (see [Figure 2.72](#)) allows you to set a high power limit for the transmitter. There is provision to set up to eight different limits (which can be used to accommodate daytime/night-time patterns or different antennae), but only the selected limit is active. You can also select a high power limit using a digital remote input (see [Digital inputs on page 2-117](#)).

The transmitter power cannot increase beyond the active limit. For analog and hybrid modes of operation the displayed power limits represent carrier power. For DRM mode, the displayed power limits represent RMS power. If the active preset set point is greater than the active lockout limit, a **High Power Lockout** alarm will appear on the **Transmitter Status** page.

For basic transmitter operation, you must configure and enable at least one of the eight high power limits. **Max Power Lockout 1** is factory set for the transmitter's maximum output power. Set up a power lockout as follows:

**Figure 2.71: System Settings - Power Lockout**

Levels	
Max Power Lockout 1	27500 W
Max Power Lockout 2	0 W
Max Power Lockout 3	0 W
Max Power Lockout 4	0 W
Max Power Lockout 5	0 W
Max Power Lockout 6	0 W
Max Power Lockout 7	0 W
Max Power Lockout 8	0 W

1. Select **Power Lockout** from the left side of the **System Settings** page to open a related window on the right side of the page.
2. Select the desired **Active Power Lockout** (Max Power Lockout 1 through 8) from the drop-down menu
3. Enter the desired **Power Lockout** level for each of the eight lockout options, noting it will represent the maximum allowable power level.
4. Press **Apply** to activate the change(s) or press **Cancel** to abort.

## POWER THRESHOLDS

The **Power Thresholds** page (see [Figure 2.72](#)) allows you to set two distinct low forward power thresholds the transmitter. These thresholds are for monitoring purposes only. The transmitter will not shut back if these thresholds are crossed, but alarm notifications are generated for each of the two thresholds (**Low Forward Power Threshold 1** and **Low Forward Power Threshold 2**) on the **Transmitter Status** page.

**Figure 2.72: System Settings - Power Thresholds**



1. Select **Power Thresholds** from the left side of the **System Settings** page to open a related window on the right side of the page.
2. Enter the desired low power threshold level for each of the two options, noting the level represents the percentage of the normal operating setpoint. The default settings for **Low Forward Power Threshold 1** and **2** are 50% and 25%, respectively.
3. Press **Apply** to activate the change(s) or press **Cancel** to abort.

## PRECORRECTION SETTINGS PAGE

You control various critical parameter functions using the *Precorrection* page(see [Figure 2.73](#)), which you access from the *Menu* page .

**NOTE:** These settings will normally be generated at the factory, based on the desired modes of operation, and should not require user adjustment.

This section includes the following topics:

- "Mag-Phase Delay", on page 2-98
- "B+ Setpoint", on page 2-99
- "AM-AM Correction", on page 2-100
- "AM-PM Correction", on page 2-101
- "Envelope Equalization", on page 2-102
- "Configurations", on page 2-103
- "Exciter Synchronization", on page 2-105

**Figure 2.73: Precorrection Settings Page**

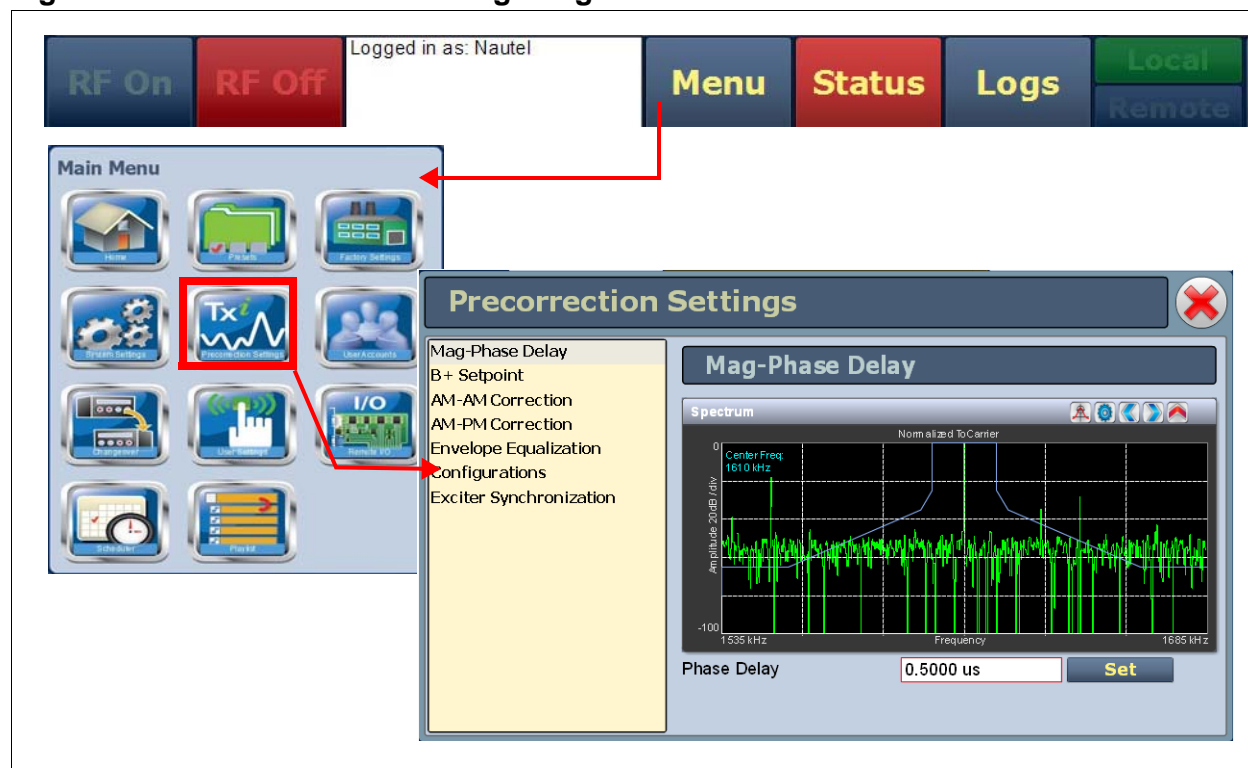

To use this page, select an item from the list on the left-side of the page to open related information on the right side of the page.

## MAG-PHASE DELAY

The *Mag-Phase Delay* page (see [Figure 2.74](#)) allows for setting the difference in delay between the magnitude (PDM) path and phase (RF drive) path in the exciter. Changing this delay can help to level out and minimize spectral regrowth, providing improved spectral performance and increased margin under the mask. Typically, the delay is set between 0 and 1 us. Use the spectrum analyzer instrument panel displayed in this section to verify applied changes are satisfactory.

The value is factory set and changes are not typically required unless the antenna (load) network has changed. Minor adjustments may be required to optimize IBOC or DRM spectral performance. If so, enter the *Phase Delay* value (between -10 us and +10 us) and press **Apply**.

**Figure 2.74: Precorrection - Mag-Phase Delay**

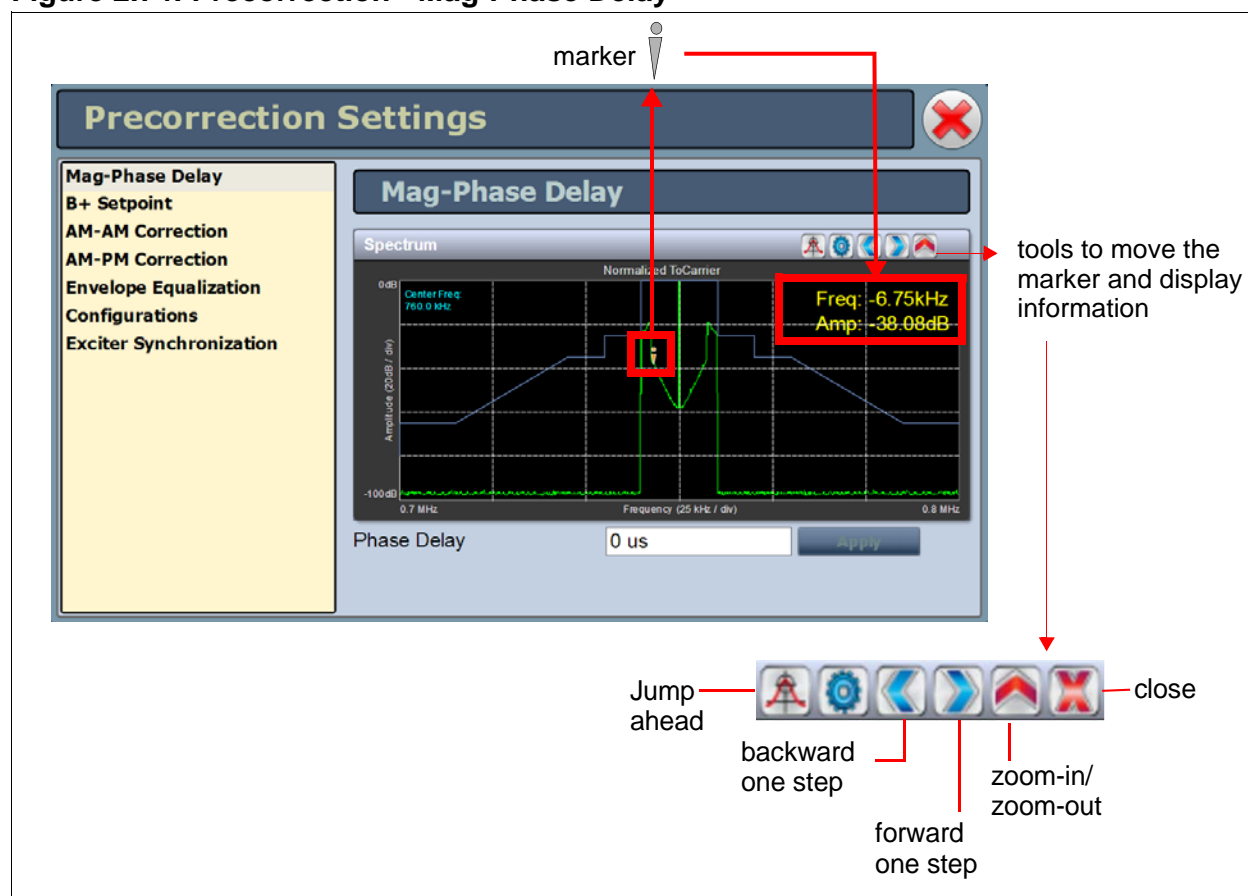

## B+ SETPOINT

The **B+ Setpoint** page (see [Figure](#) ) allows you to identify the **B+ Setpoint** (nominally 400 V). This value does not normally require user adjustment.

**Figure 2.75: Precorrection - B+ setpoint**

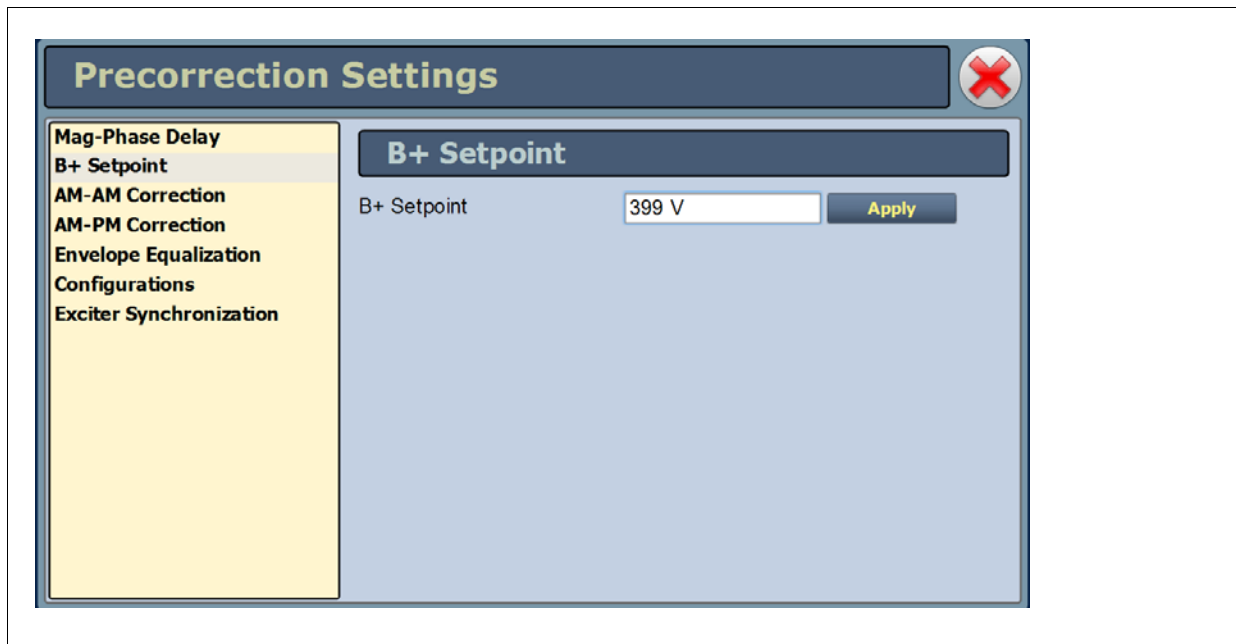

Enter the value and press **Apply**.

## AM-AM CORRECTION

The **AM-AM Correction** page (see [Figure 2.76](#)) allows you to load or capture a set of AM-AM correction curves. You can **Load** or **Delete** curves in this list; you can also capture a curve. When you select **Capture**, the AM-AM Correction window is displayed. Press **Done** to capture the curve, type a name for the curve, then press **Save** (or **Cancel**).

**CAUTION:**

Making changes to the AM-AM Correction curves automatically places the transmitter in analog AM mode, with full-scale sine-wave modulation. To avoid undesirable output or possible antenna damage, it is highly recommended that you perform these calibrations while operating the transmitter into a test load.

Value changes are not typically required. Up to three curves can be saved in memory.

AM-AM curves correct for a type of non-linearity where a change in input amplitude does not cause a linearly proportional change in output amplitude. By applying a test signal and monitoring the output of the transmitter, the exciter will generate a table of values describing the required gain versus input signal level in an attempt to find the inverse curve to the AM-AM non-linearity, and provide a more linear amplifier. Applying the proper AM-AM correction will result in lower audio distortion and better spectral performance in digital modes of operation.

**Figure 2.76: Precorrection AM-AM**

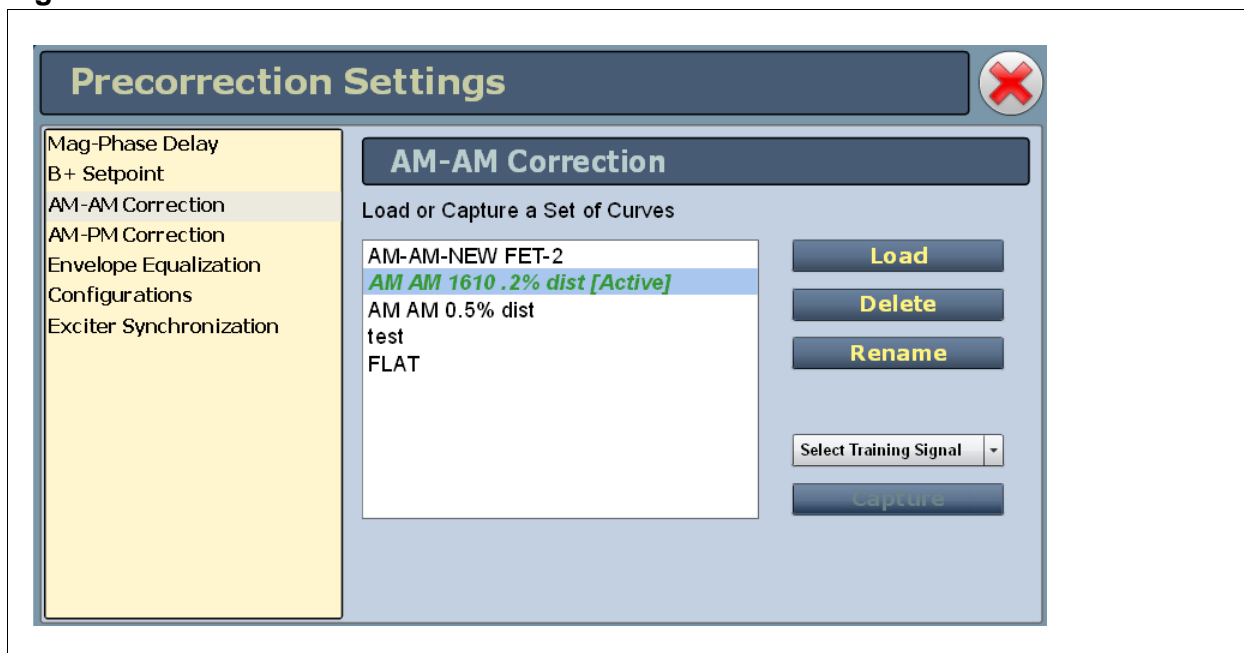

## AM-PM CORRECTION

The **AM-PM Correction** page (see [Figure 2.77](#)) allows you to load or capture a set of AM-PM correction curves. You can **Load** or **Delete** curves in this list; you can also capture a curve. When you select **Capture**, the AM-PM Correction instrument panel is displayed. Press **Done** to capture the curve, type a name for the curve, then press **Save** (or **Cancel**).

**CAUTION:**

Making changes to the AM-PM Correction curves automatically places the transmitter in analog AM mode, with full-scale sine-wave modulation. To avoid undesirable output or possible antenna damage, it is highly recommended that you perform these calibrations while operating the transmitter into a test load.

Value changes are not typically required.

AM-PM curves correct for a type of non-linearity where a change in input amplitude causes a change in phase. By applying a test signal and monitoring the output of the transmitter, the exciter will generate a table of values defining the required phase offset versus input signal level in an attempt to find the inverse curve to the AM-PM non-linearity, and provide a more linear amplifier. Applying the proper AM-PM correction will result in better spectral performance in digital modes of operation.

**Figure 2.77: Precorrection AM-PM**

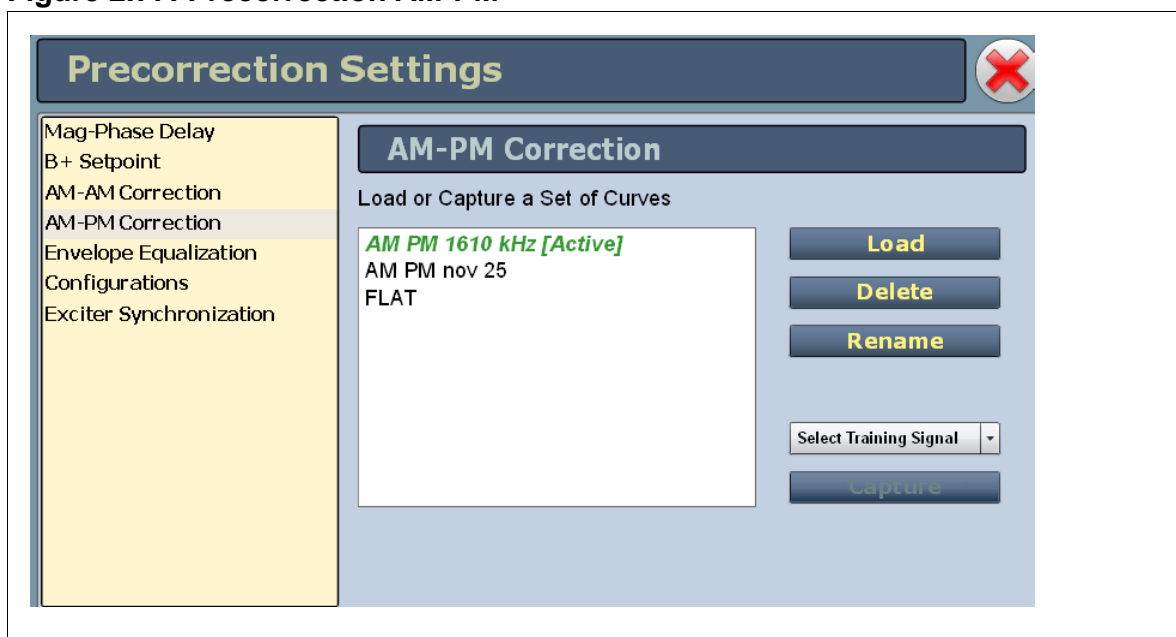

## ENVELOPE EQUALIZATION

The *Envelope Equalization* page (see [Figure 2.78](#)) allows you to load or capture a set of envelope equalization curves. You can **Load** or **Delete** curves in the list; you can also capture a curve. When you select **Capture**, the EQ Frequency Response window is displayed. Press **Done** to capture the curve, type a name for the curve, then press **Save** (or **Cancel**).



### CAUTION:

Selecting the Wide Band Noise training signal (see [Figure 2.78](#)) applies full-scale white noise modulation. To avoid undesirable output or possible antenna damage, it is highly recommended that you perform these calibrations while operating the transmitter into a test load.

Value changes are not typically required.

Envelope equalization curves correct for the frequency response of the magnitude path, dominated by the response of the modulator filter. By applying a test signal and monitoring the output of the transmitter, the exciter will use an LMS (Least Mean Squares) algorithm to generate a filter in an attempt to find a complementary response to the frequency response of the magnitude path (out to approximately 70 kHz). Applying the proper equalization curve will result in a flatter frequency response, and improved spectral performance in digital modes of operation, where the frequency content of the magnitude signal can be significant, as far out as 100 kHz..

**Figure 2.78: Precorrection Envelope Equalization**

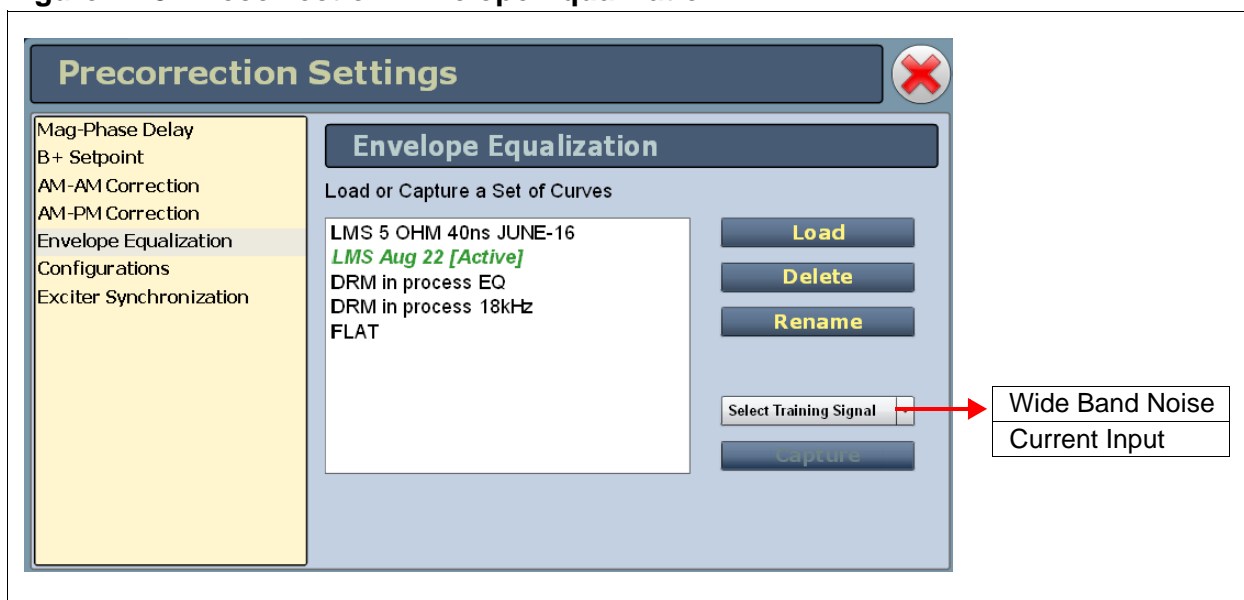



## CONFIGURATIONS

The **Configurations** page (see [Figure 2.79](#)) allows users to group the parameters that appear within the Precorrection Settings menu.

**Figure 2.79: Precorrection - Configurations**

The screenshot shows the 'Precorrection Settings' window with a sidebar on the left containing a tree view of settings: Mag-Phase Delay, B+ Setpoint, AM-AM Correction, AM-PM Correction, Envelope Equalization, Configurations (highlighted), and Exciter Synchronization. The main area is titled 'Configurations' and shows 'Current Settings [Active]' with a list: 'Default Config 1610 kHz' and 'DRM config'. To the right of this list are three buttons: 'Add', 'Edit', and 'Delete'. The 'Edit' button is highlighted with a red box. A red arrow points from the 'Edit' button to a 'Configuration Details' dialog box. Another red arrow points from the 'Add' button to the same dialog box. The dialog box contains the following fields:

Configuration Details	
Name	Current Config
Mag-Phase Delay	0.500 us
B+ Level	400 V
AM AM Curve	test
AM PM Curve	AM PM 1610 kHz
EQ Curve	LMS Aug 22
<input type="button" value="OK"/> <input type="button" value="Cancel"/>	

**Edit** button appears for local users in Local mode or for remote users in Remote mode.

**View** button appears otherwise (cannot edit in this case).

Once a configuration is created, it can be used in a preset. This allows the user to change the pre-correction settings based on the operating mode via the preset. Configurations are normally established at the factory, based on customer operating modes, and do not require adjustment.

Procedure to edit or create a configuration:

1. Select the **Configuration** option from the left side of the **Precorrection Settings** page to open a related window on the right side of the page.

2. Any existing configurations (e.g., Default Config 1610 kHz) will appear in the list. The active configuration, if applicable, is highlighted in green. You can view or edit existing configurations by pressing **Edit**, if available. You can also create a new configuration by pressing **Add** or remove a configuration by pressing **Delete**. You must have **Administrator** user account permission to edit, add or delete configurations.
3. If you press **Edit (View)** or **Add**, the **Configuration Details** window appears (see [Figure 2.79 on page 2-103](#)). In this screen you can enter or select the appropriate parameters for your desired configuration, including Name, Mag-Phase Delay, B+ Level, AM-AM Curve, AM-PM Curve and EQ Curve. When you are finished editing or creating the configuration, press **OK** to save the configuration or press **Cancel** to return to the **Pre correction Settings** page. Your new configuration should appear in the **Configurations** list.

Procedure to add a configuration to a preset:

1. Select the **Presets** option from the **Menu** page to open the **Presets** page.
2. Press the **Load** button to select the preset that you want to edit.
3. In the **General** tab, select the **Configuration** field's drop-down menu and select the desired configuration for that preset. Press **Save** to overwrite the existing preset or **Save New** to create a new preset. **NOTE:** you can edit a preset without making it active (see "[Presets - editing operational settings](#)", on page 2-48).

## EXCITER SYNCHRONIZATION

The *Exciter Synchronization* page (see Figure 2.80) displays correction curve and configuration settings stored on each exciter and allows users to synchronize the settings between exciters A and B.

When AM-AM correction, AM-PM correction and EQ curves and configurations are created, they are stored in the active exciter. It may be necessary to copy these settings to the standby exciter, or in some cases to an exciter that has been replaced.

**Figure 2.80: Precorrection - Exciter Synchronization**

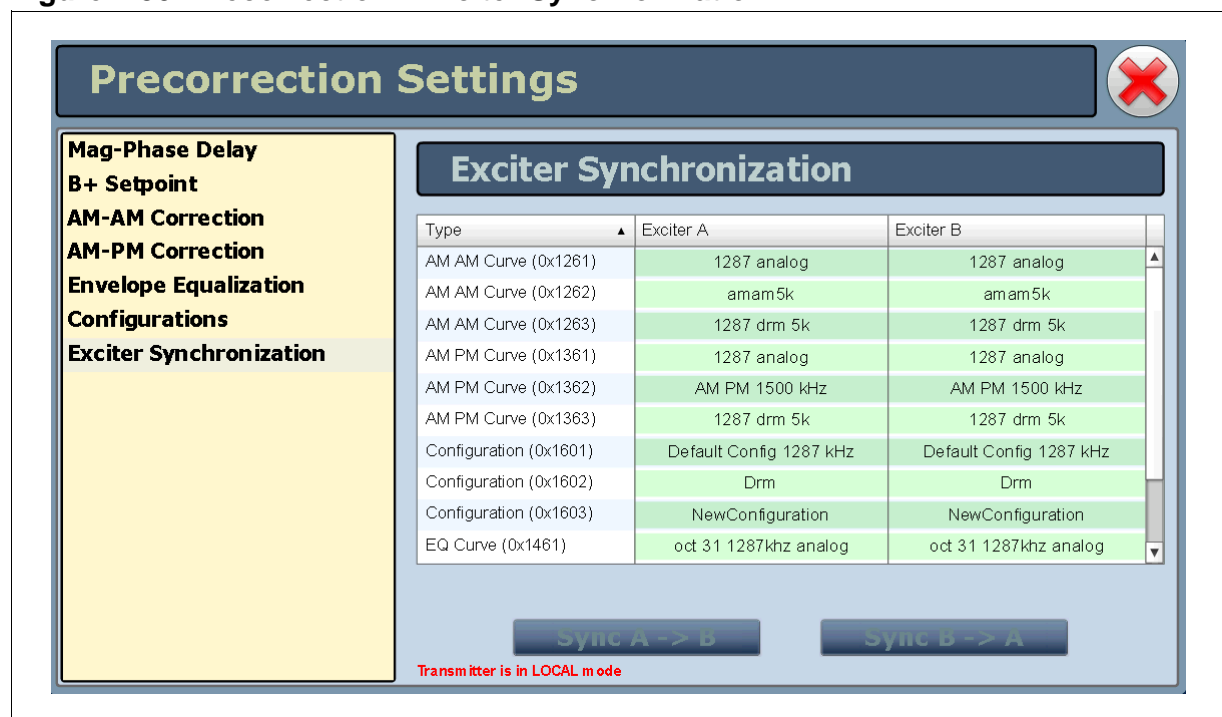

Items in green indicate the correction curve or configuration is identical for both exciter.

Items in red indicate a difference or a correction curve or configuration that is on one exciter only.

Press **Sync A -> B** to copy settings stored on exciter A to exciter B.

Press **Sync B -> A** to copy settings stored on exciter B to exciter A.

## CHANGEOVER PAGE - CHANGING EXCITER TRANSFER SETTINGS

The *Changeover* page (see [Figure 2.81](#)), accessed from the *Menu* page, allows control of exciter auto-changeover.

**Figure 2.81: Changeover Page**

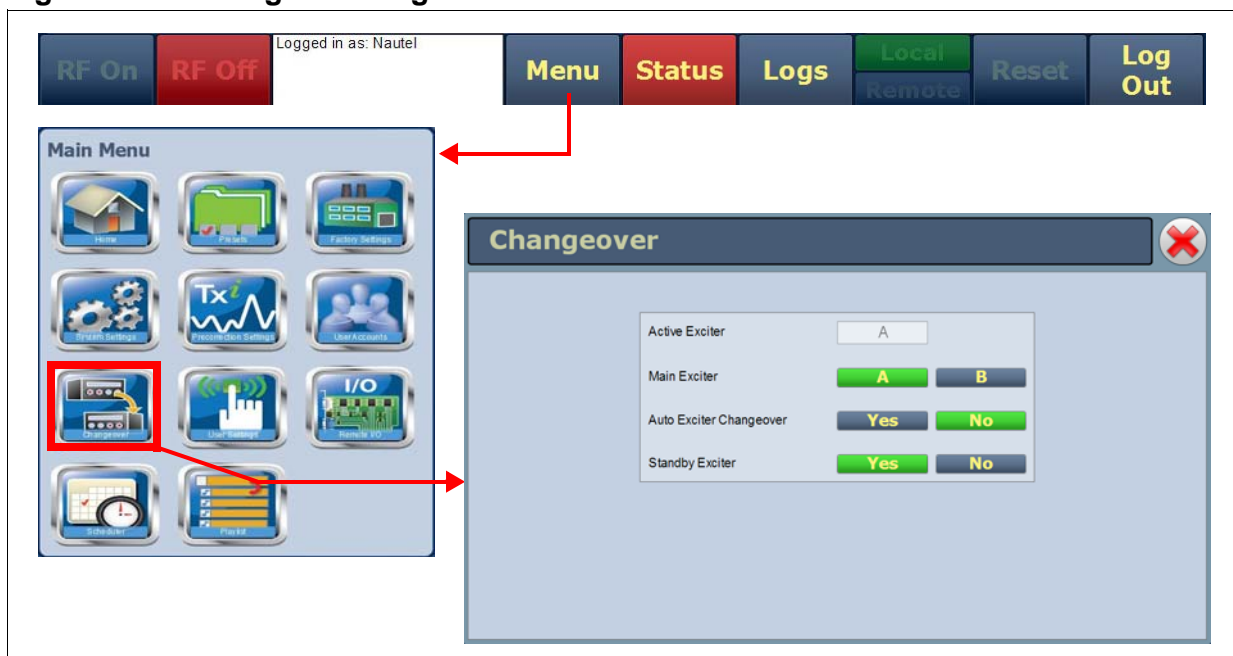

On this page, set the following exciter information:

- **Active Exciter** - indicates the exciter that is currently active.
- **Main Exciter** - indicates (in green) which exciter is considered to be the primary exciter. Select **A** or **B**. The default exciter is **A** if the **Standby Exciter** is set to **No**. **NOTE:** Changing the setting may change the active exciter.
- **Auto Exciter Changeover** - indicates (in green) if automatic exciter changeover is enabled. Select **Yes** if automatic changeover is desired or **No** if user selected changeover is desired. **NOTE:** you cannot change the setting if the **Standby Exciter** is set to **No**.
- **Standby Exciter** - identifies whether or not a standby exciter is available. This is factory set and only requires adjustment if an exciter is removed or not functional. **Yes** indicates that a standby operation is available or desired. **No** indicates that a standby operation is not available or desired.

## FACTORY SETTINGS

Values for critical parameters are set using the **Factory Settings** page (see [Figure 2.82](#)), which you access from the **Menu** page. To use this page, simply select an item from the list on the left-side of the page to open related information on the right side of the page.



**WARNING:** Factory settings are established at the factory and should not require any adjustment. These settings affect critical system protections. Making changes to these settings may void your warranty. Contact Nautel before making changes.

For future reference, record a parameter value before and after making a change.

This section includes the following topics:

- "Audio Inputs", on page 2-108
- "B+ Calibration", on page 2-109
- "Forward/Reflected Power", on page 2-110
- "RF Symmetry", on page 2-111
- "SWR Thresholds", on page 2-112
- "Transmitter Type", on page 2-113
- "Transmitter Frequency", on page 2-114
- "PDM Settings", on page 2-115

**Figure 2.82: Factory Settings Page**

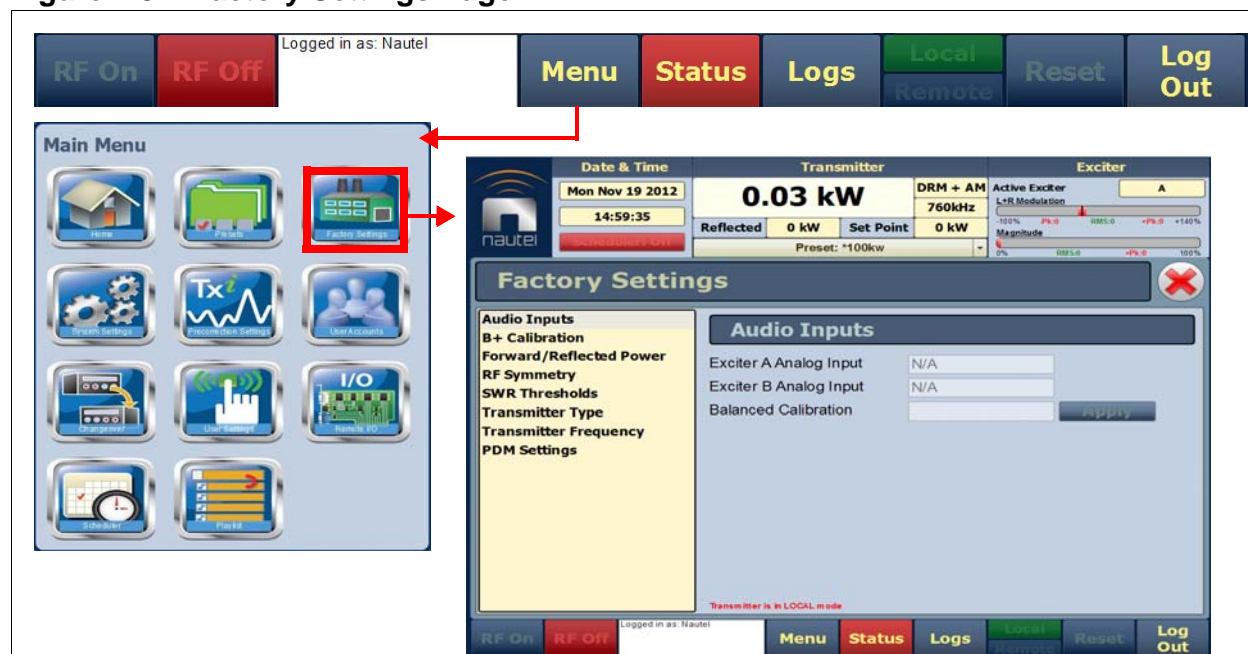

## AUDIO INPUTS

The **Audio Inputs** page (see [Figure 2.83](#)) displays the measured level of the Balanced Analog source (in dBm).

The balanced calibration field allows for establishing a reference from a known source.



**WARNING:** Factory settings are established at the factory and should not require any adjustment. These settings affect critical system protections. Making changes to these settings may void your warranty. Contact Nautel before making changes.

For future reference, record a parameter value before and after making a change.

**Figure 2.83: Factory Settings - Audio Inputs**

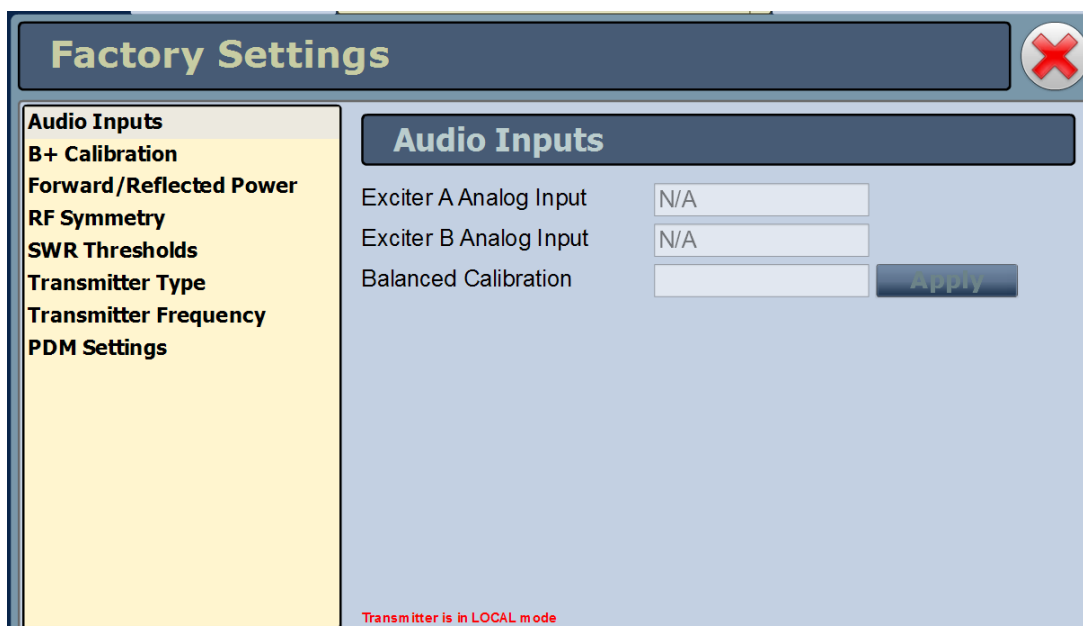

## B+ CALIBRATION

The **B+ Calibration** page (see [Figure 2.84](#)) displays the measured B+ levels, the B+ Limit Setpoint (high voltage alarm level; nominally 420 V) and a calibration box. The B+ calibration value allows you to enter a measured B+ voltage to calibrate the B+ based on an externally measured B+ level.



**WARNING:** Factory settings are established at the factory and should not require any adjustment. These settings affect critical system protections. Making changes to these settings may void your warranty. Contact Nautel before making changes.

For future reference, record a parameter value before and after making a change.

**Figure 2.84: Factory Settings - B+ Calibration**

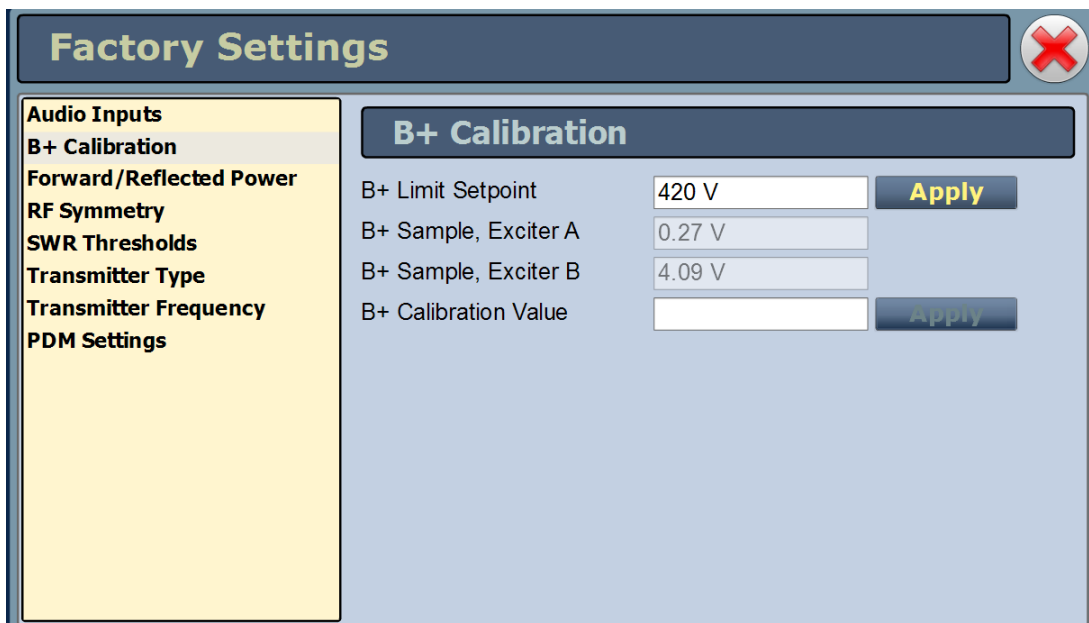

## FORWARD/REFLECTED POWER

The **Forward/Reflected Power** page (see [Figure 2.85](#)) allows the forward/reflected power to be calibrated based on the filter lag, the ideal PA impedance (magnitude and phase), the test load impedance and the measured RF current. Nautel sets these values at the factory. Value changes are not typically required unless you are performing a frequency change.



**WARNING:** Factory settings are established at the factory and should not require any adjustment. These settings affect critical system protections. Making changes to these settings may void your warranty. Contact Nautel before making changes.

For future reference, record a parameter value before and after making a change.

**Figure 2.85: Factory Settings - Forward/Reflected Power**

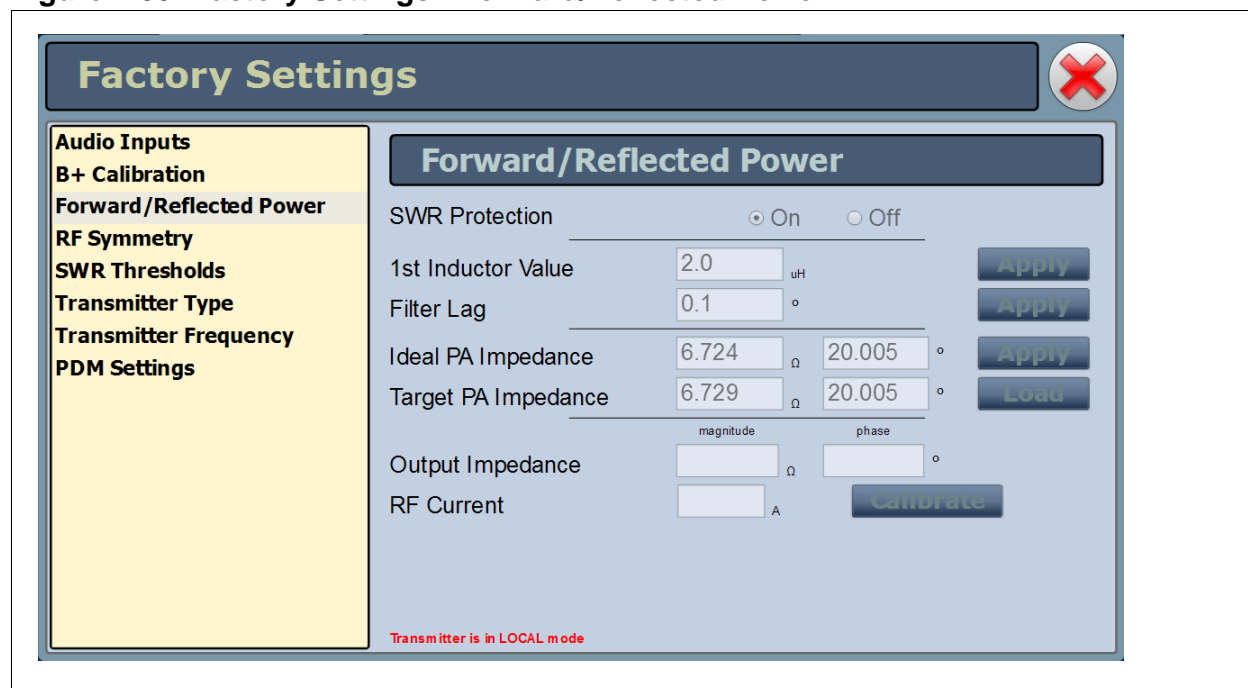



## RF SYMMETRY

The **RF Symmetry** page (see [Figure 2.86](#)) allows entering RF symmetry values for exciter A or B to attempt to minimize second harmonic content when operating on each exciter. Values are factory set and should not require adjustment.



**WARNING:** Factory settings are established at the factory and should not require any adjustment. These settings affect critical system protections. Making changes to these settings may void your warranty. Contact Nautel before making changes.

For future reference, record a parameter value before and after making a change.

**Figure 2.86: Factory Settings - RF Symmetry**

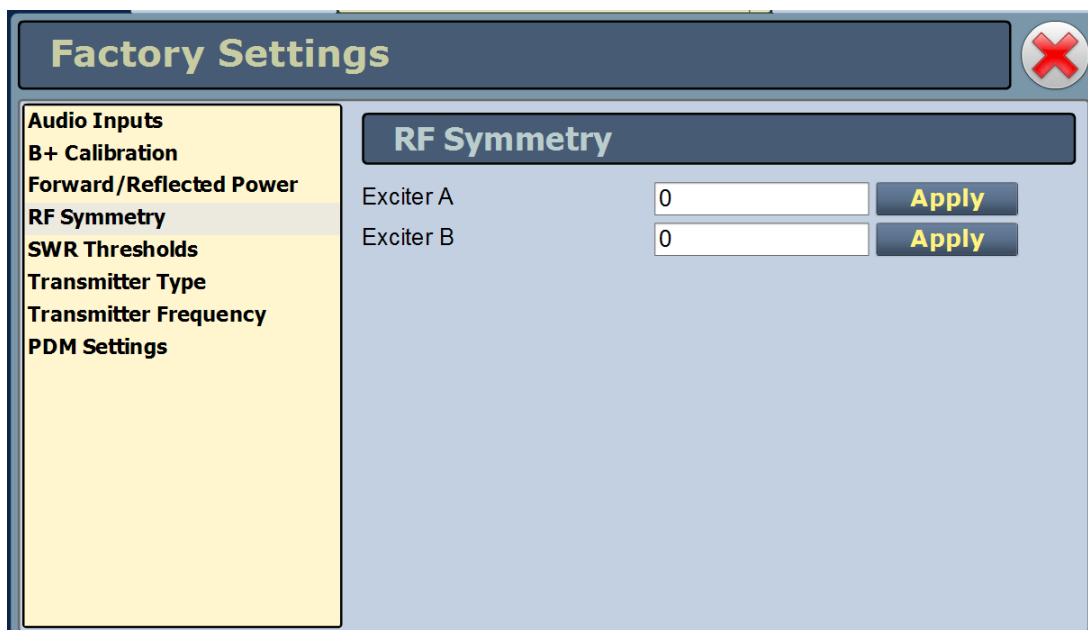

## SWR THRESHOLDS

The **SWR Thresholds** page (see [Figure 2.87](#)) displays the **Peak Reflected Limit**, **RMS Reflected Limit** and the **Peak RF Current Limit**. Value changes are not typically required.



**WARNING:** Factory settings are established at the factory and should not require any adjustment. These settings affect critical system protections. Making changes to these settings may void your warranty. Contact Nautel before making changes.

For future reference, record a parameter value before and after making a change.

**Figure 2.87: Factory Settings - SWR Thresholds**

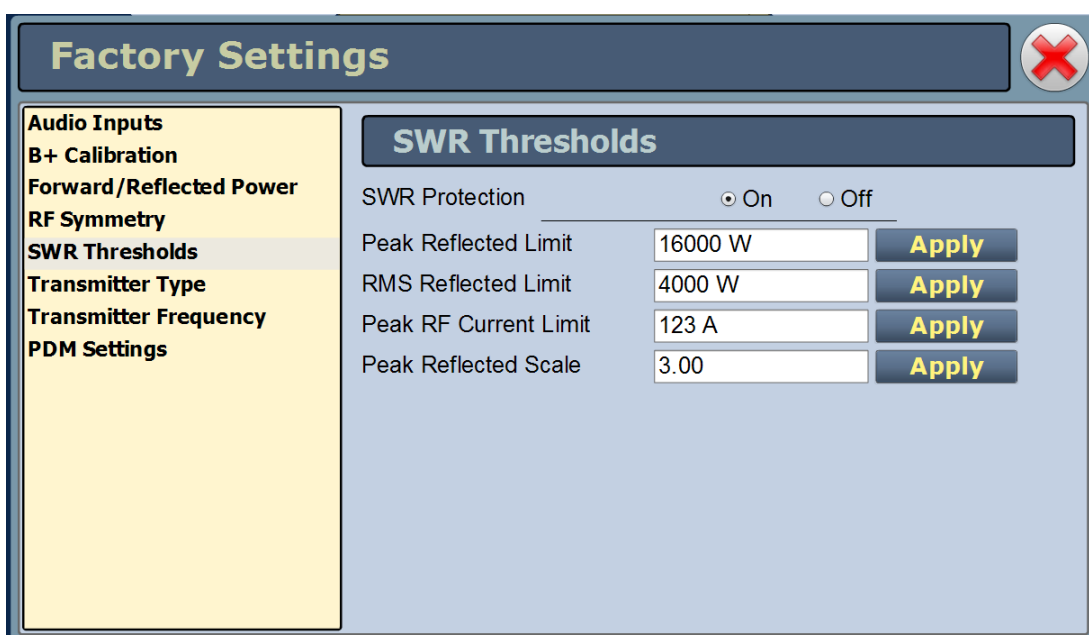

## TRANSMITTER TYPE

The *Transmitter Type* page (see [Figure 2.88](#)) displays the selected transmitter type. The selection is based on the power capacity of the transmitter and is set at the factory during testing.



**WARNING:** Factory settings are established at the factory and should not require any adjustment. These settings affect critical system protections. Making changes to these settings may void your warranty. Contact Nautel before making changes.

For future reference, record a parameter value before and after making a change.

**Figure 2.88: Factory Settings - Transmitter Type**

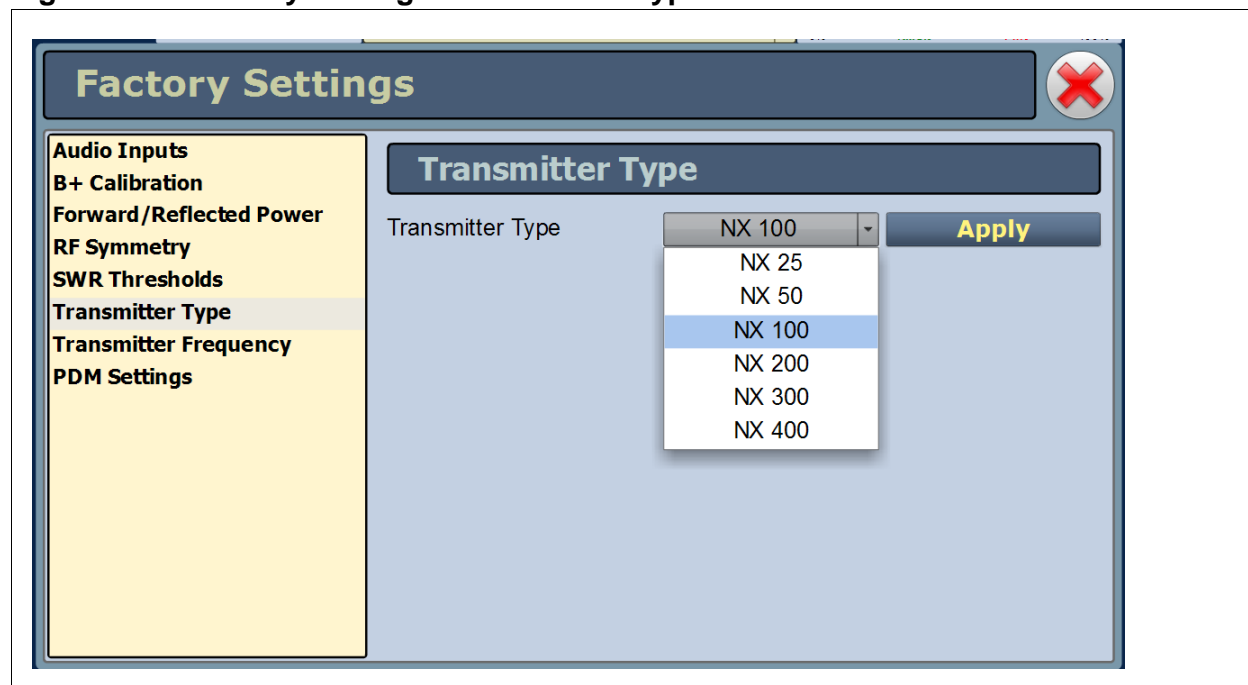

## TRANSMITTER FREQUENCY

The *Transmitter Frequency* page (see [Figure 2.89](#)) displays the precise carrier frequency of the transmitter. Do not change the carrier frequency unless you are performing a frequency change procedure.



**WARNING:** Factory settings are established at the factory and should not require any adjustment. These settings affect critical system protections. Making changes to these settings may void your warranty. Contact Nautel before making changes.

For future reference, record a parameter value before and after making a change.

**Figure 2.89: Factory Settings - Transmitter Frequency**

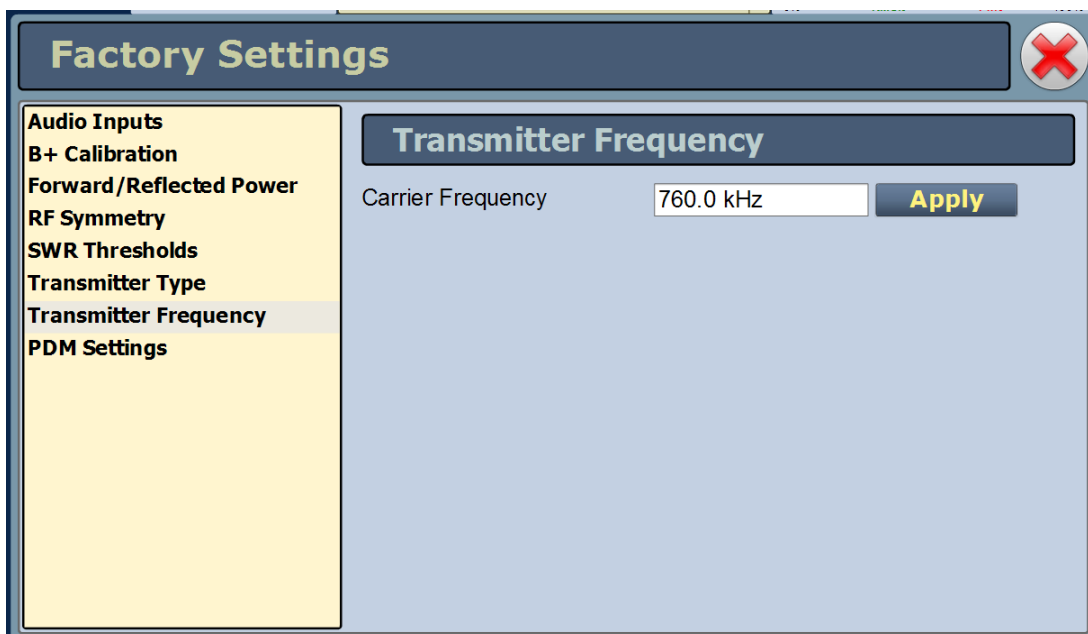

## PDM SETTINGS

The **PDM Settings** page (see [Figure 2.90](#)) displays the selected PDM settings. The selection is based on the PDM configuration of the transmitter and is set at the factory during product testing. **PDM Phase Calibration** may be required after replacing or moving RF power modules. See the “Replacing a Power Module” section of the *NX50 Troubleshooting Manual* for more information.



**WARNING:** Factory settings are established at the factory and should not require any adjustment. These settings affect critical system protections. Making changes to these settings may void your warranty. Contact Nautel before making changes.

For future reference, record a parameter value before and after making a change.

**Figure 2.90: Factory Settings - PDM Settings**

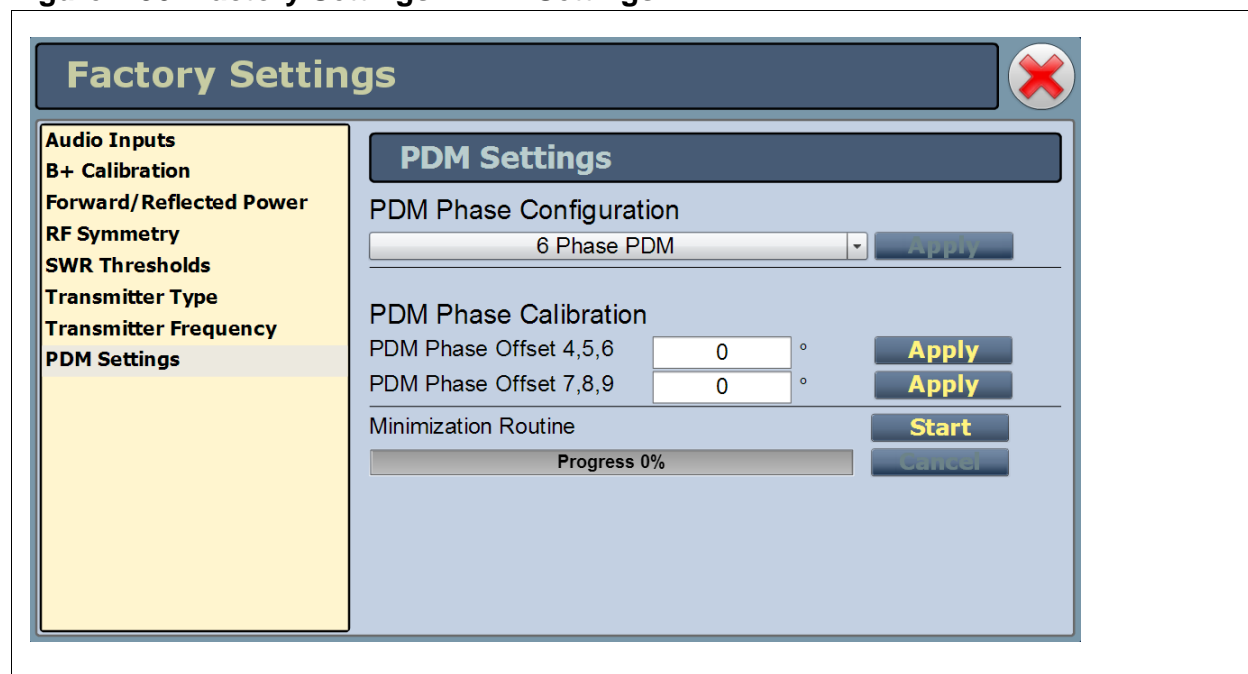

## REMOTE I/O PAGE

The *Remote I/O* page (see [Figure 2.91](#)), accessible from the *Menu* page, allows you to configure your remote input/output interface for the transmitter. Click X in the upper, right corner to close this page and return to the home page.

Refer also to the NX50 Pre-installation Manual for information on remote inputs and outputs and their factory default settings.

This section includes the following topics:

- "Digital inputs", on page 2-117
- "Digital outputs", on page 2-119

**Figure 2.91: Remote I/O Page**

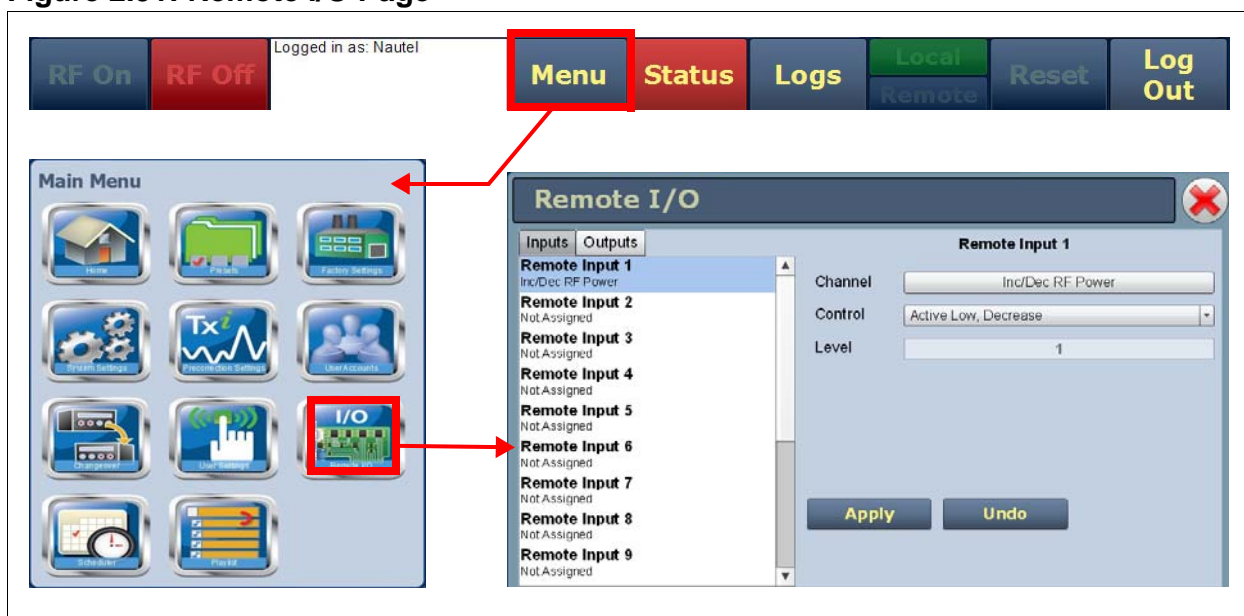

## DIGITAL INPUTS

In the **Remote I/O** page, use the **Inputs** tab parameters (see [Figure 2.92](#)) to configure up to 16 digital inputs that allow you to remotely control various operational characteristics of the transmitter.

Unless otherwise noted these inputs are only accepted by the transmitter if the **Remote/Local** status (bottom panel of any AUI page) is set to **Remote**. That setting can only be selected by a local user using the front panel AUI.

Nautel sets digital input defaults prior to shipping. See the *NX50 Pre-installation Manual* for details. If necessary, re-configure the digital inputs as follows:

**Figure 2.92: Remote I/O Input Parameters**

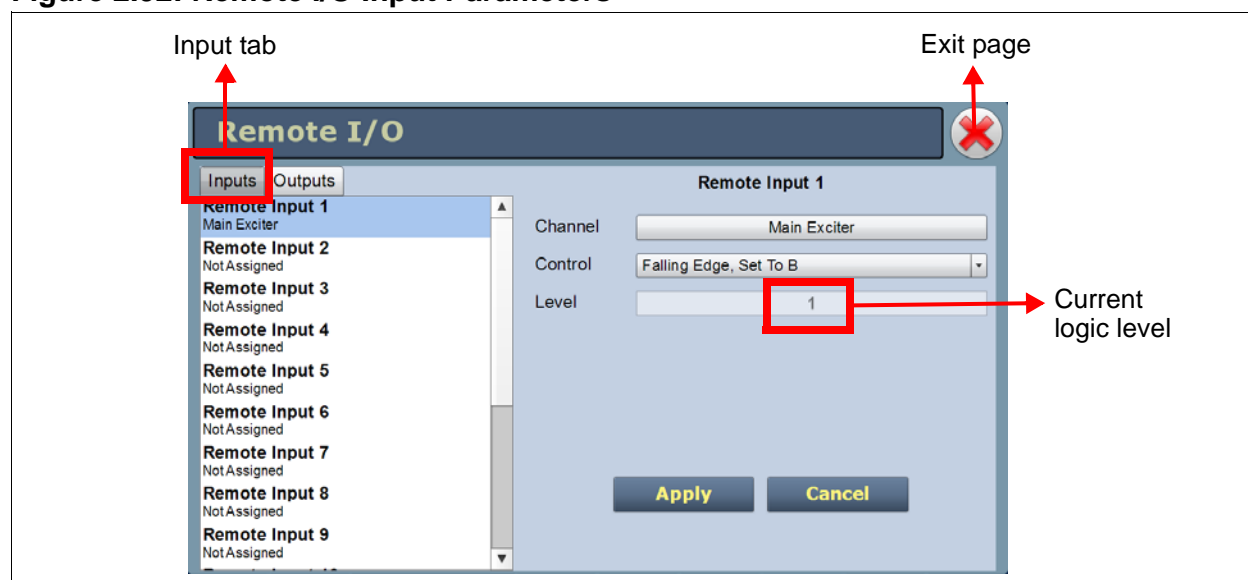

1. On the left side of the page, select the desired digital input (1 through 16) from the list. Note: you can configure digital inputs 1 through 16 for one of a variety of control inputs.
2. On the right side of the page, assign a name to the digital input by pressing the **Channel** bar and selecting one of the following options:
  - **Not Assigned** - has no effect on transmitter operation, regardless of logic level.
  - **RF On/Off** - tells the system to provide RF power, if possible (same as pressing the **RF On** or the **Rf Off** button on the AUI).
  - **Reset** - causes a system reset.
  - **Inc/Dec RF Power** - tells the system to increase (if possible) or decrease output carrier power.
  - **Main Exciter** - selects the main exciter to operate the transmitter.
  - **Auto Exciter Changeover** - sets the exciter changeover function to operate automatically.

- 
- **Scheduler On/Off**- enables/disables the automatic mode scheduler.
  - **Max Power Lockout 1 - 8** - selects the associated power lockout limit (1 - 8) as active (functions regardless of local/remote mode).
  - **Preset:** (name) - selects the appropriate operating preset as active.
3. The **Level** bar displays the input's current logic level (1 or 0).
  4. Configure the active/inactive control for each of the 16 digital inputs. Press the arrow beside the **Control** bar to display the following drop-down menu options:
    - **Rising Edge, Turn On/Reset/Set To A/Set To B.** Logic '1' (high or rising edge) activates the input (or causes a reset, as appropriate).
    - **Falling Edge, Turn On/Reset/Set To A/Set To B.** Logic '0' (low or trailing edge) activates the input (or causes a reset, as appropriate).
    - **Rising Edge, Turn Off.** Logic '1' (high or rising edge) de-activates the input.
    - **Falling Edge, Turn Off.** Logic '0' (low or trailing edge) de-activates the input.
    - **Falling Edge, Toggle.** Logic '0' (low or trailing edge) de-activates the input; next logic '0' (low or trailing edge) activates the input.
    - **Rising Edge, Toggle.** Logic '1' (high or rising edge) activates the input; next logic '1' (high or rising edge) de-activates the input.
    - **Rising Edge, Turn On/Set To B. Falling Edge Turn Off/Set To A.** Logic '1' (high or rising edge) activates the input; logic '0' (low or trailing edge) de-activates the input.
    - **Falling Edge, Turn On/Set To B. Rising Edge Turn Off/Set to A.** Logic '0' (low or trailing edge) activates the input; logic '1' (high or rising edge) de-activates the input.
    - **Active High, Increase.** Logic '1' (high) causes a power increase or turns on the feature.
    - **Active Low, Increase.** Logic '0' (low) causes a power increase.
    - **Active High, Decrease.** Logic '1' (high) causes a power decrease.
    - **Active Low, Decrease.** Logic '0' (low) causes a power decrease.
    - **Active High, Turn On.** Logic '1' (high) activates the input.
    - **Active Low, Turn On.** Logic '0' (low) activates the input.
  5. When the input settings are complete, press **Apply** to accept and activate these changes or press **Cancel** to cancel them and return to the previous settings.
  6. To exit the page, press **X** (top right).



## DIGITAL OUTPUTS

Using the parameters from the **Outputs** tab (see Figure 2.93), you can configure up to 16 digital outputs that indicate either the presence of various alarms or the status of operator controlled circuits.

Nautel sets digital output defaults prior to shipping. See the *NX50 Pre-installation Manual* for details. If necessary, re-configure the digital outputs as follows:

**Figure 2.93: Remote I/O - Output Parameters**

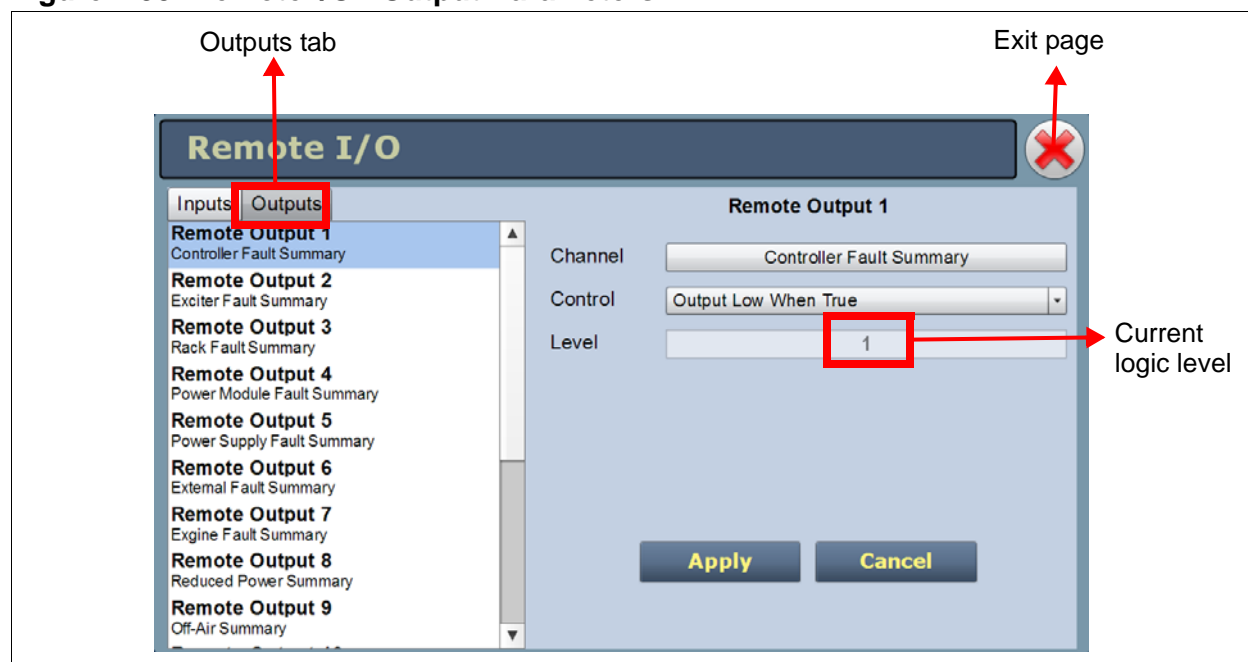

1. On the left side of the page, select the desired digital output (1 through 16) from the list. Note: you can configure digital outputs 1 through 16 for one of a variety of monitoring outputs.
2. On the right side of the page, assign a name to the digital output by pressing **Channel** and selecting one of the following options:
  - **Not Assigned** - No alarm or status parameter is monitored.
  - **Local/Remote** - Active logic level indicates the transmitter is in local control. Inactive logic level indicates the transmitter is in remote control.
  - **RF On/Off** - Active logic level indicates the transmitter's RF power stage is on (enabled). Inactive logic level indicates the transmitter's RF power stage is off.
  - **Active Exciter** - Active logic level indicates that exciter A is active. Inactive logic level indicates that exciter B is active.

- **Auto Exciter Changeover** - Active logic level indicates that the automatic exciter change-over function is enabled.
  - **Main Exciter** - Active logic level indicates that exciter A is selected as the main exciter. Inactive logic level indicates that exciter B is selected as the main exciter.
  - **Scheduler On/Off**- Active logic level indicates that the automatic mode scheduler is enabled or disabled.
  - **Various Alarms** - Active logic level indicates that the selected alarm is occurring. Any transmitter alarm can be selected as a digital output. Refer to the NX50 Troubleshooting Manual for a description of each alarm.
  - **AUI Watchdog** - Active logic level indicates that a watchdog reset is occurring, due to an error in communication between the Controller and the single-board computer. The reset is configured using the AUI's **User Settings** page.
    - \* **Reset Immediately**: Reset will occur immediately after a communications error.
    - \* **Disable Reset**: No reset will occur.
    - \* **Custom Delay (default setting)**: Reset will occur after a communications error, but after a user-defined delay. If selected enter the delay, in minutes (factory set to 2 minutes).
  - **Max Power Lockout 1 - 8** - Active logic level indicates that a power lockout has been enabled, either through the AUI's **System Settings** page or by a remote digital input.
  - **Preset: (name)** - Active logic level indicates that the associated preset is active.
  - **Invalid Preset** - Active logic level indicates the current active preset is not a saved preset.
  - **Remote Input** - Mimics the logic of the associated remote input selection. Example: If Remote Output 5 is set to Remote Input, it will mimic the logic received on remote input pin 5. This is typically used for debugging remote inputs.
3. The **Level** bar displays the input's current logic level (1 or 0).
  4. Configure the active/inactive control for each of the 16 digital outputs. Press the arrow beside the **Control** bar to display the drop-down menu options that are appropriate for the selected Channel.

*Example:* if the selected channel is **RF On/Off**, the drop-down options are:

    - **Output Low When RF Off** - Logic '0' (low) indicates the output is true (RF is off); Logic '1' (high) indicates the output is false (RF is on).
    - **Output Low When RF On** - Logic '0' (low) indicates the output is true (RF is on); Logic '1' (high) indicates the output is false (RF is off).
  5. Press the **Level** bar and select **1** or **0** as the logic level.
  6. When the output settings are complete, press **Apply** to accept and activate these changes or press **Cancel** to cancel them and return to the previous settings.
  7. To exit the page, press **X** (top right).

## PLAYLIST MANAGER

The built-in audio player (see [Figure 2.94](#)) can use a file playlist, Livewire or Icecast as an audio source. These sources must be configured before they can be used. This section describes how to configure audio player sources. To view the *Playlist Manager* page, select **Playlist** from the *Menu* page options.

Using the audio player in the NX50 requires the installation of the optional USB sound card. This converts the streamed audio to a USB port on the single-board computer (SBC) to an AES stream that can be connected to an AES input on the control card.

The *Playlist Manager* page has two selectable tabs:

- "Playlist", on page 2-122
- "Streams", on page 2-124

**Figure 2.94: Playlist Manager page - Playlist tab shown**

The screenshot displays the 'Playlist Manager' interface. At the top, there are three main sections: 'Date & Time' (Wed May 16 2012, 13:44:34, Scheduler: On), 'Transmitter Configuration' (0 kW, 107.7 MHz, Reflected 0 W, Set Point 11.00 kW, Preset: Preset 3), and 'Exciter' (Active Exciter A, FM Modulation 8.99%). Below this is the 'Playlist Manager' title bar with a close button. The main area has two tabs: 'Playlists' and 'Streams'. A 'Manage Files' button is present. The 'Playlists' tab shows a table with one entry: 'Test Playlist'. The 'Streams' tab shows a table with columns for '#', 'Path', and 'Available Files on USB'. The 'Available Files on USB' section lists several MP3 files, including tracks by Mumford and Sons and Avicii. At the bottom, there are buttons for 'Add', 'Delete', 'Insert JMP', and 'Delete' for the playlist, and 'Add File' and 'Refresh' for the file list. The footer includes 'RF On/Off' status, 'Logged in as: Nautel', and navigation buttons for 'Menu', 'Status', 'Logs', 'Local/Remote', 'Reset', and 'Log Out'.

---

The playlist (or Icecast/Livewire stream) is typically used as an audio loss backup. For example, the user may operate with Preset 1 using one of the standard audio sources. Preset 1 can be configured to switch to another preset (e.g., Preset 2), which uses a playlist or stream, if Preset 1 loses its audio.

Playlist/stream presets can also be activated by the Scheduler (see "[Preset Scheduler](#)", on page 2-61).

## PLAYLIST

The **Playlist** tab (see [Figure 2.95](#)) displays the audio files and sequence that currently make up the playlist. Only audio files that are supported (e.g., .wav or .mp3 files) will be played. For .mp3 files, using files with bit rates equal to or greater than 96 kbps achieves best audio results. Also, you must have the optional USB sound card installed and activate a preset that has **Audio Player/AES1 or AES2** selected in the **Analog Settings** -> **AM Source** in the **Presets** page. There are three sections in the Playlist tab - Playlists, Playlist Contents and Available Files on USB.

**NOTE:** You should not change an active (playing) playlist nor should you attempt to delete or move a song that is currently playing. To make changes to the playlist, the audio player must be off (inactive), or at least not being used as the active preset's source.

The **Playlists** section is used for adding (**Add** button) and deleting (**Delete** button) playlists.

The **Playlist Contents** section is used for inserting jumps (**Insert JMP** button) and deleting playlist contents (**Delete** button). The **Insert JMP** button allows the user to set up a playlist that can jump to an item in another playlist. You can drag files up and down the **Playlist Contents** list and you can drag files from the **Available Files on USB** list to the **Playlist Contents** list.

The **Available Files on USB** section is used for adding audio files to the playlist (**Add Files** button) or refreshing the available files list (**Refresh** button). Audio files must be stored on an external USB device; they are not stored in the transmitter. Only the audio files stored in the root directory of the most recently connected USB device appear on the playlist. The list will be empty if no USB device is connected. The USB drive must be formatted with a FAT32 file system. Click the **Refresh** button to force an update of the list of files on the mounted USB.

**NOTE:** MPEG Layer-3 audio coding technology licensed from Fraunhofer IIS and Thomson.

The audio player supports only one USB device at a time. If multiple USB devices are connected, only the most recently connected USB is recognized as the active USB drive. If multiple USB devices are connected and one is removed, both devices are unmounted.

The **Manage Files** button, available on the remote AUI only, displays a pop-up window that allows the user to **Browse** for files and **Upload** them to the USB or **Delete** them from the USB. You should not delete files that are part of more than one playlist.

Figure 2.95: Managing Playlist files

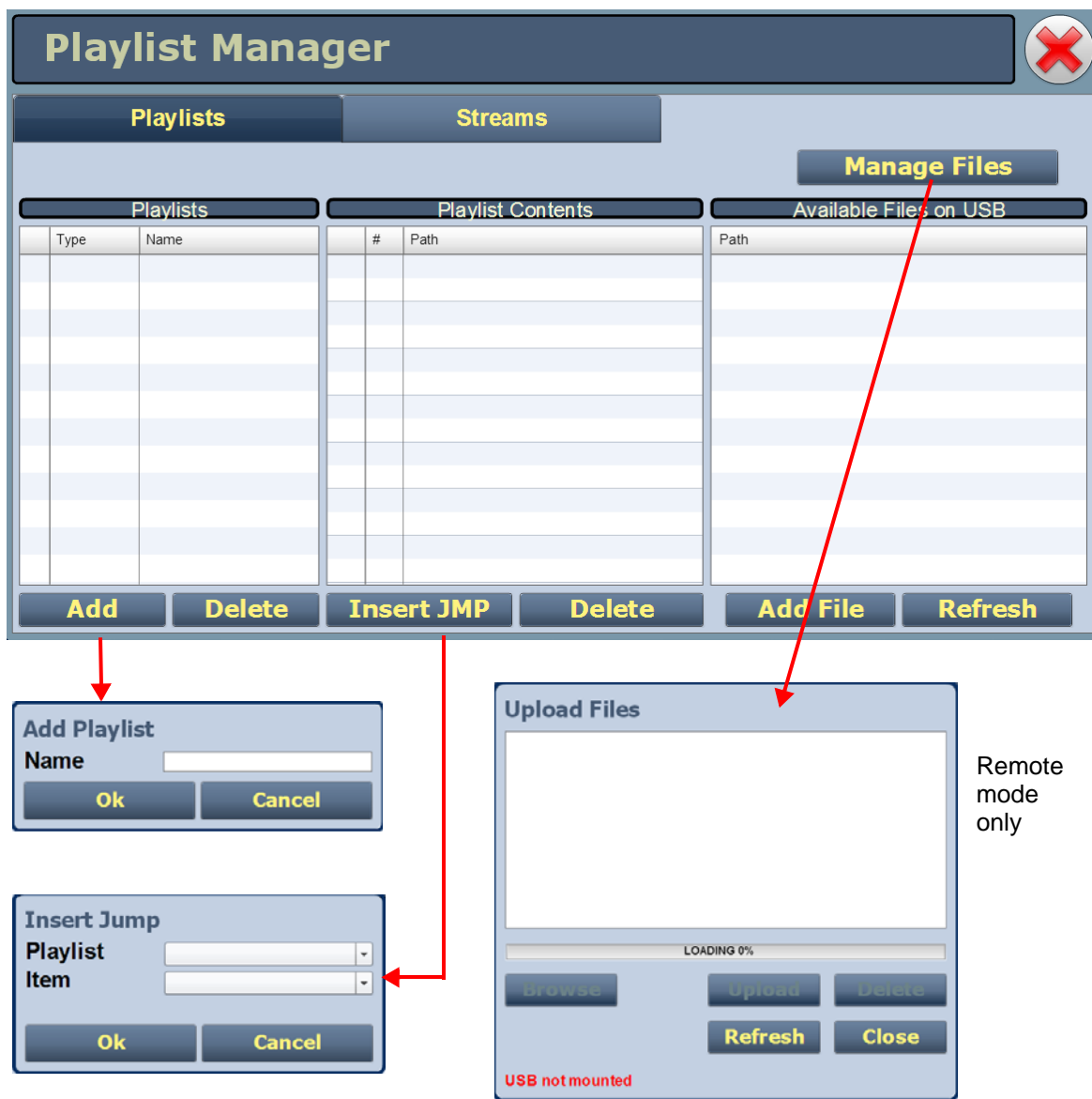

## STREAMS

The NX50 is capable of playing audio streams in either Icecast or Shoutcast format.

The audio player supports Icecast/Shoutcast playlists and IP addresses for audio streams. For an Icecast/Shoutcast playlist enter the URL for the station. For an audio stream, enter the URL for that stream.

**Figure 2.96: Playlist Manager page - Streams tab**

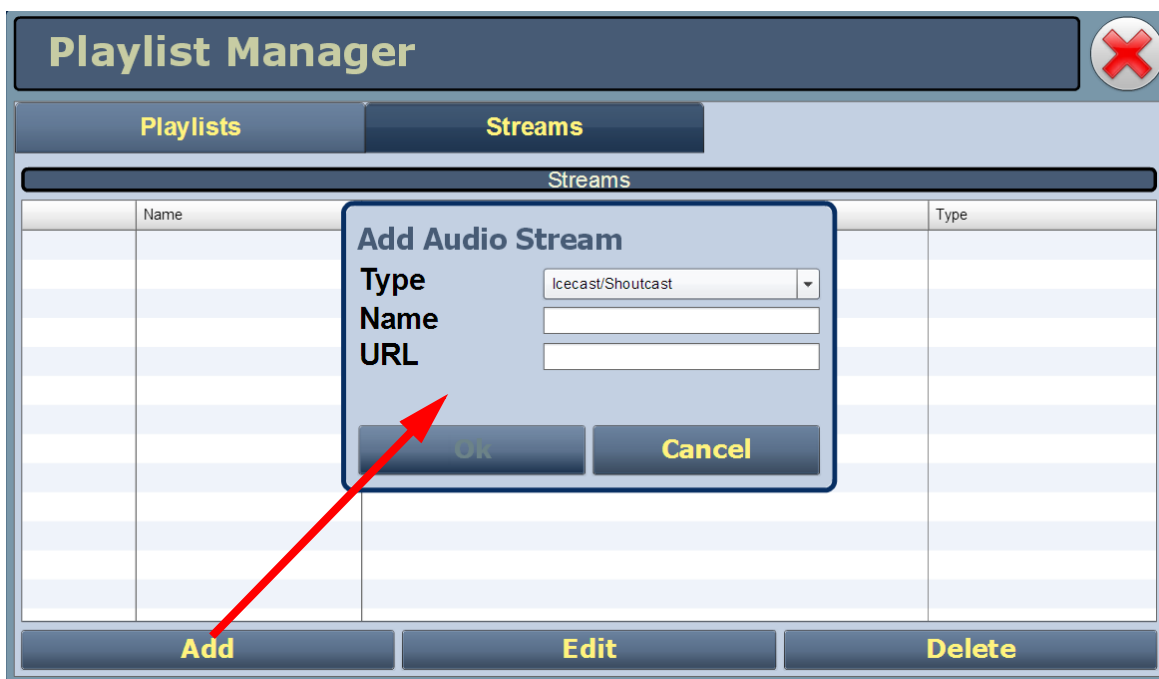

### ADDING AN AUDIO STREAM

1. From the **Streams** tab (see [Figure](#) ), click the **Add** button.
2. Use the drop-down menu to select the desired **Type** of audio stream (only **Icecast/Shoutcast** is available).
3. Enter the appropriate information for the audio server (Name and URL). Make sure the NX50 can access the location.
4. Click **OK** to add the audio stream or click **Cancel** to discard changes.

**EDITING OR DELETING AN AUDIO STREAM**

1. From the **Streams** tab (see [Figure 2.96 on page 2-124](#)), select the desired audio stream from the list. Click the **Edit** button to modify the audio stream or the **Delete** button to remove the audio stream.
2. If you are editing an audio stream, enter the appropriate information for the audio server (Name and URL for Icecast/Shoutcast). Make sure the NX50 can access the location.
3. Click **OK** to either edit or delete the audio stream, or click **Cancel** to discard changes.

## USING THE SAFETY INTERLOCK SWITCH

A key controlled safety interlock switch box (see [Figure 2.97 on page 2-127](#)) is provided with the NX50 transmitter to ensure operator safety. The transmitter's rear door must be closed and locked before ac power to the transmitter can be turned on. Similarly, ac power must be turned off before the rear door can be opened.

## OPENING THE TRANSMITTER'S REAR DOOR

Follow these steps to gain access to the rear of the transmitter:

1. Move the safety interlock switch to the **OFF** position. This allows the **SERVICE KEY** to be moved. Turn the **SERVICE KEY** clockwise to the **OFF** position and remove the key from the safety interlock switch box. When the **SERVICE KEY** is removed, the safety interlock switch is locked in the **OFF** position.
2. Insert the **SERVICE KEY** into the key hole in the handle of the transmitter's rear door and turn the key clockwise.
3. Open the rear door of the transmitter.

## APPLYING AC POWER TO THE TRANSMITTER

Follow these steps to close the transmitter and apply ac power:

1. Close and latch the transmitter's rear door. Turn the **SERVICE KEY** counter clockwise to lock the door. Remove the **SERVICE KEY**.
2. Insert the **SERVICE KEY** into the safety interlock switch box's key hole and turn the key counter clockwise to the **ON** position. Move the safety interlock switch to the **ON** position to apply ac power to the transmitter.



**Figure 2.97: Safety Interlock Switch Operation**

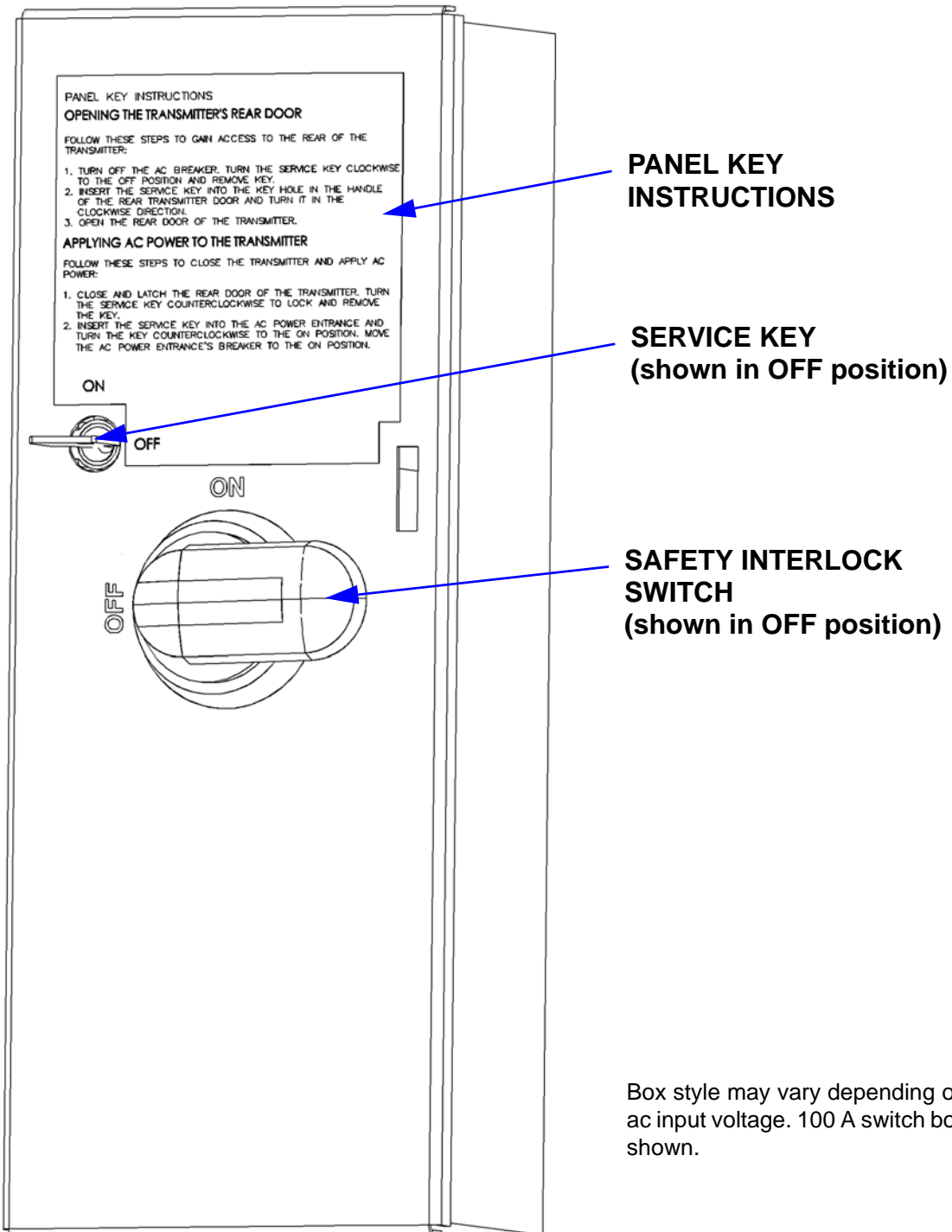



---

## SECTION 3: ROUTINE MAINTENANCE

This section provides instructions for performing routine maintenance on the NX50 transmitter. This section includes the following topics:

- [Scheduled maintenance](#)
- [Replacing a damaged air filter - see page 3-2](#)
- [Performing on-air checks - see page 3-3](#)
- [Replacing the control/interface PWB battery - see page 3-4](#)
- [Inspecting lightning protection systems - see page 3-5](#)

---

### SCHEDULED MAINTENANCE

Scheduled maintenance consists of performing a visual inspection of the NX50 at scheduled intervals. The recommended minimum time between scheduled maintenance visits is three months. Local operating and environmental conditions may dictate more frequent visits, while in remote sites less frequent visits may be acceptable. Experience and system reliability will determine the most practical schedule for a specific installation.

### CLEANING

At a minimum, follow the cleaning procedures listed below.



*Note:*

*A site located in a dirty area using open-air cooling requires more extensive cleaning than a site located in a clean area using closed-air cooling.*

1. Clean the air filters, noting there is one in the back of each cabinet. Remove the air filters, rinse them with water, spray them with Handi-Koter filter coat (Nautel Part # HQ59, located in the ancillary kit), then re-install the air filters. If an air filter becomes damaged, replace it as soon as possible. See [“Replacing a damaged air filter” on page 3-2](#).
2. Clean the NX50 using a vacuum cleaner and a soft-bristle brush to remove loose dirt. Clean, damp rags should be used to remove dirt that cannot be removed with a vacuum cleaner. Never use compressed air to clean the NX50.

## CHECKING HARDWARE

All hardware must be checked at least once a year. Thermal cycling from turning the NX50 on and off will require more frequent checks.

- To prevent damaging the hardware, ensure that the proper sized tools are used. In most cases, hardware is metric.
- A mounting surface or terminal that has changed colour indicates a loose hardware connection.
- Multi-stranded cables installed on terminal strips must be retorqued.

## BATTERY REPLACEMENT

The NX50's control/interface PWB contains a battery backup circuit that provides a memory of alarm occurrences during ac power failure. See [“Replacing the control/interface PWB battery” on page 3-4.](#)

---

## REPLACING A DAMAGED AIR FILTER

If an air filter becomes damaged, replace it as follows:

### INTERVAL

As required.

### PARTS AND TOOLS

Replacement air filter and filter coat spray.

### PROCEDURE

Take the following steps to replace an NX50 air filter:

1. Order a new filter and filter coat spray, as necessary. You can order a standard sized filter from Nautel (Nautel Part # HR111) or from the manufacturer (Research Products, EZ Kleen filter # 9151) or obtain one from any local supplier of HVAC supplies.
2. Order new filter coat spray, if necessary. You can order replacement filter coat from Nautel (Nautel Part # HQ59) or from the manufacturer (Research Products Handi-Koter adhesive spray bottle # 412) or obtain it from any local supplier of HVAC supplies.

3. Unpack the new filter and inspect it for damage.
  4. Remove the old filter.
  5. Apply filter coat spray (originally supplied with the transmitter) to the replacement filter.
  6. Insert the new air filter into the bracket, with the sprayed side facing you.
  7. Dispose of the damaged air filter.
- 

## PERFORMING ON-AIR CHECKS

You should check the on-air quality of the transmitter's signal periodically. This check can be done locally at the transmitter site, or remotely from another location in the transmitter's coverage area.

### INTERVAL

Every 12 months, or as required by law.

### PARTS AND TOOLS

- High-quality receiver compatible with the modulation scheme used on the transmitter.

### PROCEDURE

1. Monitor the transmitter signal to identify any problems:
  - Use a high quality receiver to monitor audio quality.
  - Check the spectral output of the transmitter using the front panel AUI's spectrum analyzer.
  - Take a portable receiver to different locations in your coverage areas to identify any problems with the antenna pattern or areas of localized interference.

## REPLACING THE CONTROL/INTERFACE PWB BATTERY

Replace the battery on the control/interface PWB once a year, or whenever the **Controller - Low Battery** alarm appears (on the AUI or via digital output). Chemical leakage from an old battery can cause damage. Also, the control/interface PWB's microcontroller may not retain its settings if ac power is turned off while the backup battery power is low. The battery should be replaced while ac power is applied to the transmitter.

### INTERVAL

Every 12 months.

### PARTS AND TOOLS

Replacement battery. 3 V lithium coin cell, 20 mm (Nautel Part # BBLT01, Panasonic # Panasonic CR2032).

### PROCEDURE

Perform the following steps to replace the battery:

1. Ensure ac power is being applied to the transmitter.
2. Open the front door of the control cabinet (A1).
3. Replace the battery in XBT1 on the control/interface PWB, noting the control/interface PWB is located on the control/exciter panel (A1A11) behind the front door. See Figures MD-5 and MD-6 in the mechanical drawings section at the end of the *NX50 Troubleshooting Manual*.
4. Close the front door.
5. Check for any alarms on the AUI. (See [“Viewing transmitter status”](#) on page 2-20.)

## INSPECTING LIGHTNING PROTECTION SYSTEMS

You should inspect the lightning protection systems that are connected to your NX50 transmitter, ac power, RF feedline, antenna and tower periodically to ensure that your site, equipment and personnel are fully protected.

### INTERVAL

Every 6 months.

### PARTS AND TOOLS

Depends on your site, but may include a DVM, ladder, binoculars, and continuity tester.

### PROCEDURE

Perform the following steps to test the lightning protection systems:

1. Test the continuity between ground available at your lightning arrestor and ground available on various pieces of equipment connected to the transmitter. Ensure that there is no resistance (0 ohms).
2. Physically inspect the lightning arrestor to ensure that all connections are tight. Also look for any sign of scoring or burning (indications of possible damage from earlier lightning strikes).
3. Using binoculars, visually inspect the hardware on the tower. Look for charred, broken or frayed connections and corrosion.





---

## SECTION 4: NON-STANDARD MAINTENANCE

This section provides instructions for performing non-standard maintenance on the NX50 transmitter. This section includes the following topics:

- [Upgrading software](#)

---

### UPGRADING SOFTWARE

Periodically, enhancements or improvements to the operating system are identified and made available. Perform a software upgrade as follows:

#### INTERVAL

As required.

#### PARTS AND TOOLS

- Laptop (i.e., local computer for direct connection) or network computer with Windows and Internet Explorer Web browser
- CAT5 Ethernet cable
- Upgrade software (\*.tgz file), provided via email, web download or flash card

#### PRELIMINARY CHECKS

1. Determine the current software revision installed. Via the advanced user interface (AUI) screen, go to **Menu/System Settings/Upgrade Software**. Select the \*.tgz file in the Select Upgrade File list (should highlight in blue) and click **Details**. Note the current software revision for Audio Player, AUI, Controller, Exciter, Rack and Cube.
2. Contact Nautel for the most recent software revision and download \*.tgz file to a laptop or network location.

---

## TRANSFERRING UPGRADE FILE

The following steps assume either the laptop will be used to connect directly to the transmitter OR the transmitter and network computer are currently connected to the same network.

### TRANSMITTER IP CONFIGURATION

1. From the transmitter AUI, go to **Menu -> User Settings -> Network Setup**.
2. Record your current network settings (IP Address, Subnet Mask, Default Gateway).
3. If connecting to the transmitter directly with a laptop, you must set a static IP address. This can only be done via the AUI. In the **Network Setup** page, set as follows:
  - Press the Static IP radio button to disable DHCP
  - IP Address: 10.10.10.2
  - Netmask: 255.255.255.0
4. Set the transmitter for **Remote** control.

### LAPTOP IP SETUP

The following steps assume the operating system is Windows XP. Adapt as required for computers with different operating systems.

1. On the laptop go to **Start Menu/Control Panel/Network Connections/Local Area Network**.
2. In the Local Area Network Status, open the **General** tab and choose **Properties**. Scroll down and highlight **Internet Protocol (TCP/IP)**. Choose **Properties**.
3. In the Internet Protocol (TCP/IP) Properties window, select **Use the following IP address**.
4. Enter the following settings:
  - IP Address: 10.10.10.1
  - Subnet Mask: 255.255.255.0
  - Default Gateway: 192.168.1.2
5. In the Internet Protocol (TCP/IP) Properties window, select **OK**.

6. In the Local Area Connection Properties window, select **OK**.
7. In the Local Area Connection Status window, select **Close**.
8. Close the Network Connections window.

### TRANSFER SOFTWARE UPGRADE FILE TO TRANSMITTER

1. If using a laptop, connect the laptop network interface card to J1 of the SBC's motherboard (A1U1) on the back of the control cabinet's front door using a CAT5 Ethernet cable. Open Internet Explorer and search for 10.10.10.2. The transmitter login screen should appear.
2. If using a network computer, open Internet Explorer and search for the IP address recorded in [Step 2 of "Transmitter IP Configuration" on page 4-2](#). The transmitter login screen should appear.
3. At the transmitter login screen enter:
  - User: "Nautel" or "\*\*\*\*", where \*\*\*\* is the user assigned user name
  - Password: leave blank (default) or "\*\*\*\*", where \*\*\*\* is the user assigned password
4. Navigate through the AUI to **Menu -> System Settings -> Upgrade Software**, select the **Manage Files** button and press **Browse**. Locate the software update \*.tgz file stored on the laptop or network computer, and press **Upload** to load the file into the transmitter upload file list. Allow this operation to complete.

### INSTALLING NEW SOFTWARE

1. Set the transmitter to **RF Off** and for **Remote** control. If the transmitter is already in **Remote** control mode, turn off the transmitter using the AUI on the laptop. Perform the following steps remotely using the AUI on the laptop.
2. Go to the AUI **Menu -> System Settings -> Upgrade Software** screen and select the update \*.tgz file from the Select Upgrade File list (should highlight in blue) and press **Start Upgrade**.

**CAUTION!** Do not leave this page until the flash process is complete.

3. After a successful load (status is 100% complete and a message indicates a successful load), cycle the ac power (turn off, then on) on the NX50.

4. This completes the software upgrade. Restore the former network settings on the transmitter and laptop as required (see [Step 2](#) of “[Transmitter IP Configuration](#)” on page 4-2).
5. Login and repeat [Step 1](#) of “[Preliminary Checks](#)” on page 4-1 to determine if the current version is the same as the upgrade version - this confirms the upgrade was successful.
6. If the upgrade was not successful, repeat [Step 1](#) through [Step 5](#). If still unsuccessful, contact Nautel.

---

## SECTION 5: LIST OF TERMS

This section defines some of the terms that are used in Nautel documentation.

**ADC.** Analog to Digital Converter.

**AES-EBU.** Audio Engineering Society/European Broadcasting Union (AES/EBU) is the name of a digital audio transfer standard. The AES/EBU digital interface is usually implemented using 3-pin XLR connectors (the same type connector used in professional microphones). One cable carries both left and right-channel audio data to the receiving device.

**B+.** The high voltage dc generated by the transmitter's ac power supply for use within the transmitter. The B+ voltage is used to supply the transmitter's modulators and other transmitter circuitry.

**CUTBACK.** A reduction in RF output power, caused by a total power limit fault or the occurrence of three shutbacks within a five second period.

**DAC.** Digital to Analog Converter.

**DAM.** Dynamic Amplitude Modulation.

**DCC.** Dynamic Carrier Control.

**DRM.** Digital Radio Mondiale. A set of digital audio broadcasting technologies designed to work existing AM radio channels.

**DSP.** Digital Signal Processing.

**FPGA.** Field Programmable Gate Array.

**HD RADIO.** HD Radio is another term for In Band On Channel (IBOC) technology. HD Radio is a trademark of iBiquity Digital Corporation.

**IBOC.** Nautel In-Band-On-Channel technology provides high quality digital audio over existing AM radio channels.

**IPM.** Incidental Phase Modulation

**LATCHING ALARM.** An alarm that, while active, keeps the transmitter in an 'RF inhibited' state. This type of alarm (e.g., High SWR Shutdown) require a reset - locally or remotely - to attempt to restore transmitter operation.

**NE IBOC.** Nautel's In-Band-On-Channel signal generator. See IBOC. Required for NX series IBOC installations.

**PDM.** Pulse Duration Modulation.

**PRESET.** A setting that controls power level, active exciter, and power scheduler status on a time-of-day and date basis. Exciters can be configured on a preset for a specific operating mode (for example, Exciter A - conventional AM, and Exciter B - IBOC). The NX50 allows you to pre-program multiple presets.

**SHUTBACK.** A complete loss of RF output power, caused by any one of a variety of faults, including high VSWR, low B+ voltage, high RF current, RF drive failure, external interlock or spark gap.

**SURGE PROTECTION BOARD.** An electrical panel that protects equipment from electrical surges in the ac power supply, antenna or site ground caused by lightning strikes.

**VSWR.** Voltage standing wave ratio. This is an expression of the ratio of forward voltage to reverse voltage on the feedline and antenna system. An ideal VSWR of 1:1 provides maximum transmitter-antenna efficiency.



## **NX50 OPERATIONS AND MAINTENANCE MANUAL**

Document: NHB-NX50-OPS

Issue: 3.0 2012-11-01

### **Nautel Limited**

10089 Peggy's Cove Road  
Hackett's Cove, NS Canada B3Z 3J4

Toll Free: +1.877.6NAUTEL (662.8835)  
(Canada & USA only) or

Phone: +1.902.823.3900 or

Fax: +1.902.823.3183

### **Nautel Inc.**

201 Target Industrial Circle  
Bangor, Maine USA 04401

Phone: +1.207.947.8200

Fax: +1.207.947.3693

### **Customer Service (24-hour support)**

+1.877.628.8353 (Canada & USA only)

+1.902.823.5100 (International)

Email: [support@nautel.com](mailto:support@nautel.com)

Web: [www.nautel.com](http://www.nautel.com)

© Copyright 2013 NAUTEL. All rights reserved.

