

NV30/NV40 TRANSMITTER

OPERATIONS AND MAINTENANCE MANUAL

Document: NHB-NV30-NV40-OPS-3.3

Issue: 3.3 2014-12-10

Status: Standard



Nautel Limited

10089 Peggy's Cove Road
Hackett's Cove, NS Canada B3Z 3J4
Phone: +1.902.823.3900 or
Toll Free: +1.877.6NAUTEL (6628835) (Canada & USA only)
Fax: +1.902.823.3183

Nautel Inc.

201 Target Industrial Circle
Bangor, Maine USA 04401
Phone: +1.207.947.8200
Fax: +1.207.947.3693

Customer Service (24 hour support)

+1.877.628.8353 (Canada & USA only)
+1.902.823.5100 (International)

Email: support@nautel.com

Web: www.nautel.com

The comparisons and other information provided in this document have been prepared in good faith based on publicly available information. The reader is encouraged to consult the respective manufacturer's most recent published data for verification.

© Copyright 2014 NAUTEL. All rights reserved.

CONTENTS

RELEASE CONTROL RECORD	VII
------------------------	-----

DESCRIPTION	1-1
-------------	-----

Ac-dc power stage	1-2
-------------------	-----

Control/monitor stage	1-3
-----------------------	-----

RF drive stage	1-4
----------------	-----

RF power stage	1-6
----------------	-----

OPERATING THE TRANSMITTER	2-1
---------------------------	-----

Using the AUI	2-2
---------------	-----

Home page	2-14
-----------	------

Menu page - describing transmitter operations	2-15
---	------

Logs page - viewing transmitter log	2-16
-------------------------------------	------

Viewing tool menu panels	2-25
--------------------------	------

Viewing real-time meters	2-40
--------------------------	------

Presets - editing operational settings	2-44
--	------

Viewing transmitter status	2-59
----------------------------	------

Factory Settings	2-61
------------------	------

System Settings	2-70
-----------------	------

User accounts	2-79
---------------	------

Changeover page	2-83
-----------------	------

User settings	2-84
---------------	------

Remote I/O page	2-104
-----------------	-------

ROUTINE MAINTENANCE	3-1
---------------------	-----

Scheduled maintenance	3-1
-----------------------	-----

Replacing an air filter	3-3
-------------------------	-----

Performing on-air checks	3-5
--------------------------	-----

Replacing the control/interface PWB battery	3-6
Replacing the NVE exciter PWB battery	3-7
Inspecting lightning protection systems	3-8

NON-STANDARD MAINTENANCE	4-1
Upgrading software	4-1
Improving transmitter performance for IBOC presets	4-4
Changing the RF output connector	4-6
Bypassing the UPS interface option	4-11

LIST OF TERMS	5-1
----------------------	------------

RELEASE CONTROL RECORD

Issue	Date	Reason
3.0	2011-11-10	Release 3 of product (NARF50B)
3.1	2012-12-15	Section 2: updated to support software release 4.0 Section 3: expanded air filter descriptions to include M7, MERV 7 filters as suitable replacements
3.2	2013-10-01	Added Nautel Phone Home to User Settings
3.3	2014-12-10	Section 2: updated to support software release 4.2.7 or later; changed exciter TCXO screen to show dual exciter option

SECTION 1: DESCRIPTION

Refer to the functional block diagram: [NV Series Transmitter Block Diagram](#) - see page 1-9.

This section provides a high-level description of the transmitter's key sections. The transmitter circuitry is subdivided into four basic stages:

- [Ac-dc power stage](#)
- [Control/monitor stage](#) - see page 1-3
- [RF drive stage](#) - see page 1-4
- [RF power stage](#) - see page 1-6

NV30/NV40 ELECTRICAL SCHEMATICS

Some descriptions in this section refer to electrical schematics (SD-#s) . These are located in Section 5 of the *NV30/NV40 Troubleshooting Manual*.

REDUNDANCY

The NV30/NV40 features redundancy in all key systems:

- RF power modules
- Exciters
- Cooling fans
- Cooling fan power supplies
- Low voltage power supplies
- SBC/AUI power supplies

AC-DC POWER STAGE

See electrical schematics **SD-1 (A, B or C)**, **SD-2** and **SD-3**.

The ac-dc power stage converts the ac power source to a positive dc voltage (PA volts) for the transmitter's intermediate (IPA) and RF power amplifiers. The transmitter accepts a wide range of ac input voltage options:

- 3-phase, 180 - 264 V ac (208 V ac nominal)
- 3-phase, 312 - 457 V ac (380 V ac nominal)
- 1-phase, 180 - 264 V ac (240 V ac nominal)

The ac-dc power stage provides power to operate cooling fans in the power supply modules, RF power modules and reject load modules. It also provides power to the low voltage power supplies, which generate the low level dc voltages (± 15 V and +5 V) used throughout the transmitter, and to the +12 V dc power supplies for the SBC (single-board computer) and AUI (advanced user interface).

The ac-dc power stage comprises ac input terminal blocks TB1, TB2 and TB3, an ac distribution assembly (A6), a power supply distribution PWB (A7), SBC/AUI power supplies A (U1) and B (U2), LVPS modules A (U3) and B (U4), fan power supply modules A (U7) and B (U8), IPA power supply modules A (U9), B (U10) and C (U11), and dual PA power supply modules (U12 through U43) for each of the 16 RF power modules. There is also a PS interface PWB associated with each power supply module (fan, IPA and PA).

POWER SUPPLY MODULES

See Figure **SD-2**. Power supply modules U9 through U43 convert the ac input voltage to a regulated dc supply (IPA volts and PA volts) for 16 RF power modules (module contains both IPA and PA). Each switching power supply module provides 2000 W output, at typical levels of 50 V and 40 A. The modules regulate the output voltage based on a *PA (or IPA) Volts Control* input from the control/monitor stage. Test points on the associated PS interface PWB allow monitoring of module presence and ac input status. Each module has a built-in cooling fan and each senses out-of-regulation and excessive temperature conditions and applies PS Fail and PS Temp alarm signals to the associated RF power module. Both conditions cause the power supply to shut itself down, thus reducing the transmitter's RF output.

The same modules are used for fan power supply modules U7 and U8. Their *PS Fail* and *PS Temp* alarm signals, as well as the *PS Module Present* status signal, are applied to the control/monitor stage.

LVPS MODULES

See Figure SD-1 (A, B or C). LVPS modules A (U3) and B (U4) convert the ac input voltage to the regulated low voltage dc supplies. The +5 V, +15 V and -15 V regulated outputs of the supplies are ORed together at the control/interface PWB (A1) and applied throughout the transmitter.

+12 V POWER SUPPLY MODULES

See Figure SD-1 (A, B or C). +12 V power supply modules A (U1) and B (U2) convert the ac input voltage to the regulated +12 V dc supplies. The +12 V outputs are ORed together on the power supply distribution PWB (A7) and a common +12 V supply is applied to the control/monitor stage.

POWER SUPPLY DISTRIBUTION PWB

See Figures SD-1 (A, B or C) and SD-3. The power supply distribution PWB (A7) interfaces between fan power supply modules U7 and U8 and the cooling fans for RF power modules 1 through 16 and reject loads A, B and C. The fan voltage (+48 V) is applied via power rectifiers CR1 and CR2 to the transmitter's cooling fans. A nominal 47 V is applied as *Fan V Sample A* and *B* to the control/monitor stage for metering and fan PS fault detection.

The power supply distribution PWB also interfaces between SBC/AUI power supplies U1 and U2 and the control/monitor stage. +12 V is applied via power rectifiers CR3 and CR4 to the control/monitor stage. A nominal +12 V is applied as *+12V Sample A* and *B* to the control/monitor stage for metering and supply fault detection.

CONTROL/MONITOR STAGE

See electrical schematics SD-4 and SD-5 and [Figure 1.1 on page 1-4](#). The control/monitor stage monitors critical samples and status/alarm signals from the ac-dc power stage, RF drive stage and RF power stage. For example, RF power monitoring and RF power stage status information is applied to the control/monitor stage. Based on the value and status of each input, the control/monitor stage produces the appropriate control signals for the RF power stage to ensure the proper operation and protection of the transmitter. The control/monitor stage also provides the remote control/monitor interface for the transmitter.

The control/monitor stage comprises a control/interface PWB (A1), a remote interface PWB (A2), an LCD touch monitor (U5) and a single-board computer (U6).

U5 is a 17-inch, colour LCD screen that is mounted on the front of the transmitter. It provides an advanced user interface (AUI) for the transmitter. The AUI can be controlled by touch screen and is also available as a flash graphic on any web-interfaced PC or handheld device via the internal NV web server. See [“Using the AUI” on page 2-2](#) for detailed information on AUI functionality.

The control/interface PWB contains push-button switches that provide backup control for the RF on/off, local/remote, power increase/decrease and reset functions. It also contains LEDs that serve as an alternate means to monitor status (local/remote and RF on/off), forward power level (percentage indicators from 10% to 100% of maximum RF output power) and various alarms.

Figure 1.1: Control/Monitor Stage

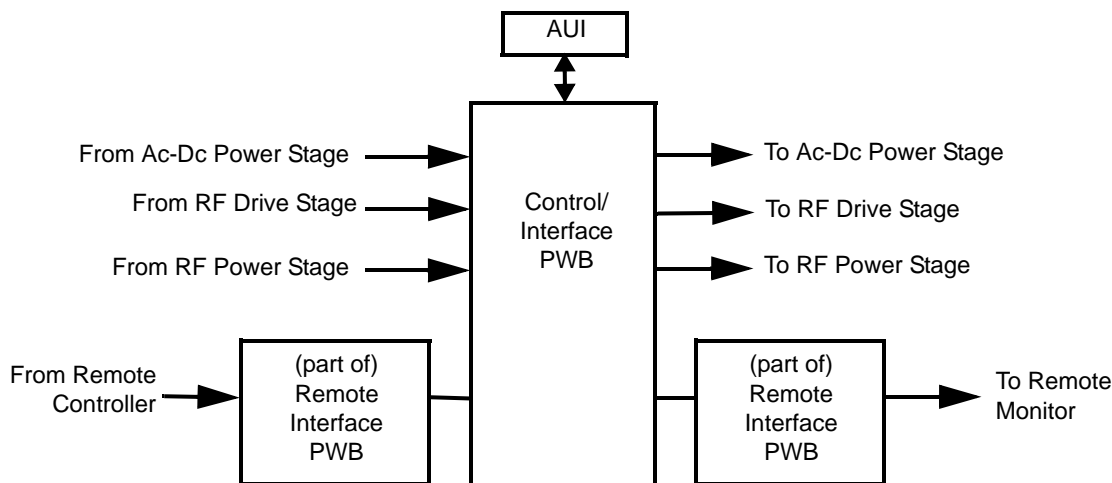

RF DRIVE STAGE

See Figure SD-6. The RF drive stage converts the exciter's RF output to the intermediate RF level needed to drive the RF power modules. It consists of exciter A (A3), exciter B (A4, optional) and RF drive splitter/changeover assembly (A5).

EXCITER(S)

Refer to the functional block diagram: [NVE300 Exciter Block Diagram](#) - see page 1-10.

Exciters A (A3) and B (A4) are the RF drive sources for the transmitter. They accept the external audio program and/or IBOC information (see the *NV30/NV40 Installation Manual* for details on various program input types). The exciters' main/standby operation is controlled locally using the AUI, or remotely. The exciter outputs are applied to the RF drive splitter/changeover assembly (A5). The exciter provides an RF drive signal of 130 W (in analog mode).

RF DRIVE SPLITTER/CHANGEOVER ASSEMBLY

The RF drive splitter/changeover assembly (A5) controls the routing of the main and standby exciters and provides the RF drive signals for the 16 RF power modules. The assembly is comprised of the splitter/changeover PWB (A5A1), two 4-way RF drive splitter PWBs (A2 and A3), two attenuator PWBs (A4 and A5) and eight 3 dB hybrid couplers (U1 through U8).

EXCITER RELAY CONTROL

The RF drive outputs from exciters A and B are applied to the splitter/changeover PWB (A5A1) at A5A1J1 and A5A1J2 respectively. The *Exciter Relay Control* input (A5A1J3-4) is a signal applied from the control/monitor stage that controls relay A5A1K1.

- When exciter A is selected as the main RF drive source, the *Exciter Relay Control* input is open circuit and relay A5A1K1 will be de-energized. Exciter A's output will be applied to 3 dB hybrid coupler A5A1U1.
- When exciter B is selected as the main RF drive source, the *Exciter Relay Control* input is near ground potential (0 V) and relay A5A1K1 will be energized. Exciter B's output will be applied to 3 dB hybrid coupler A5A1U1.

EXCITER DRIVE SPLITTER

The splitter/changeover PWB's 3 dB hybrid coupler (A5A1U1) is connected as a splitter. The RF drive source (A or B) selected by relay A5A1K1 is applied to A5A1U1's input. The signal is split into two equal amplitude signals that are 90° out-of-phase. These split signals are applied to 4-way RF drive splitter PWBs A5A2 and A5A3.

4-WAY RF DRIVE SPLITTER

Each 4-way RF drive splitter PWB (A5A2 and A5A3) accepts an output from the exciter 3 dB hybrid coupler and splits it into four equal amplitude signals, using three 3 dB couplers identical to A5A1U1. The outputs of each 4-way RF drive splitter are applied to the final RF drive splitters.

FINAL RF DRIVE SPLITTERS

3 dB hybrid couplers A5U1 through A5U8 (identical to A5A1U1) are connected as splitters. Each coupler accepts an output of the 4-way RF drive splitters and splits the signal into two equal amplitude signals that are 90° out-of-phase. These split signals are applied to attenuator PWB A5A4 and A5A5.

ATTENUATORS

The attenuator PWBs (A5A4 and A5A5) accept the outputs from the 4-way RF drive splitter PWBs and attenuate each of the signals for application to the 16 RF power modules. Attenuation values are set in order to balance the RF drive output levels.

RF POWER STAGE

See Figures SD-7, SD-8 and SD-9. The RF power stage accepts the intermediate RF drive inputs from the RF drive stage and generates the final RF output. It consists of 16 RF power modules, four module backplane PWBs (A17, A32, A50 and A65), four 10 kW combiner/filters (A16, A31, A49 and A64), two 20 kW combiners (A30 and A63), a 40 kW combiner (A48), an output power probe (A13), three reject load assemblies [A (A14, 8-input), B (A45, 4-input) and C (A46, 4-input)] and two reject load interface PWBs [A (A15) and B (A47)].

RF POWER MODULE

See Figure SD-7 (see the *NV30/NV40 Troubleshooting Manual* for a detailed RF power module description) and “[RF Power Module Block Diagram](#)” on page 1-11.

Each of the 16 RF power modules provides up to 2750 W (for NV40) or 2062.5 W (for NV30) of RF output power and is comprised of an IPA power amplifier PWB, eight power amplifier PWBs, power module interface PWB, combiner PWB, splitter PWB and six cooling fans. The intermediate RF drive outputs from the RF drive stage are applied to the RF power modules via module backplane PWBs 1-4 (A17), 5-8 (A32), 9-12 (A50) and 13-16 (A65). Within each RF power module, the intermediate RF drive signal is sampled and then drives the IPA amplifier. The IPA output is sampled then split to drive the module's eight PAs. The *IPA Volts* and *PA Volts* inputs from the associated switching power supply modules control the RF output of the IPA and eight PAs, respectively. The RF power module receives alarm and status signals (*PS Temp*, *PS Fail*, *PS AC Fail*, and *PS Module Present*) from the ac-dc power stage. The RF power module also provides a *Pwr Supply Inhibit* signal (one for each of the power module's dual supplies) to the ac-dc power stage, which, when active, inhibits the associated switching power supply. A *PA V Sample* and *IPA V sample* from each RF power module is applied to the control/monitor stage. The control/monitor stage supplies a *PA Volts Inhibit* signal, which controls the PA outputs of the RF power module.

MODULE BACKPLANE PWB

See Figure SD-7. Each set of four RF power modules (1-4, 5-8, 9-12 and 13-16) has an associated module backplane PWB which interfaces with all module inputs and outputs, except for the RF output. It also provides the fan volts connections for the module's cooling fans. The setting of dipswitches S1 through S4 assign a four-bit address for each specific module based on module position. Jumper E1 is set to **TERM** on RF power module 16 (the last module) to terminate the RS-485 serial communication cable.

COMBINER/FILTERS

See Figure SD-8. There are various stages of combiners used in the transmitter. All combining follows a corporate (or binary) structure in that pairs of RF power blocks are combined throughout the RF chain from the RF power modules to the RF output.

10 kW COMBINER/FILTERS

Each 10 kW combiner/filter (A16, A31, A49 and A64) is a 2-stage combiner that accepts the RF outputs from four RF power modules and provides a single RF output. Each 10 kW combiner/filter uses three 3 dB hybrid couplers - two of which are used in the initial pair of 5 kW combiners, which each accept the outputs of two RF power modules. The equal amplitude, 90° out-of-phase (quadrature) RF signals are combined at the 3 dB hybrid coupler outputs and applied to a third and final, 10 kW 3 dB hybrid coupler. Again, the equal amplitude, quadrature RF signals are combined. The combined output is applied to a 10 kW low pass filter before being applied to a 20 kW combiner.

Any amplitude or phase imbalances between 3 dB hybrid coupler inputs cause a proportional signal to be applied to the applicable reject load assemblies. The amplitude of the *5 kW Rej Ld Pwr* signals (via J5 and J6) represents imbalance between the combined outputs of the first stage of combining. The amplitude of the *10 kW Rej Ld Pwr* signal (via J7) represents imbalance between the combined outputs of the second stage of combining (differences in pairs of RF power modules).

20 kW COMBINERS

The 20 kW combiners (A30 and A63), which are hybrid couplers, accept the RF outputs from the 10 kW combiner/filters. The equal amplitude, 90° out-of-phase (quadrature) RF signals are combined at hybrid coupler outputs and applied to the 40 kW combiner.

Any amplitude and phase imbalances between the inputs of the 20 kW combiners causes a proportional signal to be applied (via J1) to the applicable reject load assemblies. The amplitude of the *20 kW Rej Ld Pwr* signals represents imbalance between the combiner inputs.

40 kW COMBINER

The 40 kW combiner (A48), which is a hybrid coupler, accepts the RF outputs from the 20 kW combiners. The equal amplitude, 90° out-of-phase (quadrature) RF signals are combined at the hybrid coupler output and applied to the output power probe.

Any amplitude and phase imbalances between the inputs of the 40 kW combiner causes a proportional signal to be applied (via J1) to the applicable reject load assembly. The amplitude of the *40 kW Rej Ld Pwr* signal represents imbalance between the combiner inputs.

OUTPUT POWER PROBE

See Figure SD-8. The output power probe (A13) monitors the transmitter's forward and reflected power and generates the *Fwd Pwr Sample* (A1J1) and *Refld Pwr Sample* (A2J1) signals applied to the control/monitor stage for protection and monitoring; RF monitor PWB A3 provides a nominal 4.5 V (NV40) or 3.7 V (NV30) rms [at 40 kW (NV40) or 30 kW (NV30) signal at A3J1 for use with a

modulation monitor or spectrum analyzer. RF sample PWBs A4 and A5 provide similar samples at A4J1 and A5J1. These samples are applied to exciters A and B (if used) for use by the exciters' adaptive pre-correction circuitry [for all-digital (HD) or hybrid (FM+HD) modes of operation] and also by the AUI's spectrum analyzer display.

REJECT LOAD ASSEMBLIES

See Figure **SD-9**. Reject load assemblies provide a means to dissipate reject power from the outputs of the combiner/filter's 3 dB hybrid couplers. Reject load assemblies contain power resistors to dissipate reject power and cooling fans to regulate temperature. There are three different reject load assemblies (A, B and C) used in the transmitter.

8-INPUT REJECT LOAD ASSEMBLY 'A'

Reject power generated by the 5 kW combining stage of any of the four 10 kW combiner/filter assemblies is dissipated by resistors in 8-input reject load assembly 'A' (A14). Micro-strip transmission lines (on 8-input reject load PWB A14A1) in close proximity to the reject load signals induce eight true RF sample voltages of the associated reject power. These samples are peak detected and applied to the control/monitor stage via reject load interface PWB 'A' (A15). The reject load interface PWB provides an interface between the ac-dc power stage's *Fan Volts* supply and the reject load assembly's cooling fans. It also acts as the interface between the cooling fans' *Rej Fan Tach* signals and the control/monitor stage.

4-INPUT REJECT LOAD ASSEMBLY 'B'

Reject power generated by the output combining stage of any of the four 10 kW combiner/filter assemblies is dissipated by resistors in 4-input reject load assembly 'B' (A45). Micro-strip transmission lines (on 4-input reject load PWB A45A1) in close proximity to the reject load signals induce four true RF sample voltages of the associated reject power. These samples are peak detected and applied to the control/monitor stage via reject load interface PWB 'B' (A47). The reject load interface PWB provides an interface between the ac-dc power stage's *Fan Volts* supply and the reject load assembly's cooling fans. It also acts as the interface between the cooling fans' *Rej Fan Tach* signals and the control/monitor stage.

4-INPUT REJECT LOAD ASSEMBLY 'C'

Reject power generated by the output combining stage of either of the two 20 kW combiners or the 40 kW combiner is dissipated by resistors in 4-input reject load assembly 'C' (A46). Micro-strip transmission lines (on 4-input reject load PWB A46A1) in close proximity to the reject load signals induce three true RF sample voltages of the associated reject power. These samples are peak detected and applied to the control/monitor stage via reject load interface PWB 'B' (A47). The reject load interface PWB provides an interface between the ac-dc power stage's *Fan Volts* supply and the reject load assembly's cooling fans. It also acts as the interface between the cooling fans' *Rej Fan Tach* signals and the control/monitor stage.

Figure 1.2: NV Series Transmitter Block Diagram

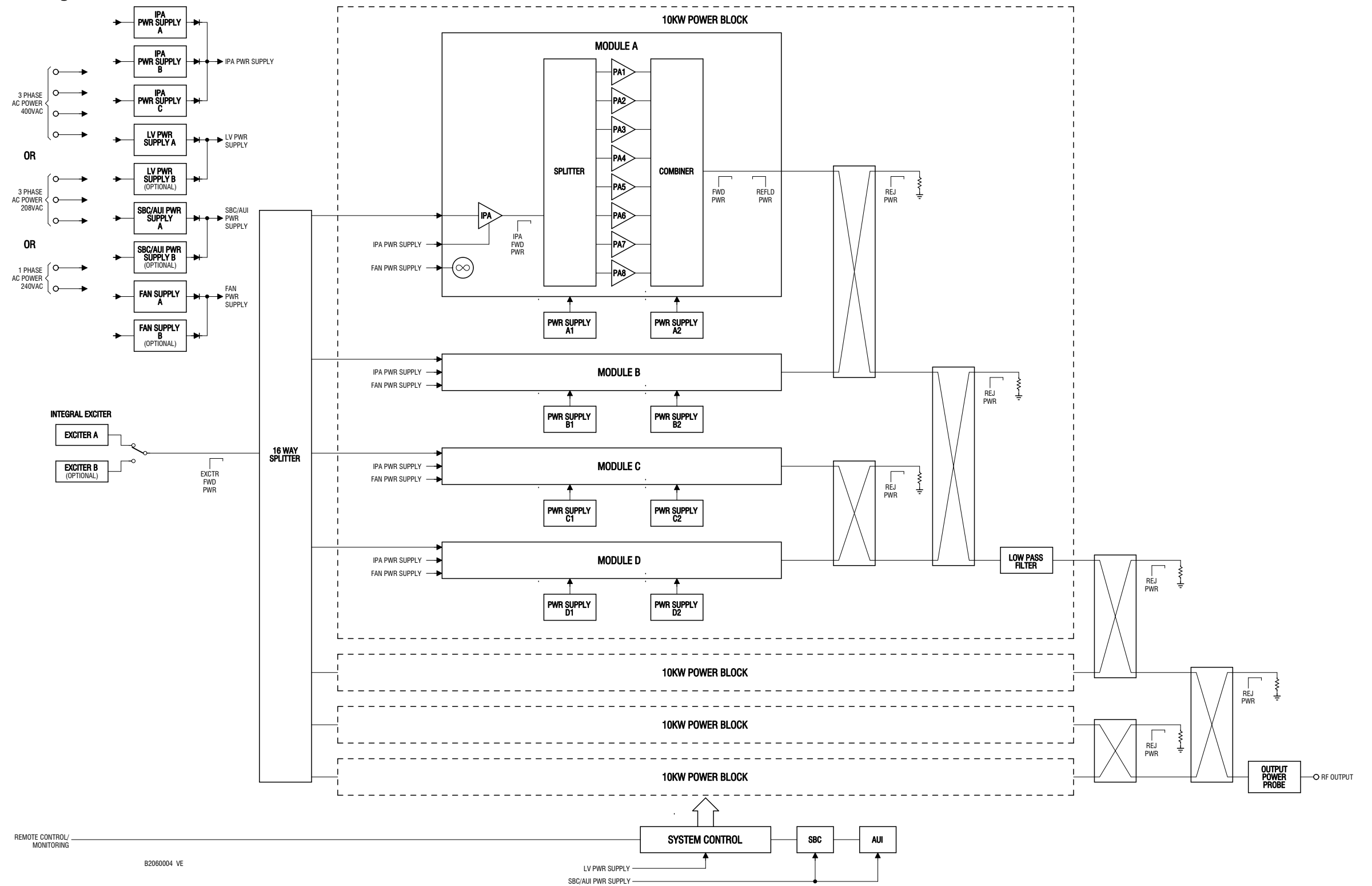

Figure 1.3: NVE300 Exciter Block Diagram

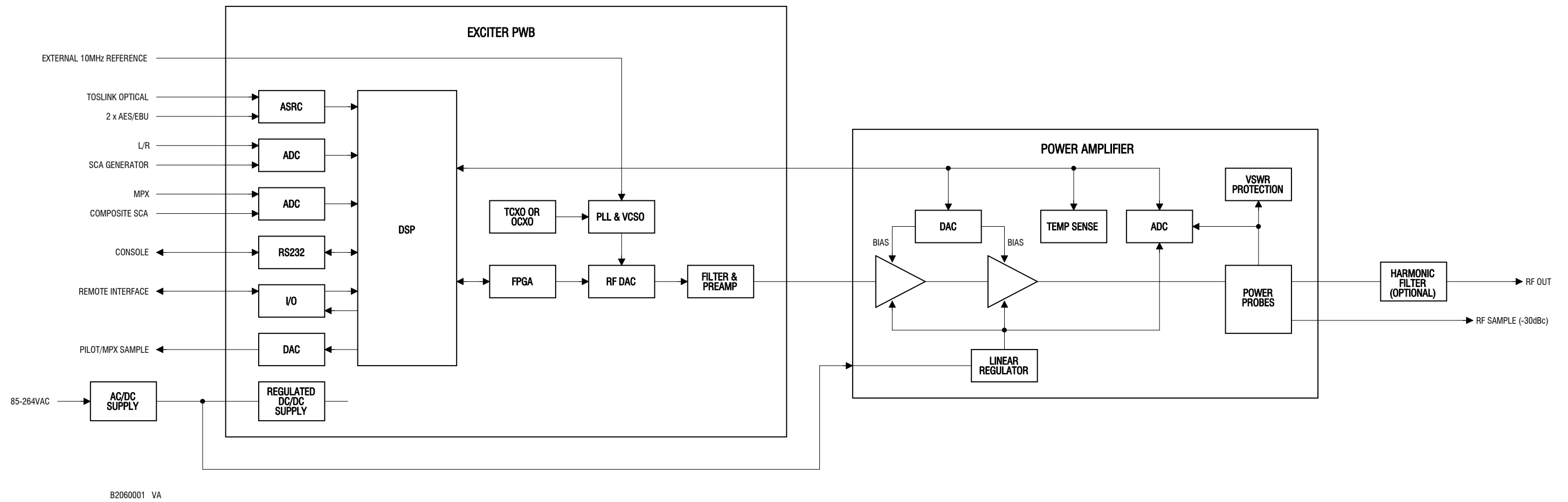
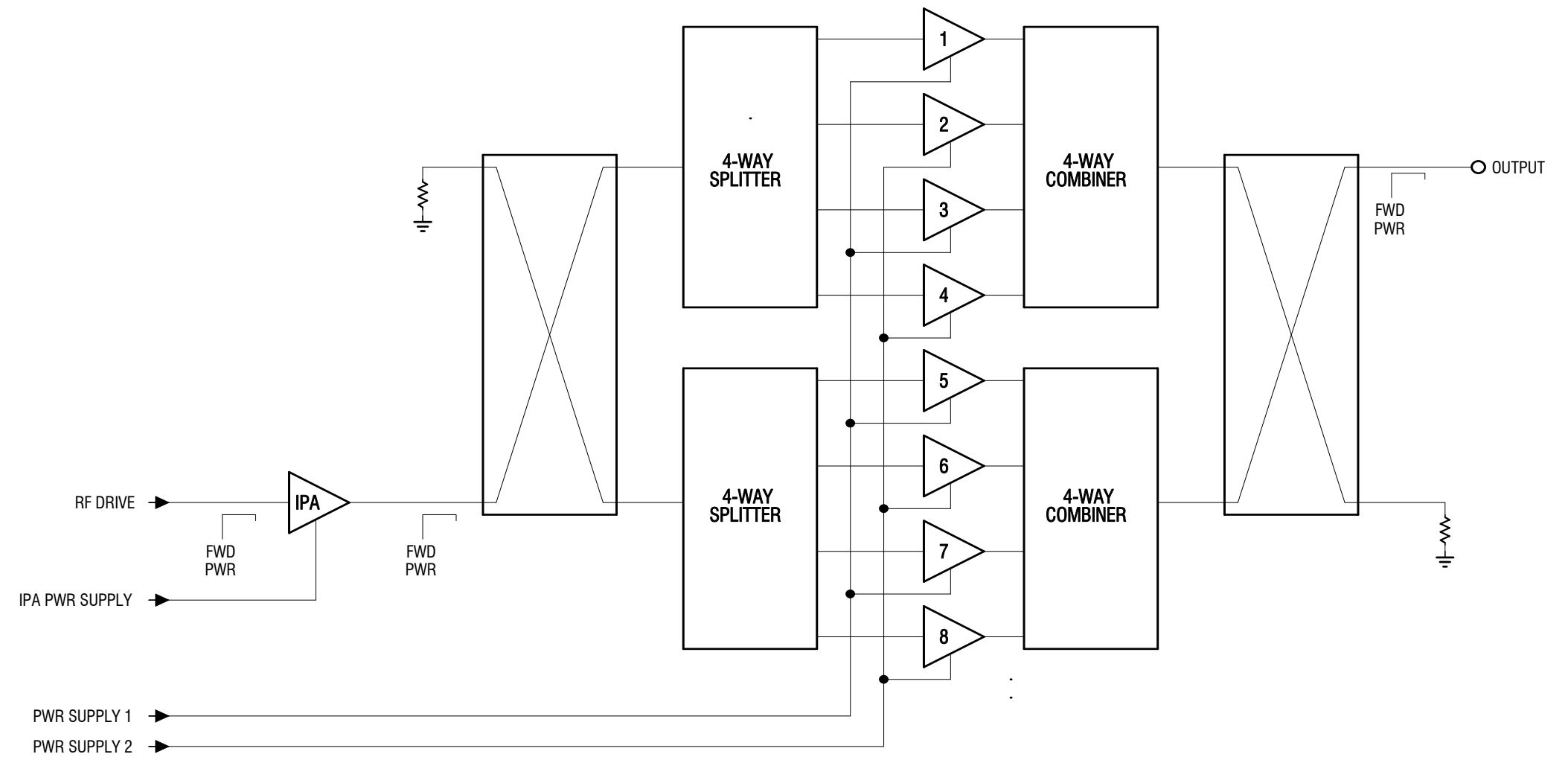

Figure 1.4: RF Power Module Block Diagram



B2060005 VB

SECTION 2: OPERATING THE TRANSMITTER

This section provides information about operating the NV30/NV40 transmitter:

- [Using the AUI - see page 2-2](#)
- [Home page - see page 2-14](#)
- [Menu page - describing transmitter operations - see page 2-15](#)
- [Logs page - viewing transmitter log - see page 2-16](#)
- [Viewing tool menu panels - see page 2-25](#)
- [Viewing real-time meters - see page 2-40](#)
- [Presets - editing operational settings - see page 2-44](#)
- [Viewing transmitter status - see page 2-59](#)
- [Factory Settings - see page 2-61](#)
- [System Settings - see page 2-70](#)
- [User accounts - see page 2-79](#)
- [Changeover page - see page 2-83](#)
- [User settings - see page 2-84](#)
- [Remote I/O page - see page 2-104](#)

USING THE AUI

The NV30/NV40 has an advanced user interface (AUI) that is displayed on a 17-inch, colour LCD screen mounted on the front of the control cabinet ([Figure 2.1](#)). The AUI is controlled via touch screen that you can also access using a PC and a web browser.

This section includes the following topics:

- [Logging into the AUI on page 2-3](#)
- [Describing the AUI layout on page 2-9](#)
- [List of AUI pages on page 2-10](#)
- [Navigating from page to page on page 2-13](#)

Figure 2.1: NV30/NV40 AUI

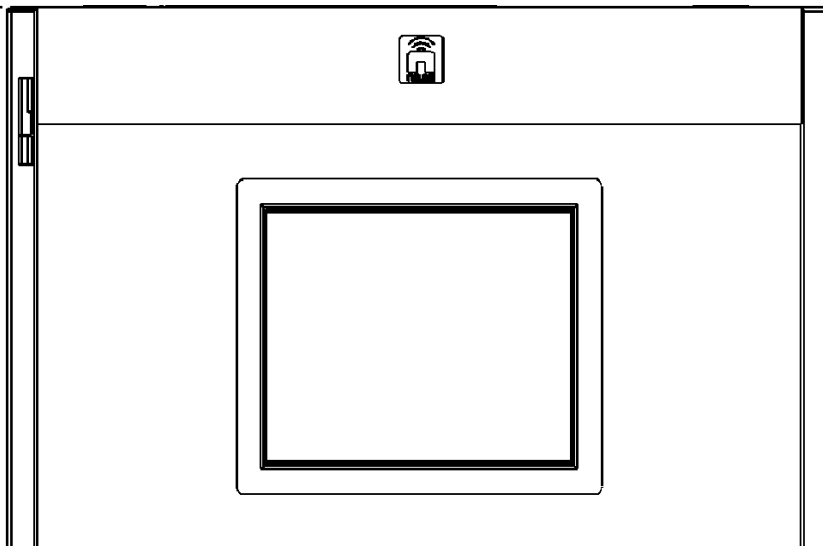

Information is displayed in a series of pages (screens) that serve specific transmitter functions. The AUI has the following configurable displays:

- Login Page (see [Logging into the AUI on page 2-3](#))
- Events logs (see [Logs page - viewing transmitter log on page 2-16](#))
- Instrumentation panels ([Viewing instrument panels on page 2-27](#))
- Real-time meters (see [Meters Page on page 2-40](#))
- Presets (see [Presets - editing operational settings on page 2-44](#))
- Transmitter status (see [Viewing transmitter status on page 2-59](#))
- Factory settings (see [Factory Settings on page 2-61](#))
- System settings (see [System Settings on page 2-70](#))
- User accounts (see [User accounts on page 2-79](#))
- Changeover (see [Changeover page on page 2-83](#))
- User settings (see [User settings on page 2-84](#))
- Remote input/output configuration (see [Remote I/O page on page 2-104](#))

See the complete AUI flow diagram illustrated in Figure 2.2 on page 2-5.

LOGGING INTO THE AUI

The transmitter's AUI provides a means to restrict local and remote access to transmitter control functions to authorized users only. Users can create accounts that can be pre-defined to set access restriction from view-only (no control), full control (all permissions), custom (select permissions) and administrative control.

REMOTE ACCESS

To access the transmitter's AUI remotely, perform the following steps:

1. Configure your network settings (see [Setting up the network on page 2-85](#)).

2. On your router or firewall software, open ports **3501** (3501 is factory default, use corresponding other port if changed) and **80** and close (restrict access to) all other ports. If you are using RDS data, open port **7005**. If you are using SNMP, open ports **161** (Agent) or **162** (Traps).
3. When properly configured as noted above, the login menu (see [Figure 2.3 on page 2-9](#)) will appear in your web browser when IP address is accessed. Your IP address and any login messages appear in a box at the top, beside the logo, and the current AUI software version number appears along the bottom of the login window.
4. Log in to the AUI by entering the appropriate parameters in the login window.
 - In the **Language** field, press the down-arrow to review a drop-down menu displaying the available language options, and select one.
 - In the **User** field, enter the username. Default is “Nautel”.
 - In the **Password** field, enter the password. Default is blank.

**Note:**

The Nautel AUI is factory configured with a default login username and password. Nautel recommends that you change the password to improve overall system security. See [Changing the password on page 2-81](#).

- Press **Submit** to accept your login parameters and display the AUI home page ([Figure 2.6 on page 2-14](#)). Note: The opening screen (the **Home** page) will have the layout from the previous login session.

**Note:**

If you do not have a user account, it must be set up by an existing user with proper permissions. See [Adding an account on page 2-80](#).

**Note:**

If no login attempt is made after 60 seconds, a timeout feature will be activated and the web browser will need to be refreshed in order to attempt another login.

LOCAL ACCESS

When properly configured, (but without auto login selected) the login menu will appear on the transmitter 17-inch LCD touchscreen. Log into the AUI by entering the appropriate parameters in the login window.

- In the **Language** field, press the down-arrow to review a drop-down menu displaying the available language options, and select one.
- In the **User** field, enter the username. Default is “Nautel”.
- In the **Password** field, enter the password. Default is blank.
- Press **Submit** to accept your login parameters and display the AUI home page ([Figure 2.6 on page 2-14](#)). Note: The opening screen (the **Home** page) will have the layout from the previous login session.
- If auto login is set the AUI will appear automatically without the required previous steps (see [Setting auto login \(local only\) status on page 2-81](#)).

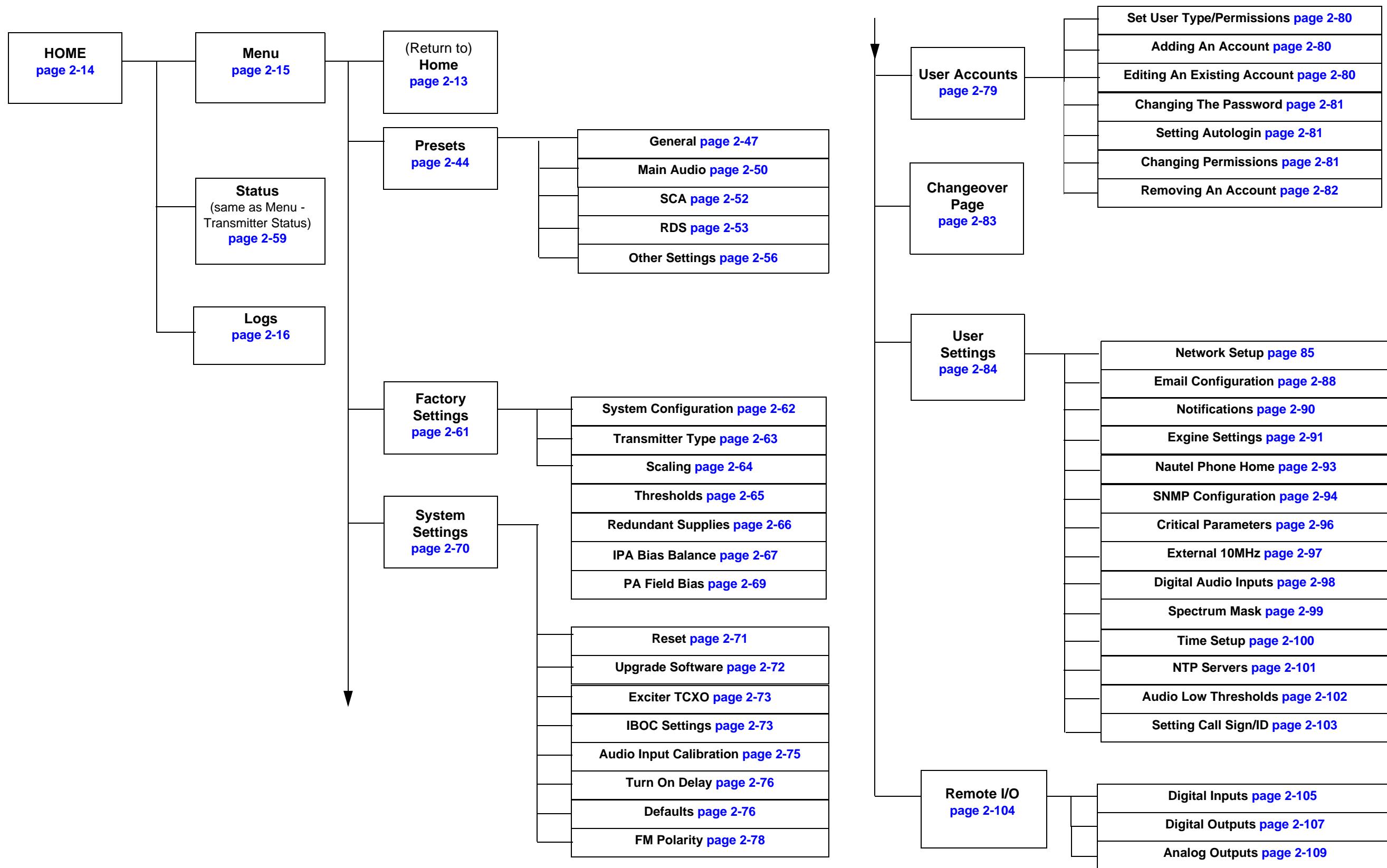

Figure 2-2: NV Transmitter AUI Flow Diagram

Figure 2.3: Remote AUI Login Menu

DESCRIBING THE AUI LAYOUT

The AUI begins with the **Home** page and all further navigation will start from this screen (see [Figure 2.4 on page 2-11](#)).

Any user can view the AUI pages on the front panel of the transmitter, regardless of the login status; however, only users with the appropriate permission level can access functions that alter the transmitter control settings.

Users can access the login menu by pressing the **Change User** button located in the bottom banner of the AUI when logged in locally. It should be noted that this same button is shown as **Log Out** if viewing the AUI remotely (see [Figure 2.4 on page 2-11](#)).

LIST OF AUI PAGES

Table 2.1 defines the available AUI pages.

Table 2.1: AUI Pages

AUI Page	Function	See Page
Home	View meters, tool menu panels, choose options and navigate to other pages.	page 2-14
Menu	Choose options and navigate to other pages.	page 2-15
Transmitter Log	View transmitter event history.	page 2-16
Tool Menu	Choose tool menu panel options.	page 2-25
Meters List View	Choose meters for display.	page 2-40
Presets	Edit user-defined presets.	page 2-44
Transmitter Status	View transmitter's current active faults and operational status.	page 2-59
Factory Settings	View critical transmitter parameters.	page 2-61
System Settings	Users determine critical system configuration parameters.	page 2-70
User Accounts	Set user permission rights and define user account information.	page 2-79
Changeover	Set main exciter and auto exciter changeover function.	page 2-83
User Settings	Set network information, configure email and alarm notification parameters, configure Exgine interface information, configure SNMP information, capture critical parameters, set time and date, enable/configure NTP servers and set call sign/ID.	page 2-84
Remote I/O	Define remote digital inputs/outputs and configure analog outputs.	page 2-104

Each AUI page provides information about a specific transmitter function. All navigation through the AUI pages begins on the main screen shown in [Figure 2.4 on page 2-11](#).

Figure 2.4: Using the AUI

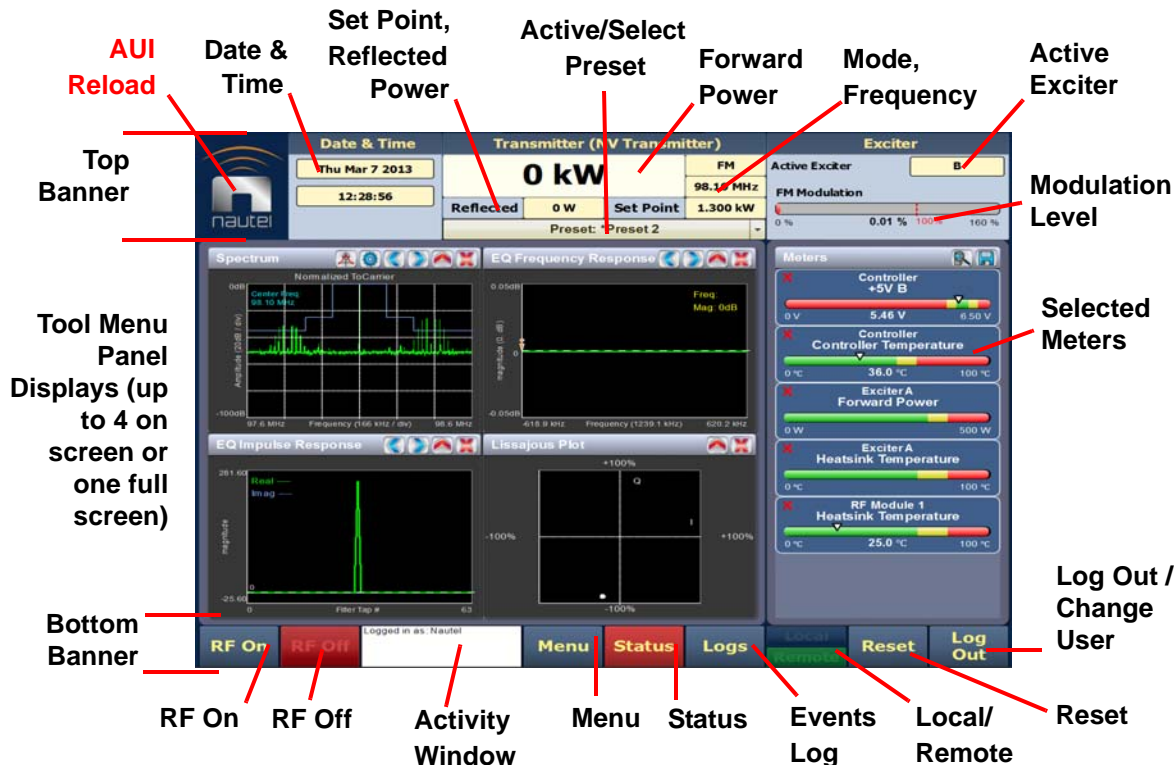

The top banner is permanent on all AUI pages and includes:

- **Nautel Logo:** From any AUI page, press the displayed logo to reload the AUI and prompt for a login. Press this if your local AUI stops responding.
- **Date & Time:** Displays the date (including day of the week, month, day and year) and current time (see [Time setup on page 2-100](#)).
- **Transmitter:** Displays the name of the active preset, current forward power (and power set point based on the active preset) and reflected power levels as well as the operating mode (FM, FM+HD, HD, etc.) and carrier frequency. (see [Presets - editing operational settings on page 2-44](#)). Press **Menu/Presets** (bottom panel) to open the Presets page and edit this information. Also the call Sign/ID is displayed here (see [Setting call sign/ID on page 2-103](#)).
- **Preset:** Displays the active preset. Press this area to open the **Activate Preset** menu and select the active preset.
- **Exciter:** Displays the active exciter and the peak (red) FM modulation value. Press in the Active Exciter field to shortcut to the **Changeover** page. [The active exciter is displayed in the top, right corner \(see Figure 2.4\)](#).

- **Forward Power:** Displays the analog power output when in FM or FM +HD modes and displays the HD power output when in HD (only) mode.

The bottom banner is also permanent on all AUI pages and includes the following buttons, some of which open other menus and displays:

- **RF On:** Press to enable the transmitter's RF power stage. When the button is highlighted green, RF is enabled (on). When the button is highlighted amber, a fault condition exists that is preventing the RF power stage from turning on.
 - **RF Off:** Press to disable the transmitter's RF power stage. When button is highlighted in red, RF is disabled (off).
 - **Activity Window:** Displays various messages to reflect specific user interface commands, such as RF on/off, local/remote control, or reset.
 - **Menu:** Press to open the **Menu** page, which allows navigation to various other pages (see [Menu page - describing transmitter operations on page 2-15](#)).
 - **Status:** Press to open the **Transmitter Status** page (see [Viewing transmitter status on page 2-59](#)), which provides current alarm and status details for the transmitter. When the **Status** button is red, one or more alarms of "high" severity is currently being reported and the transmitter is in an 'off-air' state. When the **Status** button is amber, "medium" or yellow "low" one or more lower level alarms is currently being reported, but the transmitter is still 'on-air', possibly at reduced power. When the **Status** button is green, the transmitter is operating normally. In this case there are no alarms being reported.
 - **Logs:** Press to shortcut to the **Transmitter Log** page, which displays historical alarm and status records for the transmitter (see [Logs page - viewing transmitter log on page 2-16](#)).
 - **Local/Remote:** Displays the operational control status of the transmitter. From the touch screen, press the desired button. If **Local** is highlighted green, only local control of the AUI is possible. If **Remote** is highlighted green, only remote control is possible (however local users can still navigate through the menus and disable the RF output by pressing RF Off).
 - **Reset:** Press to reset protection circuits and restore any RF power modules (and associated power supplies) that were inhibited, but are now alarm-free.
 - **Change User/Log Out:** Press to display a login menu. Enter your username and password, then press **Done**. If you do not have a user account, see [Factory Settings on page 2-61](#). **Change User** button will display as **Log Out** while viewing AUI remotely.
-

The displays between the top and bottom menus, contains user selected pages. These pages provide access to a variety of AUI functions such as transmitter status and hardware settings. The following paragraphs describe how to use these pages.

- **Tool Menu:** Display up to four panels on the screen at one time. To reveal the **Tool Menu** options, press **X** in the upper right corner of one panel to close an existing panel, and then press in the blank space to display a menu of panels (see [Viewing tool menu panels on page 2-25](#)).
- **Meters:** Displays the real-time meters that provide a system review of the transmitter (see [Viewing real-time meters on page 2-40](#)).

NAVIGATING FROM PAGE TO PAGE

You can easily navigate through the AUI from its **Home** page (see [Figure 2.6 on page 2-14](#)) or **Menu** page (see [Figure 2.7 on page 2-15](#)). During navigation, all **Menu** pages will feature a red exit page button (see [Figure 2.5](#)). Press this button to exit the **Menu** page you are on and return to the **Home** page.

Figure 2.5: Exit Page Button



Press this button to exit all menu pages.

HOME PAGE

The **Home** page is the first screen to appear when you login into the AUI. You can return to the Home page, from any screen, by pressing on the logo (upper left corner) or by pressing **Menu > Home**.

Figure 2.6: Home Page



Press the **Menu** button to view the various sub-menu options (see [Figure 2.7 on page 2-15](#)).

MENU PAGE - DESCRIBING TRANSMITTER OPERATIONS

From the Home page, press the **Menu** button to view the **Menu** page (see [Figure 2.7](#)). The **Menu** page displays icons that link to pages that control various transmitter operations.

Figure 2.7: Menu Page



Select **Home** to return to the home page (see [Figure 2.6 on page 2-14](#)).

Choose **Presets** to open screens related to presets (see [Editing or creating presets on page 2-45](#)).

Select **Factory Settings** to view various parameters relating to the transmitter (see [Factory Settings on page 2-61](#)).

Press **System Settings** to access pages that allow users to reboot the AUI or active exciter, perform software upgrades, configure **IBOC Settings**, set **Audio Input Calibration**, configure **FM Polarity** etc. (see [System Settings on page 2-70](#)).

Press **User Accounts** to access a page that displays a list of users with access to the AUI and, depending on permission level, allows editing of user accounts (see [User accounts on page 2-79](#)).

Select **Changeover** to access a page that allows setting of the main (active) exciter and setup of automatic exciter changeover (see [Changeover page on page 2-83](#)).

Press **User Settings** to access a page that allows network configuration, email configuration and alarm notifications, setting of Exgine parameters, SNMP configuration, capturing critical parameters, setting date and time, enabling and configuration of NTP servers and setting call sign (see [User settings on page 2-84](#)).

Press **Remote I/O** to access a page that allows assignation of remote digital inputs and outputs as well as the configuration of analog outputs (see [Remote I/O page on page 2-104](#)).

LOGS PAGE - VIEWING TRANSMITTER LOG

The Logs page allows you to review the transmitter's event logs to check the operational status, historical alarms, perform troubleshooting, or identify recent changes to transmitter controls. Press Logs (located on bottom panel) on any AUI window to open this page (see [Figure 2.8 on page 2-17](#)).

This section includes the following topics:

- [Viewing event logs on page 2-17](#)
- [Understanding the log manager window on page 2-19](#)
- [Filtering logs on page 2-20](#)
- [Copying logs on page 2-21](#)
- [Deleting logs on page 2-21](#)
- [Viewing the legend on page 2-24](#)

Figure 2.8: Log page

Date & Time
Fri Dec 14 2012
10:40:13

Transmitter (NAUTEL)
0 kW
98.00 MHz
Reflected 0 W Set Point 1.200 kW
Preset: Unknown Preset

Exciter
Active Exciter B
FM Modulation 8.99 % 100% 160 %

Transmitter Log

Log Manager

392 Matches Sorted by Time of Event Page 1/4

Device	Event	State	Severity	Time of Event
Controller	Local/Remote	REMOTE	⚠	Fri Dec 14 2012 09:44:03 490ms
Controller	Local/Remote	LOCAL	⚠	Fri Dec 14 2012 09:43:25 090ms
Controller	Local/Remote	REMOTE	⚠	Fri Dec 14 2012 09:43:02 760ms
Controller	Local/Remote	LOCAL	⚠	Fri Dec 14 2012 09:43:00 290ms
Controller	RF On/Off	🟢	⚠	Fri Dec 14 2012 09:07:28 860ms
Controller	RF On/Off	🔴	⚠	Fri Dec 14 2012 09:07:12 180ms
Controller	RF On/Off	🟢	⚠	Fri Dec 14 2012 09:07:04 410ms
Controller	AC Phase Loss 1	🔴	⚠	Thu Dec 13 2012 15:32:23 270ms
Controller	AC Phase Loss 3	🔴	⚠	Thu Dec 13 2012 15:32:23 270ms
Controller	All Supplies Failed	🔴	⚠	Thu Dec 13 2012 15:32:23 270ms
Controller	Fan PS B High Temp	🔴	⚠	Thu Dec 13 2012 15:32:23 270ms
Controller	Fan PS A High Temp	🔴	⚠	Thu Dec 13 2012 15:32:23 270ms

Navigation arrows on the right: first page, page-by-page, row-by-row, row-by-row, page-by-page, last page.

Bottom navigation: RF On, RF Off, Logged in as: Nautel, Menu, Status, Logs, Local Remote, Reset, Log Out.

VIEWING EVENT LOGS

The Logs page displays a “read only” chronological table of log events under the following column headings (see Figure 2.8):

- **Device** - identifies the origin device of the alarm (e.g., Controller, Exciter, or RF Module).
- **Event** - identifies the alarm name.
- **State** - indicates whether the alarm state is active (red bell) or cleared (green checkmark) and in some cases, indicates whether the RF was turned on or off. This column will also display which control state (Local or Remote) the transmitter is in, which preset index was selected, the frequency that is set and the power level.
- **Severity** - indicates how seriously the alarm affects transmitter operation.

Figure 2.9: Alarm Severity

= low (RF output not affected)



= medium (RF output may be reduced)



= high (RF output may be inhibited)

- **Time of Event** - identifies the day-of-the-week, date and time of the alarm event.

To navigate through the table, press the arrow keys on the right-side of the screen or use the scroll bar that appears when more than one page is available.

The table of log information can span over more than one page. The current page number is identified above the table on the right-side of the screen. For example, **Page 1/4** means that the displayed page is one out of a possible four pages. Press the **Page** button to reveal information about the pages.

You can access a more detailed listing of events and resolve any alarm issues via the **Log Manager** window. Pressing the **Log Manager** button on the **Logs** page will provide access to this window (see [Figure 2.9 on page 2-19](#)).

UNDERSTANDING THE LOG MANAGER WINDOW

The **Log Manager** window contains the functions that edit the logs listed in the **Logs** page. Press the **Log Manager** button to open a configurable window with the following display options identified by tabs across the top of the screen (see [Figure 2.9](#)):

- **Filter Logs:** Press to determine filter parameters by date and frequency.
- **Copy Logs:** Press to copy the selected logs (remote view only).
- **Delete:** Press to remove all selected logged events.
- **Statistics:** Press to display detailed information about an event(s).
- **Legend:** The **Legend** tab opens a “read only” display of alarm symbols to help you interpret the ones listed in the **Logs** page or in the **Statistics** window (see [Figure 2.14 on page 2-24](#)).

Each of these tabs, opens a secondary window or changes the active window options to suit the tab function.

Figure 2.9: Log Manager Window

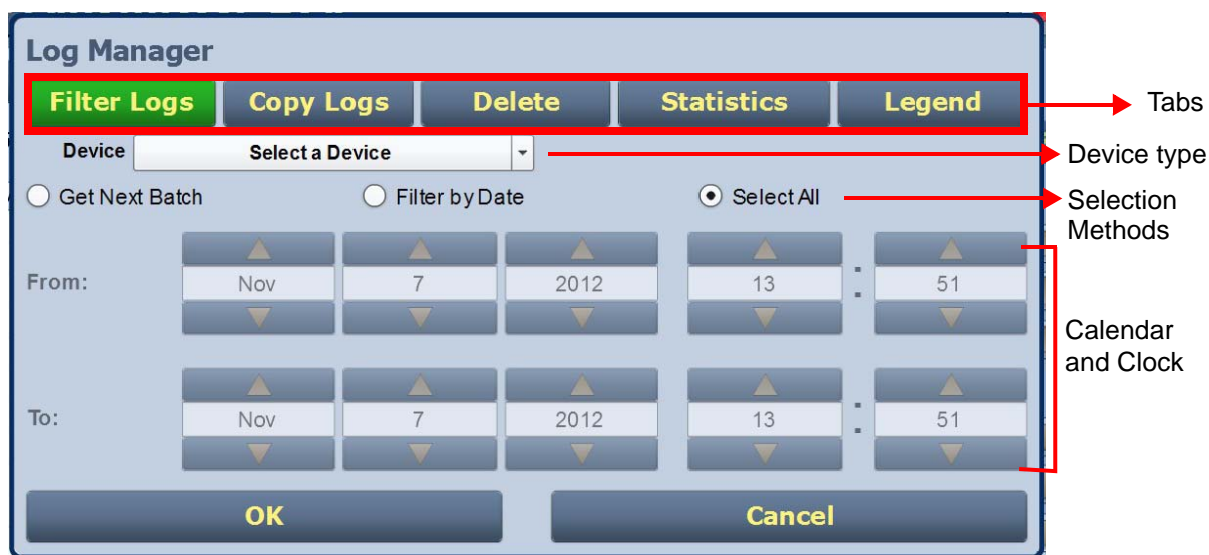

FILTERING LOGS

You can filter transmitter events based on their device or date by clicking the **Filter Logs** button in the **Log Manager** (see [Figure 2.10](#)).

Select a **Device** by pressing the **Select a Device** button to reveal the following event monitoring options in a drop-down menu:

- **No Selection** - displays all transmitter events (shown as **Select a Device**)
- **Controller** - displays controller events only
- **Exciter A** - displays exciter A events only
- **Exciter B** - displays exciter B events only
- **RF Module #** - displays applicable RF Module # events only

Activate a log mode option by selecting the radio button besides it:

- **Get Next Batch** - allows users to see log events in batches of 2000
- **Filter by Date** - activates the calendar portion of the screen and allows users to select a date range
- **Select All** - selects all logs for display

Press **OK** to accept the configuration or press **Cancel** to close and return to **Transmitter Log**.

Figure 2.10: Log Manager - Filtering Logs

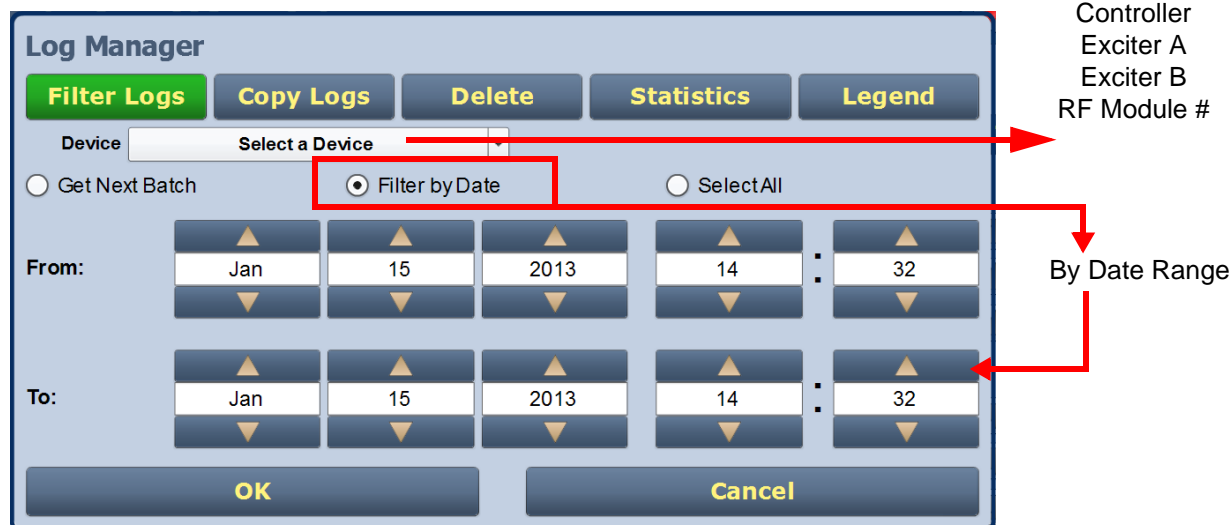

COPYING LOGS

You can create a copy of all the logs in the selected list while remotely logged into AUI (these are copied to the remote user's computer clipboard) by clicking on the **Copy Logs** button in the log manager (see [Figure 2.11](#)). You can paste the tab-delimited text copy of the logs into a text editing program such as Word, Excel, Notepad, etc. Press **OK** or **Cancel** to close and return to the Transmitter Log.

Figure 2.11: Log Manager - Copying Logs

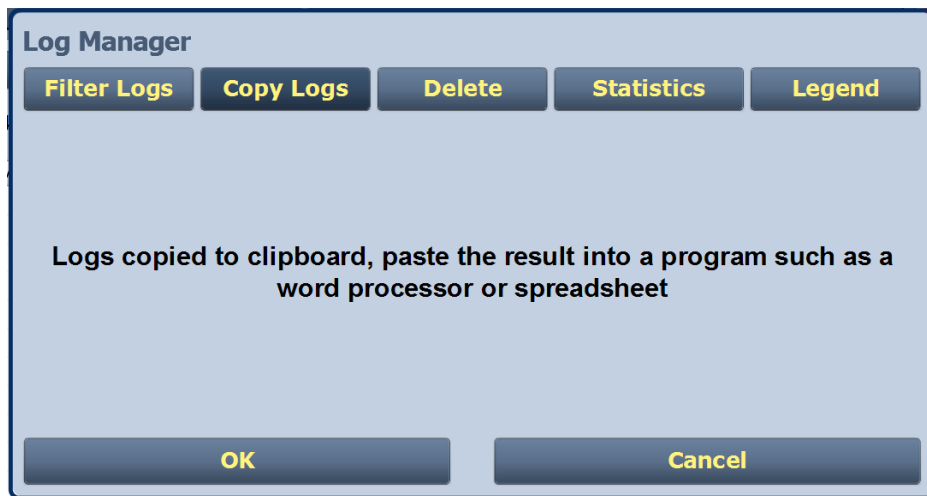

DELETING LOGS

You can delete all events or a selection of events by clicking on the **Delete** button in the log manager (see [Figure 2.12 on page 2-22](#)).

Delete by date - activates the calendar and clock (24-hour clock) where users can press the arrows to establish a date and time. Log events older than this date will be removed from the events list.

Delete All - removes all the logs in the list.

Press **OK** to accept the configuration or press **Cancel** button to close this window and return to the Transmitter Log.

Figure 2.12: Log Manager - Deleting Logs

The screenshot shows the 'Log Manager' interface. At the top, there are five buttons: 'Filter Logs', 'Copy Logs', 'Delete' (highlighted in green), 'Statistics', and 'Legend'. Below these buttons, there are five date and time selection fields: 'Month' (Mar), 'Day' (7), 'Year' (2012), 'Hours' (15), and 'Minutes' (23). Red arrows point from the 'Delete' button to each of these fields. Below the date and time fields, there are two radio buttons: 'Delete by date' (unselected) and 'Delete All' (selected). At the bottom, there are two buttons: 'OK' and 'Cancel'.

VIEWING LOG STATISTICS

Users can view statistical information on the events being displayed by clicking on the **Statistics** button in the **Log Manager** (see [Figure 2.13 on page 2-23](#)). The **Statistics** screen groups similar events that occurred within the filtered period as well as the time and date of the earliest and latest event occurrence for each event type. Use the scroll bar to move through the list or the up and down arrow buttons to the right of the scroll bar (if applicable). If the event log display spans more than ten rows, use the arrows on the side of the display to scroll to page up or down. The **Statistics** page will look similar to the **Logs** page display but has additional headings (see [Figure 2.13 on page 2-23](#)):

- **Device** - refers to the device that is associated with the alarm i.e. Exciter, Controller, RF Module, etc.
- **Event** - describes the alarm (e.g., Local/Remote switch)
- **Severity** - identifies the seriousness of the alarm.
- **# Events** - reveals the number of times the same alarm has occurred for the same device.

- **Earliest** - refers to the first time of an alarm occurrence.
- **Latest** - refers to the last time of an alarm occurrence.
 If an alarm has only one occurrence (i.e., **# Events** column is 1), then the time in the “**Earliest**” column will be the same as the time in the “**Latest**” column. If an alarm has more than one occurrence (e.g., **# Events** column is 4), then the “**Earliest**” column reveals the time of the first alarm (back in time), while the “**Latest**” column reveals the time of the last alarm (closest to the present).

Press **OK** or **Cancel** to close this window and return to the **Transmitter Log**.

Figure 2.13: Log Manager - Statistics

Device	Event	Severity	# Eve...	Earliest	Latest
Controller	Local/Remote	!	4	09:43:00 Fri Dec 14 2012	09:44:03 Fri Dec 14 2012
Controller	RF On/Off	!	14	14:05:24 Thu Dec 13 2012	09:07:28 Fri Dec 14 2012
Controller	Interlock Open	!!	3	14:06:40 Thu Dec 13 2012	14:43:41 Thu Dec 13 2012
Controller	IPA PS A AC Fail	!	7	14:01:58 Thu Dec 13 2012	15:32:23 Thu Dec 13 2012
Controller	IPA PS A High Temp	!	7	14:01:59 Thu Dec 13 2012	15:32:23 Thu Dec 13 2012
Controller	IPA PS A Failed	!	6	14:01:56 Thu Dec 13 2012	14:04:36 Thu Dec 13 2012
Controller	IPA PS B Failed	!	19	14:01:57 Thu Dec 13 2012	14:41:52 Thu Dec 13 2012
Controller	Fan PS A AC Fail	!	7	14:01:58 Thu Dec 13 2012	15:32:23 Thu Dec 13 2012
Controller	Fan PS B AC Fail	!	7	14:01:58 Thu Dec 13 2012	15:32:23 Thu Dec 13 2012
Controller	Fan PS A Failed	!	6	14:01:58 Thu Dec 13 2012	14:04:43 Thu Dec 13 2012

VIEWING THE LEGEND

The **Legend** tab is different from the other tabs. Press the **Legend** tab to display a window describing the meaning of the symbols that appear in the **State** and **Severity** columns of the **Logs** page (see [Figure 2.14](#)).

Press **OK** or **Cancel** to close this window and return to the **Transmitter Log**.

Figure 2.14: Log Manager - Legend

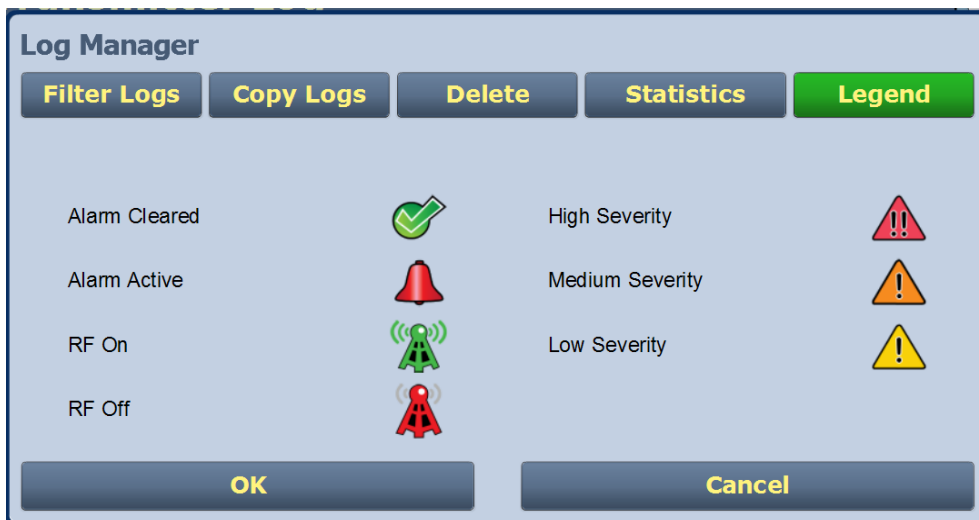

VIEWING TOOL MENU PANELS

The center area of the Home page screen displays up to 4 panels of instrument information. Users can choose which panels to display from 9 possible information panels (see Figure 2.15).

This section include the following topics:

- Describing instrument panel options on page 2-26
- Viewing instrument panels on page 2-27
- Instrument panel procedures on page 2-27
- Available instrument panels on page 2-30

Figure 2.15: Tool Menu Panel Options

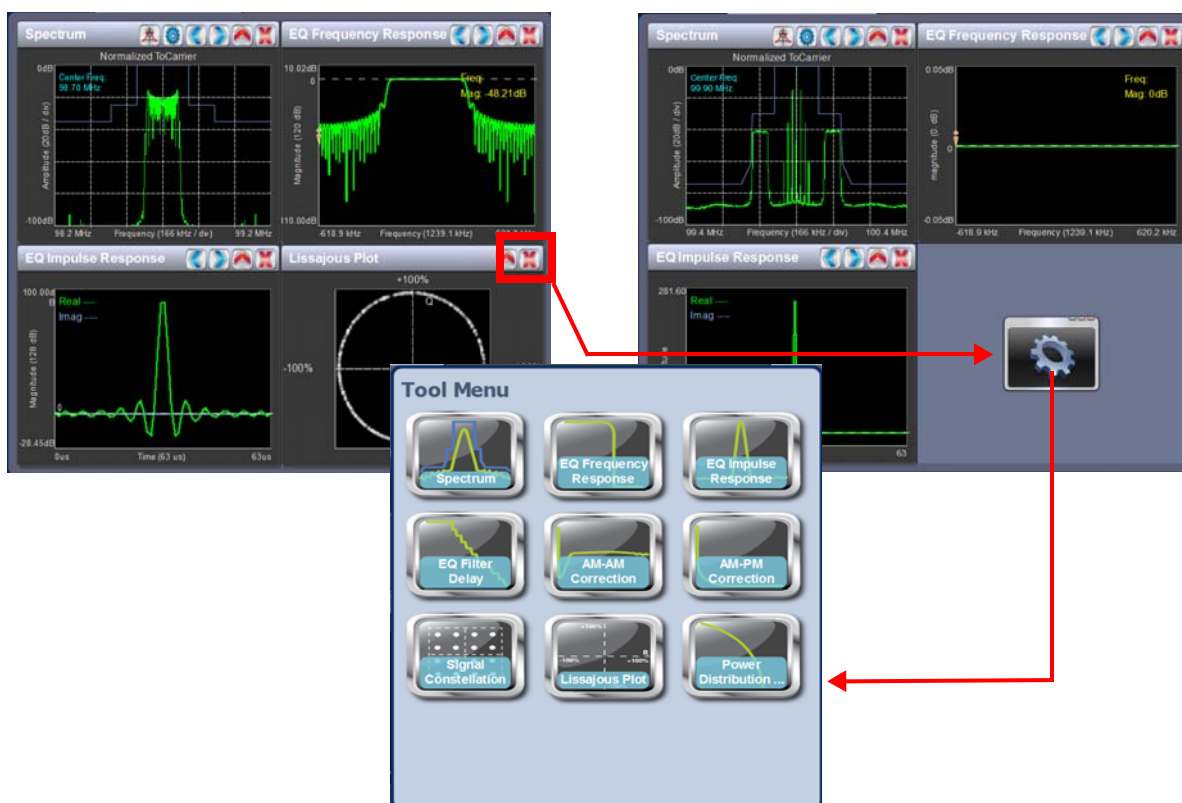

To view the instrument panel options , close an existing panel by pressing **X** (upper-right corner) and then press the icon in the blank space to open the Tool Menu. Select an icon to display that panel.

DESCRIBING INSTRUMENT PANEL OPTIONS

The following table describes instrument panel options:

Table 2.2: Tool Menu Panels

Tool	Description	Reference
Spectrum	Displays a spectrum analyzer, capable of monitoring the transmitter's RF output spectrum and various RF sections of the exciter. An audio spectrum analyzer is also available to allow viewing of the composite baseband.	See page 2-30
EQ Frequency Response	Displays the frequency response of the modulator's EQ filter.	See page 2-32
EQ Impulse Response	Displays the impulse response of the modulator's EQ filter.	See page 2-33
EQ Filter Delay	Displays the delay of the modulator's EQ filter across its bandwidth.	See page 2-34
AM-AM Correction	Displays the amplitude compensation being applied to the magnitude signal.	See page 2-35
AM-PM Correction	Displays the phase compensation being applied to the phase signal.	See page 2-36
Signal Constellation	Displays the phase and amplitude of the symbols being modulated within an OFDM sub-carrier as dots on a cartesian graph. Also displays timing, MER and data carrier information.	See page 2-37
Lissajous Plot	Displays a Lissajous figure that represents the resultant vector (magnitude and phase) for the applicable channels (either L and R or I and Q).	See page 2-38
Power Distribution	Displays a CCDF plot that indicates the probability of exceeding a given power level, based on the average power level. Aids in determining peak power capability.	See page 2-39

VIEWING INSTRUMENT PANELS

Each instrument panel has a menu bar that may be different from other panels (see [Figure 2.16](#)).

Figure 2.16: Instrument Panel Menus

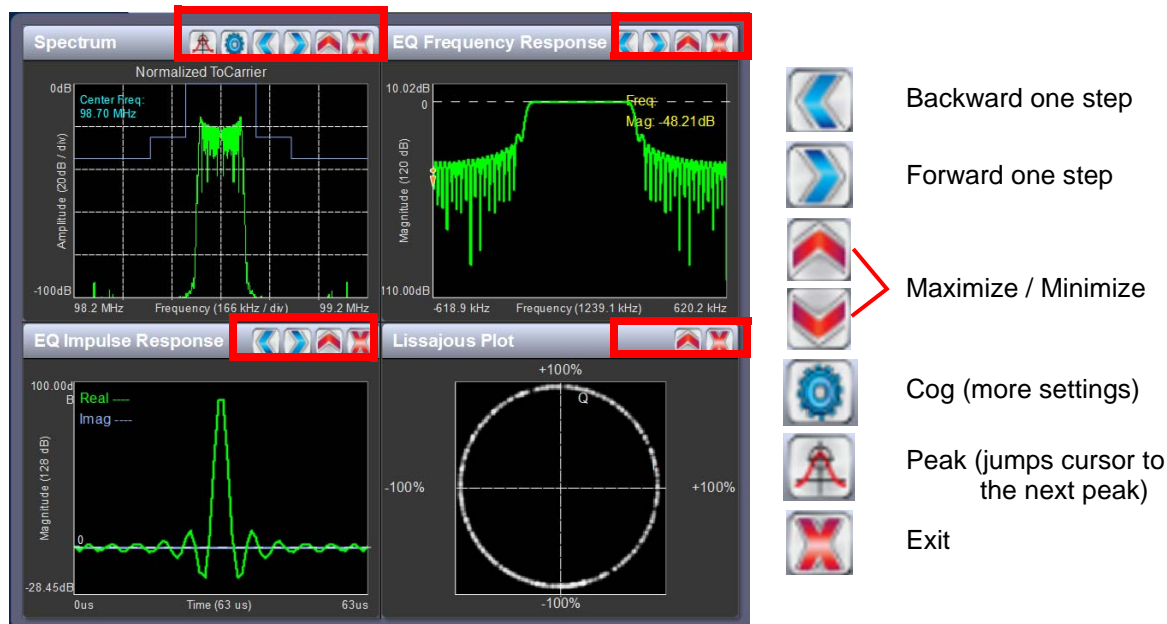

Each panel has a tool bar at the top of the display

INSTRUMENT PANEL PROCEDURES

Procedure to view instrument readings on the panel:

- To display a cursor in the panel, touch the screen where you want the cursor (see [Figure 2.17 on page 2-28](#)). The cursor position is noted in the upper, right-hand corner of the panel (e.g., frequency and amplitude for the spectrum analyzer). Touch in other areas of the instrument to provide a coarse adjustment of the cursor position.
- To make fine adjustments, use the backward and forward buttons (see [Figure 2.16](#)).

- To enlarge/reduce the instrument panel, use the maximize/minimize buttons. Some instrument displays show more information when maximized.
 - Most panels can be maximized to fill the whole screen, e.g., **EQ Impulse Response** (see [Figure 2.18 on page 2-29](#)).
 - Some panels display more information when maximized, e.g., **Signal Constellation** (see [Figure 2.19 on page 2-29](#)).
- To display additional settings in the **Spectrum Analyzer** panel, touch the “cog” button (see [Figure 2.16 on page 2-27](#)). Displays include resolution bandwidth, span, averaging rate and the actual measurement source (transmitter output, audio analyzer, etc.) that is being displayed. Touch the “peak” button (see [Figure 2.16 on page 2-27](#)) to place the cursor on the next successive peak in the spectrum.

Figure 2.17: Instrument Cursor Manipulation

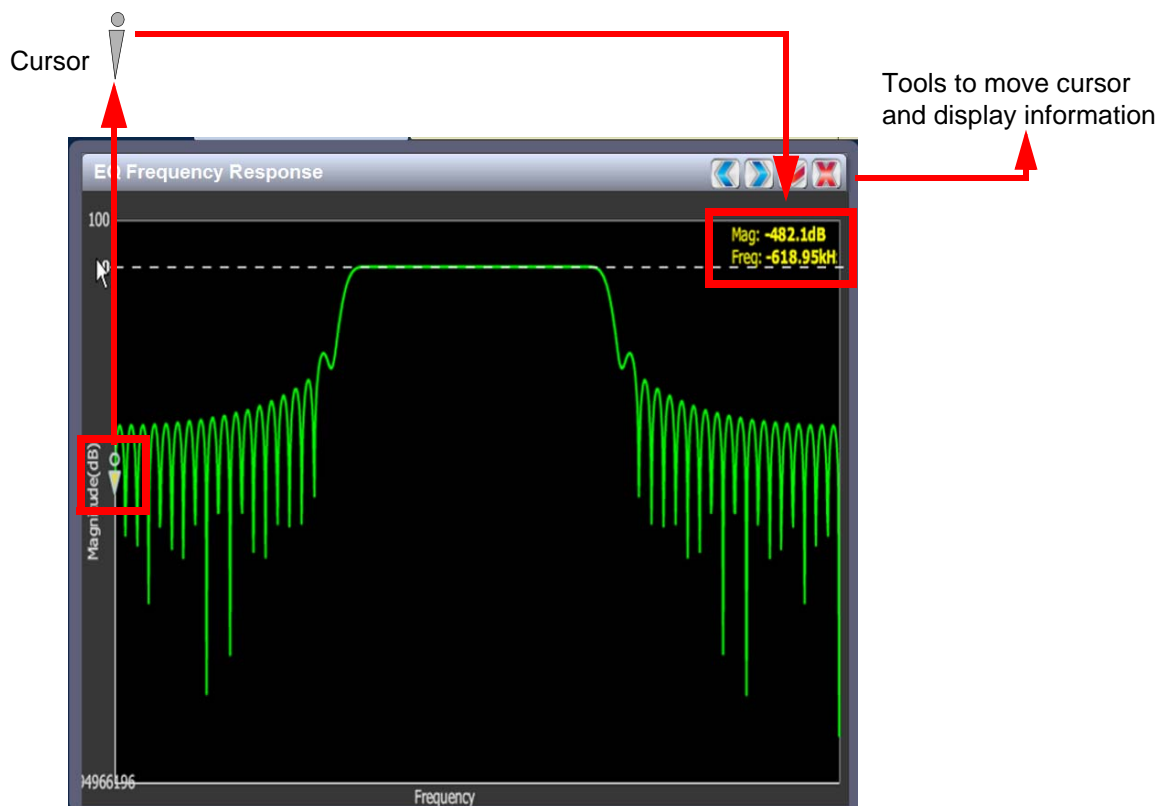

Figure 2.18: Instrument Panel - Expansion Example 1

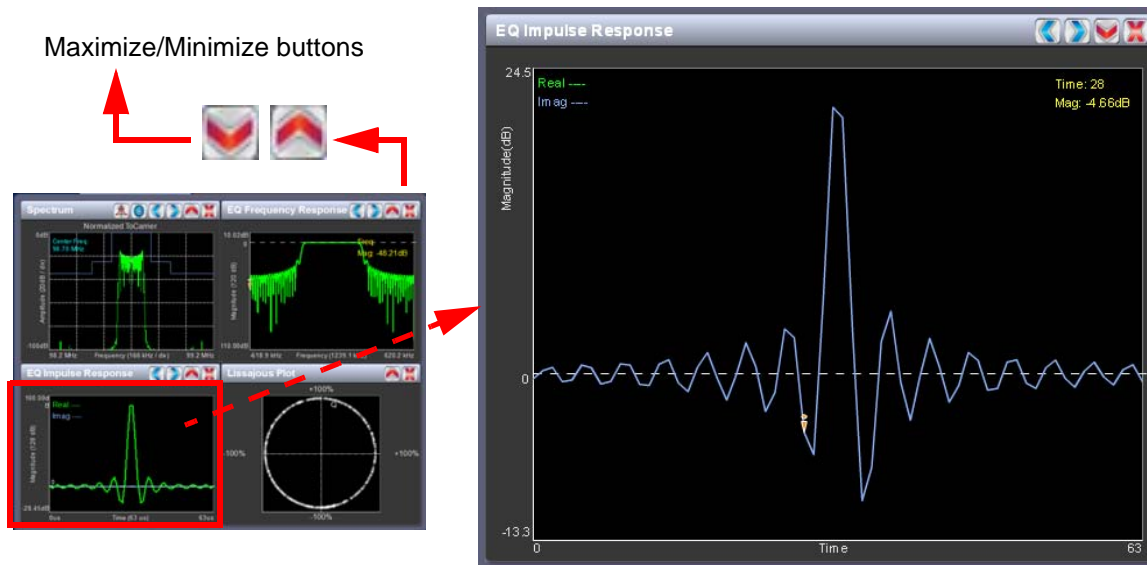
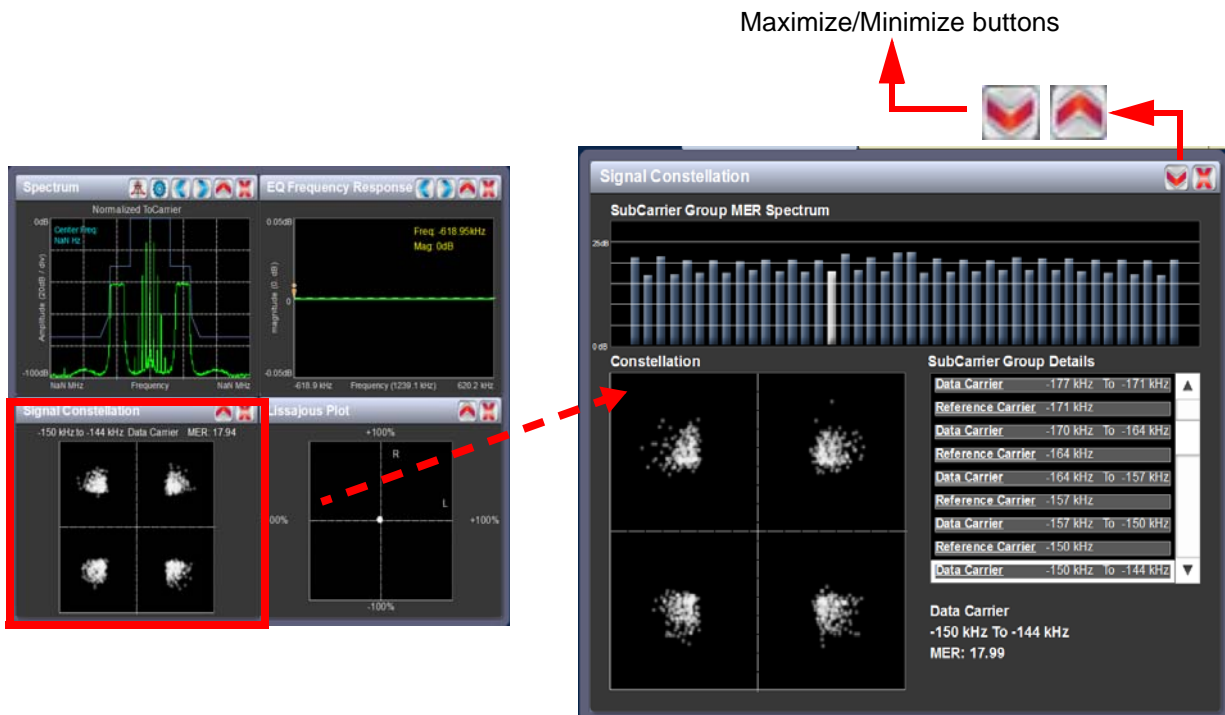

Figure 2.19: Instrument Panel - Expansion Example 2



AVAILABLE INSTRUMENT PANELS

SPECTRUM ANALYSER

See [Figure 2.20](#). The carrier level is normalized to its unmodulated carrier level at 0 dB. The graph center is always at the carrier frequency, as defined by the active preset’s Frequency value.

Masks are shown based on transmission mode and are defined by the latest versions of the following standards:

- IBOC: NRSC-5
- European Standard: ETSI EN 302 018-2
- FCC CFR 47, Part 73.317 and IC BETS-6e

 **Note:**
While very accurate, the spectrum analyzer may display artifacts (spurs) as some operating carrier frequencies that are a function of the analyzer and are not actually present on the output of the transmitter. If these spurious emissions are observed on the spectrum analyzer, Nautel recommends that a calibrated, external spectrum analyzer be used to verify the presence of spurs.

Touch on the panel to display a cursor in the approximate area. The cursor position (frequency and amplitude) is noted in the upper, right-hand corner of the panel. Touch other areas of this instrument panel to provide a coarse adjustment of the cursor position.

Figure 2.20: Spectrum Analyzer

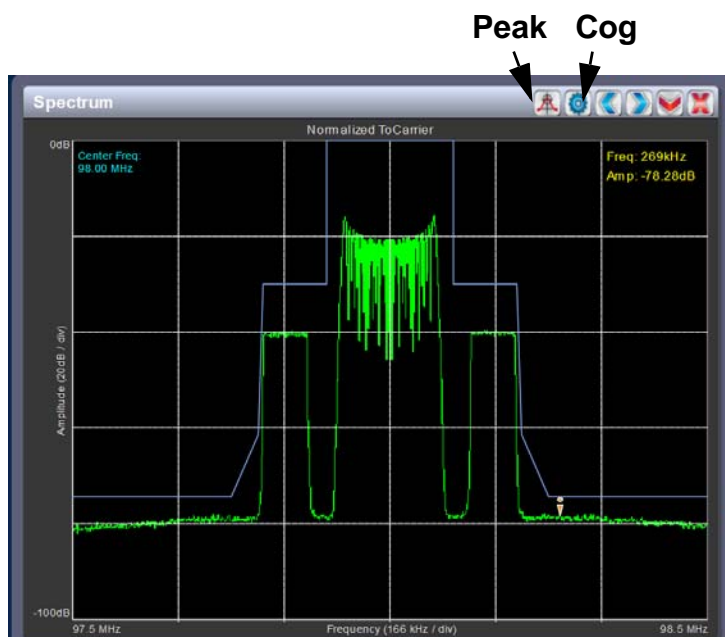

Use the left and right buttons to make fine adjustments.

Use the maximize or minimize buttons as required.

Use the “peak” button to place the cursor on the next successive peak (moving left to right) in the spectrum.

Use the “cog” button to gain access to spectrum settings (see [Figure 2.21](#)) such as:

- **Resolution Bandwidth:** determines the FFT bin size or the smallest frequency that can be resolved. Allowable range is 75 - 10,000 Hz. Default setting is 1000 Hz.
- **Span:** determines the start and stop frequencies of the analyzer with the carrier frequency always at the center. Allowable range is 10 - 1200 kHz. Default setting is 1000 kHz.
- **Averages:** determines the number of averages that the analyzer performs per sweep. Press the **Clear Averaging** button to restart the averaging process. Allowable range is 0 - 100 kHz. Default setting is 19.
- **Measurement Source:** determines the source of the spectrum plot (transmitter output, audio analyzer, etc.) that is being displayed. Selecting **TX Output** uses the exciter’s RF sample feedback signal to display the RF output spectrum. Selecting **Internal (Post EQ)** displays the signal that will be produced by the exciter. Selecting **Internal (FM)** uses the exciter’s RF signal, before being equalized (if applicable). Selecting **MPX** shows the composite baseband signal.

Figure 2.21: Spectrum Settings

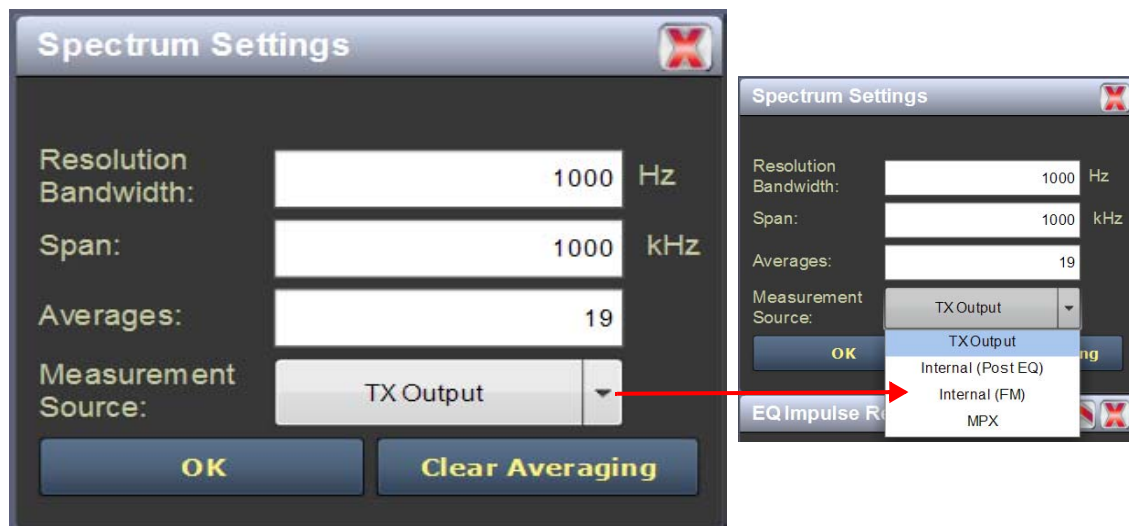

EQUALIZER SCREENS

The NV30/NV40's exciter includes a fixed equalizer to optimize audio performance. There are three EQ instrument panels available in the Tool Menu - EQ Frequency (see Figure 2.22), EQ Impulse Response (see Figure 2.23 on page 2-33) and EQ Filter Delay (see Figure 2.24 on page 2-34).

Coefficients are selected based on channel frequency. All frequencies shown are relative to the channel frequency.

Figure 2.22: EQ Frequency Response

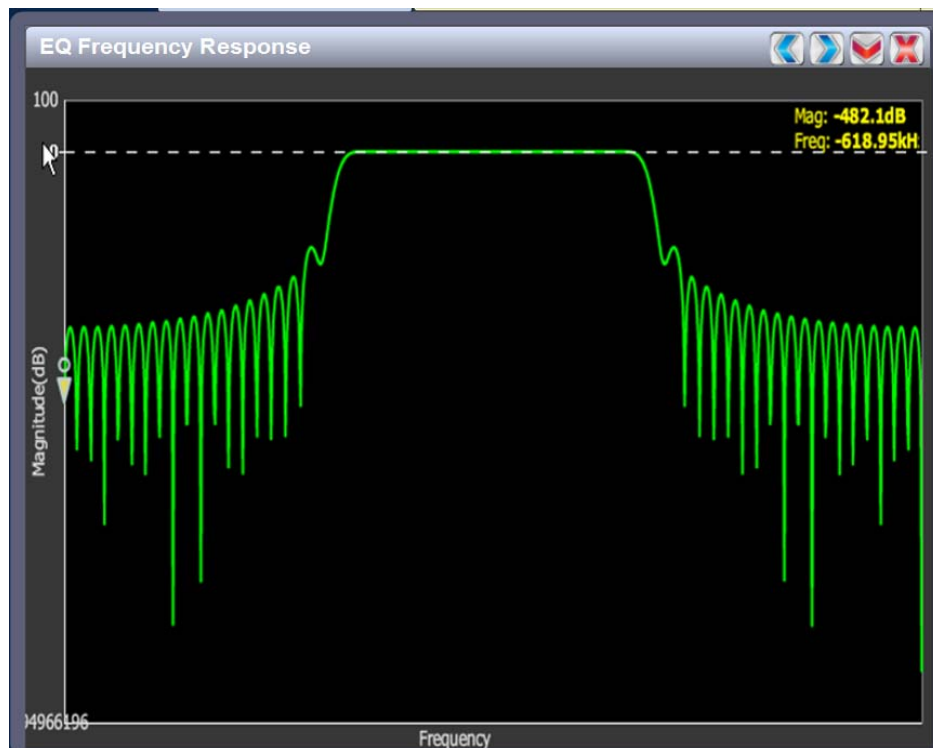

EQ FREQUENCY RESPONSE

See Figure 2.22. This panel displays the frequency response of the active exciter's EQ filter. The panel displays the gain of the filter with respect to the magnitude and frequency of the modulating signal. A dashed line is displayed at the 0 dB level.

This tool is useful for installations featuring filter coefficients loaded to compensate for a channel combiner response.

Touch on the panel to display a cursor in the approximate area. The cursor position (magnitude and amplitude) is noted in the upper, right-hand corner of the panel. Touch in other areas of this instrument panel to provide a coarse adjustment of the cursor position.

Use the left and right buttons as fine adjustments. Use the maximize or minimize buttons as required.

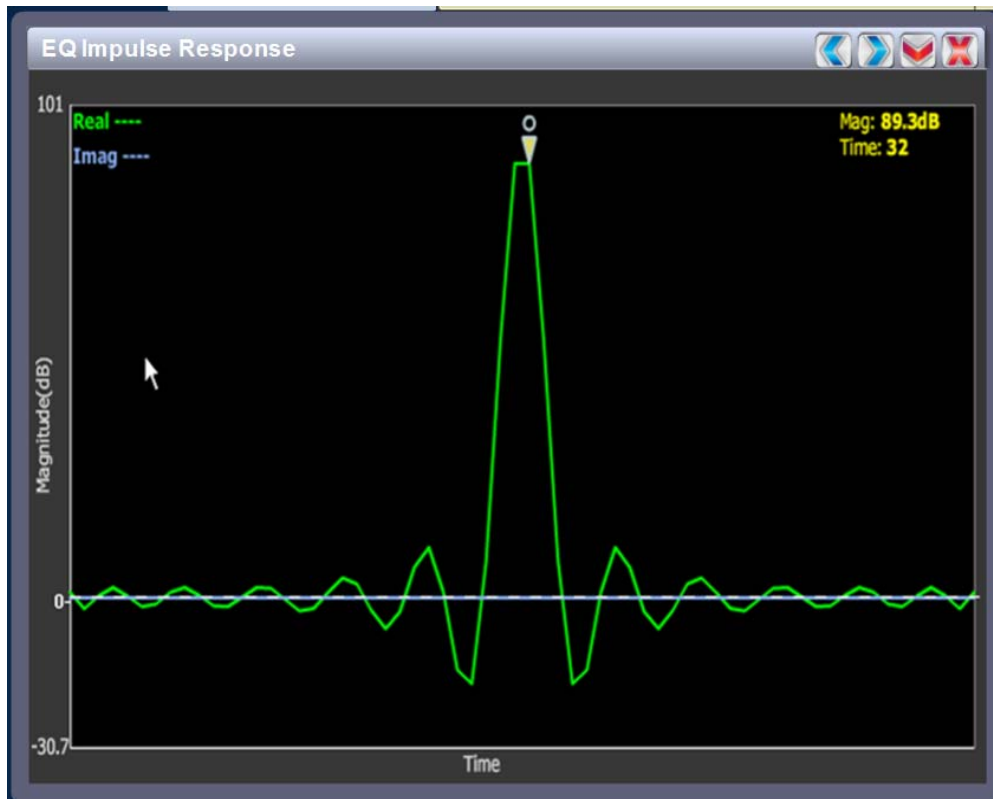
Figure 2.23: EQ Impulse Response

EQ IMPULSE RESPONSE

See [Figure 2.23](#). This panel displays the impulse response of the modulator's EQ filter in the time domain. This is a static display tool so the screen image is not fluid and will not change.

Touch on the panel to display a cursor in the approximate area. The cursor position (magnitude and time) is noted in the upper, right-hand corner of the panel. Touch in other areas of this instrument panel to provide a coarse adjustment of the cursor position.

Use the left and right buttons as fine adjustments.

Use the maximize or minimize buttons as required.

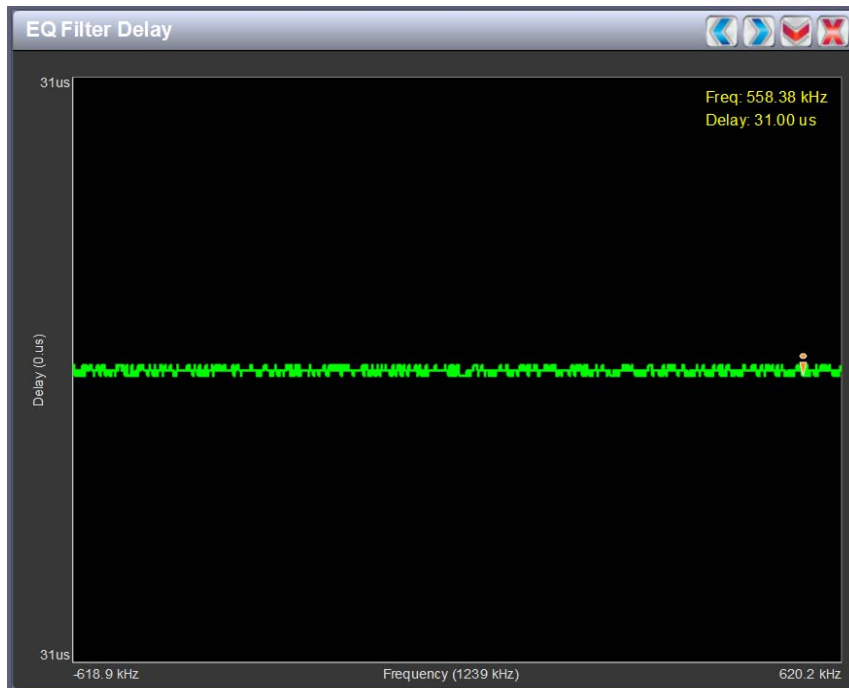
Figure 2.24: EQ Filter Delay

EQ FILTER DELAY

See [Figure 2.24](#). This panel displays the delay of the modulator's EQ filter across its bandwidth.

Touch on the panel to display a cursor in the approximate area. The cursor position (delay and frequency) is noted in the upper, right-hand corner of the panel. Touch in other areas of this instrument panel to provide a coarse adjustment of the cursor position.

Use the left and right buttons as fine adjustments.

Use the maximize or minimize buttons as required.

AM-AM AND AM-PM CORRECTION SCREENS

When the transmitter is operating with digital carriers, the exciter linearizes the transmitter's RF drive signal by performing adaptive pre-correction. There are two correction parameters - **AM-AM Correction** (see [Figure 2.25](#)) and **AM-PM Correction** (see [Figure 2.26 on page 2-36](#)), which can be viewed as an instrument panel.

Figure 2.25: AM-AM Correction

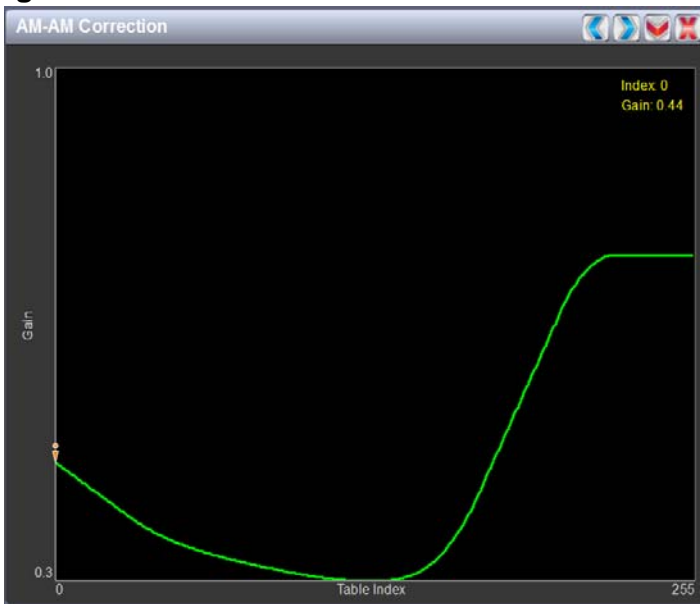

AM-AM CORRECTION

This panel displays the amplitude correction being applied to the RF drive signal in order to compensate for the transmitter amplitude (gain) response, which is non-linear. The x-axis represents the signal amplitude and the y-axis represents the gain correction applied for a given amplitude value. A look up table (LUT) index value of 0 represents low transmitter output power (RF drive). A LUT index value of 255 represents the maximum transmitter output power (RF drive).

The LUT curve can show that at low transmitter output power, more RF drive power is required to connect for low final stage amplifier gain - the curve sharply increases as it drops to 0 table value. (This low gain can also be overcome using additional bias, however pre-correction is more efficient.) Equally, the curve could also increase sharply at the top end of the table, suggesting that high RF drive power (gain) is required to connect for low gain at final stage amplifiers (PA compression peak limiting). It is technically the inverse of the transmitter's power amplifier gain response.

Touch on the panel to display a cursor in the approximate area. The cursor position (Gain and LUT index) is noted in the upper, right-hand corner of the panel. Touch in other areas of this instrument panel to provide a coarse adjustment of the cursor position. Use the left/right fine adjustment buttons and the maximize/minimize buttons as required.

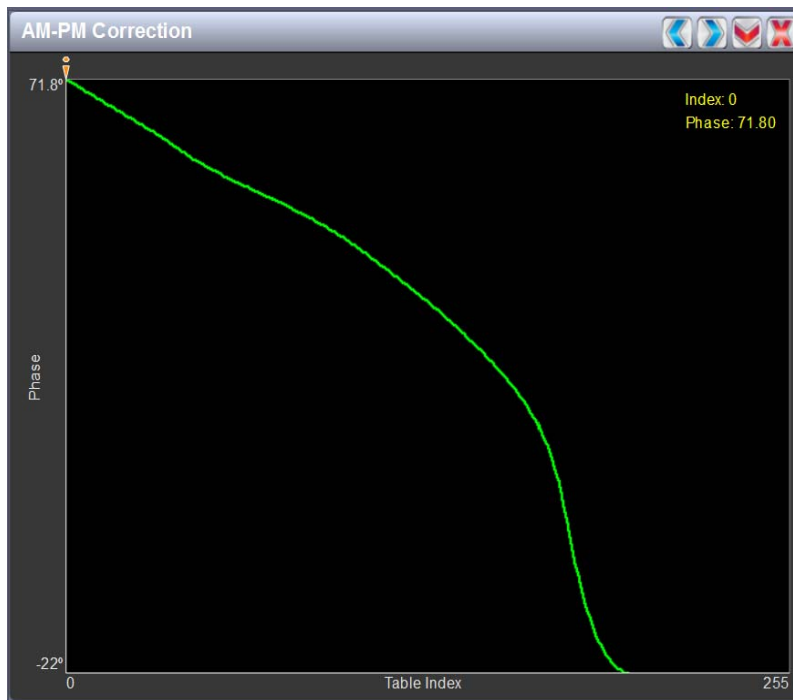
Figure 2.26: AM-PM Correction

AM-PM CORRECTION

This panel displays the phase correction being applied to the RF drive signal in order to compensate for the transmitter's (IPA +PA stage) phase non-linearity versus the output power. For example, in [Figure 2.26](#) the transmitter output power is low, so the curve in the plot shows positive phase correction. Inversely, a negative phase correction will be displayed in the plot given high output power levels. This correction is represented on the plot via the x-axis (table index value of between 0-255). The y-axis represents the phase shift correction applied for a given amplitude value.

Touch on the panel to display a cursor in the approximate area. The cursor position (phase and LUT index) is noted in the upper, right-hand corner of the panel. Touch in other areas of this instrument panel to provide a coarse adjustment of the cursor position.

Use the left and right buttons as fine adjustments.

Use the maximize or minimize buttons as required.

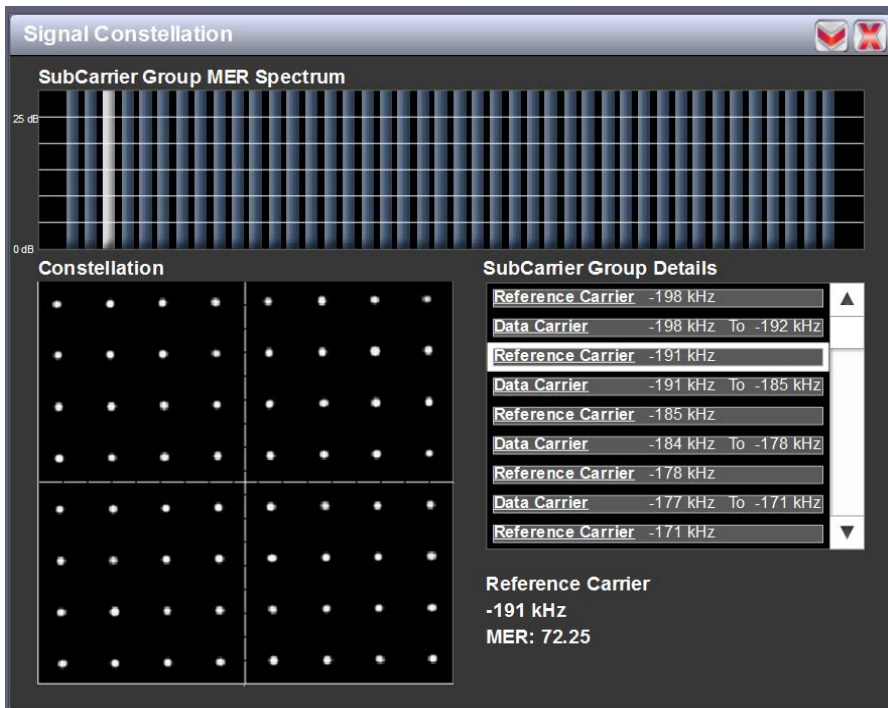
Figure 2.27: Signal Constellation

SIGNAL CONSTELLATION

See [Figure 2.27](#). The exciter constantly measures the transmitter signal and performs basic demodulation of the digital carriers. The **Signal Constellation** panel displays the phase and amplitude of the symbols being modulated within an OFDM sub-carrier as dots on a cartesian graph. There are separate screens for each sub-carrier. Typically, the dots will be grouped together around the ideal data points. When the transmitter is on, the signal constellation display is representative of the transmitter output. When the transmitter is off, the display is representative of the forward path that will be transmitted.

Sub-carrier group information is shown in the lower, right section of the screen. Displayed information includes the sub-carrier group name, the bandwidth that the selected carrier group occupies and the modulation error ratio (MER) for the selected carrier group. MER quantifies the performance of the transmitted digital signal as the ratio between the RMS power of the ideal signal and the RMS power of the received signal's error vector. A higher MER value is characteristic of a smaller error, and therefore a higher quality signal. There is a NRSC minimum requirement of a MER value of no less than 14 dB.

Use the scroll bar to select a higher or lower sub-carrier for viewing. Some sub-carriers are for timing and synchronization. Others are modulated with data/content. Use the maximize or minimize buttons as required.

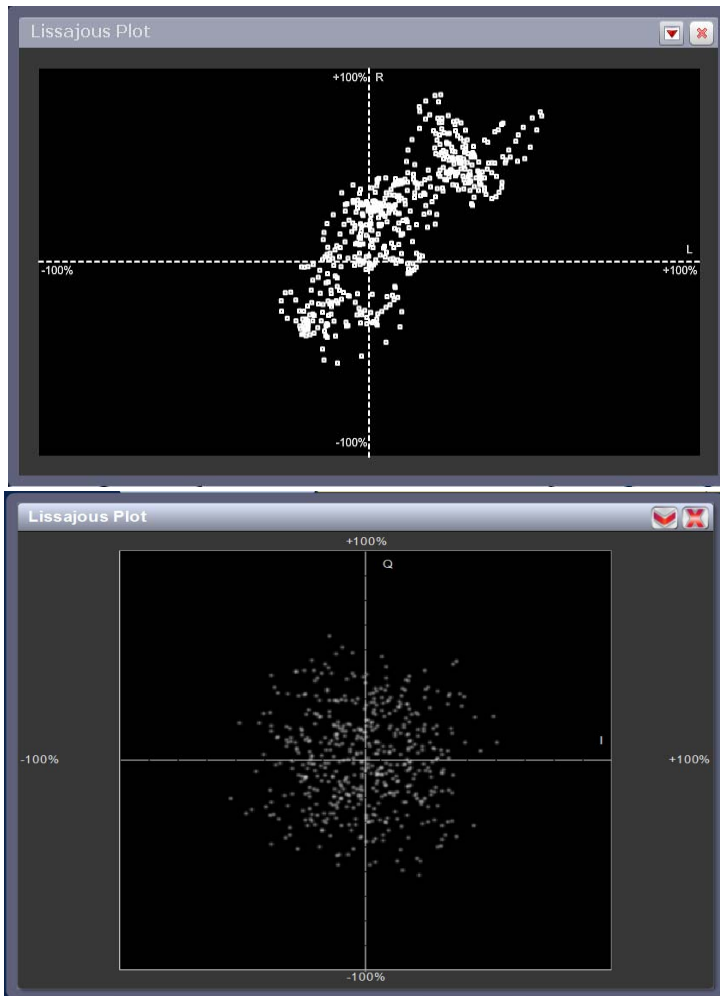
Figure 2.28: Lissajous Plot**L and R mode****I and Q mode**

LISSAJOUS PLOT

See [Figure 2.28](#). This panel displays a Lissajous figure that represents either L (left) and R (right) audio content or a representation of the FM modulated signal [I (in-phase) and Q (quadrature)]. I and Q will be automatically selected unless the transmitter is operating in stereo mode or not operating in IBOC. Left and right audio content is displayed for all other audio sources.

The plot consists of a group of sequential samples to allow signal analysis. In L and R mode, the L+R portion of the signal tends to dominate the plot, resulting in the majority of samples appearing in the lower, left and upper, right quadrants. In I and Q mode, signals that are of equal frequency and 90 degrees out-of-phase result in a circular display.

Use the maximize or minimize buttons as required..

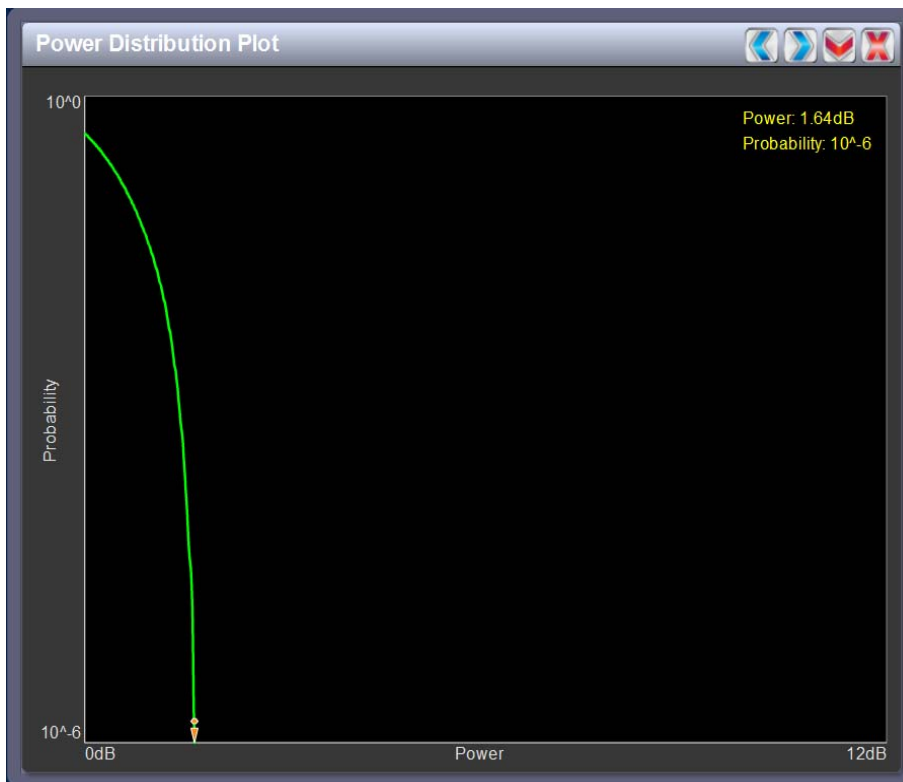
Figure 2.29: Power Distribution Plot

POWER DISTRIBUTION PLOT

See [Figure 2.29](#). The exciter measures the relative power levels of the signal and determines the probability of exceeding a given power level, relative to the average power. The data is plotted in the **Power Distribution Plot** as a CCDF (complementary cumulative distribution function). The x-axis displays the relative power level in dB, with the reference representing the average power. The average power is 0db. The y-axis displays the probability of exceeding that power level. This plot can be used to assess the distribution of a given signal, and provides an indication of the amount of peak power capability required from the transmitter in order to prevent peak clipping/distortion of the output signal.

Touch on the panel to display a cursor in the approximate area. The cursor position (power gain and probability index) is noted in the upper, right-hand corner of the panel. Touch in other areas of this instrument panel to provide a coarse adjustment of the cursor position.

Use the left and right buttons as fine adjustments.

Use the maximize or minimize buttons as required.

VIEWING REAL-TIME METERS

The AUI can be used to display metered parameters on the Home page (see [Figure 2.30](#)), if selected individually from the Meters List View page or saved in a meter list layout and set to default.

This section includes the following topics:

- [Describing the meter display on page 2-40](#)
- [Accessing meter information on page 2-41](#)
- [Identifying meter information on a specific sub-device on page 2-42](#)
- [Saving a meter list on page 2-43](#)

Figure 2.30: Meters Page

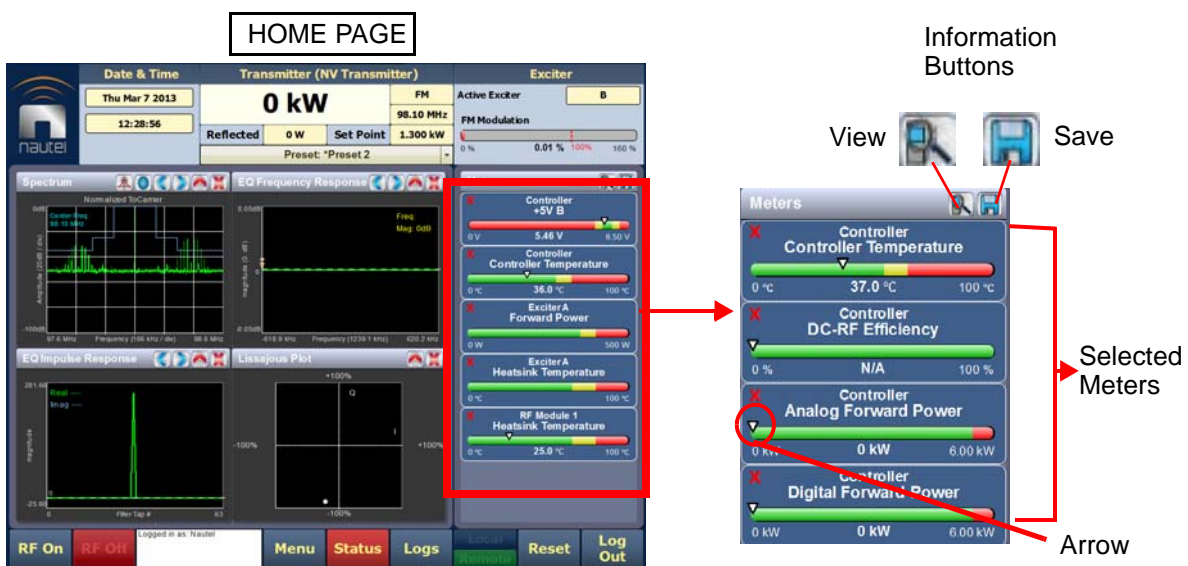

DESCRIBING THE METER DISPLAY

The meters displayed in the AUI represent the active meters selected for display. Each meter is a colour-coded bar with minimum and maximum values (see [Figure 2.30](#)). The current value for a meter is indicated by an arrow on the colour-coded bar, as well as a numeric value below the meter.

- A parameter value in the green section of a meter bar indicates the parameter is within the range for normal operation.

- A parameter value in the yellow section (as applicable) of a meter bar indicates the parameter is still within an operational range, but is approaching design limitations.
- A parameter value in the red section of a meter bar indicates the parameter is outside normal operating conditions.

ACCESSING METER INFORMATION

Procedures for accessing and editing information in the **Meters** section of the AUI screen:

- To delete a meter from the Home page, press **X** in the **Meters** window (Figure 2.31).
- To review all the meter options, press the meter list view shortcut button (magnifying glass) at the top of the meters panel (see Figure 2.31). This will open the **Meter List View** window.
- On the **Meter List View** screen users can see all relevant meters of a sub-device. Select the sub-device in question under the **Transmitter Layout** column and the **Relevant Meters** column will be populated. The desired **Meters** can now be selected.

Figure 2.31: Meters List View Window (Exciter A shown)

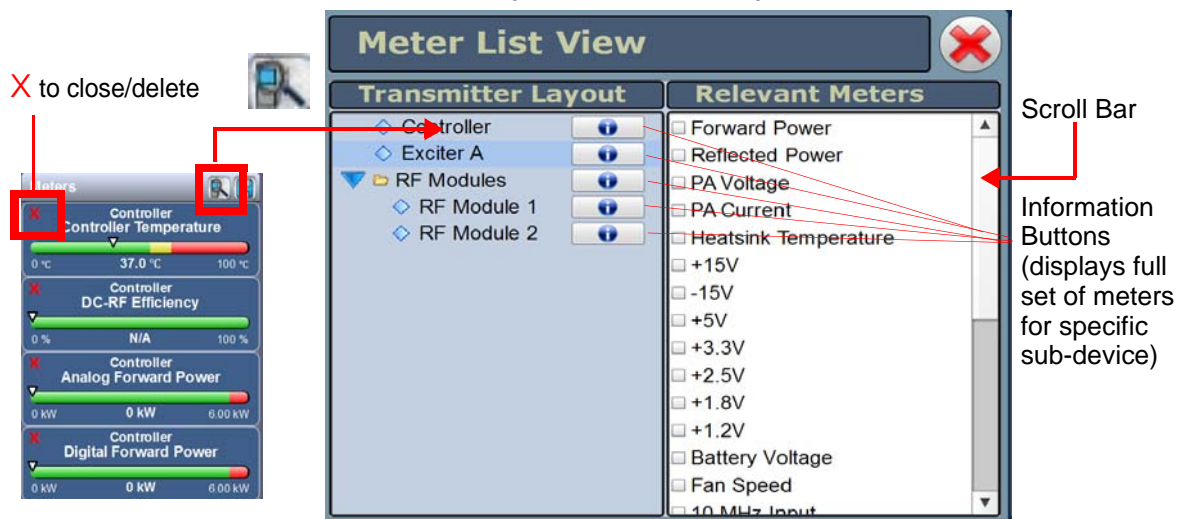

IDENTIFYING METER INFORMATION ON A SPECIFIC SUB-DEVICE

- Open the **Meters List View** window and select one of the desired transmitter sub-devices.
 - Controller**
 - Exciter A**
 - Exciter B**
 - RF Modules** - Multiple modules supported
- Under **Transmitter Layout**, press the information button (i) beside a device type. This will open an information window in tabular format (see [Figure 2.32](#)).

Note:
 When a meter value is updated, a blue box briefly appears around that value. Typically, updates occur every one or two seconds.

- To choose individual meters for display in the **Meters** window of the Home page: Select the device type name in the **Transmitter Layout** panel and select the checkbox next to the desired meters shown in the **Relevant Meters** panel (see [Figure 2.31 on page 2-41](#)). If the **Relevant Meters** panel contains more than one page of information, use the scroll bar (right-side) to find the desired meter.

Figure 2.32: Meters - Information (Device type Controller shown)



SAVING A METER LIST



Note:

Meter lists are associated with user accounts. Lists saved in this screen are only displayed in the current user account. Setting a list as default will define the meters that will appear when logging into the current account (or after an ac power interruption in the local AUI if this is the default user account).

To save meter specifics for display on the Home page:

Open the **Meter List Save** window from the Home page using the floppy disk button (Figure 2.33).

- Press **Save As** to save the currently displayed meters. Enter a name in the **Layout Name** entry box and press **OK**.
- Press **Delete** to discard the selected meter list.
- Press **Set Default** to set the selected meter list as the default for the current user account. The * symbol shows the default.
- Press **Save** to overwrite the selected meter list with the currently displayed meters.
- Press **Load** to display the meters saved under the currently selected meter list in the **Meters** panel on the right-hand side of the Home page.

Figure 2.33: Meter List Save Window

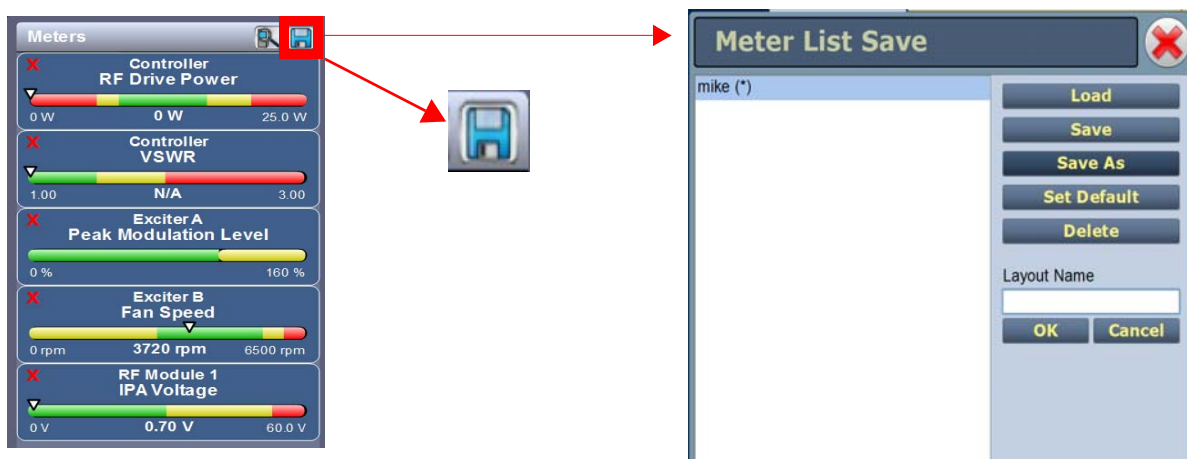

PRESETS - EDITING OPERATIONAL SETTINGS

The **Presets** page (see [Figure 2.34](#)) allows users with the appropriate permissions to view operational data (power level, frequency, mode, program input characteristics), plus create and control preset settings. Users can create up to 62 presets or edit existing presets. To view the **Presets** page, select **Presets** in the **Menu** page.

This section includes the following topics:

- [Editing or creating presets on page 2-45](#)
- [Loading presets on page 2-46](#)
- [Understanding the preset tabs on page 2-47](#)

Figure 2.34: Presets Page - General Tab

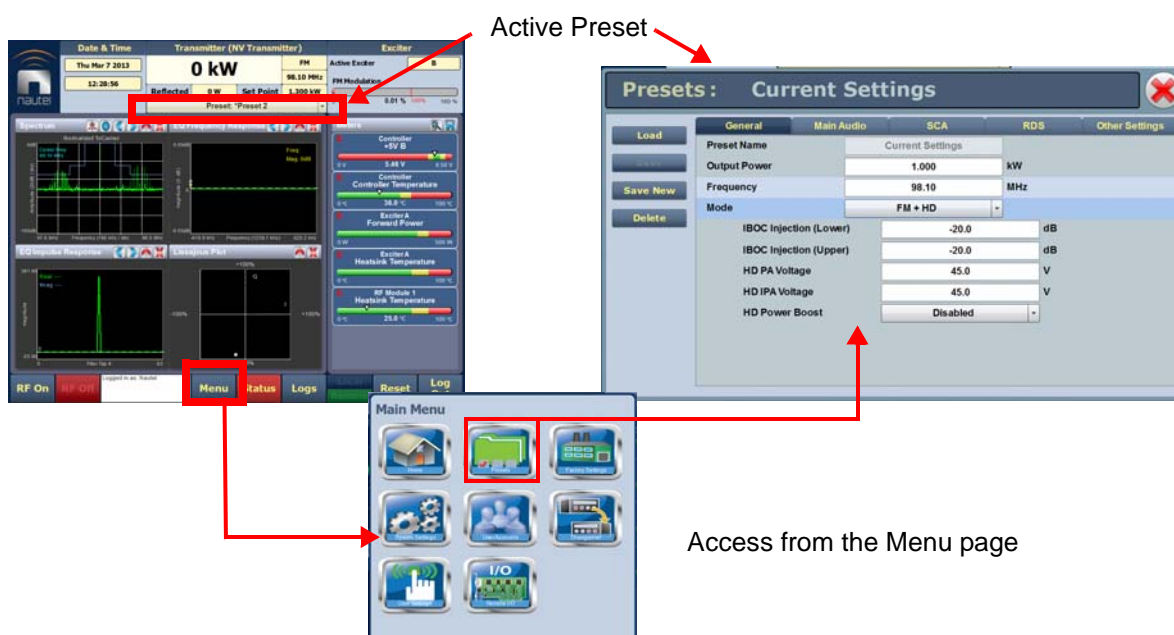

Note:
 When asked to enter a value in a field, an error message may appear (red text at the bottom of the screen) showing the limits of the requested value. Re-enter the desired value, ensuring it falls within the limits shown.
 For example: **Output Power - Valid values: 0.15kW to 5.5kW**

EDITING OR CREATING PRESETS

When a presets page is opened from the menu, (for example see [Figure 2.34 on page 2-44](#) or [Figure 2.37 on page 2-52](#)), the **Current Settings** of the transmitter are displayed. They define the current operational state of the transmitter. **Current Settings** can be edited and then immediately activated by pressing the **Save** button.

To edit a saved preset, you must load that preset from the **Presets** page (see [Loading presets on page 2-46](#)). If the edited preset was active before it was edited, saving the preset will update the preset, but the **Current Settings** will not change. To update the operation of the transmitter, re-activate the preset through the top banner (see [Activating presets on page 2-46](#)).

In the top banner (see [Activating presets on page 2-46](#)), an asterisk (*) appears next to the preset name when the **Current Settings** have changed since the last preset was loaded. **Current Settings** are not saved through an ac power cycle; when the transmitter recovers from an ac power loss, it loads the preset that was last activated.

On the **Presets** page, an asterisk (*) appears next to the preset name in the header when there are unsaved changes to the preset.

When changes are complete, press the **Save** button and then press the **Save Preset** window's **Save** button to enable the changes. If you are creating a new preset, you can also enter a new name (e.g., Preset 4 - IBOC) in the preset window before clicking the **Save** or **Save New** button.

Parameters that can be edited are discussed in detail in [Understanding the preset tabs on page 2-47](#).

To remove a preset, select it and press the **Delete** button.

To ignore any changes, press **Cancel** to return to the **Presets** page.

**Note:**

If you change an FM+HD or HD preset, particularly its power level or frequency, it is possible to optimize the transmitter's performance by adjusting the HD PA Volts value in the Mode section of the Presets screen. For additional information see [Improving transmitter performance for IBOC presets on page 4-12](#) of this manual.

LOADING PRESETS

When first entering the **Presets** page, the current “active” preset is displayed (see [Figure 2.34 on page 2-44](#)). If the current preset is not the desired one, use the **Load** button on the left-side of the AUI to call up a window containing a list of available presets.

Select the desired preset and press the **Load** button to view or enable editing of the preset. Press the **Delete** button to delete the selected preset. Users cannot delete the current "active" (operational) preset or any preset that is referenced in the **Remote I/O** menu as either a remote input or output. Those links in the **Remote I/O** menu must be deleted before the associated preset can be deleted. Press **Cancel** to return to the **Presets** page.

ACTIVATING PRESETS

In the Transmitter block in the AUI's top banner, press the bar that contains the active preset name and the drop-down arrow (see [Figure 2.35](#)). The **Activate Preset** window will appear, which contains a list of all preset options. Press and highlight the desired preset and press the **Activate** button to enable the preset as the transmitter's active preset. Press the **Cancel** button to close this window.

Figure 2.35: Activating Presets

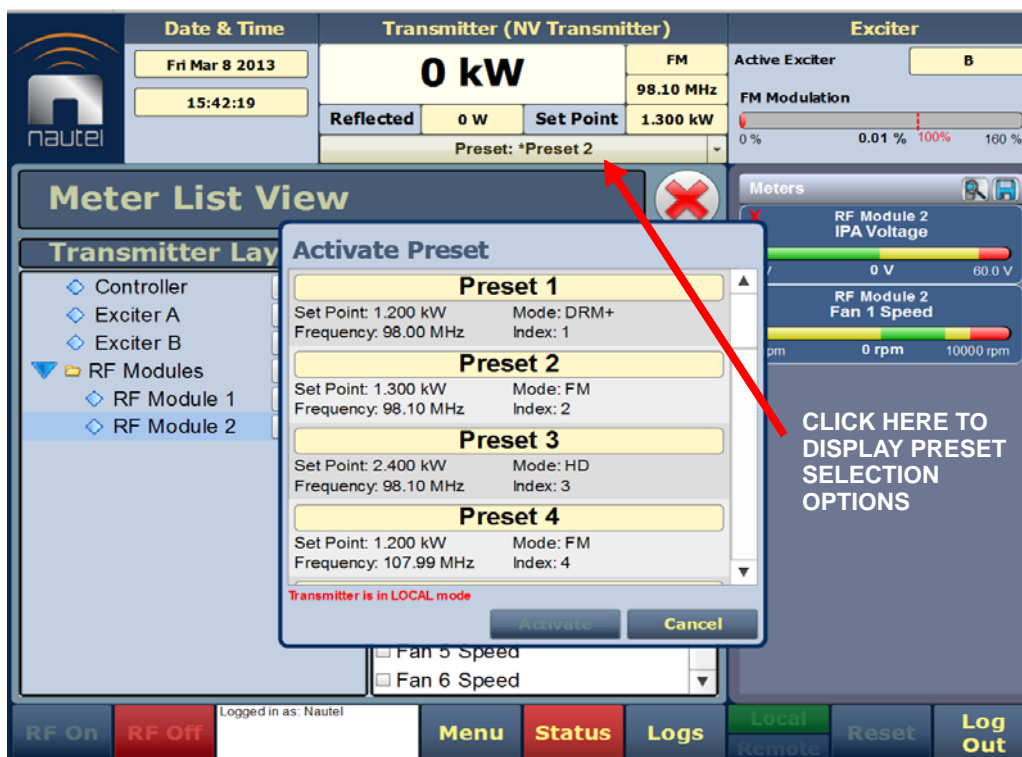

UNDERSTANDING THE PRESET TABS

The **Presets** page consists of tabs across the top with functions on the left-side and parameters displayed in the center and right-side of the window. A separate display appears for each of the following tabs:

General - (see [Figure 2.34 on page 2-44](#))

- **Preset Name** This field identifies the current preset settings. Users must load a preset to directly edit this field (see [Activating Presets on page 2-46](#)).
- **Output Power** Set the output power level (in kW). Output power limits are a function of the transmitter mode of operation (see Table 1-1 of the Pre-Installation Manual for RF output power ratings for this transmitter).
- **Frequency** Set value. Valid frequencies are between 87.00 and 108.00 MHz.
- **Mode** Set the overall transmission mode. Available options are:
 - **FM:** an analogue only mode, transmits a carrier, frequency modulated with audio.
 - **HD:** all digital mode; this mode transmits the upper and lower digital sidebands of OFDM IBOC carriers. HD transmitter is typically high-level combined (coupler or spatial) with a paired FM only transmitter. See page [2-48](#) for additional calibration settings. This mode requires additional hardware.
 - **FM+HD:** also known as hybrid/simulcast or low-level combined, this mode transmits the analog carrier (FM modulated) and the upper and lower digital sidebands of OFDM IBOC carriers. See page [2-48](#) for additional calibration settings. This mode requires additional hardware.
 - **DRM+:** transmits a DRM OFDM signal using the I/Q stream from a DRM modulator connected to the desired AES input. See page [2-48](#) for additional calibration settings. This mode requires additional hardware.



Note:

Settings on the Presets tabs are shown/hidden based on the chosen settings. Not all settings are available in all modes.

MODE - ADDITIONAL CALIBRATION SETTINGS:

- **IBOC Injection (Lower):** for FM+HD and HD modes, enter value, in dB, between -20 and -10 dB for the IBOC injection level of the lower sideband of digital carriers. This value determines the relationship between the digital carriers power and the analog carrier power. Example: -20 dB indicates that the total RMS power of the digital carriers will be 1/100 of the total RMS power of the analog carrier. -10 dB indicates that the total RMS power of the digital carriers will be 1/10 of the total RMS power of the analog carrier.
- **IBOC Injection (Upper):** for FM+HD and HD modes, enter value, in dB, between -20 and -10 dB for the IBOC injection level of the lower sideband of digital carriers. This value determines the relationship between the digital carriers power and the analog carrier power. Example: -20 dB indicates that the total RMS power of the digital carriers will be 1/100 of the total RMS power of the analog carrier. -10 dB indicates that the total RMS power of the digital carriers will be 1/10 of the total RMS power of the analog carrier.

Note:

The actual digital sideband power is 3dB less than that indicated in the upper or lower IBOC Injection fields; i.e. if -20dBc is entered in the upper and lower IBOC Injection fields, the upper and lower digital sideband power levels are actually -23dBc; this way, when added, the resultant total digital power level is -20dBc.

For symmetrical sideband transmission: if -14dBc IBOC Injection level is desired (total digital power of upper + lower sidebands is 4% of analog carrier power), set the upper and lower IBOC Injection levels to -14dBc.

For asymmetrical sideband transmission, account for the fact that the actual sideband power level is 3dB less than that shown. For example, if the upper digital sideband IBOC Injection level is entered as -14dBc, the actual power level will be -17dBc. This is equally true for the lower digital sideband.

- **HD PA Volts:** for FM+HD, HD and DRM+ modes, enter value, in volts, between 25.0 V and 53.0 V. This value sets the drain voltage applied to the PAs in the RF power modules, from their associated power supplies. This value affects IBOC/DRM+ performance. Larger values result in an improved spectrum, but decreased efficiency. Conversely, smaller values result in improved efficiency, but degrade the spectrum. Typical values are between 35 V and 50 V, and depend on many variables such as power level, frequency and injection level.

**Note:**

For additional information on operating FM+HD, HD and DRM+ presets, please refer to Improving Transmitter Performance for IBOC Presets in Section 4 of this manual.

- **HD IPA Volts:** for FM+HD, HD and DRM+, enter value, in volts, between 25.0 V and 53.0 V. This value sets the drain voltage applied to the IPA in the RF power modules, from their associated power supplies. This value affects IBOC/DRM+ performance. Larger values result in an improved spectrum, but decreased efficiency. Conversely, smaller values result in improved efficiency, but degrade the spectrum. The default value is 50 V and typically does not change.
- **HD Power Boost:** for FM+HD mode only. Enable this setting to engage Nautel's digital PowerBoost process, an advanced peak-to-average power ratio reduction that increases hybrid-mode transmitter efficiency and power capability. HD PowerBoost is only available in transmitters with the appropriate exciter configuration.

Figure 2.36: Presets - Main Audio

Main Audio - (see [Figure 2.36](#)):

- **Audio Source** Connects the appropriate exciter input for use. Available options are:
 - **Left/Right/Mono:** this source allows for further configuration via **Analog Level**, **Audio Mode (Mono L+R, Mono L, Mono R, Stereo)**, **15kHz Lowpass**, **Preemphasis**, **Main Audio Gain Adjust** settings. See page [2-51](#) for additional configuration information.
 - **MPX:** this source allows for further configuration via the **MPX Level** setting. See page [2-51](#) for additional configuration information.
 - **Primary Digital:** this source allows for further configuration via **Digital Level**, **Audio Mode (Mono L+R, Mono L, Mono R, Stereo)**, **15kHz Lowpass**, **Preemphasis**, **Main Audio Gain Adjust** settings. See page [2-51](#) for additional configuration information.
 - **Secondary Digital:** this source allows for further configuration via **Digital Level**, **Audio Mode (Mono L+R, Mono L, Mono R, Stereo)**, **15kHz Lowpass**, **Preemphasis**, **Main Audio Gain Adjust** settings. See page [2-51](#) for additional configuration information.
 - **MPX Over AES:** this source allows for further configuration via the **Digital Level** setting. See page [2-51](#) for additional configuration information.

MAIN AUDIO - ADDITIONAL CONFIGURATION SETTINGS:

- **Analog Level:** applies to **Left/Right/Mono** source only; enter value between -12 and +12 dBu, which represents the input voltage level that yields 100% modulation (typically 4.7 dBu).
- **Digital Level:** applies to **Primary Digital, Secondary Digital** and **MPX Over AES** sources only; enter value between -25.5 and 0 dBFS, with a typical setting of -4 dBFS (100% modulation value).
- **Audio Mode:** select **Mono L, Mono R, Mono L+R** or **Stereo** (applies to **Left/Right/Mono, Primary Digital** or **Secondary Digital** sources; selecting **Stereo** applies a 19 kHz pilot).
- **15kHz Lowpass Filter:** applies to **Left/Right/Mono, Primary Digital,** and **Secondary Digital** audio modes; select **On** (applies 15 kHz low-pass filter to audio input) or **Off**.
- **Preemphasis:** select 0 us, 25 us, 50 us or 75 us. This setting applies to all sources except **MPX**.
- **Main Audio Gain Adjust:** applies to **Left/Right/Mono** source only; allowable range is -20 to 10 dB. This configuration setting will increase the incoming signal level and yield a proportional increase in % modulation.
- **MPX Level:** applies to **MPX** source only. Set this parameter level in Vpp (typically 3.5 Vpp - 100% modulation value). The allowable range for this setting is between 1-5 Vpp.

Figure 2.37: Presets - SCA

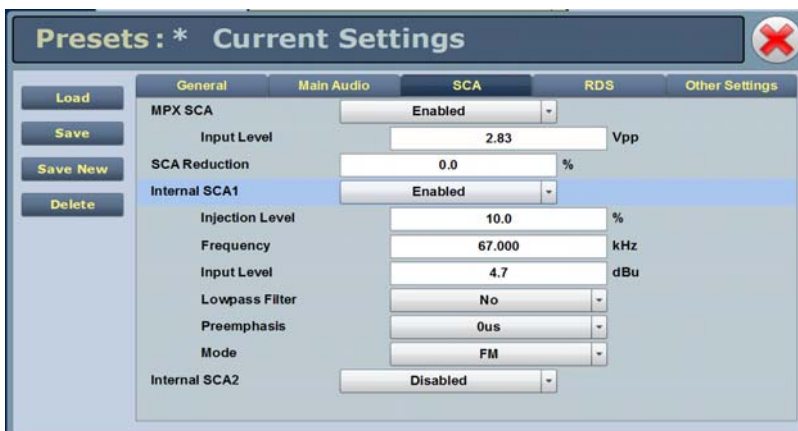

SCA - (see [Figure 2.37](#)):

- **MPX SCA** Connector (J7:A for SCA1, J7:B for SCA2) for use with an externally generated SCA; select **Enabled** or **Disabled**. When enabled, all the selections listed below are active.
 - **Input Level:** signal level that represents 10% modulation. Enter a value between 1 and 5 V p-p (typically 2.83 Vpp).
- **SCA Reduction** Attenuation applied to the SCA input; set between 0 and 20% (used to reduce the modulation level of the main audio when SCAs are enabled; typically, for every 2% of SCA modulation, the main audio modulation must be reduced by 1%).
- **Internal SCA1/2** Enable or disable the appropriate internal SCA (**SCA1** or **SCA2**). When enabled, the settings listed below are active for the associated SCA signal (1 or 2).
 - **SCA1 or SCA2 Injection Level:** enter value between 0 and 20% (typically 10%); this level is added to the composite baseband signal.
 - **SCA1 or SCA2 Frequency:** enter value between 20 and 100 kHz (typically set to 67 kHz or 92 kHz).
 - **SCA1 or SCA 2 Input Level:** enter value between -12 and +12 dBu, which represents the input voltage level that yields 10% modulation (typically 4.7 dBu).

- SCA1 or SCA2 Lowpass Filter: select **Enabled** (applies 7.5 kHz low-pass filter to audio input) or **Disabled**.
- SCA1 or SCA2 Preemphasis: select 0 us, 50 us, 75 us or 150 us.
- SCA1 or SCA2 Mode: select **FM** (frequency modulated sub-carrier, typical) or **DSB-SC** (double side band suppressed carrier).

Figure 2.38: Presets - RDS

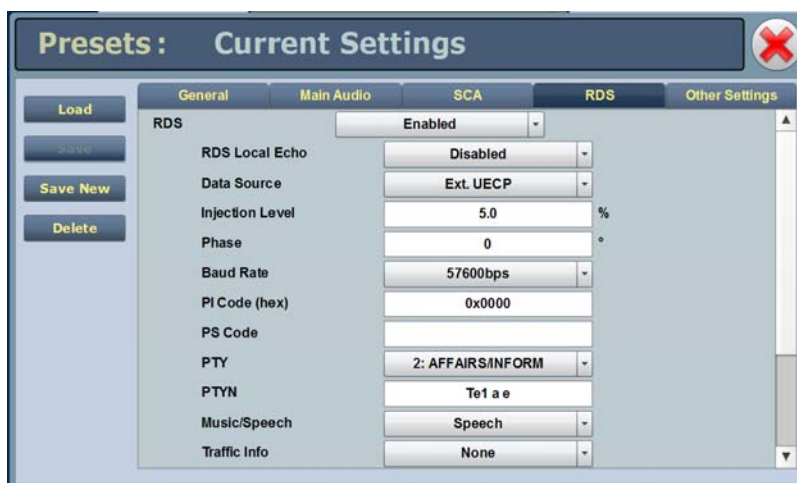

Note:
 Refer to FCC guidelines for allowable modulation depth with SCAs or RDS enabled.

RDS - (see [Figure 2.38](#)):

- RDS When **Enabled**, all the selections listed below are active.
 - **RDS Local Echo:** select **Enabled** or **Disabled**. When **Enabled**, the exciter RDS port transceiver will echo all inputs and controls received back to the terminal.

- **Data Source:** select Ext. UECP, Internal RBDS, Internal RDS or Ext. ASCII, ASCII Over IP, UECP Over IP.
- **Injection Level:** enter value between 0 and 10% (typically 5%). This level is added to the composite baseband signal.
- **Phase:** enter value in degrees.
- **Baud Rate:** select 75, 150, 300, 600, 1200, 2400, 4800, 9600, 19200, 38400 or 57600 bps. This selection does not apply to internal data sources.
- **PI Code (hex):** (programme identification code) this unique code is used to identify a broadcast station. Every station gets assigned a specific code with a country identifying prefix. In the USA this code is determined by applying a formula to the station's call sign. Additional information can be found at www.nrsstandards.org. This selection applies to internal data sources only.
- **PS Code:** (programme service code) this is simply an eight-character static display that represents the call letters or station identity name. Most RDS capable receivers display this information and, if the station is stored in the receiver's presets, will cache this information with the frequency and other details associated with that preset. This selection applies to internal data sources only.
- **PTY:** this coding of up to 31 pre-defined programme types allows users to find similar programming by genre. This selection applies to internal data sources only.
- **PTYN:** (programme type name) this field can be used for detailed description of the **PTY** by 8 digits. Example: if the **PTY** is 4 (Sport) a **PTYN** like "Cycling" could be transmitted. The **PTYN** is intended for displaying additional information only and cannot be used for automatic station tuning like the **PTY**. The **PTYN** is optional and not obligatory. This selection applies to internal data sources only.
- **Music/Speech:** select **Music** or **Speech**. This selection applies to internal data sources only.

- **Traffic Info:** select **None**, **TA** (Traffic Announcement) , **TP** (Traffic Programme) or **TA+TP**. The receiver can often be set to pay special attention to this flag and, for example, stop the tape/pause the CD or retune to receive a traffic bulletin. The **TP** flag is used to allow the user to find only those stations that regularly broadcast traffic bulletins whereas the **TA** flag is used to signal an actual traffic bulletin in progress. This selection applies to internal data sources only.
- **Alternate Frequencies:** select **None** or **1** through **6**. This allows a receiver to re-tune to a different frequency providing the same station information when the first signal becomes too weak. This is often utilized in car stereo systems. This selection applies to internal data sources only.
- **Artificial Head:** select **Yes** or **No**. This selection is a decoder identification operating mode flag.
- **Compression Flag:** select **Yes** or **No**. This selection is a decoder identification operating mode flag.
- **Dynamic:** select **Yes** or **No**. This selection is a decoder identification operating mode flag.
- **Stereo:** select **Yes** or **No**. This selection is a decoder identification operating mode flag.



Note:

Refer to FCC guidelines for allowable modulation depth with SCAs or RDS enabled.

Figure 2.39: Presets - Other Settings

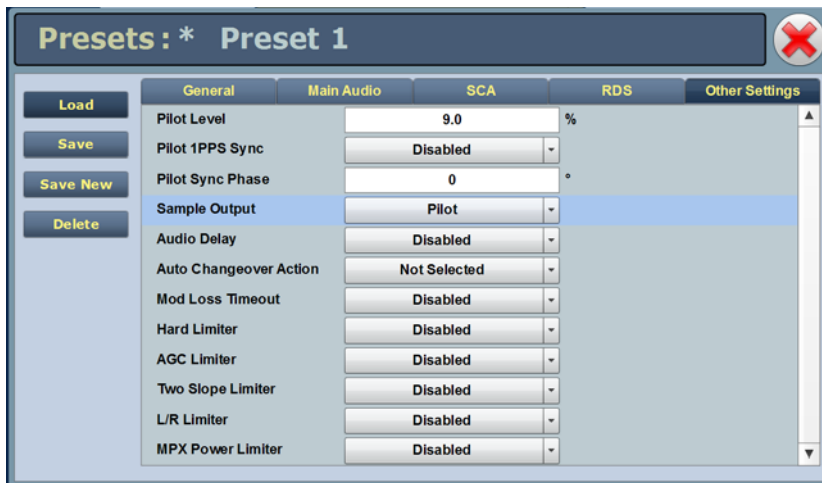

Other Settings - (see [Figure 2.39](#)):

- **Other Settings** Provides the following sub-functionality:
 - **Pilot Level:** enter value between 6 and 12 % (typically 9 %). This level is added to the composite baseband signal.
 - **Pilot 1 PPS Sync:** select **Enabled**.
 - **Pilot Sync Phase:** if **Pilot 1 PPS Sync** is enabled, enter value between 0 and 360 degrees (typically 0 degrees).
 - **Sample Output:** determines which sample signal will be present on exciter's rear panel **PILOT/MPX SAMPLE OUT BNC connector**. Select **Pilot** (default setting, pilot sample present) or **MPX** (Composite) (composite baseband signal present).
 - **Audio Delay:** select **Enabled**, then enter value in the allowable range of 0-12000 ms. Default is 0. **Audio Delay** is used to time align the receiver output of decoded analog and digital audio signals.

- **Auto Changeover Action:** users can select which preset they want the transmitter to switch to in the event of an automatic exciter changeover. This function is ideal for changing to a preset that has a different HD PA Volts value, which is required when a different exciter is active - e.g. HD Power Boost active exciter A requires less HD PA Volts to comply with spectral mask, thus improving dissipation. However if an automatic changeover to non-HD Power Boost enabled exciter B occurs, the **Auto Changeover Action** preset will have a higher HD PA Volts value (less efficient, but required in order to comply with spectral limits).
- **Mod Loss Timeout:** select **Enable** if so required. If **Enable** is selected the following sub-fields will appear:
 - **Action:** select the action to take on the loss of a modulating signal post the timeout period. Select **None** (no resulting action), **Inhibit** (inhibits the RF output and fans until the audio returns) or **Change Preset** (changes the active preset).
 - **Mod Loss Preset:** displayed only if **Action** is set to **Change Preset**. Select the preset from the drop down list that will activate upon the loss of a modulating signal, post the timeout period.
 - **Timeout Minutes:** sets the delay, in minutes, between modulation loss detection and the resulting action. Enter a value in the allowable range of 0 and 255 minutes.
 - **Timeout Seconds:** sets the delay, in seconds, between modulation loss detection and the resulting action. Enter a value in the allowable range of 0 and 59.9 seconds.
 - **Threshold:** sets the threshold for modulation loss detection. Enter a value in the allowable range of 0 and 100%.
- **Hard Limiter:** select **Enabled**, then enter the hard limit threshold percentage (allowable range is 0-160%, defaulted to 140%). If enabled, the modulation level will be limited (audio signal clipped or distorted) if it exceeds the hard limit threshold.

-
- **AGC Limiter:** select **Enabled**, then enter **AGC Limit** percentage (allowable range is 0-160%, defaulted to 120%) and **Time Constant** (allowable range is 0-1000 ms, defaulted to 0 ms). If **Enabled**, when the modulation level exceeds the AGC Limit, the gain of the audio input will instantly decrease in order to reduce the modulation level below the AGC limit threshold. Recovery from this audio gain reduction is dependent on the **Time Constant** delay (fast attack, slow recovery). The input signal is briefly distorted by the audio gain reduction when the threshold is exceeded.

 - **Two Slope Limiter:** if **Enabled**, when the modulation level exceeds the **Threshold**, the gain of the audio input will instantly change according to the gain percentage setting (percentage of the initial gain, that which is below the threshold). The input signal is distorted by the audio gain change.
 - **Threshold** (allowable range is 0-160%, defaulted to 120%).
 - **Gain** (allowable range is 0-100%, defaulted to 56.2%).

 - **L/R Limiter:** this look-ahead limiter can be applied to the signal immediately before the stereo generator in the exciter. It has a fixed attack time (and corresponding delay) of approximately 1 ms. It can be configured to reduce the signal, if the gain setting is 0 dB or less, or can be used to perform an AGC function and boost quiet sections of the audio if a positive gain setting is used. If **Enabled**, enter the following parameters:
 - **Max Gain** (allowable range is -20 to 20 dB, defaulted to 0 dB).
 - **Decay Time** (allowable range is 0 to 60 s, defaulted to 0 s).
 - **Hold Time** (allowable range is 0 to 60 s, defaulted to 0 s).

 - **MPX Power Limiter:** if **Enabled**, enter **MPX RMS Limit** . This limit allows the broadcast signal to remain in compliance with the MPX power limits as suggested in ITU-R BS.412-9. While the limiter will keep the transmitter in compliance, it is recommended that adjustment to the processing be made in such a way as to minimize the reductions performed by the limiter. Otherwise, the signal will not take advantage of the peak modulation capability available.
 - **MPX RMS Limit** (allowable range is -12 to 12 dB_r, defaulted to 0 s).
-

VIEWING TRANSMITTER STATUS

You can view the NV30/NV40’s operational status using the [Transmitter Status page](#) - see [Figure 2.40](#). This page shows current active alarms and status to aid in fault diagnosis. To view the [Transmitter Status page](#), select **Status** from the AUI bottom banner.

This section includes the following topics:

- [Viewing alarm details on page 2-60](#)
- [Status button colour indications on page 2-60](#)
- [Resetting alarms on page 2-60](#)

Figure 2.40: Transmitter Status page

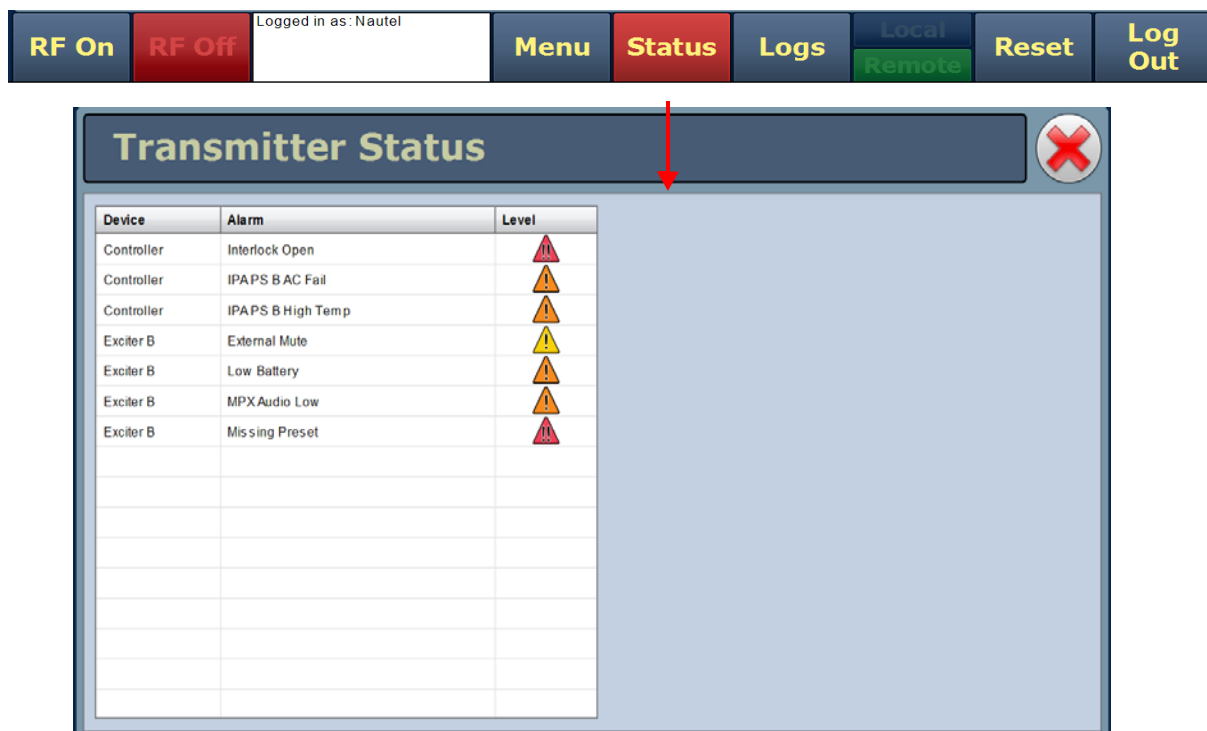

VIEWING ALARM DETAILS

The [Transmitter Status page](#) - see [Figure 2.40](#) on [page 2-59](#) displays a table that lists the active alarm details under the following columns:

- **Device** - identifies the alarms by their originating device (e.g., Controller, Exciter A, etc.)
- **Alarm** - identifies the type of alarm (alarm name).
- **Level** - identifies the severity level of the alarm.



= low (RF output not affected)



= medium (RF output may be reduced)



= high (RF output may be inhibited)

Note:
 When viewing alarms, cross reference the alarm name, (which appears in the Alarm column of the Transmitter Status page) with Table 1.1 of the Troubleshooting Manual.

STATUS BUTTON COLOUR INDICATIONS

- When the **Status** button is red, one or more active alarms are indicating that the transmitter may be in an ‘off-air’ state.
- When the **Status** button is amber, one or more active alarms are indicating that the transmitter is still ‘on-air’, but may be at reduced power.
- When the **Status** button is green, no alarms are being reported and the transmitter is operating normally.

RESETTING ALARMS

When an alarm is present, use the **Reset** button, at the bottom of any AUI screen, (see [Figure 2.41](#)) to clear any latching alarms that are holding the transmitter in an “off-air” state. If the offending alarm has cleared, then the transmitter should resume operation.

Figure 2.41: Reset Button



FACTORY SETTINGS

Values for critical parameters are set using the **Factory Settings** page (see [Figure 2.42](#)), which is accessed from the **Menu** page. To use this page, simply select an item from the list on the left-side of the page to open related information on the right-side of the page.



WARNING: DEVICE SETTINGS ARE ESTABLISHED AT THE FACTORY AND SHOULD NOT REQUIRE ANY ADJUSTMENT. THESE SETTINGS AFFECT CRITICAL SYSTEM PROTECTION CIRCUITS. MAKING CHANGES TO THESE SETTINGS MAY VOID YOUR WARRANTY. CONTACT NAUTEL BEFORE MAKING CHANGES.

This section includes the following topics:

- [System configuration on page 2-62](#)
- [Transmitter type on page 2-63](#)
- [Scaling on page 2-64](#)
- [Thresholds on page 2-65](#)
- [Redundant supplies on page 2-66](#)
- [IPA bias balance on page 2-67](#)
- [PA field bias on page 2-69](#)

Figure 2.42: Factory Settings

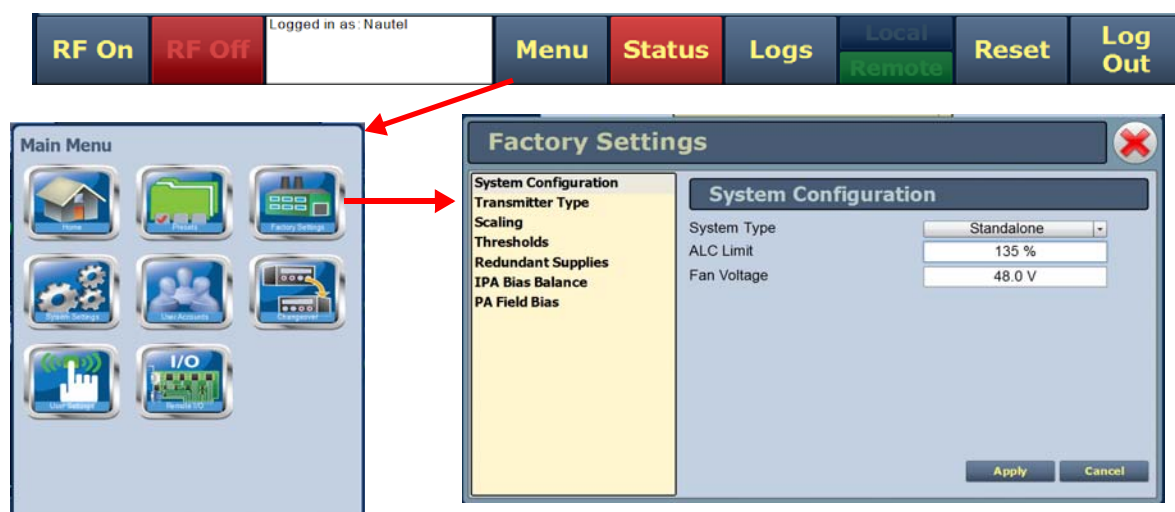

SYSTEM CONFIGURATION

This factory setting (see [Figure 2.43](#)) configures the type of system the transmitter will be part of, sets the ALC Limit (in %), and sets the cooling Fan Voltage.

- System Type
 - Standalone: indicates the transmitter operates by itself.
 - SC1 Combined: indicates the transmitter operates as part of a combined system and is controlled by the SC1 system controller.
 - N+1: Indicates the transmitter operates as part of a main/standby or +1 backup for N other transmitters, and is under the control of the SC1 system controller.
- ALC Limit Allowable range is 0-135%, with a typical value of 100%. ALC limit allows the transmitter to compensate for any power shortfall by setting DAC limit at a higher percentage than should be required.
- Fan Voltage Allowable range is 30-53V, with a the typical value of 48V.

Figure 2.43: Factory Settings - System Configuration

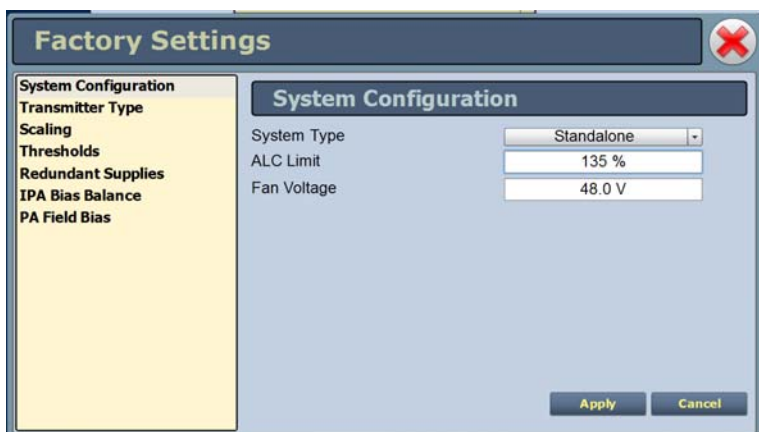

WARNING: DEVICE SETTINGS ARE ESTABLISHED AT THE FACTORY AND SHOULD NOT REQUIRE ANY ADJUSTMENT. THESE SETTINGS AFFECT CRITICAL SYSTEM PROTECTION CIRCUITS. MAKING CHANGES TO THESE SETTINGS MAY VOID YOUR WARRANTY. CONTACT NAUTEL BEFORE MAKING CHANGES.

TRANSMITTER TYPE

This factory setting parameter (see [Figure 2.44](#)) allows for setting the transmitter type (NV5, NV10, NV20 etc.). This setting is one-time, factory configured and cannot be changed.

Figure 2.44: Factory Settings - Transmitter Type

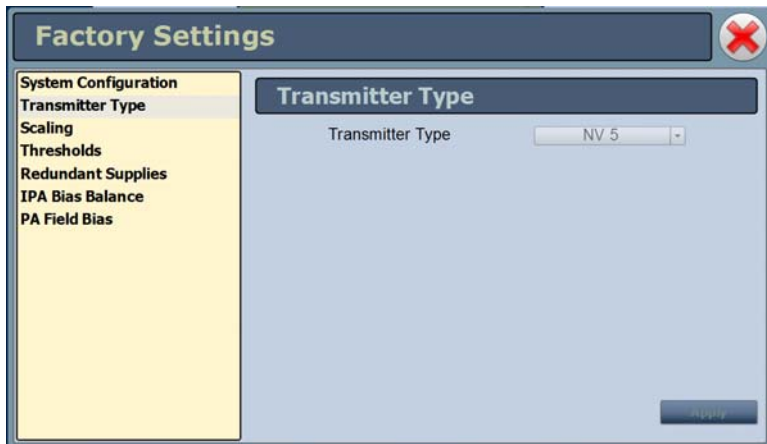

WARNING: DEVICE SETTINGS ARE ESTABLISHED AT THE FACTORY AND SHOULD NOT REQUIRE ANY ADJUSTMENT. THESE SETTINGS AFFECT CRITICAL SYSTEM PROTECTION CIRCUITS. MAKING CHANGES TO THESE SETTINGS MAY VOID YOUR WARRANTY. CONTACT NAUTEL BEFORE MAKING CHANGES.

SCALING

This factory setting (see [Figure 2.45](#)) supports the calibration of various metered parameters.

Figure 2.45: Factory Settings - Scaling

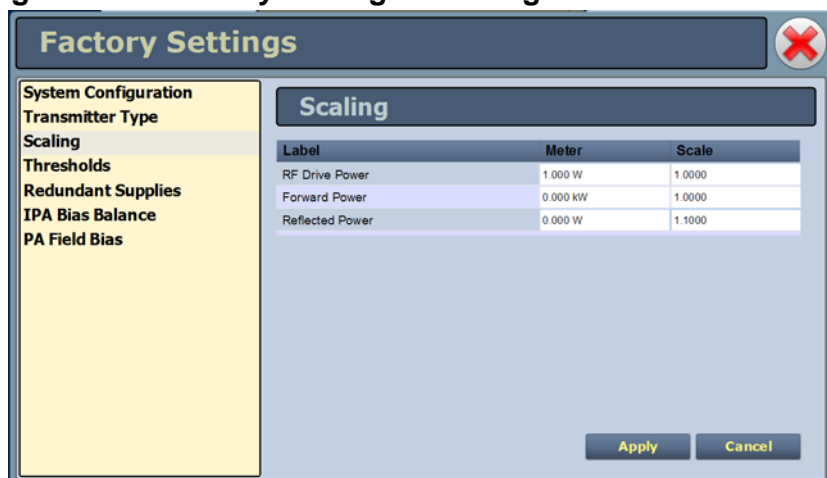

WARNING: DEVICE SETTINGS ARE ESTABLISHED AT THE FACTORY AND SHOULD NOT REQUIRE ANY ADJUSTMENT. THESE SETTINGS AFFECT CRITICAL SYSTEM PROTECTION CIRCUITS. MAKING CHANGES TO THESE SETTINGS MAY VOID YOUR WARRANTY. CONTACT NAUTEL BEFORE MAKING CHANGES.



Note:

FM and FM+HD modes display analog transmitter power output in the top banner of the AUI. HD and DRM+ modes display total digital RMS power. For FM+HD if the total RMS power is desired, see applicable meters in controller device list. See [Identifying meter information on a specific sub-device on page 2-42](#).

THRESHOLDS

This factory setting (see [Figure 2.46](#) and [Figure 2.47](#)) supports the setting of alarm thresholds for critical parameters. Select the desired threshold from the list located in either the **Transmitter** or **RF Module** tabs and touch the applicable field to enable editing. The current threshold is displayed. Enter the new threshold and press **Apply** to save changes.

Figure 2.46: Factory Settings - Thresholds (Transmitter) - Default Values Shown



Figure 2.47: Factory Settings - Thresholds (RF Modules)- Default Values Shown



WARNING: DEVICE SETTINGS ARE ESTABLISHED AT THE FACTORY AND SHOULD NOT REQUIRE ANY ADJUSTMENT. THESE SETTINGS AFFECT CRITICAL SYSTEM PROTECTION CIRCUITS. MAKING CHANGES TO THESE SETTINGS MAY VOID YOUR WARRANTY. CONTACT NAUTEL BEFORE MAKING CHANGES.

REDUNDANT SUPPLIES

This factory setting (see [Figure 2.48](#)) supports configuring redundant fan, IPA, LVPS and 12 V power supplies. Select **Yes** (default) if the supply operates as a redundant set. Select **No** if the supply is standalone.

Figure 2.48: Factory Settings - Redundant Supplies



WARNING: DEVICE SETTINGS ARE ESTABLISHED AT THE FACTORY AND SHOULD NOT REQUIRE ANY ADJUSTMENT. THESE SETTINGS AFFECT CRITICAL SYSTEM PROTECTION CIRCUITS. MAKING CHANGES TO THESE SETTINGS MAY VOID YOUR WARRANTY. CONTACT NAUTEL BEFORE MAKING CHANGES.

IPA BIAS BALANCE

IPA Bias Balance (see [Figure 2.49 on page 2-68](#)) allows for optimal balancing of RF power module outputs to minimize reject load power. An **IPA Balancing Recommended Alarm** will be generated when balancing is suggested. This may occur after an RF power module has been replaced or repaired. While RF is enabled (on) and the transmitter is operating at the desired power level in the desired preset, press the **Start** button to initiate the process. When the process has been completed, the **Save** and **Cancel** buttons will activate to either save the result to the active preset or abort the function without affecting the previous balance. Note that the user may press **Stop** while a balancing is in process but still save or cancel the interim result.

The balancing progress may be observed by monitoring the **Reject Power Percentage** meter. Balancing targets a reject power percentage of 0.75% or less of the transmitter's maximum power capability. (An IPA Balancing Recommended alarm will be generated if this percentage exceeds 1.5%.)

While this routine can be performed when operating in most presets (as the DAC bias numbers are stored in the controller's EEPROM), it should also be noted that this balancing process affects only the active preset.



Note:

IPA bias balancing cannot be performed when the transmitter is in the Current Settings preset. Users must have an active preset saved (without edits) in order for the updated IPA bias data to be stored properly. IPA bias balancing can also not be performed if there is a module fault present (e.g. PA fail).

Users may also adjust the bias values individually to either a user specified value or to the default value saved in that module's EEPROM (see [Factory Settings - PA Field Bias on page 2-69](#)). Note, that if an auto-balance is started any user set values will be replaced with default values before the process starts. Therefore, manual adjustment should be undertaken only after an auto-balancing has been completed or manually stopped.

Figure 2.49: Factory Settings - IPA Bias Balance

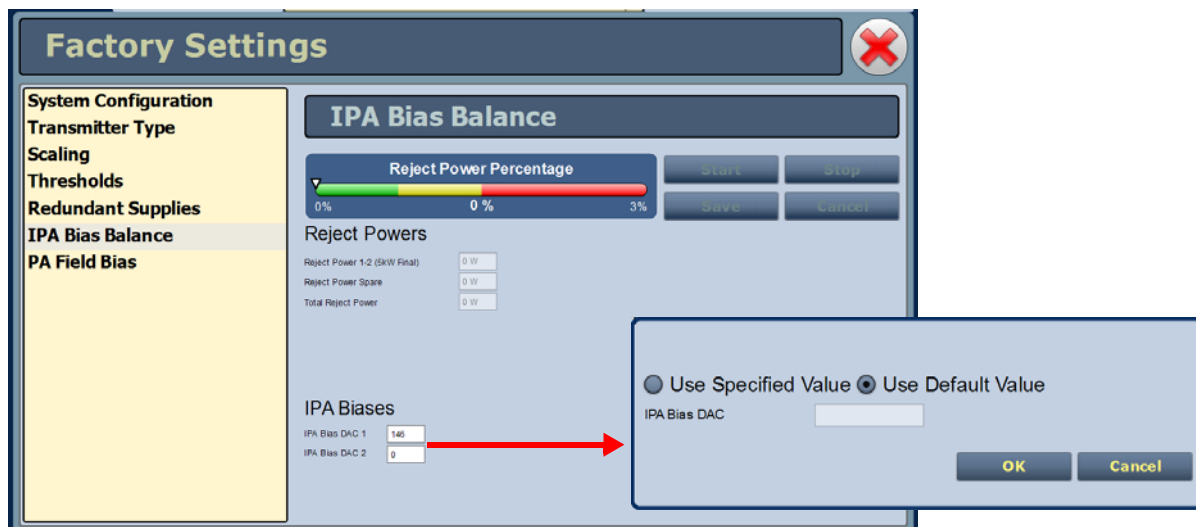

IPA Bias DAC 1 = Module 1
 IPA Bias DAC 2 = Module 2

Note:
 The IPA Bias Balance function targets the lowest possible total transmitter reject power. However, there is no guarantee that it will achieve less than a specific amount. Variables such as RF module output power and phase differences result in system reject power that can sometimes not be compensated for with this function.

Note:
 The Reject Power Percentage meter is only available in this functional menu. The green/amber/red colours are simply to provide user feedback as to the progress of the function. If the transmitter is operating normally, without fault, and the total reject power percentage falls within the amber or red "post" an IPA bias balance routine, there is nothing to be concerned with, the function is simply not able to completely compensate for the reject power (phase/amplitude differences).

PA FIELD BIAS

This factory setting (see [Figure 2.50](#)) allows the user to easily set the applicable bias values from the control tag provided with the replacement PA.

Select which RF Module and PA position the replacement PA was installed in, then enter the **Bias Values** for indices 1 through 5 from the factory supplied control tag.

The **Bias Values** fields accept only a decimal number format. Enter the decimal number from the control tag, or if your spare PA control tag specifies a hexadecimal number, convert it to decimal and then enter the appropriate decimal number.

Figure 2.50: Factory Settings - PA Field Bias

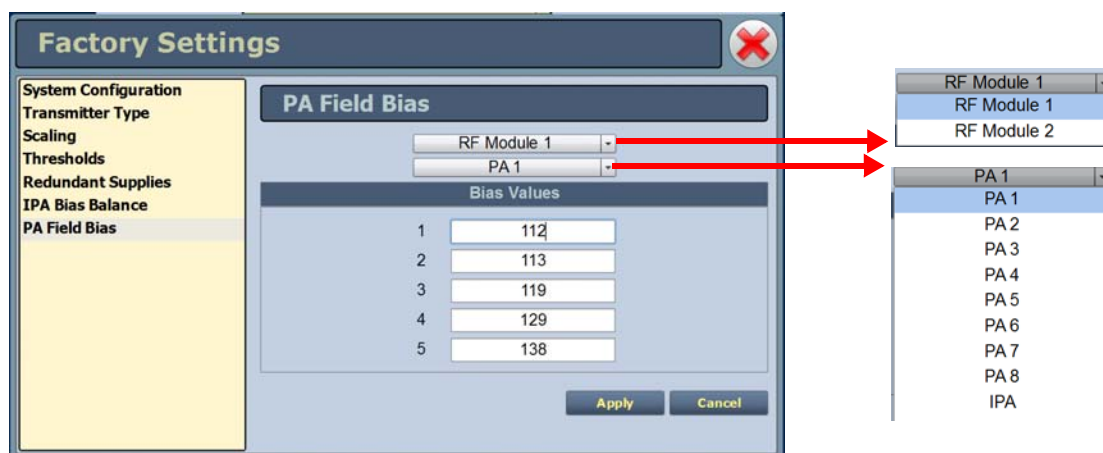



WARNING: DEVICE SETTINGS ARE ESTABLISHED AT THE FACTORY AND SHOULD NOT REQUIRE ANY ADJUSTMENT. THESE SETTINGS AFFECT CRITICAL SYSTEM PROTECTION CIRCUITS. MAKING CHANGES TO THESE SETTINGS MAY VOID YOUR WARRANTY. CONTACT NAUTEL BEFORE MAKING CHANGES.

SYSTEM SETTINGS

Users determine critical system configuration parameters via the **System Settings** page (see [Figure 2.51](#)), which you access from the **Menu** page.

This section includes the following topics:

- [Reset on page 2-71](#)
- [Upgrade software on page 2-72](#)
- [Exciter TCXO on page 2-73](#)
- [IBOC settings on page 2-73](#)
- [Audio input calibration on page 2-75](#)
- [Turn-on delay on page 2-76](#)
- [Defaults on page 2-76](#)
- [FM polarity on page 2-78](#)

Figure 2.51: System Settings Page

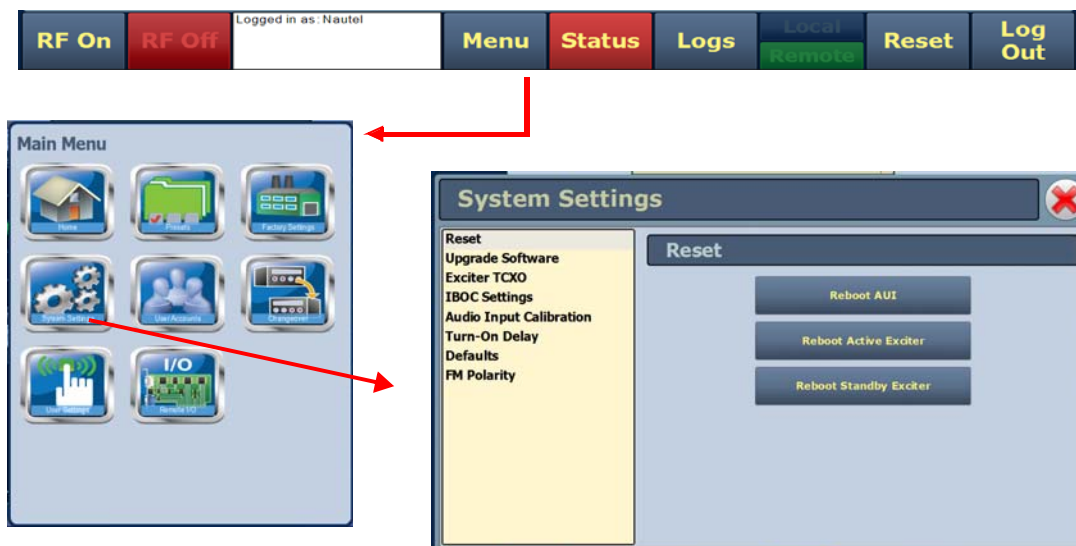

RESET

The **Reset** page (see [Figure 2.52](#)) allows users to reboot three items - the AUI, the active exciter and the standby exciter (if installed).

Figure 2.52: System Settings - Reset

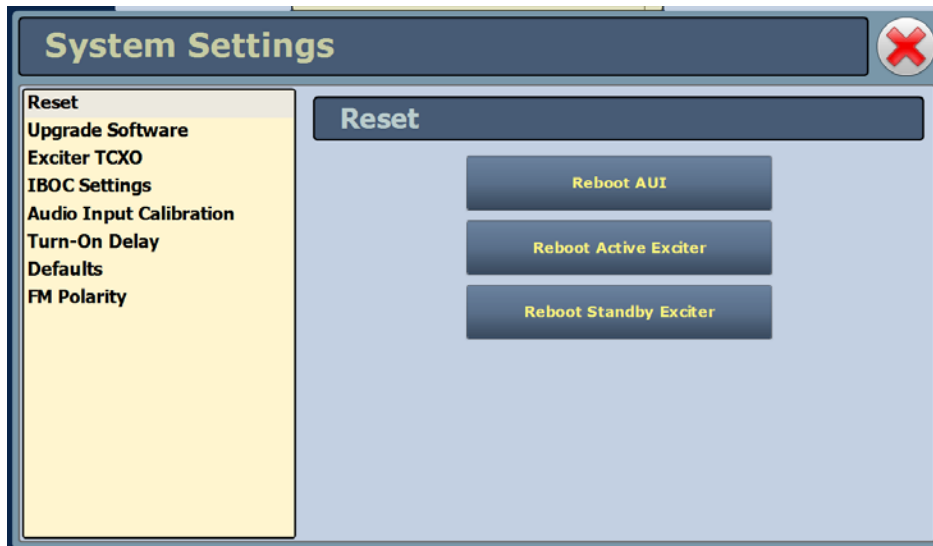

Procedure to reset the AUI or either Exciter:

1. Select the **Reset** option from the left-side of the **System Settings** page to open a related window on the right-side of the page.
2. Reset the items by pressing the appropriate key.
 - To reset the AUI (advanced user interface), press **Reboot AUI**.
 - To reset the active exciter press **Reboot Active Exciter**
 - To reset the standby exciter press **Reboot Standby Exciter**.

After rebooting the AUI, users will need to log back into the transmitter AUI once again (see [Logging into the AUI on page 2-3](#)). If the active exciter is rebooted, the transmitter's RF power will be interrupted if in **RF On** mode but the AUI will not be reset. If the standby exciter is rebooted, the transmitter's RF power will not be interrupted if in **RF On** mode, nor will the AUI be reset.

UPGRADE SOFTWARE

The **Upgrade Software** page allows for uploading a suite of software upgrade files (.tgz files) via remote connection. Navigate the page as described below. Please note that users cannot add upgrade files via the local AUI touchscreen. For additional information on loading software, see [Upgrading software on page 4-1](#) of this manual.

Figure 2.53: System Settings - Upgrade Software (Remote Upgrade Shown)

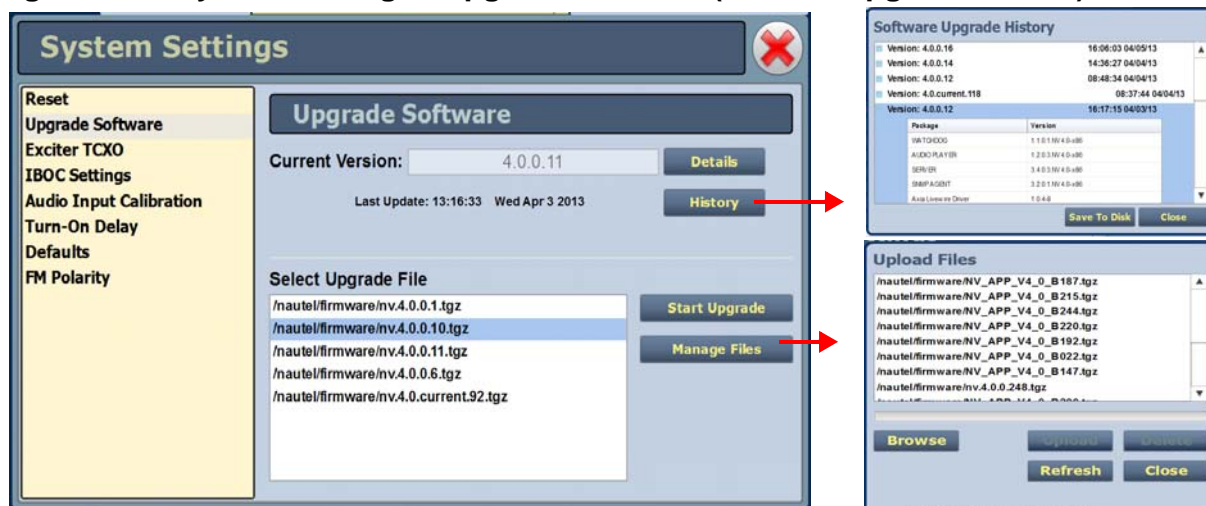

Select the **Upgrade Software** option from the left-side of the **System Settings** page to open a related window on the right-side of the page. The page consists of the following sections and buttons:

- **Current Version** - indicates the current software version.
- **Select Upgrade File** - displays the available upgrade files uploaded to the transmitter.
- **Details** - opens a window containing information about the installed software. If an upgrade file is selected, the screen will show a comparison between the installed version and the selected upgrade by component. Identical versions are shown in green; different versions are shown in red. You can also view the details of the previous upgrade by pressing the **View Last Upgrade** checkbox.
- **History** - displays a window containing a history of the upgrades to the software. Press the + button to maximize the details of the software. You can save this information to disk as a .txt file from the remote AUI.
- **Start Upgrade** - begins the process of upgrading the current software with the selected upgrade file.
- **Manage Files** (available through the remote AUI only) - opens a window displaying the files you can upload to upgrade the software. You can add or delete files from this list using the **Browse**, **Upload** and **Delete** buttons in the window.

EXCITER TCXO

This system setting allows users to calibrate the internal clock to a user supplied external high precision 10MHz clock reference (e.g. GPS synchronized 10MHz clock). Once this external 10MHz clock reference is connected, the **10MHz Int-Ext Offset** field will display the difference between the internal and external frequencies (in ppm). Users can press the **Start** button to automatically calibrate the internal TCXO to the external reference source; equally, they can manually enter the measured internal-external offset value into the **TCXO Offset Value** field and press **Apply**.

If no external high precision 10MHz clock reference is connected, but the actual transmitter carrier frequency is being measured with a calibrated external frequency counter, operators can manually offset the internal TCXO by entering the appropriate ppm difference in the **TCXO Offset Value** field. For example, if the frequency of the transmitter is 1 ppm too high, then a positive 1 ppm should be entered in the **TCXO Offset Value** field in order to compensate. Similarly, if the transmitter frequency is too low, enter a negative ppm value. After an adjustment is made, press **Apply**.

For dual exciters, two tabs appear (Exciter A and Exciter B) to allow calibration of each exciter.

Figure 2.54: System Settings - Exciter TCXO

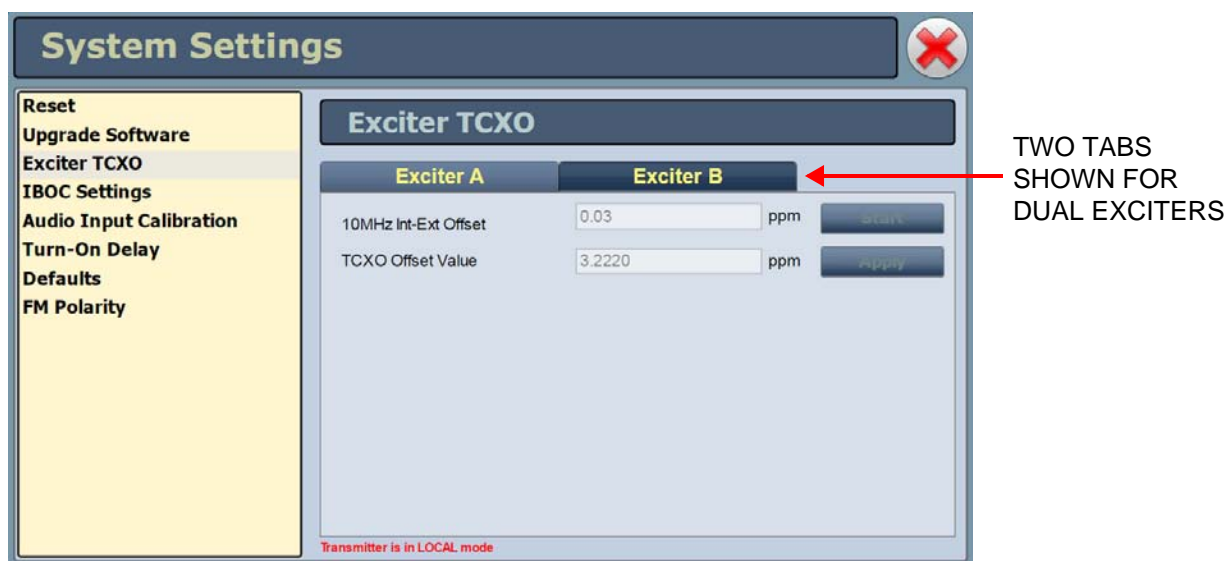

IBOC SETTINGS

This system setting (see [Figure 2.55 on page 2-74](#)) allows users to establish Forward Tap Delay, FM+HD Low Inj Gain, FM+HD High Inj Gain and HD only system Gain levels. It also allows for an IBOC power calibration. Changes apply to the active exciter (A or B) only. To calibrate the other exciter, switch to the other exciter and repeat the change.

- **Forward Tap Delay** - This field displays the time delay (in unit taps) between the forward path signal from the exciter and the reverse path signal into the exciter, fed back from the output of the transmitter. This value is factory adjusted (to synchronize the phase of the forward and reverse signals so that pre-correction can operate properly) and should not require any adjustment in the field.
- **Auto-Find Gain** - Press the Start button to automatically find the optimized gain while the transmitter is RF On and in the applicable preset mode/injection level.
- **FM+HD Low Inj Gain** - Applicable for FM+HD mode only (at -20dBc to -15.1dBc injection levels) and represents the starting/default gain applied to the forward path signal within the exciter at initial turn on/ramp-up.
- **FM+HD High Inj Gain** - Applicable for FM+HD mode only (at -15dBc to -10dBc injection level) and represents the starting/default gain applied to the forward path signal within the exciter at initial turn on/ramp-up.
- **HD Gain** - Applicable for HD mode only and represents the starting/default gain applied to the forward path signal within the exciter at initial turn on/ramp-up.
- **IBOC Power Calibration** - This calibration occurs at the factory and should not require any adjustment in the field. This calibration is performed in FM mode.
- **Calibration Value** - This field displays the calibration of the exciter's measurement of the transmitter power.

Figure 2.55: System Settings - IBOC Settings

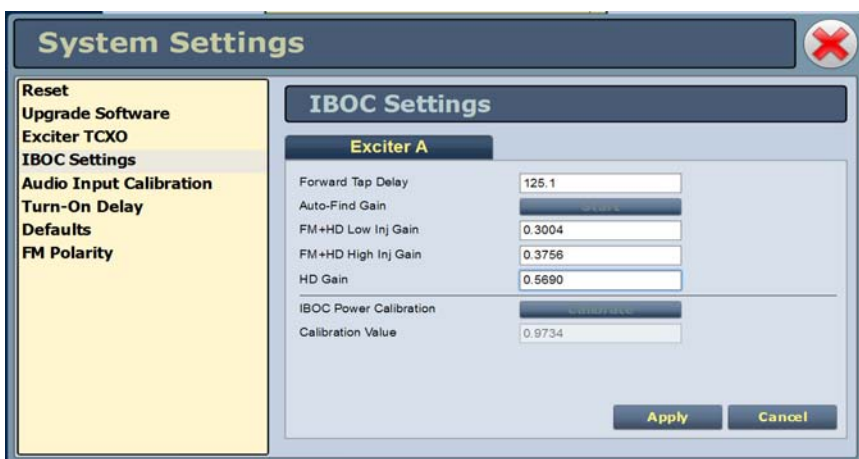

AUDIO INPUT CALIBRATION

This system setting (see [Figure 2.56](#)) supports the calibration of analog and MPX (composite) audio inputs. The peak meter value of each calibrated audio input (**Analog Left Peak**, **Analog Right Peak**, **MPX Peak**, **MPX SCA Peak**, **Int. SCA1 Peak** and **Int. SCA2 Peak**) will be displayed (when the associated audio input source is connected). Enter the calibration value and press **Apply** to save changes. Changes apply to the active exciter (A or B) only. To calibrate the other exciter, switch to the other exciter and repeat the calibration.

Figure 2.56: System Settings - Audio Input Calibration

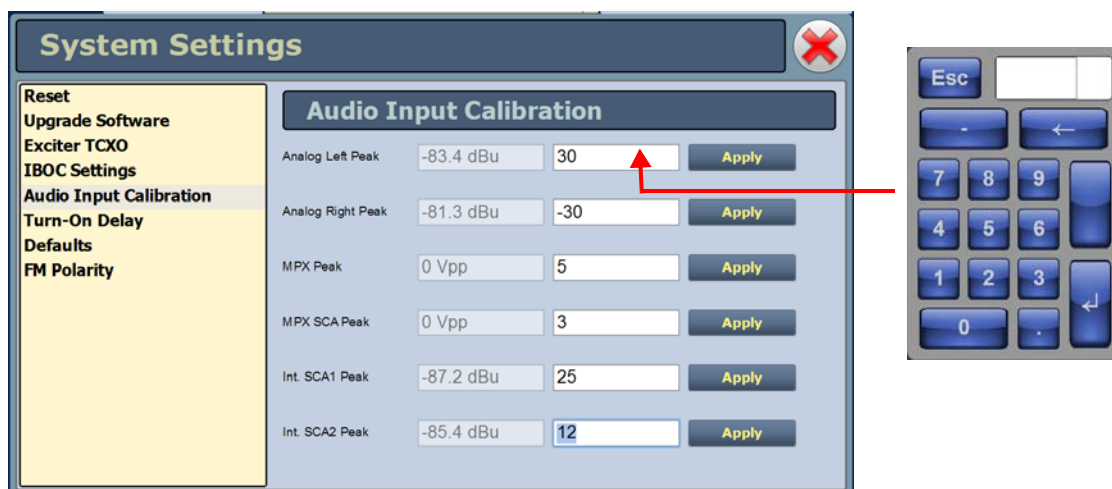

Note:
Audio inputs are factory set using a high accuracy source and do not typically require user adjustment. Changes to factory calibrations could cause low or excessive modulation and noncompliance to strict regulatory limits

TURN-ON DELAY

This system setting (see [Figure 2.57](#)) allows users to delay the start-up (RF on) of the transmitter when recovering from an ac power loss, in order to limit the simultaneous power demand from multiple transmitters on a common generator by staggering their turn on sequence. Enter a value in the allowable range of 0-120 seconds, defaulted to 0 seconds (disabled).

Figure 2.57: Turn-On Delay

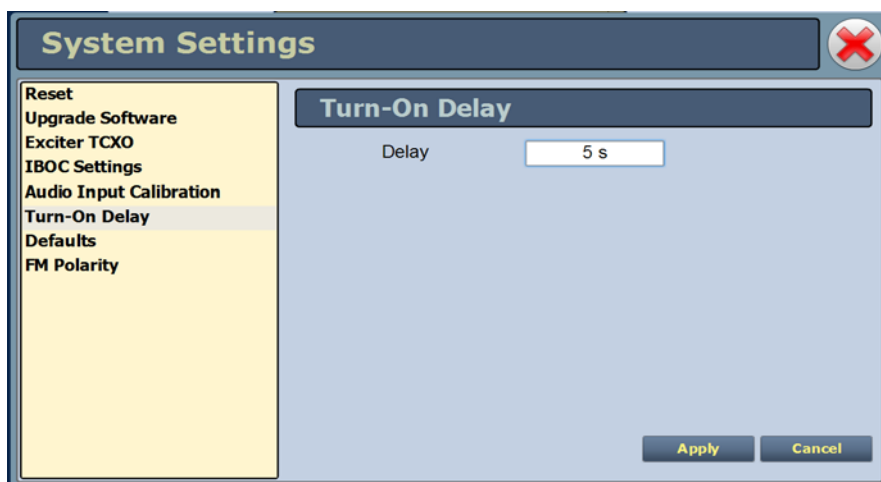

DEFAULTS

The **Defaults** page stores the default settings for RF module IPA bias and PA bias (see [Figure 2.58 on page 2-77](#)) as a function of mode (**Bias** tab). It also stores the default Exciter power level based on transmitter type and default IPA output power (referenced to 98MHz) via the **Power** tab (see [Figure 2.59 on page 2-77](#)). These settings are fixed and should require no adjustment by the user.

The transmitter RF modules store bias values in EEPROM that are pre-determined at the factory for optimal operation of the IPA and PAs for each available mode. These varying levels of bias values are stored in indexes 1 through 5, with index 0 having 0 bias stored (0 being the lowest amount of bias, 5 being the highest). The IPA and PA index values are set based on the bias requirements of each mode.



Note:

The transmitter automatically adjusts the actual IPA Power set-point based on the preset frequency (as a function of a pre-determined frequency response), with the reference power level value being at 98MHz.

Figure 2.58: Defaults - Bias (IPA and PA default index values shown)

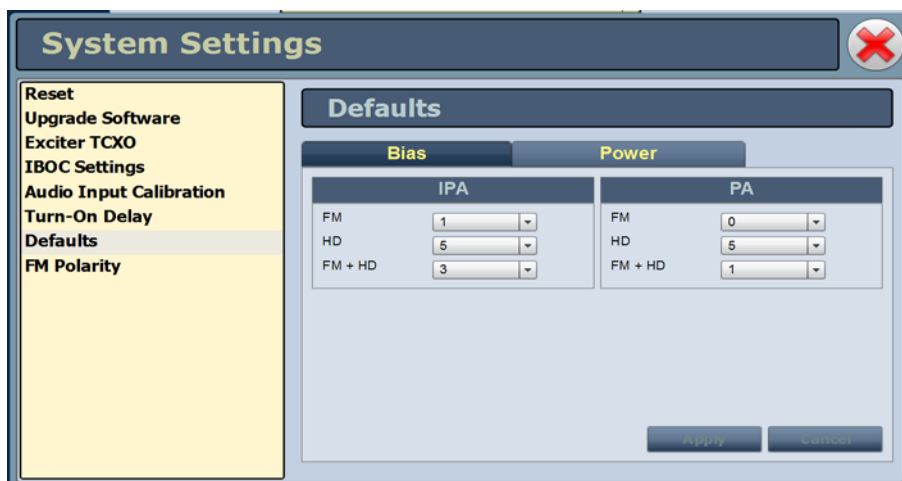
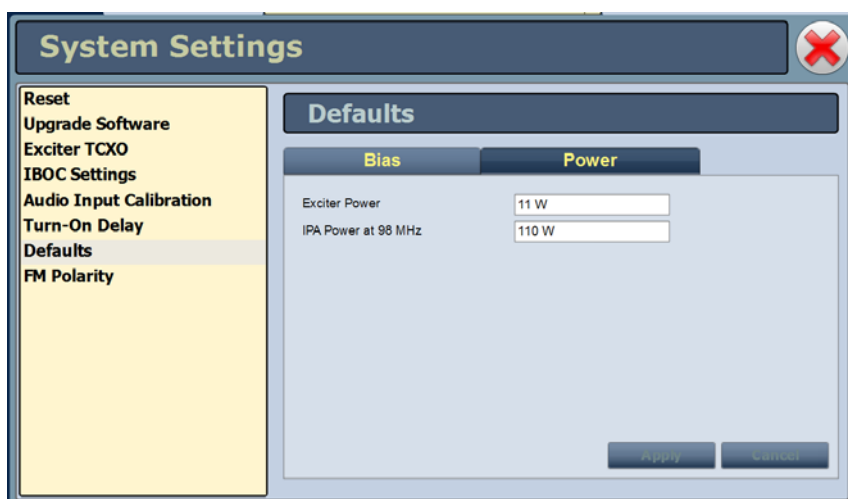

Figure 2.59: Defaults - Power



Note:
 Default Exciter Power is transmitter specific; NV3.5/NV5 = 11W; NV7.5/NV10 = 25W;
 NV15/NV20 = 65W and NV30/NV40 = 130W.

Default IPA Power at 98MHz is 110W.

These values are factory determined and should not require adjustment. These values apply for FM mode only.

FM POLARITY

This system setting (see [Figure 2.60](#)) allows users to invert the polarity of the frequency modulation; (i.e. positive going modulation signal yields positive deviation; or positive going modulation signal yields negative deviation). Options are Normal (default) or Inverted.

Figure 2.60: FM Polarity

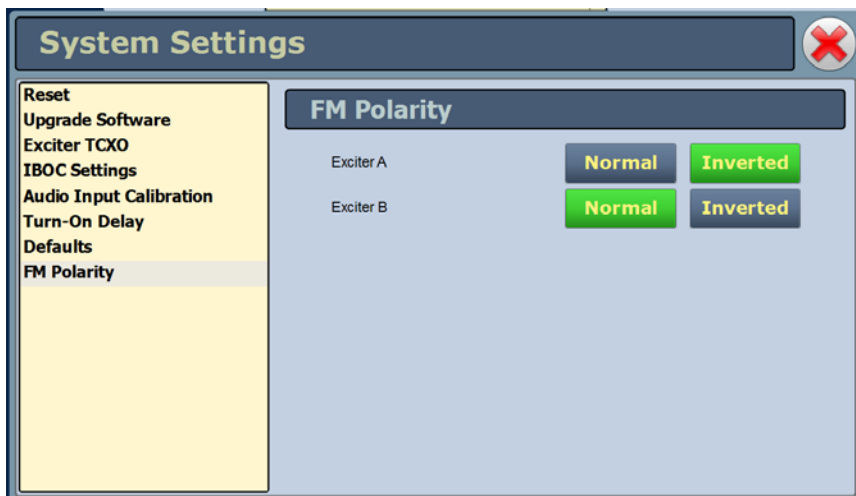

USER ACCOUNTS

Depending on user permission rights, you can set up accounts to allow certain users to access and control features of the AUI using the [User Accounts page](#) - see [Figure 2.61](#). To view the [User Accounts](#) page, select [User Accounts](#) from the [Menu](#) options.



Note:
Depending on the permission level assigned to a given user, some features shown in [Figure 2.61](#) may not be displayed or available.

This section includes the following topics:

- [Setting user permission level on page 2-80](#)
- [Editing account information on page 2-80](#)

Figure 2.61: User Accounts page

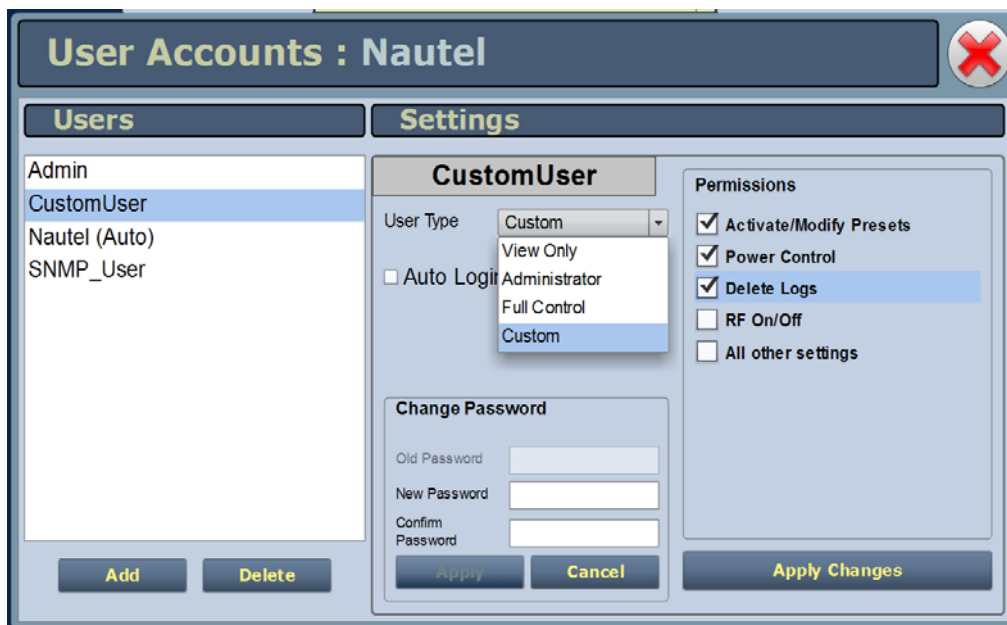

SETTING USER PERMISSION LEVEL

There are four levels of permission that can be assigned to users, each with their own specific function. All users have permission to change their own username and password, but are otherwise limited to the following functions:

- **View Only:** Can monitor equipment data only. No administrative or control functions.
- **Full Control:** Can monitor and control equipment, with no administrative functions.
- **Administrator:** Can perform all functions. **Administrator** is the only permission level that allows addition, removal or modification of users.
- **Custom:** Administrator can customize the user permissions by manually selecting the permission levels.

EDITING ACCOUNT INFORMATION

ADDING AN ACCOUNT

You must be an **Administrator** to use this function.

Procedure to add a user (see [Figure 2.62 on page 2-82](#)):

1. Open the **User Accounts** page.
2. Press **Add** (bottom of the screen) to open a small **Add User** window.
3. Beside **Username**, enter a name that identifies the new user, and press **OK**.
4. Select the new user to edit the settings.
5. Beside **User Type**, press the arrow to reveal a drop-down menu and select a type of user. If you select **Custom** as the type of user, then go to the **Permissions** section of the screen and mark individual permissions (see [Changing permissions on page 2-81](#)).
6. Press **Apply** to confirm your entries and create a new user or press **Cancel** to ignore your entries and exit the small window without creating a new user.

EDITING AN EXISTING ACCOUNT

To edit an existing user account, press on the desired user in the **Users** list on the left-side of the AUI. The **Settings** for that user will be displayed on the right-hand side of the AUI. You can edit the **Password**, **User Type** (see [Setting user permission level](#) above), **Auto Login** status and **Permissions**.

CHANGING THE PASSWORD

To change your password, press the **Change Password** button. A menu appears that prompts you to enter the old password, new password and confirmation of the new password. Press **Apply** to save or **Cancel** to exit this menu (see [Figure 2.62 on page 2-82](#)).

SETTING AUTO LOGIN (LOCAL ONLY) STATUS

When checked () the selected user account will be automatically logged in to the transmitter with all the rights and privileges that have been assigned to that user. There may only be one autologin user at any given time; when the **Auto Login** check box is selected for one user account, it is automatically cleared on all other users. When not checked, the transmitter will not login automatically and will instead prompt for username and password when it boots up. It should be noted that only accounts with **Administrator** level permissions can set or remove **Auto Login** status.

CHANGING PERMISSIONS

You must be an **Administrator** to edit this function.

All users have permission to change their own username and password. You can customize the permissions assigned to a user or simply pick a predetermined set of permissions based on the user type.

Procedure to change user permissions (see [Figure 2.62 on page 2-82](#)):

1. Open the **User Accounts** page.
2. Select a user from the **Users** list to display the permissions for that user in the center of the **Permissions** window. The permissions associated with the selected user are identified with a checkmark ()
3. Press on **User Type** to reveal a drop-down menu and select a new type of user.
4. If the user type in step 3 is **Custom**, set individual permissions. Under **Permissions**, place a checkmark () beside each permission that you want to associate with the user. The boxes work like a toggle - select the checkbox to place a checkmark and select again to remove the checkmark. Choose one or more of the following options:
 - **Activate/Modify Preset** - Allows the user to modify presets and change the active preset.
 - **Power Control** - Allows the user to change the power set point of the transmitter..
 - **Delete Logs** - Allows the user to remove log entries.
 - **RF On/Off** - Allows the user to turn the RF output on and off..

- **All Other Settings** - Allows the user to adjust all settings not mentioned above, except for administrating user accounts.
5. Press **Apply** to assign the new permissions to the selected user.

REMOVING AN ACCOUNT

To remove a user account, select the desired user from the **Users** list and press the **Delete** button. A verification prompt will appear. Press **Yes** to proceed or **No** to cancel the deletion.

Note:
Do not delete the *SNMP_User* account from the list of users.

Figure 2.62: User Accounts Page Layout

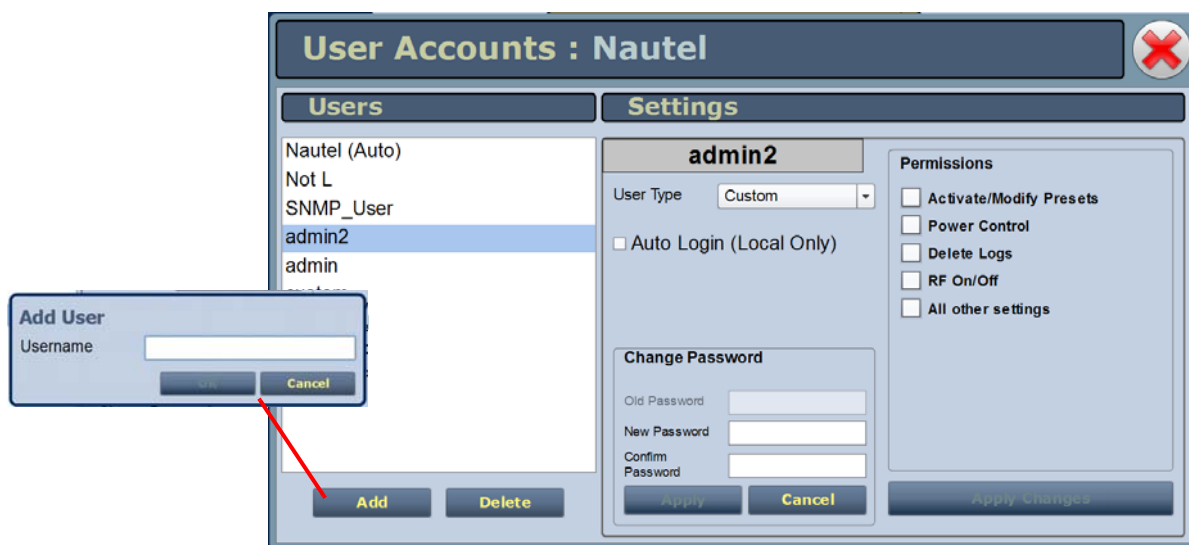

CHANGEOVER PAGE

You can control the auto exciter transfer function using the [Changeover page](#). To view the Changeover page, select **Changeover** from the **Menu** options.

Figure 2.63: Changeover page



The **Active Exciter** is the same as is displayed in the top, right corner of the AUI.

For **Main Exciter**, select **A** or **B**. This will default to **A** if **No** is selected for **Standby Exciter**.

For **Auto Exciter Changeover**, select **Yes** if automatic changeover is desired or **No** if user selected (manual) changeover is desired. **Auto** setting cannot be changed if the selected **Standby Exciter** button is **No**.



Note:

*If standby exciter must be removed for service, Nautel recommends you set Auto Exciter Changeover to **No** while the standby exciter is unavailable for operation, instead of temporarily setting Standby Exciter to **No**.*

For **Standby Exciter**, select **Yes** if standby operation is available or desired or **No** if standby operation is not available or not desired. This is factory set and does not typically require adjustment.

In the **Exciter Changeover Delay** field, enter the desired delay (allowable range is 0-300 seconds, defaulted to 1 second) and press **Set**. The time entered will be added to the pre-existing fixed amount of time required for a changeover to occur once a fault is detected with the active exciter.

USER SETTINGS

The **User Settings** page (see [Figure 2.64 on page 2-85](#)) allows operators to modify various custom user settings such as network and email notification settings.

This section includes the following topics:

- [Setting up the network on page 2-85](#)
- [Email configuration on page 2-88](#)
- [Notifications on page 2-90](#)
- [Configuring engine settings on page 2-91](#)
- [Nautel Phone Home on page 2-93](#)
- [SNMP configuration on page 2-94](#)
- [Critical parameters on page 2-96](#)
- [External 10MHz on page 2-97](#)
- [Digital audio inputs on page 2-98](#)
- [Spectrum mask on page 2-99](#)
- [Time setup on page 2-100](#)
- [NTP servers on page 2-101](#)
- [Audio low thresholds on page 2-102](#)
- [Setting call sign/ID on page 2-103](#)

Figure 2.64: User Settings Page

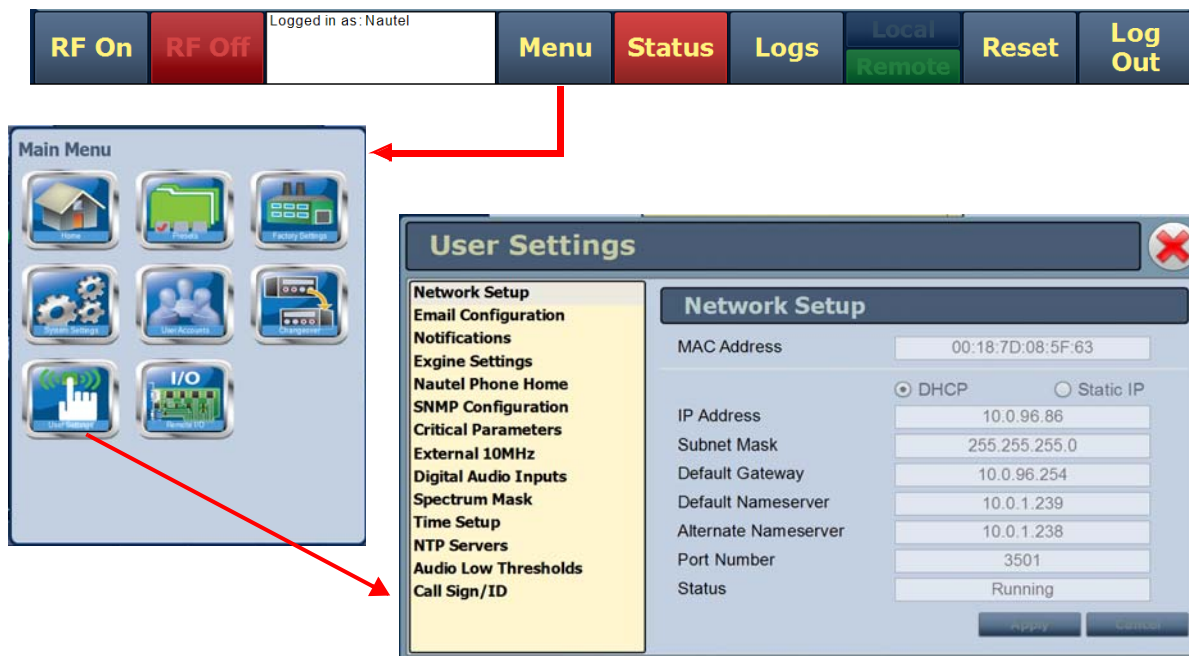

SETTING UP THE NETWORK

The **Network Setup** page (see [Figure 2.65](#)) allows you configure parameters for connecting the AUI to your network. Modify network settings as follows:

Figure 2.65: User Settings - Setting up the Network

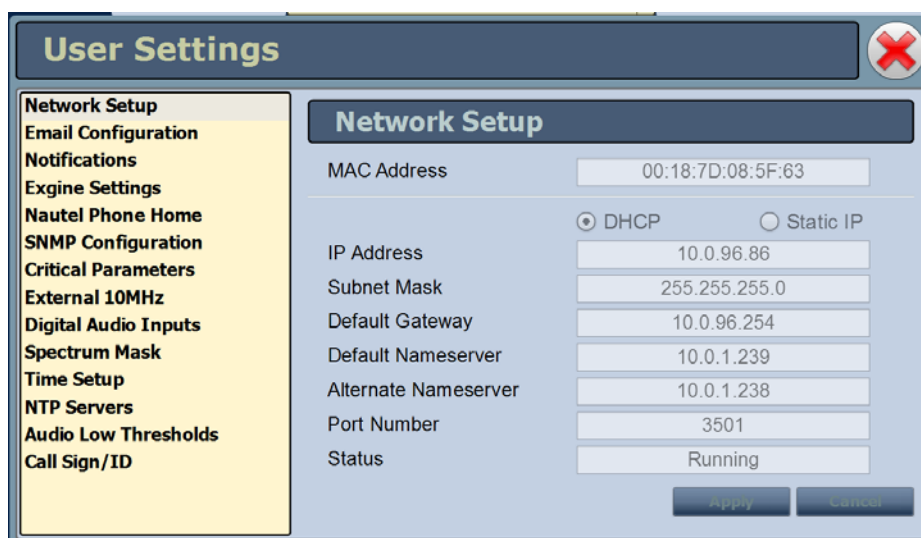

1. Open the **User Settings** page by pressing **Menu/User Settings** on the **Home** page (see [Figure 2.64 on page 2-85](#)).
2. Select the **Network Setup** option (left-side of the screen) to display related information and associated parameters on the right-side of the screen. (see [Figure 2.65 on page 2-85](#)).

**Note:**

Nautel recommends that the following settings be entered/vetted by a qualified Network Administrator.

3. Enter the following parameters (where applicable):
 - **Mac Address** - Displays a number that serves as unique network adapter identifier. This is set by the manufacturer and is displayed for informational purposes only (cannot be user set). It may be necessary to use this number to allow the AUI to access your network.
 - **DHCP or Static IP** - Defines whether the **IP Address**, **Subnet Mask**, **Default Gateway**, **Default Nameserver** and **Alternate Nameserver** will be provided manually (**Static IP**) or automatically by the access point (i.e., a router) through **DHCP**. In either case, the access point must be configured with the correct settings, which match the settings on the AUI in order for the AUI to access the network. Your parameter selection affects other parameter entries. If **Static IP** was selected, enter the **IP Address**, **Subnet Mask** and **Default Gateway**.
 - **IP Address** - displays unique numerical network identifier for the transmitter.
 - **Subnet Mask** - Masks an IP address, and divides the IP address into network address and host address.
 - **Default Gateway** - Defines the address of the network access point.
 - **Default Nameserver** - Address that identifies the DNS host. The DNS (Domain Name System) translates internet domain and host names to IP addresses. DNS automatically converts the name typed into a web browser address bar to the IP addresses of web servers hosting those sites.
 - **Alternate Nameserver** - Redirects the name server.

- **Port Number** - Used to identify the senders and receivers of messages. Also supports port forwarding (remapping) which allows the AUI of multiple NV Series transmitters to be accessed on the same network. See your network router documentation for additional remapping information and instructions.



Note:

Changes to this port are reset to 3501 after a software upgrade and must be reconfigured as required post the upgrade.

- **Status** - Identifies the status of the network.
 - **Running:** transmitter is connected to a network and is functioning properly.
 - **Not Running:** transmitter is not connected or is not functioning properly. When in this state, remote AUI access is not possible.
4. Press **Apply** to accept entries/changes made to the aforementioned parameters.

EMAIL CONFIGURATION

The Email Configuration page (see [Figure 2.66](#)) allows you to configure email parameters (e.g., email server and port number).

Figure 2.66: User Settings - Configuring Email

User Settings

Network Setup
Email Configuration
Notifications
Engine Settings
Nautel Phone Home
SNMP Configuration
Critical Parameters
External 10MHz
Digital Audio Inputs
Spectrum Mask
Time Setup
NTP Servers
Audio Low Thresholds
Call Sign/ID

Email Configuration

Email Server: mail.testing.com
Port Number: 25
Transmitter Name: NV
Sender Email Address: esy@123.org.com.uk
 Authentication Required (AUTH LOGIN)
Username: 123
Password: *****

Test Apply Cancel

Procedure to configure emails:

1. Open the **User Settings** page by pressing **Menu/User Settings** in the **Home** page.
2. Select the **Email Configuration** option (left-side of the screen) to display related information and associated parameters on the right-side of the screen.



Note:

Nautel recommends that the following settings be entered/vetted by a qualified Network Administrator.

3. Enter the following parameters:
 - **Email Server** - The outgoing mail server. Enter the server name or IP address here.
 - **Port Number** - This logical connection end point uses a number to identify the type of process to which an internet or other network message is to be forwarded to when it

arrives at a server. Typically, this is set to 25 for unencrypted SMTP systems and 843 for encrypted email.

- **Transmitter Name** - Enter an identification for the transmitter/station (e.g., NV30_W###). This name will be included in notification emails.
- **Sender Email Address** - Enter as a standard email address (e.g., a@b.com). This will be the sender address that notification email recipients will see. Free web based email service accounts (Gmail, Hotmail, Yahoo mail etc.) are acceptable here.
- **Authentication Required** - If your email server requires authentication to send emails, select the check box and enter the appropriate **Username** and **Password** to authenticate. If the check box is not selected, the **Username** and **Password** fields do not appear.
- **Username** - Enter the username for your outgoing email server.
- **Password** - Enter the password or your outgoing email server.

Note:

The transmitter will automatically handle encryption if the associated mail server requires it.

4. When complete, select **Apply** or **Cancel** to restore the previous settings. Use the **Test** button to enter an email address that a test email will be sent to in order to verify your settings. Enter the recipient address and press the **OK** button to send the test email or press the **Cancel** button to return to the **Email Configuration** page.

NOTIFICATIONS

The **Notifications** page (see [Figure 2.67](#)) allows you to configure email notifications that are sent upon user-selected alarm occurrences.

Figure 2.67: User Settings - Notifications

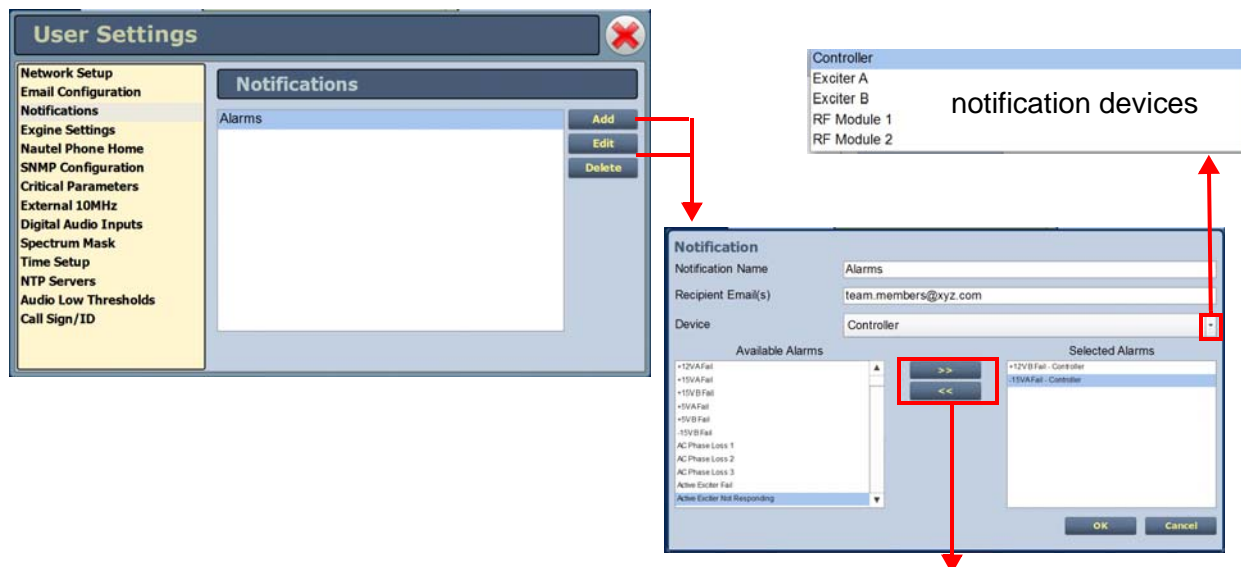

Use arrows to add or remove alarms to be associated with this notification

Procedure to configure notifications:

1. Open the **User Settings** page by pressing **Menu/User Settings** on the **Home** page.
2. Select the **Notifications** option (left-side of the screen) to display a list of pre-existing notifications on the right-side of the screen.
3. Choose from the following options:
 - Press **Add** to add/create a notification. A window opens where you identify the alarms you wish to add to the list of notifications.
 - Select an existing notification and press **Edit** to update/edit the notification with more information. A window then opens that allows you to identify the alarms you wish to update the notification with.

- Select an existing notification and press **Delete** to remove a notification from the list.

The window that opens for both **Add** and **Edit** allows you to edit a notification name, one or more recipient email addresses (separated by a semicolon), and the notification device. Use the arrows (>> and <<) to select alarms by moving them from the **Available Alarms** list to the **Selected Alarms** list.

4. Repeat the previous step, as required, for each notification.
5. When finished, press **OK** to accept your entries or press **Cancel** to ignore your changes and exit this window.

CONFIGURING EXGINE SETTINGS

The **Exgine Settings** page allows you to set signal parameters and determine IP information for use with the Exgine option (see [Figure 2.68 on page 2-92](#)).

Procedure to configure **Exgine Settings**:

1. Open the **User Settings** page by pressing **Menu/User Settings** in the **Home** page.
2. Select the **Exgine Settings** option (left-side of the screen) to display a list of pre-existing notifications on the right-side of the screen. Press **Refresh** to ensure that the latest Exgine configuration information is loaded.
3. Enter the following parameters (if applicable) and press **Apply**.
 - **Digital Carriers** - Select On or Off.
 - **Protocol** - Selects the E2X protocol to use UDP (default) or TCP. Match this setting to the Exporter configuration.
 - **Exgine IP, Netmask and Gateway** - Configure the Exgine's IP network parameters as assigned by the local network administrator. If no gateway is used or assigned, enter 0.0.0.0.
 - **Exporter IP** - Enter the Exporter's IP address of the interface where the data stream is originating. It is used to filter E2X traffic in case multiple exporters are used in broadcast mode on a single LAN. 0.0.0.0 is also a valid configuration.

- **E2X Port** - The engine expects E2X on port 9000. Some non-Nautel Exporters utilize port 11000 instead.
- **Mac Address** - Displays a number that serves as unique network adapter identifier. This is set by the manufacturer and is displayed for informational purposes only. It may be necessary to use this number to allow the AUI to access your network.

Figure 2.68: User Settings - Engine Settings

User Settings

Engine Settings

Digital Carriers	<input checked="" type="radio"/> On <input type="radio"/> Off
Protocol	<input type="radio"/> UDP <input checked="" type="radio"/> TCP
Engine IP	<input type="text" value="10.0.96.198"/>
Exporter IP	<input type="text" value="0.0.0.0"/>
Netmask	<input type="text" value="255.255.255.0"/>
Gateway	<input type="text" value="10.0.96.254"/>
E2X Port	<input type="text" value="9000"/>
MAC Address	<input type="text" value="00:50:C2:59:71:FC"/>

4. When finished, press **Apply** to accept your entries or press **Cancel** to ignore your changes and exit this window.

NAUTEL PHONE HOME

Phone Home is a system developed by Nautel that takes advantage of the vast amount of data collected by Nautel transmitters by proactively sending information to the cloud via the internet once a user enables Phone Home on their transmitter.

This data includes logs, alarms and meter readings which are then stored in a database and can be analyzed by Nautel staff if an alarm is reported by the transmitter. Since all data is pushed out to Nautel by the transmitter to the cloud, there is no need to reconfigure your firewall and potentially compromise your transmitters security. All data transfers are one way.

Nautel transmitters are intelligent, collecting data on nearly every aspect affecting your transmitters performance. When this data is used by Nautel customer support staff for diagnostics purposes it cuts down on repair time and gets you back on air faster.

Nautel customer service technicians can use Phone Home to analyze data in real time, even accessing the live AUI, or to view the state of a customer's transmitter at any time leading up to a fault. This unique diagnostic approach allows Nautel support staff to take a trip back in time and review the events leading up to and during an alarm occurrence, giving customer service technicians valuable insight into how your transmitter is behaving before, during and after an alarm and how this behavior may be related to the alarm event.

Figure 2.69: Nautel Phone Home

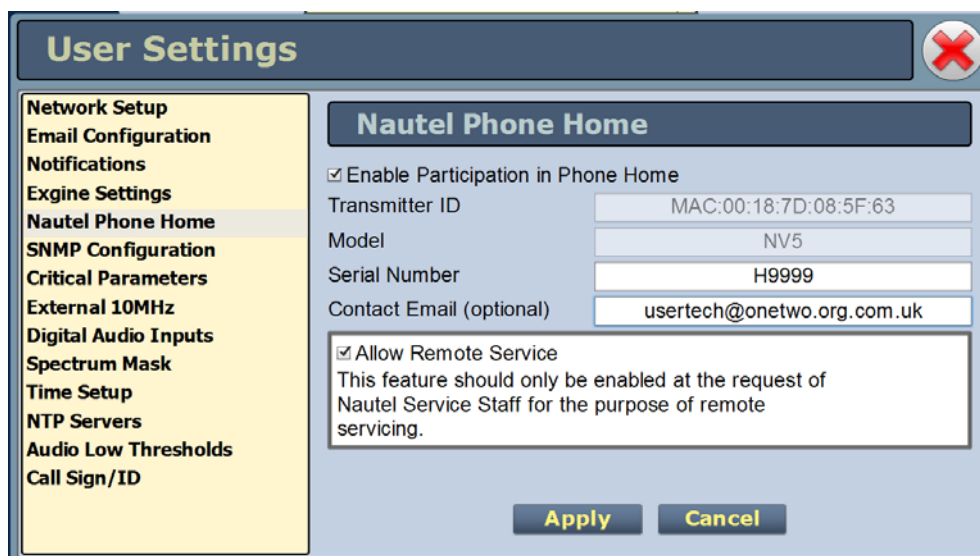

The screenshot shows a 'User Settings' window with a sidebar on the left containing various configuration categories. The 'Nautel Phone Home' category is selected and highlighted. The main content area is titled 'Nautel Phone Home' and contains the following settings:

- Enable Participation in Phone Home
- Transmitter ID: MAC:00:18:7D:08:5F:63
- Model: NV5
- Serial Number: H9999
- Contact Email (optional): usertech@onetwo.org.com.uk
- Allow Remote Service

A warning box below the 'Allow Remote Service' checkbox states: 'This feature should only be enabled at the request of Nautel Service Staff for the purpose of remote servicing.' At the bottom of the window are 'Apply' and 'Cancel' buttons.

SNMP CONFIGURATION

The **SNMP** configuration page provides a user with a means to configure the **SNMP** agent and the associated traps (see [Figure 2.70](#)).

Figure 2.70: User Settings - SNMP Configuration - Agent Tab

The screenshot shows a web-based configuration window titled "User Settings" with a red close button in the top right corner. On the left is a vertical navigation menu with the following items: Network Setup, Email Configuration, Notifications, Engine Settings, Nautel Phone Home, **SNMP Configuration** (highlighted), Critical Parameters, External 10MHz, Digital Audio Inputs, Spectrum Mask, Time Setup, NTP Servers, Audio Low Thresholds, and Call Sign/ID. The main content area is titled "SNMP Configuration" and has two tabs: "Agent" (selected) and "Traps". The "Agent" tab contains the following fields:

- Agent Port: 161
- Read Community: *****
- Confirm: *****
- Write Community: *****
- Confirm: *****
- Enable Traps
- Trap Receiver IP: 0.0.0.0
- Trap Receiver Port: 162

At the bottom right of the main area are "Apply" and "Cancel" buttons.

AGENT SETTINGS

Using the **Agent** tab you can configure the **SNMP** agent as follows:

1. Enter the five fields, noting the following:
 - **Agent Port:** Enter the UDP port where the **SNMP** agent checks for requests. The default setting is 161. If your transmitter is behind a firewall, you must open this port to use **SNMP**.
 - **Read Community:** Enter the password for the **SNMP** client application to allow acquisition of channel values. Provide confirmation of this password by re-entering it in the **Confirm** field.
 - **Write Community:** Enter the password for the **SNMP** client application to allow changing of channel values. Provide confirmation of this password by re-entering it in the **Confirm** field.

Select the **Enable Traps** check box () to allow the **SNMP** agent to send trap notifications. Enter the two additional fields as follows:

- **Trap Receiver IP:** Enter the IP address of the computer to which the SNMP agent will send trap notifications. The computer must be running an SNMP application that is configured to receive traps. The SNMP agent will send trap notifications to only one recipient.
 - **Trap Receiver Port:** Enter the UDP port where the SNMP agent will send traps. The default setting is 162.
2. When complete press **Apply** or press **Cancel** to restore the previous settings.

TRAPS SETTINGS

A trap is an unsolicited message sent by an SNMP agent to an SNMP client when an alarm changes state (turns on or off). The **Enable Traps** check box (☑) must be selected to support this function. The message is an SNMP packet that can be interpreted and displayed by an SNMP client application. Using the **Traps** tab (see [Figure 2.71](#)) select your desired traps as follows:

1. Find the desired alarm(s) by selecting the appropriate **Device** type (**Controller, Exciter, RF Module**, etc.) and scrolling through the **Available Traps** list. Add traps to or remove traps from the **Selected Traps** list using the >> and << arrow buttons.
2. When complete press **Apply** to save or press **Cancel** to restore the previous settings.

Figure 2.71: User Settings - SNMP Configuration - Traps Tab

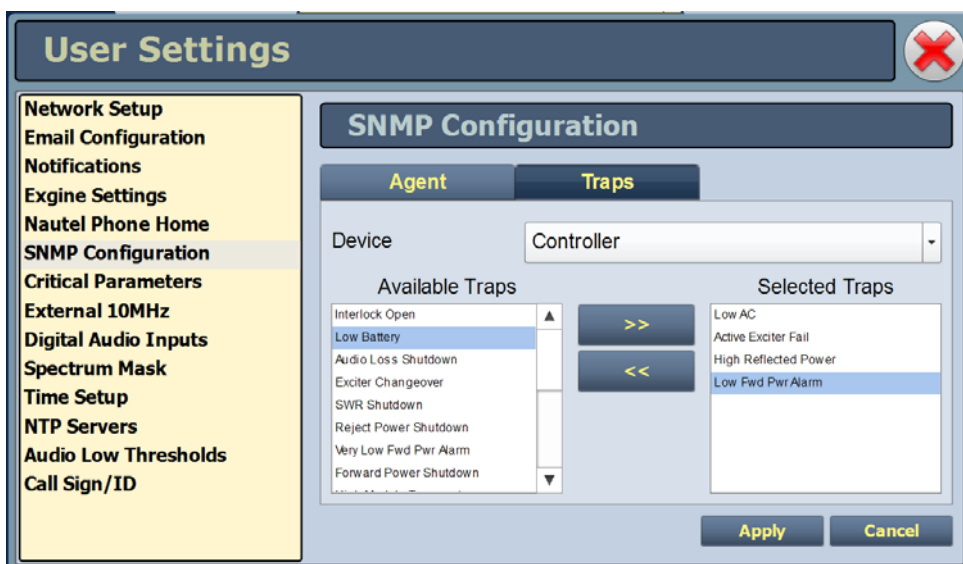

CRITICAL PARAMETERS

This feature is available through the remote AUI only.

You can capture critical parameter data for the transmitter’s current state using the AUI’s **Critical Parameters** page (see [Figure 2.72](#)). To view this page, select **Critical Parameters** from the **User Settings** page. From this page, you can press **Capture Meters** (reads all meter values), **Capture Alarms** (reads all active alarms), **Capture Presets** (reads the current active preset) and **Capture Settings** (reads current settings, e.g., active exciter, threshold settings, scale factors, etc.). Once you press the **Capture** button, you can press the associated **Copy** button to copy the data to your computer’s clipboard facility. The data copies in a tab-delimited format and is ideally suited for pasting into a spreadsheet program.

Figure 2.72: User Settings - Critical Parameters

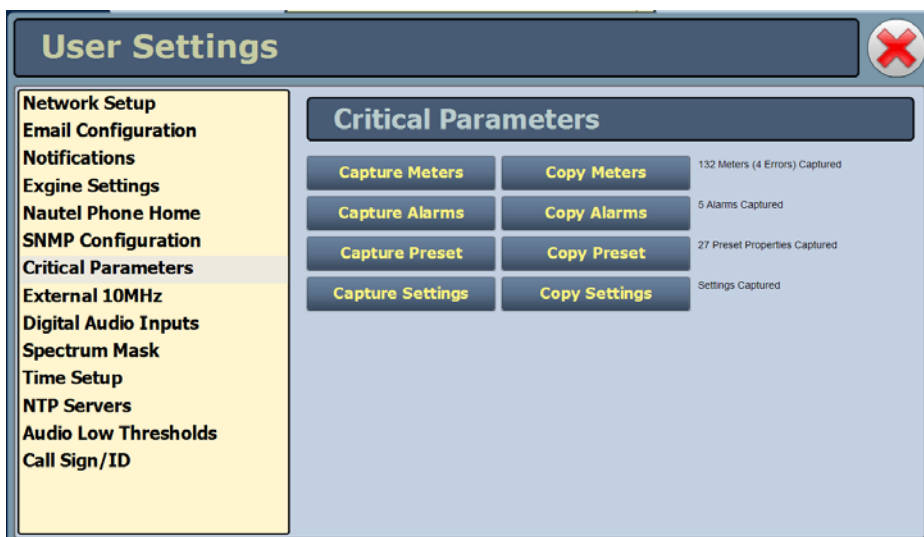

EXTERNAL 10MHz

This setting (see [Figure 2.73](#)) allows the user to mask the associated 10MHz alarm from appearing on the **Status** page if it isn't being used. If an external 10MHz source is being used, **Yes** should be selected as this ensures that an alarm will be activated on the **Status** page should the external signal be lost. If an external 10MHz source is not being used, the default **No** setting should not be changed. This will ensure that no alarm will be displayed on the Status page despite the presence of the external 10MHz signal.

 *Note:*
The exciter will automatically use an external 10MHz reference signal if connected, no matter the state of this parameter.

Figure 2.73: User Settings - External 10MHz (Default shown)



DIGITAL AUDIO INPUTS

The Digital Audio Inputs setting (see [Figure 2.74](#)) allows selection of the input (AES/EBU #1, AES/EBU #2 or Optical) that is mapped to the primary and secondary digital inputs via the presets Audio Source setting.

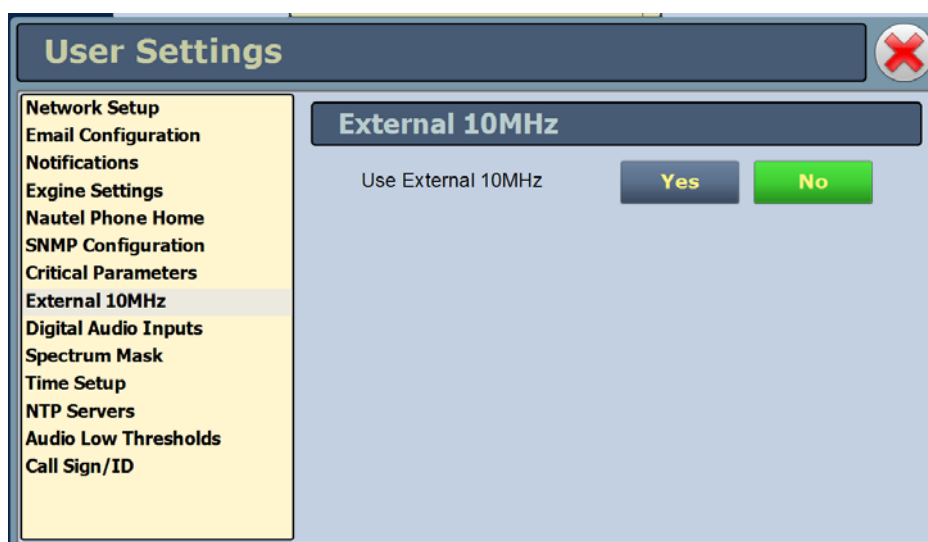
Note: *Optical is only available on certain exciter models. Consult your exciter manual for details on your models hardware configuration.*

Figure 2.74: User Settings - Digital Audio Inputs



SPECTRUM MASK

Using the **Spectrum Mask** setting (see [Figure 2.75](#)) users can select the appropriate FM mask standard (FCC, ETSI or None) being used by the analyzer. The selection affects the mask lines on the Spectrum Analyzer instrument. Use the **Mask Type** pull down menu to select the desired mask (the factory setting is FCC). Press the **Apply** button to save the change or press **Cancel** to discard changes.

Figure 2.75: User Settings - Spectrum Mask

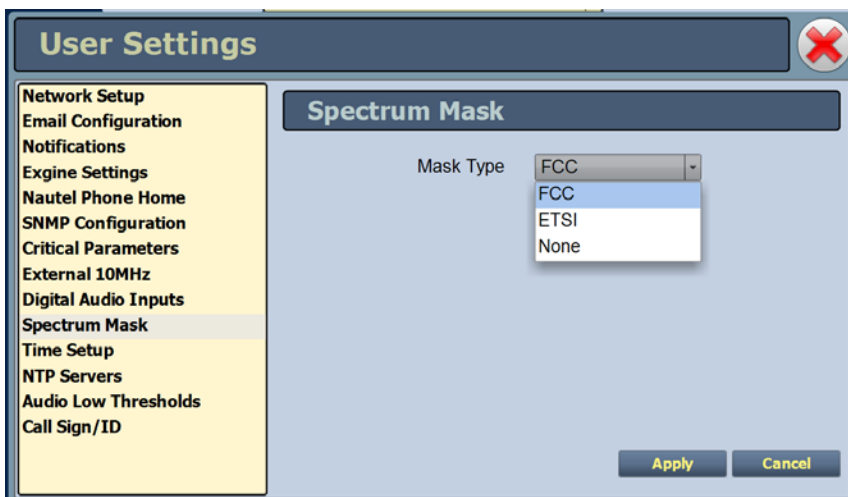

TIME SETUP

There is an internal clock on the transmitter that has a backup battery and maintains the accurate time and date even during power outages. The **Time Setup** page contains editable fields for the date (month, day and year) and time (hours, minutes, and seconds), which is shown on the main screen of the AUI and used for stamping log entries. The clock operates in 24-hour format (see [Figure 2.76](#)).

Set the time and date when the transmitter is first installed and after replacing a backup battery.

Figure 2.76: User Settings - Time Setup

The screenshot shows a web-based configuration interface. On the left is a vertical sidebar with a yellow background containing a list of settings categories: Network Setup, Email Configuration, Notifications, Engine Settings, Nautel Phone Home, SNMP Configuration, Critical Parameters, External 10MHz, Digital Audio Inputs, Spectrum Mask, Time Setup (highlighted), NTP Servers, Audio Low Thresholds, and Call Sign/ID. The main content area is titled 'Time Setup' and features several input fields. The 'Time' section has three dropdown menus for Hour (11), Min (40), and Sec (28). The 'Date' section has three dropdown menus for Day (4), Month (Oct), and Year (2013). Below these are four dropdown menus for Timezone (America/Halifax UTC -3:00), Region (Americas), Country (Canada), and Zone (America/Halifax Atlantic Time - Nova Scotia (most places), PEI). Each section has 'Apply' and 'Cancel' buttons.

The **Time Setup** option allows users to set the exact time and date information as well as regional and timezone settings for a transmitter location.

Procedure to set up the time and date:

1. Select the **Time Setup** option from the left-side of the **User Settings** page to open a related window on the right-side of the page.
2. Enter **Time** and **Date** parameters and press **Apply**. Press **Cancel** to discard changes. Please note that **Time** and **Date** cannot be set via this menu if NTP is enabled (see [NTP servers on page 2-101](#)).
 - **Time** - enter the hour (24-hour clock), minutes (up to 60), and seconds (up to 60).
 - **Date** - select values from the drop-down menus beside **Day**, **Month**, and **Year**.
3. Enter the following location parameters and press **Apply**. Press **Cancel** to discard changes:
 - **Timezone** - automatically set based on **Region**, **Country** and **Zone** selections.
 - **Region** - select the appropriate region from the drop-down menu.
 - **Country** - select the appropriate country from the drop-down menu.
 - **Zone** - select the appropriate zone from the drop-down menu.

NTP SERVERS

You can configure one or more NTP (Network Time Protocol) servers to allow clock synchronization with all computers on the same network as the transmitter. To view the AUI's **NTP Servers** page (see [Figure 2.77](#)), select **NTP Servers** from the **User Settings** options. There are several functions available on this page - enabling NTP, monitoring NTP server status and managing servers.

Note:
The accuracy of the NTP synchronization is related to the distance to the server. For this reason, Nautel recommends that you choose servers in the same country as the equipment. If this is not possible, attempt to connect to servers from the same continent.

Figure 2.77: User Settings - NTP Servers

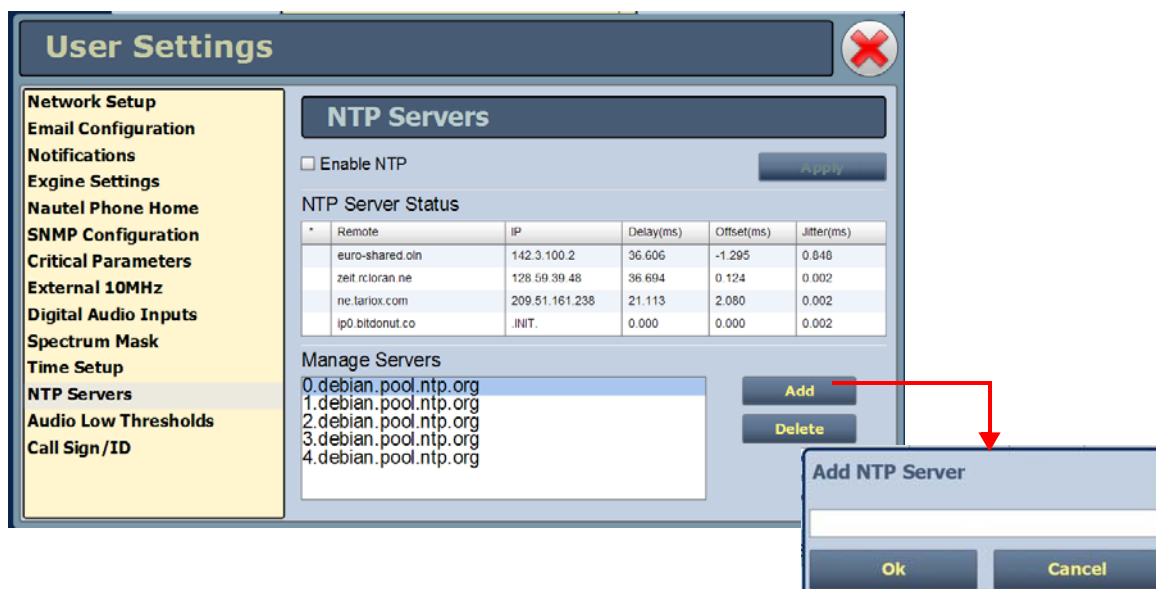

ENABLING NTP

Enable the NTP function by selecting the **Enable NTP** checkbox. Disable by de-selecting the **Enable NTP** checkbox. Press the **Apply** button to activate any change.

MONITORING NTP SERVERS

The **NTP Server Status** section displays tabular information on the NTP servers connected to the network. The table includes remote name, IP address, delay, offset and jitter.

- **Remote Name:** Displays the host name of the referenced time source. An asterisk (*) in the first column marks the reference time source that is currently preferred by the NTP daemon. A '+' character in the first column marks high quality candidates for the reference time that could be used if the currently selected reference becomes unavailable.
- **IP:** Displays the IP address associated with the **Remote Name**. In some cases the **Remote Name** could be the IP address.
- **Delay:** Displays the round-trip delay (in ms) of the time queries.
- **Offset:** Displays the difference (in ms) between the reference time and the system clock.
- **Jitter:** Displays the magnitude of jitter (in ms) between several time queries.

MANAGING NTP SERVERS

The **Manage Servers** section displays the NTP server files that have been added. You can **Add** to the list of NTP servers or **Delete** a selected NTP server from the list.

AUDIO LOW THRESHOLDS

This setting provides adjustable thresholds for the main audio source and SCA audio source (configurable timeout and trip level). These thresholds determine the limit for an associated low audio alarm to be activated. If the applicable audio source (main or SCA) level falls below the **Trip Level** setting (default is -22.5dB) for longer than the **Timeout** setting (default is 20 sec.), an alarm will activate in the **Status** and **Logs** pages. When the audio source level increases above the **Trip Level**, the alarm will clear. To disable the low audio alarm, set the associated **Trip Level** to -100dB. Press **Apply** to save the change or **Cancel** to discard changes.

Figure 2.78: User Settings - Audio Low Thresholds



SETTING CALL SIGN/ID

The Call Sign/ID screen (see [Figure 2.79](#)) allows users to set a name that identifies the transmitter on the AUI. This identification will be displayed in brackets on the top transmitter banner of the AUI (see [Figure 2.80](#)).

Enter the call sign or ID in the field and press **Apply** (maximum 15 characters in length).

Figure 2.79: User Settings - Call Sign/ID

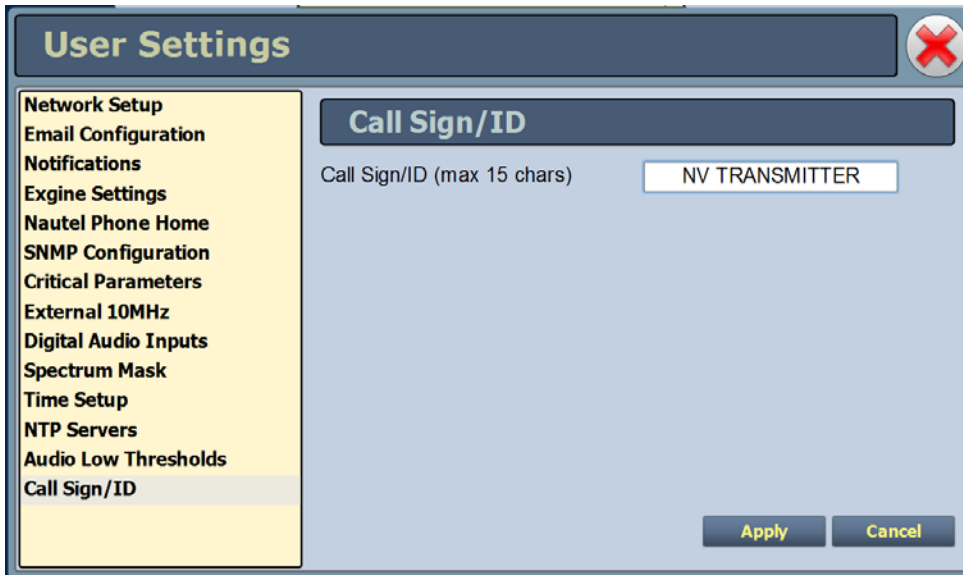

Figure 2.80: Call Sign/ID - Top Transmitter Banner



REMOTE I/O PAGE

You can define and configure your remote input/output interface for the transmitter using the Remote I/O page (see [Figure 2.81](#)). To view the Remote I/O page, select Remote I/O from the Menu options.

Refer also to the *NV30/NV40 Installation Manual* for information on remote inputs and outputs and their factory default settings.

This section includes the following topics:

- [Digital inputs on page 2-105](#)
- [Digital outputs on page 2-107](#)
- [Analog outputs on page 2-109](#)

Figure 2.81: Remote I/O Page (Inputs tab selected)

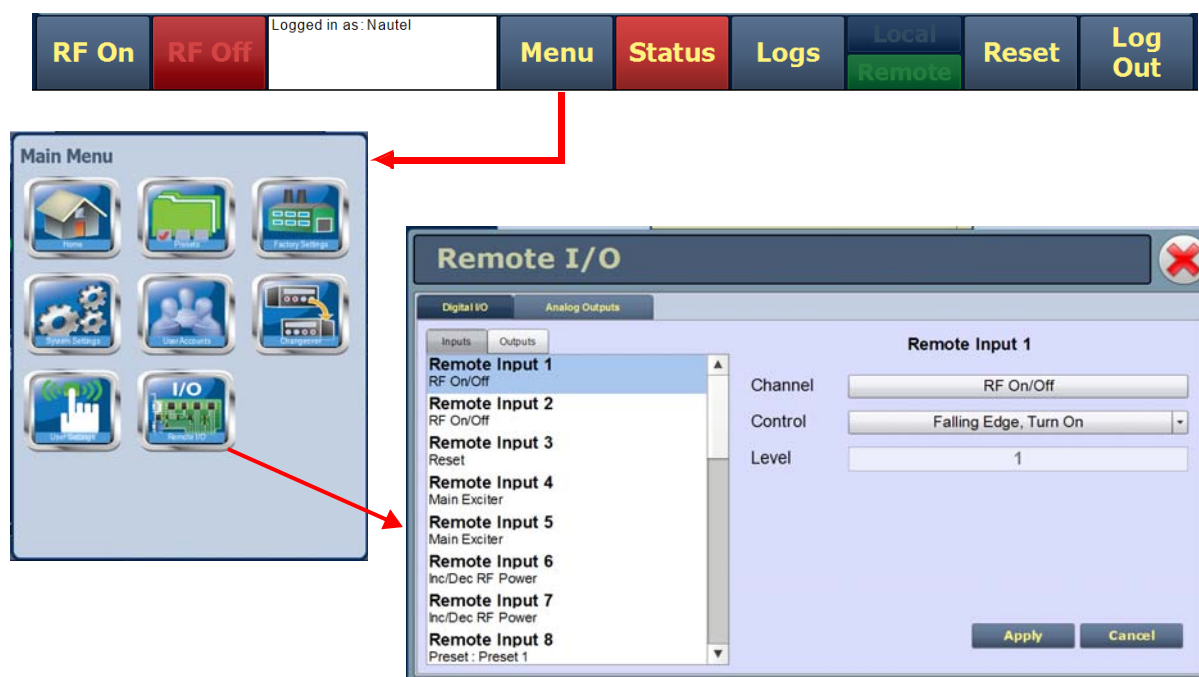

Under the Digital I/O tab, press the **Inputs** (see [Figure 2.82 on page 2-106](#)) or **Outputs** (see [Figure 2.83 on page 2-107](#)) tab to view or edit the configuration of the digital inputs or outputs. Press the **Analog Outputs** tab to configure analog outputs (see [on page 2-109](#)).

DIGITAL INPUTS

Using the **Inputs** tab (see [Figure 2.82 on page 2-106](#)), you can configure up to 24 digital inputs that allow you to remotely control various operational characteristics of the transmitter. Unless otherwise noted these inputs are only accepted by the transmitter if the remote/local status is set to **Remote**. That setting can only be made by a local user using the front panel AUI.

Nautel presets the digital inputs prior to shipping. See the *NV30/NV40 Installation Manual* for a list of default inputs and outputs.

Select the desired digital input (1 through 24) from the list. The **Channel** and **Control** settings for the selected input, as well as the current logic level (1 or 0), are displayed on the right-hand side of the page. You can define the **Channel** and **Control** settings as follows:

CHANNEL

You can configure digital inputs 1 through 24 for one of a variety of control inputs. Press the existing **Channel** bar to display the **Select a Remote** window. From this window select one of the following options and press **OK** to accept:

- **Not Assigned.** No effect on transmitter operation, regardless of logic level.
- **RF On/Off.** Same as pressing the **RF On** (telling the system to provide RF power, if possible) or the **RF Off** button on the local AUI. There are 2 inputs configured by default; one for **Falling Edge, Turn On** and one for **Falling Edge, Turn Off**.
- **Reset.** Causes a system reset. Same as pressing **Reset** button on the local AUI.
- **Inc/Dec RF Power.** Activating these inputs will increment/decrement the preset power level by a fixed amount (100W). Holding the selection will increment/decrement the power level by 100W every 1/2 second. There are 2 inputs configured by default; one for **Active Low, Increase** and one for **Active Low, Decrease**.
- **Main Exciter.** Selects the main exciter to operate the transmitter. There are 2 inputs configured by default; one for **Falling Edge, Set to A** and one for **Falling Edge, Set to B**.
- **Auto Changeover Enabled.** Sets the exciter changeover function to operate automatically. There is only 1 input configured by default; each subsequent activation of the input will toggle the state (enabled/disabled) e.g. **Falling Edge, Toggle**.
- **Watchdog Asserted.** Allows the user to assert a watchdog reset to the AUI, thus rebooting the AUI via a hardware parallel remote input (controlled by a third party remote control unit).
- **Preset: NAME.** Selects the associated preset (from a list of all pre-defined presets) as active.

Figure 2.82: Remote I/O - Digital Inputs

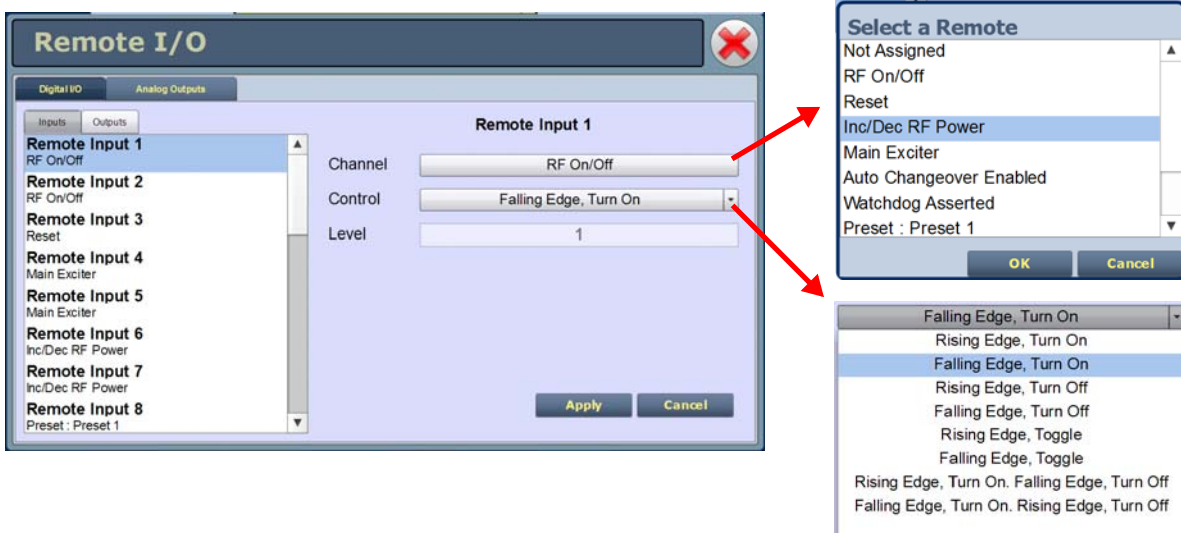

CONTROL

You can configure the active/inactive logic for each of the 24 digital inputs. Press the **Control** bar to display the applicable drop-down menu options, which may include:

- **Falling Edge Turn On/Reset/Set To B.** Logic '0' (low or trailing edge) activates the input (or causes a reset or selects B, as appropriate).
- **Rising Edge Turn On/Reset/Set To B.** Logic '1' (high or rising edge) activates the input (or causes a reset or selects B, as appropriate).
- **Falling Edge Turn Off/Set To A.** Logic '0' (low or trailing edge) de-activates the input (or selects A, as appropriate).
- **Rising Edge Turn Off/Set To A.** Logic '1' (high or rising edge) de-activates the input (or selects A, as appropriate).
- **Falling Edge Toggle.** Logic '0' (low or trailing edge) de-activates the input; next logic '0' (low or trailing edge) activates the input.
- **Rising Edge Toggle.** Logic '1' (high or rising edge) activates the input; next logic '1' (high or rising edge) de-activates the input.
- **Rising Edge, Turn On/Set To B. Falling Edge Turn Off/Set To A.** Logic '1' (high or rising edge) activates the input (or selects B, as appropriate); logic '0' (low or trailing edge) de-activates the input (or selects A, as appropriate).

- Falling Edge, Turn On/Set To B. Rising Edge Turn Off/Set To A. Logic '0' (low or trailing edge) activates the input (or selects B, as appropriate); logic '1' (high or rising edge) de-activates the input (or selects A, as appropriate).
- Active High, Increase. Logic '1' (high) causes a power increase.
- Active Low, Increase. Logic '0' (low) causes a power increase.
- Active High, Turn On. Logic '1' (high) causes applicable preset to become active.
- Active Low, Turn On. Logic '0' (high) causes applicable preset to become active.
- Active High, Decrease. Logic '1' (high) causes a power decrease.
- Active Low, Decrease. Logic '0' (low) causes a power decrease.

Press **Apply** to activate changes. Press **Cancel** to discard changes.

DIGITAL OUTPUTS

Using the [Digital Outputs Page](#) - see [Figure 2.83](#), you can configure up to 24 digital outputs that indicate either the presence of various alarms or the status of operator controlled circuits.

Nautel presets the digital outputs prior to shipping. See the *NV30/NV40 Installation Manual* for details.

Figure 2.83: Digital Outputs Page

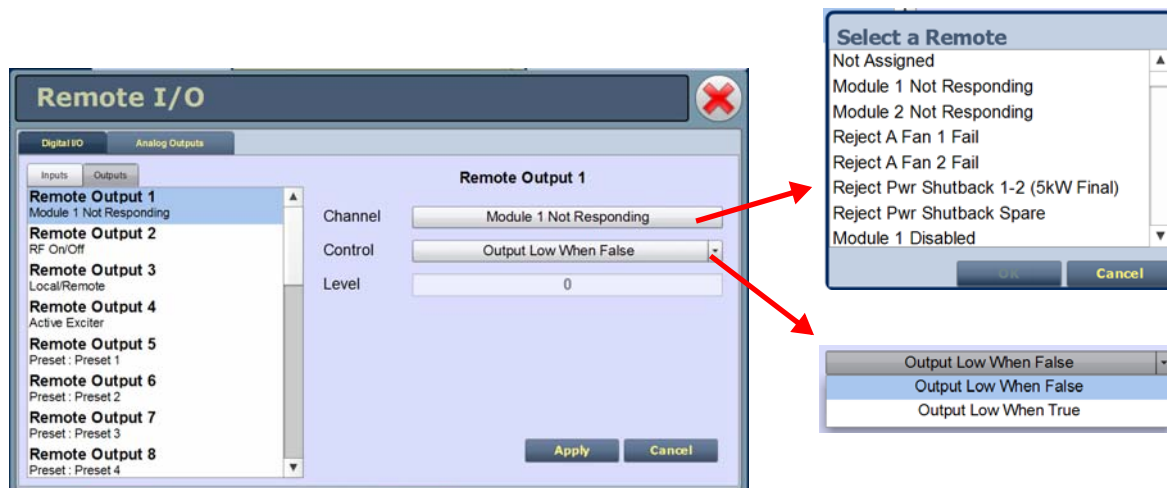

Select the desired digital output (1 through 24) from the list. The **Channel** and **Control** settings for the selected output, as well as the current logic **Level** (1 or 0), are displayed on the right-hand side of the page. You can define the **Channel** and **Control** settings as follows:

CHANNEL

You can configure digital outputs 1 through 24 to monitor a variety of alarm and status outputs. Press the existing **Channel** bar to display the **Select a Remote** window. From this window select one of the channels, then press **OK** to accept.

CONTROL

You can configure the active/inactive logic for each of the 24 digital outputs. Press the existing **Control** bar to display the applicable drop-down menu options. Some digital output default examples:

if the selected channel is **RF On/Off**, the drop-down options are:

- **Output Low When RF On.** Logic '0' (low) indicates the output is true (RF is on); Logic '1' (high) indicates the output is false (RF is off).
- **Output Low When RF Off.** Logic '0' (low) indicates the output is true (RF is off); Logic '1' (high) indicates the output is false (RF is on).

if the selected channel is **Local/Remote**, the drop-down options are:

- **Output Low When Local.** Logic '0' (low) indicates the output is true (Local); Logic '1' (high) indicates the output is false (Remote).
- **Output Low When Remote.** Logic '0' (low) indicates the output is true (Remote); Logic '1' (high) indicates the output is false (Local).

if the selected channel is **Active Exciter**, the drop-down options are:

- **Output Low When A.** Logic '0' (low) indicates the output is true (A); Logic '1' (high) indicates the output is false (B).
- **Output Low When B.** Logic '0' (low) indicates the output is true (B); Logic '1' (high) indicates the output is false (A).

if the selected channel is **Auto Changeover Enabled**, the drop-down options are:

- **Output Low When Enabled.** Logic '0' (low) indicates the output is true (Enabled); Logic '1' (high) indicates the output is false (Disabled).
- **Output Low When B.** Logic '0' (low) indicates the output is true (Disabled); Logic '1' (high) indicates the output is false (Enabled).

if the selected channel is **Preset: Preset 1**, the drop-down options are:

- **Output Low When Active.** Logic '0' (low) indicates the output is true (Active); Logic '1' (high) indicates the output is false (Inactive).
- **Output Low When Inactive.** Logic '0' (low) indicates the output is true (Inactive); Logic '1' (high) indicates the output is false (Active).

if the selected channel is **Modulation Loss**, the drop-down options are:

- **Output Low When True.** Logic '0' (low) indicates the output is true (True); Logic '1' (high) indicates the output is false (False).
- **Output Low When False.** Logic '0' (low) indicates the output is true (False); Logic '1' (high) indicates the output is false (True).

Press **Apply** to activate changes. Press **Cancel** to discard changes.

ANALOG OUTPUTS

There are eight analog outputs that can have their scaling configured to reflect what output voltage yields a full scale deflection (see [Figure 2.84 on page 2-110](#)).

- Forward Power
- Reflected Power
- PA Voltage
- Total PA Current
- RF Drive Power

- IPA Voltage
- Average IPA Output Power
- Controller Temperature

The values associated with each of these fixed meters (cannot be changed to another meter) are of a linear nature so that changes made to the **Full Scale Voltage** field (allowable range is 1- 6 V, defaulted to 6 V) will be reflected in the other fields according to the following equation:

$$(\text{Current Value}/\text{Full Scale Value}) \times \text{Full Scale Voltage} = \text{Current Voltage}$$

 *Note:*
 The *Current Voltage* reading reflects the value that can be measured at the associated remote analog output pin for the given *Current Value*. See the NV series transmitter Pre-installation Manual for actual remote analog output pin assignments.

Press **Apply** to activate changes. Press **Cancel** to discard changes.

Figure 2.84: Analog Outputs Page



Name	Full Scale Voltage	Full Scale Value	Current Voltage	Current Value
1 Forward Power	6.000 V	6 kW	0.000 V	0 kW
2 Reflected Power	6.000 V	700 W	0.000 V	0 W
3 PA Voltage	6.000 V	60 V	0.078 V	0.9 V
4 Total PA Current	6.000 V	240 A	0.000 V	0 A
5 RF Drive Power	6.000 V	25 W	0.000 V	0 W
6 IPA Voltage	6.000 V	60 V	0.000 V	0 V
7 Average IPA Output Power	6.000 V	200 W	0.000 V	0 W
8 Controller Temperature	4.000 V	100 °C	1.191 V	40 °C

SECTION 3: ROUTINE MAINTENANCE

This section provides instructions for performing routine maintenance on the NV30/NV40 transmitter. This section includes the following topics:

- [Scheduled maintenance](#)
 - [Cleaning](#)
 - [Checking hardware - see page 3-2](#)
 - [Battery replacement - see page 3-2](#)
- [Replacing an air filter - see page 3-3](#)
- [Performing on-air checks - see page 3-5](#)
- [Replacing the control/interface PWB battery - see page 3-6](#)
- [Replacing the NVE exciter PWB battery - see page 3-7](#)
- [Inspecting lightning protection systems - see page 3-8](#)

SCHEDULED MAINTENANCE

Scheduled maintenance consists of performing a visual inspection of the NV30/NV40 at scheduled intervals. The recommended minimum time between scheduled maintenance visits is three months. Local operating and environmental conditions may dictate more frequent visits, while in remote sites less frequent visits may be acceptable. Experience and system reliability will determine the most practical schedule for a specific installation.

CLEANING

At a minimum, follow the cleaning procedures listed below.



Note:

A site located in a dirty area using open-air cooling requires more extensive cleaning than a site located in a clean area using closed-air cooling.

1. Check the air filters, noting there are six in the back of the transmitter and one in the front door of the transmitter. Remove the air filters, inspect them, then re-install the air filters if they are clean. If an air filter is dirty or damaged, replace it as soon as possible. See [“Replacing an air filter” on page 3-3](#).

2. Clean the NV30/NV40 using a vacuum cleaner and a soft-bristle brush to remove loose dirt. Clean, damp rags should be used to remove dirt that cannot be removed with a vacuum cleaner. Never use compressed air to clean the NV30/NV40.
3. Clean the 17-inch LCD monitor on the front door as follows:
 - Open the transmitter's front door and gain access to the rear of the LCD monitor.
 - Remove the cover that protects the connectors at the bottom of the LCD monitor, noting it is secured using seven M4 nuts, split washers and flat washers. Retain hardware.
 - Disconnect the round, black **DC INPUT** plug from the bottom, left of the monitor. This removes power from the monitor, which makes it easier to see dirty or oily areas on the screen and also prevents any inadvertent touch-screen operation.
 - Use a dry, soft microfiber cloth and very gently wipe the screen. Do not press hard in an attempt to scrub off dirt or oil. If necessary, dampen the cloth with distilled water
 - When complete, reconnect the **DC INPUT** plug to the monitor and re-install the cover.

CHECKING HARDWARE

All hardware must be checked at least once a year. Thermal cycling from turning the NV30/NV40 on and off will require more frequent checks.

- To prevent damaging the hardware, ensure that the proper sized tools are used. In most cases, hardware is metric.
- A mounting surface or terminal that has changed colour indicates a loose hardware connection.
- Ac input cables installed on terminal block TB1 must be checked and, if necessary, retorqued. See Section 4, Connecting Ac Power of the *NV30/NV40 Installation Manual* to determine specific torque values.

BATTERY REPLACEMENT

The NV30/NV40's control/interface PWB contains a battery backup circuit that provides a memory of transmitter alarm occurrences during ac power failure. See [“Replacing the control/interface PWB battery” on page 3-6](#).

Each exciter's (A or B) NVE exciter PWB contains a battery backup circuit that provides a memory of exciter alarm occurrences during ac power failure. See [“Replacing the NVE exciter PWB battery” on page 3-7](#).

REPLACING AN AIR FILTER

The transmitter contains several cotton air filters, contained in the front door and the upper and lower rear panels. If an air filter becomes damaged, replace it as follows:

INTERVAL

As required.

PARTS AND TOOLS

- Replacement air filter
- Phillips screwdriver

PROCEDURE

Take the following steps to replace an NV30/NV40 air filter:

1. Order a new filter or filters, as necessary. You can order a standard sized filter from Nautel (Nautel Part # HR124) or from the manufacturer (20" x 25" x 2", American Air Filter PerfectPleat HC M8 MERV 8, M7 MERV 7, or equivalent) or obtain one from any local supplier of HVAC supplies.
2. Unpack the new filter and inspect it for damage.
3. Remove the old or damaged filter (see [Figure 3.1 on page 3-4](#)) as follows:
 - For a front door air filter, open the front door and - **for the left-hand AUI door only** - remove the protective metal cover (six M4 screws) just above the fan filter. This allows access to the fan filter bracket's securing screws. Remove the filter bracket's six M4 securing screws (**left-hand door with AUI**) or **eight M4 securing screws (right-hand door)**. Remove the air filter from the bracket.
 - For rear panel filters, loosen the three quarter-turn fasteners at the right-hand side of the appropriate filter panel. Remove the angle bracket from the right-hand side of the filter panel and remove (slide out) the air filter.
4. Insert the new air filter into the bracket. As required, reinstall the filter bracket and protective metal cover for the **left-hand** front door filter, or reinstall the angle bracket on the right-hand side of the rear panel(s).
5. Dispose of the damaged air filter.

Figure 3.1: Replacing Air Filters

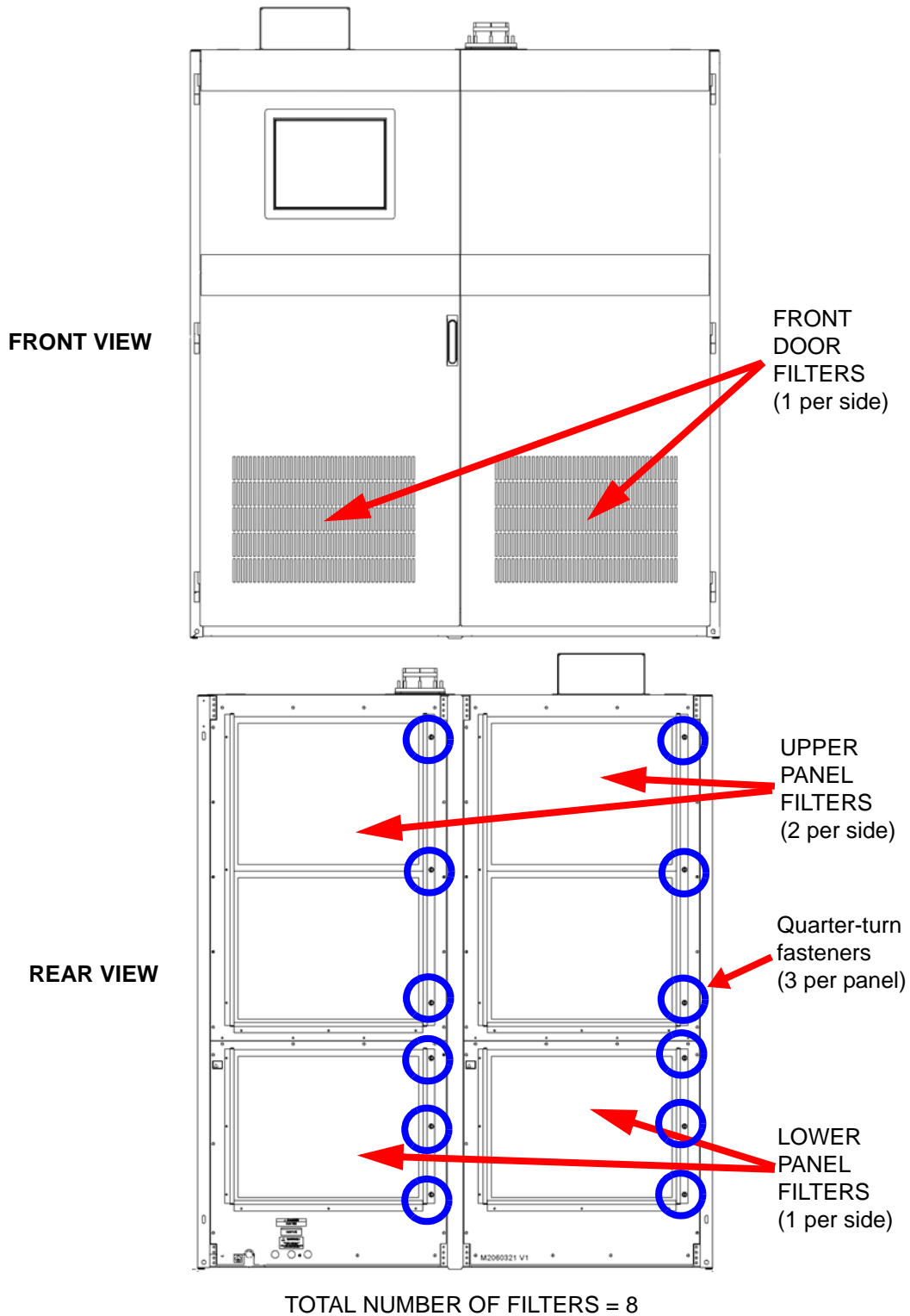

PERFORMING ON-AIR CHECKS

You should check the on-air quality of the transmitter's signal periodically. This check can be done locally at the transmitter site, or remotely from another location in the transmitter's coverage area.

INTERVAL

Every 12 months, or as required by law.

PARTS AND TOOLS

- High-quality receiver compatible with the modulation scheme used on the transmitter.

PROCEDURE

1. Monitor the transmitter signal to identify any problems:
 - Use a high quality receiver to monitor audio quality.
 - Check the spectral output of the transmitter using the front panel AUI's spectrum analyzer.
 - Take a portable receiver to different locations in your coverage areas to identify any problems with the antenna pattern or areas of localized interference.
2. Obtain the *Critical Parameters* sheet that was completed during factory testing and provided with the transmitter. Use the transmitter's AUI to compare current transmitter settings with those on the *Critical Parameters* sheet.



Note:

Nautel completes the Critical Parameters sheet with the transmitter terminated into a precision 50 ohm load. Measurements made on site into a dummy load or station antenna may not yield the same readings. Slight variances are acceptable. The data is provided as a troubleshooting aid.

REPLACING THE CONTROL/INTERFACE PWB BATTERY

Replace the battery on the control/interface PWB (A1) once a year, or whenever the **Controller - Low Battery** alarm appears (on the AUI or via remote digital output). Chemical leakage from an old battery can cause damage. Also, the control/interface PWB's microcontroller may not retain its settings if ac power is turned off while the backup battery power is low. The battery should be replaced while ac power is applied to the transmitter.

INTERVAL

Every 12 months.

PARTS AND TOOLS

Replacement battery: 3 V lithium coin cell, 20 mm (Nautel Part # BBLT01, Panasonic # CR2032).

PROCEDURE

Perform the following steps to replace the battery:

1. Ensure ac power is being applied to the transmitter.
2. Gain access to the control/interface PWB (A1) by opening the left-hand front door of the transmitter.
3. Replace the battery in XBT1 on the control/interface PWB. See Figures MD-1 and MD-3 in the mechanical drawings section at the end of the *NV30/NV40 Troubleshooting Manual* to locate the control/interface PWB (A1) and its battery.
4. Close the left-hand front door.
5. Check for any alarms on the AUI. Battery related alarms should clear. (See [“Viewing transmitter status”](#) on page 2-59.)

REPLACING THE NVE EXCITER PWB BATTERY

Replace the battery on the applicable exciter's NVE exciter PWB (A3A1 or A4A1) once a year, or whenever the **Exciter A/B- Low Backup Battery** alarm appears (on the AUI or via remote digital output). Chemical leakage from an old battery can cause damage. Also, the NVE exciter PWB's microcontroller may not retain its settings if ac power is turned off while the backup battery power is low. The battery should be replaced while ac power is applied to the transmitter.

INTERVAL

Every 12 months.

PARTS AND TOOLS

Replacement battery: 3 V lithium coin cell, 20 mm (Nautel Part # BBLT01, Panasonic # CR2032).

PROCEDURE

Perform the following steps to replace the battery:

1. Ensure ac power is being applied to the transmitter.
2. Open the appropriate front door [left-hand door for exciter A (A3); right-hand door for exciter B (A4)] and - without disconnecting any interconnecting cables - slide the associated exciter forward enough to remove the exciter's cover. See Figures MD-1 in the mechanical drawings section at the end of the *NV30/NV40 Troubleshooting Manual* to locate the exciters. See Figure MD-5 to locate the NVE exciter PWB (A1).
3. Gain access to the appropriate exciter's NVE exciter PWB (A3A1 or A4A1) by removing the cover.
4. Replace the battery in XBT1 on the NVE exciter PWB.
5. Close the appropriate front door.
6. Check for any alarms on the AUI. Battery related alarms should clear. (See [“Viewing transmitter status”](#) on page 2-59.)

INSPECTING LIGHTNING PROTECTION SYSTEMS

You should inspect the lightning protection systems that are connected to your NV30/NV40 transmitter, ac power, RF feedline, antenna and tower periodically to ensure that your site, equipment and personnel are fully protected.

INTERVAL

Every 6 months.

PARTS AND TOOLS

Depends on your site, but may include a digital multimeter, ladder, binoculars, and continuity tester.

PROCEDURE

Perform the following steps to test the lightning protection systems:

1. Test the continuity between ground available at your lightning arrestor and ground available on various pieces of equipment connected to the transmitter. Ensure that there is no resistance (near 0 ohms, accounting for multimeter test lead resistance).
2. Physically inspect the lightning arrestor to ensure that all connections are tight. Also look for any sign of scoring or burning (indications of possible damage from earlier lightning strikes).
3. Using binoculars, visually inspect the hardware on the tower. Look for charred, broken or frayed connections and corrosion.

SECTION 4: NON-STANDARD MAINTENANCE

This section provides instructions for performing non-standard maintenance on the NV30/NV40 transmitter. This section includes the following topics:

- [Upgrading software](#)
- [Improving transmitter performance for IBOC presets - see page 4-4](#)
- [Changing the RF output connector - see page 4-6](#)
- [Bypassing the UPS interface option - see page 4-10](#)

UPGRADING SOFTWARE

Periodically, enhancements or improvements to the operating system are identified and made available. Perform a software upgrade, as required, as follows:

PARTS AND TOOLS

- Laptop (i.e., local computer for direct connection) or network computer with Windows and Internet Explorer Web browser
- CAT5 Ethernet cable
- Upgrade software (*.tgz or *.img file), provided via email, web download or flash card

PRELIMINARY CHECKS

1. Determine the current software revision installed. Via the advanced user interface (AUI) screen, go to **Menu/System Settings/Upgrade Software**. Select the *.tgz file from the Select a Boot Image list (should highlight in blue) and press **About**. Note the current software revision for AUI, Server, Controller, Exciter and RF Modules.
2. Contact Nautel for the most recent software revision and receive a new compact flash card (which contains upgrade *.tgz file) or download *.tgz file to a laptop or network location.
3. If you received a new compact flash card, continue to [“Compact flash card swap” on page 4-2](#). If not, proceed to [“Transferring upgrade file” on page 4-2](#).

COMPACT FLASH CARD SWAP

If you received a new compact flash card with the upgrade *.tgz file, swap the current card with the new card as follows:

1. From the transmitter AUI, go to **Menu/User Settings/Network Setup**, and record your current network settings (IP Address, Subnet Mask, Default Gateway). Contact Nautel for the most recent software revision and receive a new compact flash card (which contains upgrade *.tgz file) or download *.tgz file to a laptop or network location.
2. Unplug the single board computer's (SBC) power connector P8 - located behind a cover on the rear of the door (use 7 mm nut-driver - M4 hardware).
3. Remove the current compact flash card - bottom edge of SBC. Note the orientation of the card.
4. Install the new card, noting orientation, and plug in SBC power connector P8.
5. The AUI should boot up and the transmitter login screen should appear (or the main screen - depending if Auto Login was enabled for the active user).

TRANSFERRING UPGRADE FILE

The following steps assume either the laptop will be used to connect directly to the transmitter **OR** the transmitter and network computer are currently connected to the same network.

TRANSMITTER IP CONFIGURATION

1. From the transmitter AUI, go to **Menu/User Settings/Network Setup**.
2. Record your current network settings (IP Address, Subnet Mask, Default Gateway).
3. If connecting to the transmitter directly with a laptop, select **Static IP** and set as follows:
 - IP Address: 10.10.10.2
 - Subnet Mask: 255.255.255.0
 - Default Gateway: 192.168.1.2

Press **Apply**.

4. Set the transmitter for **Remote** control.

LAPTOP IP SETUP

The following steps assume the operating system is Windows XP. Adapt as required for computers with different operating systems.

1. On the laptop go to **Start Menu/Control Panel/Network Connections/Local Area Network**.
2. In the Local Area Network Status, open the **General** tab and choose **Properties**. Scroll down and highlight **Internet Protocol (TCP/IP)**. Choose **Properties**.
3. In the *Internet Protocol (TCP/IP) Properties* window, select **Use the following IP address**.
4. Enter the following settings:
 - IP Address: 10.10.10.1
 - Subnet Mask: 255.255.255.0
 - Default Gateway: 192.168.1.2
5. In the *Internet Protocol (TCP/IP) Properties* window, select **OK**.
6. In the *Local Area Connection Properties* window, select **OK**.
7. In the *Local Area Connection Status* window, select **Close**.
8. Close the *Network Connections* window.

TRANSFER SOFTWARE UPGRADE FILE TO TRANSMITTER

1. If using a laptop, connect the laptop network interface card to the transmitter LAN port (A1J21 on the control/interface PWB) using a CAT5 Ethernet cable. Open Internet Explorer and search for 10.10.10.2. The transmitter login screen should appear.
2. If using a network computer, open Internet Explorer and search for the IP address recorded in [Step 2 of “Transmitter IP configuration” on page 4-2](#). The transmitter login screen should appear.
3. In the *Internet Protocol (TCP/IP) Properties* window, select **Use the following IP address**.
4. At the transmitter login screen enter:
 - User: “Nautel” or “****”, where **** is the user assigned user name
 - Password: none (default) or “****”, where **** is the user assigned password
5. Navigate through the AUI to **Menu/System Settings/Upgrade Software** and press **Browse**. Locate the software update *.tgz file and press **Upload** to load the file into the transmitter boot image list.

IMPROVING TRANSMITTER PERFORMANCE FOR IBOC PRESETS

After a power or frequency change to an operating FM+HD or HD preset, optimize the transmitter's performance as follows:

PARTS AND TOOLS

- Transmitter's AUI

PRELIMINARY CHECKS

1. Verify the transmitter is operating without fault at the licensed RF output power in FM+HD or HD mode, with standard modulating audio present.
2. Observe (maximize the display size) and save the AUI's existing Spectrum instrument panel (set to display transmitter output) and record the meter readings for Controller - DC-RF Efficiency and Controller - PA Volts (see [“Identifying meter information on a specific sub-device” on page 2-42](#)). Save the Spectrum display by remotely connecting to the AUI and using your keyboard's Print Screen button to copy the image, then paste the image into a compatible application (Paint, Word, etc.). The spectrum plot should indicate at least 3 dB of margin between the IBOC intermodulation products and the blue mask limit lines (see [Figure 4.1 on page 4-5](#)). Maximize the spectrum display size and measure points on the spectrum plot using the cursor (see [“Spectrum Analyser” on page 2-30](#) for details).

IMPROVING PERFORMANCE

1. From the transmitter's AUI, select **Local** control and then go to the **Menu - Presets** page. The active preset is displayed.
2. Click in the HD PA Volts field in the Mode section (see [Figure 4.1 on page 4-5](#)) and reduce the voltage value by 1 V (e.g., change 48.0 to 47.0). Press **Activate**.
3. Observe the Spectrum instrument panel again. Repeat [Step 2](#), as necessary, until the Spectrum's intermodulation products are within 3 dB of the blue mask limit line or at -77 dBc.
4. Verify that the Controller - DC-RF Efficiency meter reading has increased from the value recorded in [Step 2](#) of [“Preliminary checks”](#).
5. Repeat this procedure for all FM+HD or HD presets and if the licensed power level changes.

Figure 4.1: Spectrum Analyzer plot on AUI

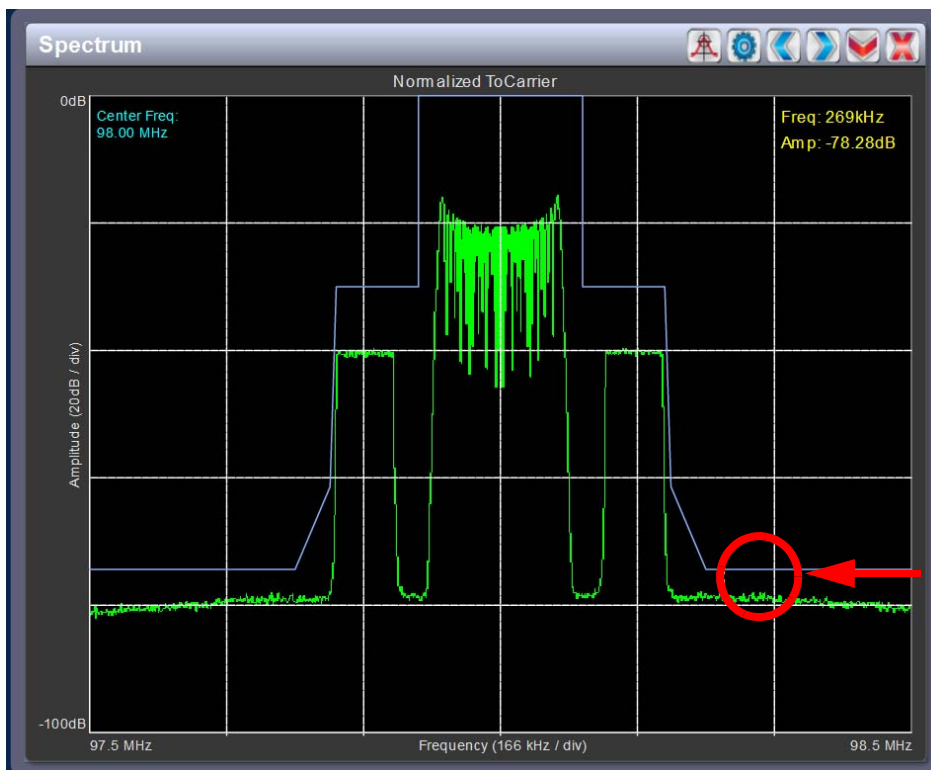

margin between mask and spectrum for intermod products

Figure 4.2: Presets Page - Adjusting HD PA Volts setting

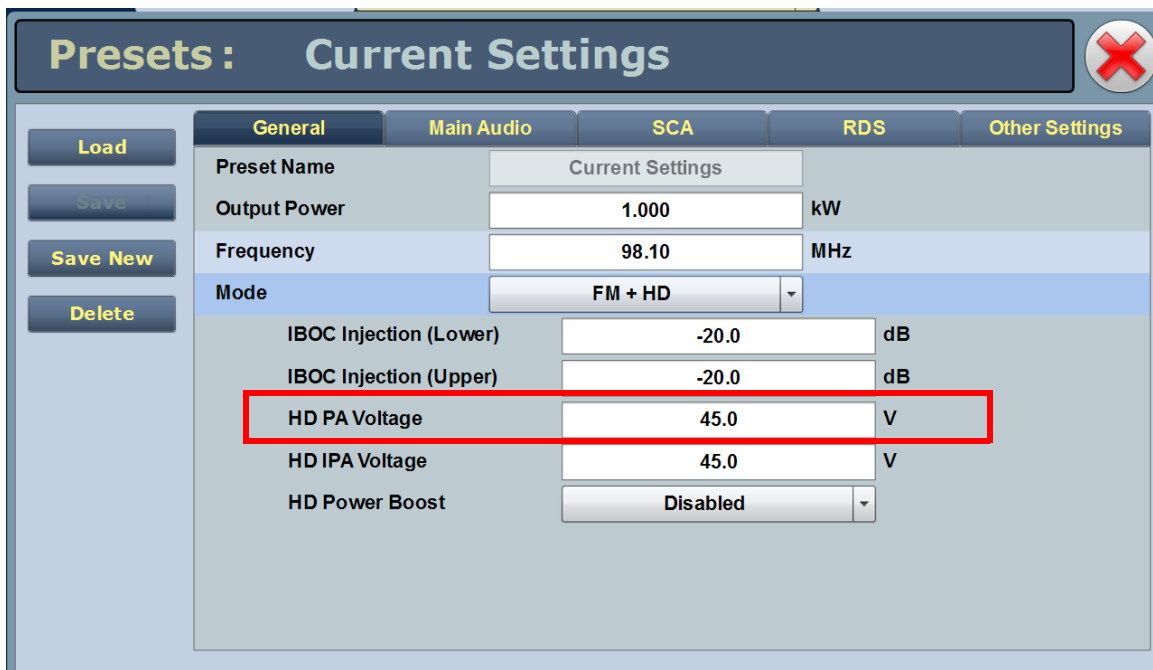

CHANGING THE RF OUTPUT CONNECTOR

If you need to change the size of the RF output connector, replace it as follows:

 *Note:*
Nautel configures the transmitter with the customer's pre-ordered RF output connector. There are various factors that determine the appropriate size of the RF output connector, such as site location (altitude), power level, and available coaxial cable. The coaxial cable must be the same size as the RF output connector to physically fit together.

INTERVAL

As required.

PARTS AND TOOLS

Coaxial cable or hardline that matches new connector size, complete with field flange and inner male (bullet) connector.

Connector kit, available from Nautel. As a minimum, the following options are available:

- 4-1/16 inch EIA, M10 hardware (kit # 206-5224); standard for NV40/NV30
- 3-1/8 inch EIA, M10 hardware (kit # 206-5225-01)

PROCEDURE

Take the following steps to change an NV30/NV40 RF output connector (See Figures 4.1 and 4.2 as guides for assembly and disassembly):

1. Determine the size of the new RF output connector and order the appropriate kit from Nautel (see “Parts and tools” for options).
2. Unpack the new connector kit and inspect the parts for damage.
3. Turn off the transmitter and disable or lock out its ac power source.
4. Remove the old RF coaxial feed cable from the RF output connector, noting it is secured using 3/8 or 5/16 hardware.
5. Remove the old output plate and spacer plates, noting the plates are secured together as well as to the output power probe using eight M6 screws. Retain all hardware.

6. Remove the old output connector cup, noting it is secured to the output power probe with an M10 hex bolt.
7. Install the new output connector cup using an M10 hex bolt.
8. Assemble the new spacer plates and output plate together using hardware retained in [Step 5](#). Install the plates on top of the transmitter and secure to the output power probe using hardware retained in [Step 5](#).
9. Install the new coaxial RF feed cable on the new RF output connector using the 3/8 or 5/16 studs on the stud plate.

Figure 4.3: RF Output Connector Assembly Detail - 4-1/16 inch EIA

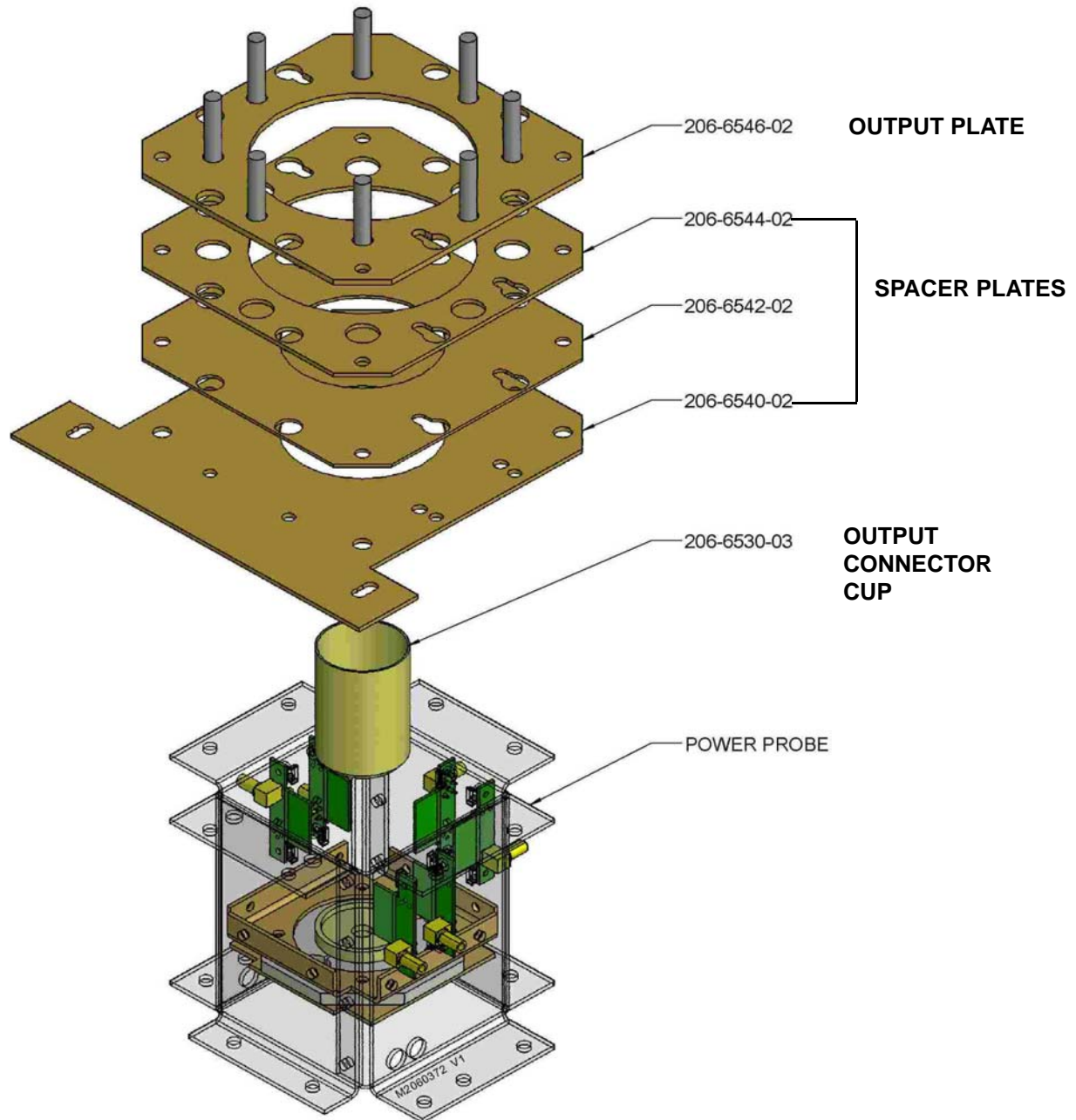
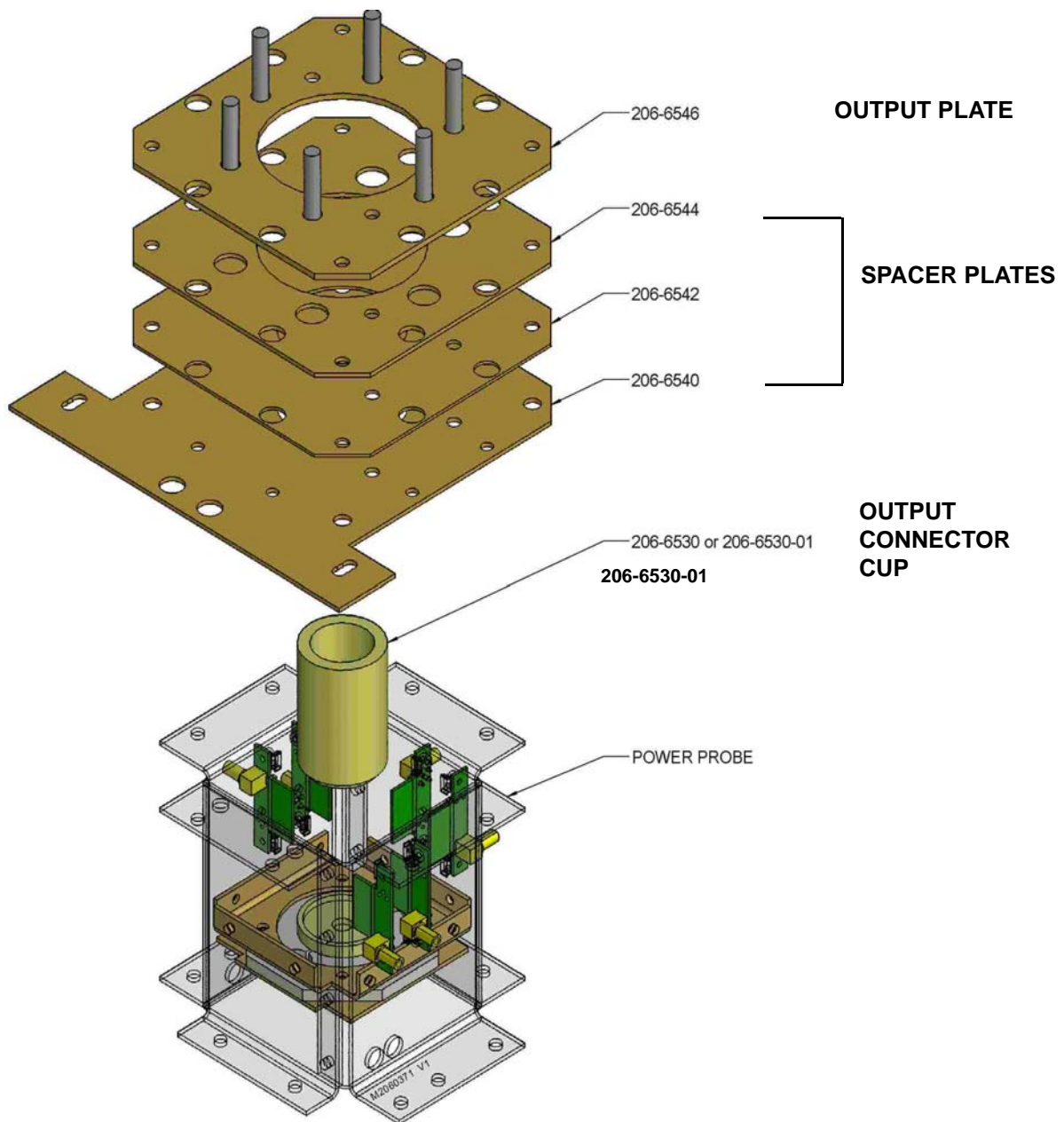

Figure 4.4: RF Output Connector Assembly Detail - 3-1/8 inch EIA



BYPASSING THE UPS INTERFACE OPTION

If you wish to bypass the UPS interface assembly (i.e. disable use of a UPS source), proceed as follows:

INTERVAL

As required.

PARTS AND TOOLS

None.

PROCEDURE

1. Disconnect any user-provided ac power cables connected to the UPS interface assembly at the top of the transmitter.
2. Turn off the transmitter and disable or lock out its ac power source.
3. Open the rear doors of the transmitter.
4. Locate the ac power distribution assembly (A6) (see [Figure 4.5 on page 4-11](#)). Disconnect ac power cables A100W1P2 and A100W2P2 from A6J1 and A6J5 respectively.
5. Locate ac power cables P1 and P4 that are tyrapped into the transmitter's cable harness, near the ac power distribution assembly. Cut the securing tyrap and connect P1 and P4 to A6J1 and A6J5 respectively. Neatly secure the connectors A100W1P2 and A100W2P2 into the cable harness.
6. Close the rear doors of the transmitter.
7. Enable the ac power source and turn on the transmitter. Resume desired operation.

Figure 4.5: Ac Distribution Assembly Location

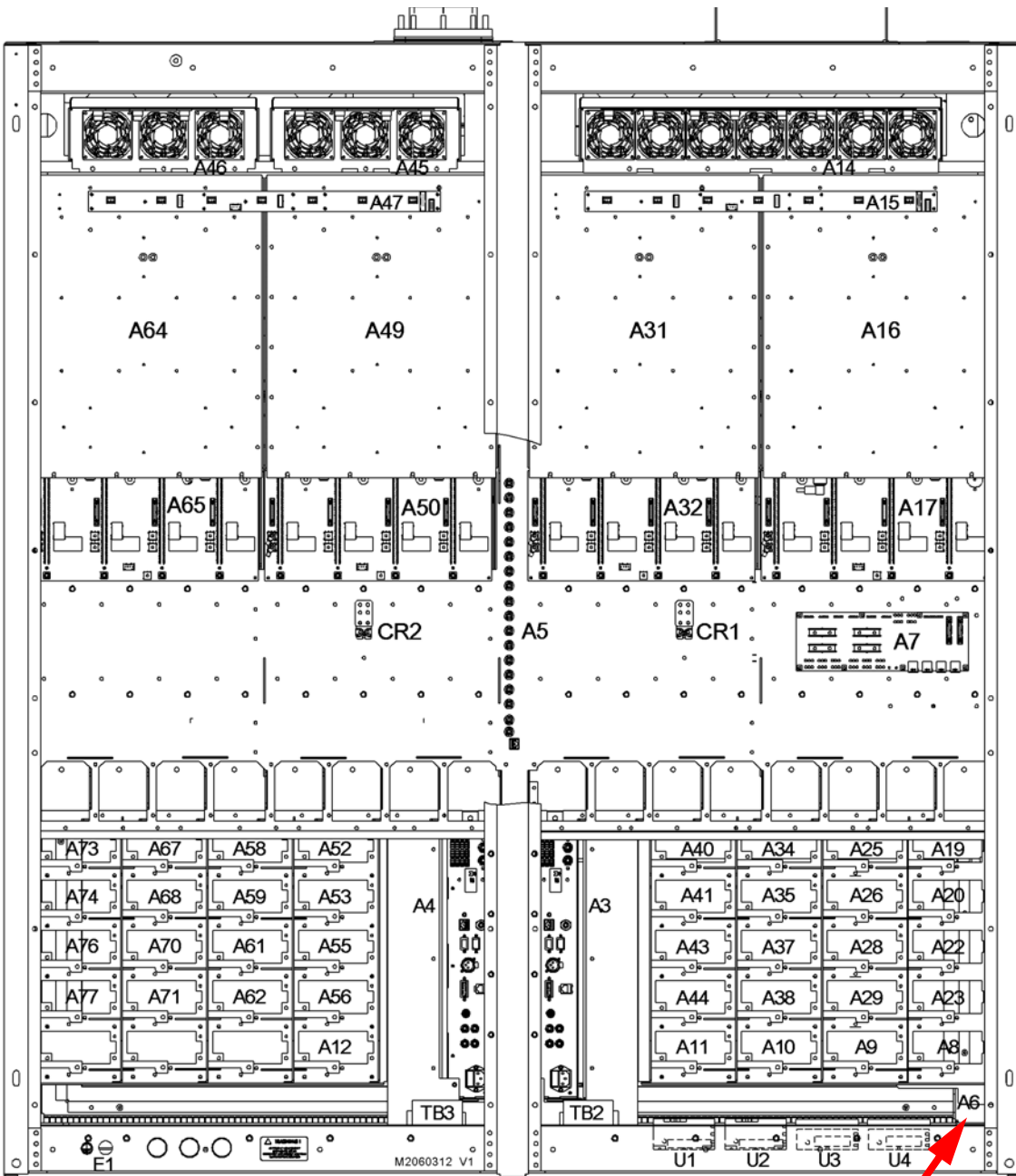

REAR VIEW

AC DISTRIBUTION ASSEMBLY

SECTION 5: LIST OF TERMS

This section defines some of the terms that are used in Nautel documentation.

AES-EBU. Audio Engineering Society/European Broadcasting Union (AES/EBU) is the name of a digital audio transfer standard. The AES/EBU digital interface is usually implemented using 3-pin XLR connectors (the same type connector used in professional microphones). One cable carries both left-channel and right-channel audio data to the receiving device.

AUI. The Advanced User Interface is the 17-inch front panel that allows for extensive control and monitoring of the transmitter.

CUTBACK. A reduction in RF output power, caused by the occurrence of multiple shutbacks within a pre-defined period.

DHCP. Dynamic Host Carrier Protocol.

DSP. Digital Signal Processing.

EEPROM. Electrically Erasable Programmable Read-Only Memory.

FOLDBACK. A reduction in RF output power, caused by transmitter not achieving the desired set point power level (typically this is related to high VSWR).

HD RADIO. High Definition (HD) Radio is another term for In-Band-On-Channel (IBOC) technology. HD Radio is a trademark of iBiquity Digital Corporation.

IBOC. Nautel In-Band-On-Channel technology provides high quality digital audio over existing FM radio channels.

INTERMEDIATE POWER AMPLIFIER (IPA). Refers to circuitry within the transmitter's RF power modules which amplifies the exciter's RF output to a level sufficient to drive the final RF amplifiers.

LED. Light Emitting Diode (also referred to as lamp).

LUT. Look-Up Table.

MER. Modulation Error Ratio. This ratio quantifies (in decibels) the performance of a digital radio transmitter.

OFDM. Orthogonal Frequency Division Multiplexing is a digital data encoding method that uses multiple narrowband carrier frequencies.

PRESET. A setting that controls power level, frequency and audio parameters. The NV30/NV40 allows you to pre-program multiple presets.

PWB. Printed Wiring Board.

SBC. Single Board Computer. Refers to the CPU and associated components located on the back of the transmitter's front door.

SHUTBACK. A complete, but temporary loss of RF output power, caused by any one of a variety of faults, including high VSWR, high reject load power, RF drive failure, or an open external interlock.

SHUTDOWN. A complete and permanent loss of RF output power. Typically follows repeated cutback, foldback or shutback events.

SURGE PROTECTION PANEL. An electrical panel that protects equipment from electrical surges in the ac power supply, antenna or site ground caused by lightning strikes.

TCP. Transmission Control Protocol. This is a connection based message delivery protocol that provides error-checked delivery of a stream of data.

UDP. User Datagram Protocol. This is a connectionless based data delivery protocol that doesn't provide error-checked delivery acknowledgement.

VSWR. Voltage standing wave ratio. This is an expression of the ratio of forward voltage to reverse voltage on the feedline and antenna system. An ideal VSWR of 1:1 provides maximum transmitter-antenna efficiency.

NV30/NV40 OPERATIONS AND MAINTENANCE MANUAL

Document: NHB-NV30-NV40-OPS-3.3

Issue: 3.3 2014-12-10

Nautel Limited

10089 Peggy's Cove Road
Hackett's Cove, NS Canada B3Z 3J4

Toll Free: +1.877.6NAUTEL (662.8835)
(Canada & USA only) or

Phone: +1.902.823.3900 or

Fax: +1.902.823.3183

Nautel Inc.

201 Target Industrial Circle
Bangor, Maine USA 04401

Phone: +1.207.947.8200

Fax: +1.207.947.3693

Customer Service (24-hour support)

+1.877.628.8353 (Canada & USA only)

+1.902.823.5100 (International)

Email: support@nautel.com

Web: www.nautel.com

© Copyright 2014 NAUTEL. All rights reserved.

