



3: OPERATIONS & MAINTENANCE MANUAL

NV20LT/NV15LT TRANSMITTER

Document ID: NHB-NV15LT-NV20LT-OPS
Version: 4.0
Issue Date: 2018-02-26
Status: Standard



Contact Information

Nautel Limited

10089 Peggy's Cove Road
Hackett's Cove, NS Canada B3Z 3J4

Toll Free: +1.877.6NAUTEL (662.8835)
(Canada & USA only) or

Phone: +1.902.823.3900 or

Fax: +1.902.823.3183

Nautel Inc.

201 Target Industrial Circle
Bangor, Maine USA 04401

Phone: +1.207.947.8200

Fax: +1.207.947.3693

Customer Service (24-hour support)

+1.877.628.8353 (Canada & USA only)

+1.902.823.5100 (International)

Email: support@nautel.com

Web: www.nautel.com

The comparisons and other information provided in this document have been prepared in good faith based on publicly available information. For verification of materials, the reader is encouraged to consult the respective manufacturer's most recent publication on the official website or through contact with Customer Service.

© Copyright 2018 NAUTEL. All rights reserved.

CONTENTS

Contact Information	3.iii
<hr/>	
RELEASE CONTROL RECORD	3.vii
<hr/>	
DESCRIPTION	3.1.1
Ac-Dc Power Stage	3.1.1
Control/Monitor Stage	3.1.3
RF Drive Stage	3.1.4
RF Power Stage	3.1.5
<hr/>	
OPERATING THE TRANSMITTER	3.2.1
User Interface Options	3.2.4
Advanced User Interface (AUI)	3.2.9
Controller Front Panel	3.2.17
Home Page	3.2.24
Viewing Transmitter Log	3.2.27
Viewing Tool Menu Panels	3.2.37
Viewing Real-Time Meters	3.2.53
Presets - Editing Operational Settings	3.2.60
Resetting Alarms	3.2.104
Viewing Transmitter Status - using the AUI	3.2.105
System Settings	3.2.107
User Accounts	3.2.137
Changing Exciter Transfer Settings	3.2.141
User Settings - AUI	3.2.144
User Settings - Controller UI	3.2.172
Configuring Remote Inputs and Outputs	3.2.179
Preset Scheduler	3.2.193
Audio Player	3.2.196

Enabling and Operating the Orban Audio Processor	3.2.202
--	---------

ROUTINE MAINTENANCE	3.3.1
Scheduled Maintenance	3.3.1
Replacing an Air Filter	3.3.3
Performing On-Air Checks	3.3.6
Replacing the Controller Module’s Battery	3.3.7
Inspecting Lightning Protection Systems	3.3.9

NON-STANDARD MAINTENANCE	3.4.1
Upgrading Software	3.4.1
Touchscreen Calibration	3.4.4
Configuring a Mod Loss Backup Preset	3.4.5

LIST OF TERMS	3.5.1
----------------------	--------------

RELEASE CONTROL RECORD

ISSUE	DATE	REASON
4.0	2018-02-26	Release 4 of NV20LT/NV15LT (NARF73C/01). Supports software release NVLT SW 4.4.

SECTION 3.1: DESCRIPTION

This section provides a high-level description of the transmitter's key sections. The transmitter circuitry is subdivided into four basic stages:

- Ac-Dc Power Stage
- Control/Monitor Stage - see page 3.1.3
- RF Drive Stage - see page 3.1.4
- RF Power Stage - see page 3.1.5

Refer to the functional block diagram, Figure 3.1.1 on page 3.1.9.

NV20LT/NV15LT Electrical Schematics

Some descriptions in this section refer to electrical schematics (SD-#s). These are located in Section 4 of the NV20LT/NV15LT Troubleshooting Manual.

Ac-Dc Power Stage

See electrical schematic Figures SD-1A/B/C and SD-2. The ac-dc power stage provides power to operate the low voltage power supplies, which generate the 40 to 48 V dc voltage that is converted to the low level dc voltages (± 15 V and +5 V) used throughout the transmitter. This voltage is also conditioned to operate cooling fans in the RF power module, reject load assemblies and splitter assembly. The ac-dc power stage also converts the ac power source to a positive dc voltage (PA volts) for the transmitter's RF power amplifiers and exciter(s). The transmitter accepts a wide range of ac input voltage options:

- ❖ 3-phase, **175 - 265 V ac (208 V ac nominal)
- ❖ 3-phase, **303 - 459 V ac (380 V ac nominal)
- ❖ 1-phase, **175 - 265 V ac (240 V ac nominal)

NOTE: ** - The NV20LT/NV15LT's full ac input range is 90 - 265 V ac (or 156 - 459 V ac, as applicable), but RF output power is limited when the voltage is less than 175 V ac (or 303 V ac, as applicable).

The ac-dc power stage comprises ac input terminal block TB1, power supply interface PWBs (A1 and A17), low voltage power supply (LVPS) modules 1A (U2), 1B (U3, if purchased), 2A (U12, if purchased) and 2B (U13, if purchased), and power supply modules (U4 through U11 and U14 through U21), two for each of the eight RF power modules. There are three amber LED pilot lamps (DS1 through DS3), located in the bottom, rear of the cabinet, that indicate the presence of each ac phase. Ac voltage is distributed from TB1 to TB2 (power rack 1) and TB3 (power rack 2).

Power Supply Interface PWBs

See electrical schematic Figures SD-1A/B/C and SD-2. Each power supply (PS) interface PWB (A1 and A17):

- ❖ interfaces between the ac input on terminal blocks TB2 (PWB A1), TB3 (PWB A17) and the LVPS and power supply modules.
- ❖ distributes LVPS voltage to the RF drive (exciter) stage and the control/monitor stage.
- ❖ distributes PA voltage to the RF power stage and the control/monitor stage.
- ❖ controls, with the controller module, the LVPS output voltage.
- ❖ provides RS485 serial communication between the module control/interface PWB and the RF power module power supplies.
- ❖ allows ac input configuration of the LVPS modules if the UPS option is installed.
- ❖ provides status and alarm outputs from the LVPS and power supply modules, consisting of Module Present, Power Fail Warning, Rectifier Fault and Overtemp Warning (provided to the module control/interface PWB over a serial bus).

LVPS Modules

See electrical schematic Figure SD-2. LVPS modules 1A (U2), 1B (U3, if purchased), 2A (U12, if purchased) and 2B (U13, if purchased) convert the ac input voltage to the regulated output (40 - 48 V dc, nominally 40 V) that is applied to, and controlled by, the controller module via the module control/interface PWB. +5 V, +15 V and -15 V regulated outputs are developed from the LVPS output voltage (40 - 48 V dc) on the module control/interface PWBs. Each LVPS module senses excessive temperature conditions and applies an Overtemp Warning signal (for indication purposes only) to the module control/interface PWB. Each LVPS module also has a low power capacity to allow operation at lower ac input voltages with a user-provided UPS.

Power Supply Modules

See electrical schematic Figure SD-2. Power supply modules U4 through U11 and U14 through U21 convert the ac input voltage to a regulated dc supply (PA volts) for all eight RF power modules. Each switching power supply module is rated for a nominal 2725 W and provides an output voltage between 18 V and 53 V (typically 40 V). The modules regulate the output voltage based on a serial control input from the controller module (A4), applied via the module control/interface PWBs. Alarms that are internal to the power supply module are applied to the controller module via a serial (RS485) interface. The modules also sense out-of-regulation on the ac input and dc output, and applies a Power Fail Warning signal to the module control/interface PWB. Both conditions cause the power supply to shut itself down, thus reducing the transmitter's RF output. All power supply module signals are applied to the controller for system level monitoring.

Control/Monitor Stage

See electrical schematic Figure SD-3 and SD-4. The control/monitor stage performs many critical functions for the transmitter. It:

- ❖ contains monitoring and protection circuits to prevent transmitter damage under adverse or fault conditions, including high speed SWR protection, high reject power protection and interlock/muting.
- ❖ monitors the current value of various parameters including cooling fan tachometer outputs, transmitter output forward and reflected power, module temperature, PA current levels, and PA power supply status signals.
- ❖ measures and monitors the output voltage from the power supply modules as well as the low voltage power supplies.
- ❖ generates the signals that enable the power supply modules and control their output voltage.
- ❖ provides the status of any controller fault conditions.
- ❖ contains an integral DSP that performs all audio processing including filtering and FM baseband modulation.
- ❖ interfaces with the RF and power supply sections of the transmitter to perform control and monitoring functions.
- ❖ provides local and remote interfacing for the transmitter. Local interfacing is performed via the front panel display (U1) - a 4 x 20 graphic LCD display - and its adjacent keypad. The UI contains a menu-based series of pages that serve specific functions. Similar interfacing, as well as more advanced functionality, is available on a remotely accessed AUI.

The primary components of the control/monitor stage are the exciter/controller PWB (A4A1), which is part of the controller (A4) and the module control/interface PWBs (A3 and A18).

The UI interface PWB (A2) provides an interface between the front panel display (U1) and the rack 1 module control/interface PWB (A3). It also contains the pushbutton switches (RF ON, RF OFF and LOCAL/REMOTE) and associated status LEDs that protrude through the front panel, below the UI.

An optional remote interface PWB (A16) provides a more convenient method to remotely control and monitor the transmitter, including a more accessible LAN port. It contains push-button switches that provide backup control for the RF on/off, local/remote, power increase/decrease, preset selection, enabling/disabling auto exciter changeover, active exciter selection and reset functions. It also contains LEDs that serve as an alternate means to monitor status (local/remote and RF on/off) and various status and alarm parameters.

RF Drive Stage

See electrical schematics Figure SD-5 (single exciter) or SD-6 (dual exciters). The RF drive stage converts the exciter's RF output to the intermediate RF level needed to drive the RF power modules. It consists of exciter A (A4), optional exciter B (A5), a coaxial relay (K1), 20 kW RF drive splitter assembly (A27), and 10 kW RF drive splitter assemblies (A7 and A19).

Exciter(s)

Exciter A (part of controller module A4) and B (A5, optional) are the RF drive sources for the transmitter. They accept the external audio program information (see the NV20LT/NV15LT Pre-installation Manual for details on various program input types). For dual exciter applications, the exciters' main/standby operation is controlled locally using the front panel UI, or remotely using the web-based AUI. The exciter outputs are applied to the RF drive splitter/changeover assembly (A27). The exciter provides a nominal RF drive signal of 260 W (in analog mode) at 98 MHz.

See also the Audio Path Block Diagram in [Figure 3.1.2 on page 3.1.12](#).

RF Drive Splitting/Changeover

See also electrical schematics Figure SD-33 and SD-38. Coaxial relay K1 controls the routing of the main exciter and, if applicable, the standby exciter and provides the RF drive signal for the 20 kW RF drive splitter assembly (A27), which is the first stage of RF drive splitting. A second stage of RF drive splitting is provided by 10 kW RF drive splitter assemblies (A7 and A19), which split the outputs of the 20 kW RF drive splitter into eight RF drive signals for the eight RF power modules.

Coaxial Relay Control - Dual Exciters Only

The RF drive outputs from exciters A and B are applied to the coaxial relay at K1-N/C and K1-N/O, respectively. The Exciter Relay Control input (K1-E1) is a signal applied from the control/monitor stage, via the reject load/splitter interface assembly (A28) that controls relay K1. The control/monitor stage provides a +15 V dc power supply on K1-E2.

- ❖ When exciter A is selected as the main RF drive source, the Exciter Relay Control input is open circuit. Coaxial relay K1 de-energizes and applies exciter A's RF drive signal to the 20 kW RF drive splitter.
- ❖ When exciter B is selected as the main RF drive source, the Exciter Relay Control input is near ground potential (0 V). Coaxial relay K1 energizes and applies exciter A's RF drive signal to the 20 kW RF drive splitter.

20 kW RF Drive Splitter

The 20 kW RF drive splitter (A27) contains a 3 dB hybrid coupler connected as a splitter. The RF drive source (A or B) selected by relay K1 is applied to A27's A2J4 input. The signal is split into two equal amplitude signals that are 90° out-of-phase. These split signals are applied to 10 kW RF drive splitter assemblies (A7 and A19). Cooling air is provided by splitter fan 1 (B1).

A sample of the 20 kW RF drive signal is applied to the control/monitor stage, via the reject load/splitter interface assembly (A28) for monitoring purposes.

10 kW RF Drive Splitters

The 10 kW RF drive splitters (A7 and A19) accept the outputs from the 20 kW RF drive splitter (A27) and splits each output into four equal amplitude signals, using three 3 dB couplers connected in a two-stage, binary splitting arrangement. The outputs of each of these splitters are applied to the eight RF power modules in the RF power stage. Attenuation values are set in order to balance the RF drive output levels.

RF Power Stage

See electrical schematics Figure SD-7 and SD-8. The RF power stage accepts the intermediate RF drive inputs from the RF drive stage and generates the final RF output. It consists of eight RF power modules, the module control/interface PWBs (A3 and A18), two 10 kW combiner/filters (A12 and A24), a 20 kW combiner (A25), output power probe (A15), 4-input reject load assembly (A29), 1-input reject load assembly (A13), reject load interface PWB (A14), reject load/splitter interface assembly (A28) and part of 20 kW RF drive splitter assembly (A27).

RF Power Module

See electrical schematic Figure SD-34. Each of the eight RF power modules provides up to 3000 W (for NV20LT) or 2250 W (for NV15LT) of RF output power. Each module contains four power amplifier (PA) PWBs (A1 through A4), a splitter/interface PWB (A5), combiner PWBs (A6 and A7), and six cooling fans. The intermediate RF drive outputs from the RF drive stage are applied to the RF power modules via the module control/interface PWBs. Within each RF power module, the RF drive signal is sampled and then split to drive the module's four PAs. The PA Volts inputs from the associated power supply modules control the RF output of the four PAs. The RF power module provides critical signals (RF drive sample, reject power sample, heatsink temperature, module presence and fan speeds) to the control/monitor stage for monitoring purposes.

Module Control/Interface PWBs

See also electrical schematics Figures SD-13 through SD-20. There are two module control/interface PWBs (A3 and A18). Each of them performs the following functions:

- ❖ interfaces with four RF power module's RF drive inputs.
- ❖ interfaces between the controller (A4) and the rest of the transmitter, distributing forward and reflected power samples, exciter control signals, and metering for reject load assemblies and the RF drive splitter assembly.
- ❖ distributes RF drive power, PA voltage and PA bias voltage to the RF power modules.
- ❖ monitors critical parameters of the RF power modules, such as RF drive sample, reject power sample, heatsink temperature and cooling fan speed. Monitoring circuits determine if a parameter is out of tolerance and generate the necessary control signal to compensate for the out of tolerance condition or to inhibit the RF power module's associated power supplies.
- ❖ applies control signals to the power supply modules from the controller and also monitors status signals and critical meters from the power supply modules and applies them to the controller. The controller can inhibit the power supply modules, as necessary (RF off), or enable the power supply modules (RF on).
- ❖ generates a sample of the PA voltage applied to each RF power module and applies it to the control/monitor stage.
- ❖ controls the reject load/splitter fan voltage (i.e., speed)

10 kW Combiner/Filters

Each of the two 10 kW combiner/filters (A12 and A24) is a 2-stage combiner that accepts the RF outputs from four RF power modules and uses three 3 dB hybrid couplers to provide a single RF output. The first two hybrid couplers are used in a pair of 5 kW combiners, which each accepts the outputs of two RF power modules. The equal amplitude, 90° out-of-phase (quadrature) RF signals are combined at the 3 dB hybrid coupler outputs and applied to a third and final, 10 kW 3 dB hybrid coupler. Again, the equal amplitude, quadrature RF signals are combined. The combined output is applied to a 10 kW low pass filter before being applied to the 20 kW combiner (A25).

Any amplitude or phase imbalances between 3 dB hybrid coupler inputs cause a proportional signal to be applied to the 4-input 5 kW reject load assembly (A29). The amplitude of the *5 kW Rej Ld Pwr* (1-2 through 7-8) (via J5 and J6 of each 10 kW combiner) represents imbalance between the combined outputs of the first stage of combining. The amplitude of the *10 kW Rej Ld Pwr* (1-4 signal (via J7 of each 10 kW combiner) represents imbalance between the combined outputs of the second stage of combining (differences in pairs of RF power modules).

20 kW Combiner

The 20 kW combiner (A25) accepts the RF outputs from the two 10 kW combiner/filters and uses a 3 dB hybrid coupler to provide a single, final RF output. The combined output is applied to the transmitter's RF output, via the output power probe (A15).

Any amplitude or phase imbalances between the 3 dB hybrid coupler inputs cause a proportional signal to be applied to the 1-input reject load assembly (A13). The amplitude of the *Final Rej Ld Pwr (1-8)* signal (via J1 of the 20 kW combiner) represents imbalance between the 20 kW combiner inputs.

4-Input Reject Load Assembly

The 4-input reject load assembly (A29) provides a means to dissipate reject power from the four *5kW Rej Ld Pwr* outputs of the 10 kW combiner/filters' 3 dB hybrid couplers. The 4-input reject load assembly contains power resistors to dissipate reject power. Cooling air for the 4-input reject load assembly is provided by fans B4 through B6. The control/monitor stage monitors the speed of the cooling fans and regulates the voltage being applied to them accordingly.

Reject power generated by the first (5 kW) combining stage of the 10 kW combiner/filters is dissipated by resistors in the 4-input reject load assembly. Micro-strip transmission lines (on 4-input reject load PWB A29A1) in close proximity to the reject load signals induce true RF sample voltages of the associated reject power. These samples are peak detected and applied to the control/monitor stage via the reject load/splitter interface assembly (A28). The reject load/splitter interface assembly provides an interface between the ac-dc power stage's Rej Fan Volts supply and the cooling fans. It also acts as the interface between the cooling fans' Rej Fan Tach signals and the control/monitor stage.

2-Input Reject Load (part of 20 kW RF Drive Splitter Assembly)

The 2-input reject load on the 20 kW RF drive splitter (A27) provides a means to dissipate reject power from the two *10kW Rej Ld Pwr* outputs of the 10 kW combiner/filters' 3 dB hybrid couplers. The 2-input reject load assembly contains power resistors to dissipate reject power. Cooling air for the 2-input reject load assembly is provided by fans B1, B2 and B3. The control/monitor stage monitors the speed of the cooling fans and regulates the voltage being applied to them accordingly.

Reject power generated by the second (10 kW) combining stage of the 10 kW combiner/filters is dissipated by resistors in the 2-input reject load assembly. Micro-strip transmission lines (on 2-input reject load PWB A27A1) in close proximity to the reject load signals induce true RF sample voltages of the associated reject power. These samples are peak detected and applied to the control/monitor stage via the reject load/splitter interface assembly (A28). The reject load/splitter interface assembly provides an interface between the ac-dc power stage's Rej Fan Volts supply and the cooling fans. It also acts as the interface between the cooling fans' Rej Fan Tach signals and the control/monitor stage.

1-Input Reject Load Assembly

The 1-input reject load assembly (A13) provides a means to dissipate reject power from the output of the 20 kW combiner's 3 dB hybrid coupler. The 1-input reject load assembly contains power resistors to dissipate reject power. Cooling air for the 1-input reject load assembly is provided by internal fans B1 and B2. The control/monitor stage monitors the speed of the cooling fans and regulates the voltage being applied to them accordingly.

Reject power generated by the 20 kW combiner/filter is dissipated by resistors in the 1-input reject load assembly. A micro-strip transmission line (on 2-input reject load PWB A13A1) in close proximity to the reject load signal induces a true RF sample voltage of the reject power. This sample is peak detected and applied to the control/monitor stage via the reject load interface PWB (A14). The reject load interface PWB provides an interface between the ac-dc power stage's Rej Fan Volts supply and the cooling fans. It also acts as the interface between the cooling fans' Rej Fan Tach signals and the control/monitor stage.

Output Power Probe

See electrical schematic Figure SD-36. The output power probe (A15) monitors the transmitter's forward and reflected power and generates the Fwd Pwr Sample (A1J1) and Refld Pwr Sample (A2J1) signals applied to the control/monitor stage for protection and monitoring. RF monitor PWB A3 provides a nominal 3.1 V (NV20LT) or 2.5 V (NV15LT) rms [at 20 kW (NV20LT) or 15 kW (NV15LT)] signal at A3J1, which is applied to the panel mount connector (W8J1) behind the front, hinged UI panel. This can be used with a modulation monitor or spectrum analyzer. RF sample PWBs A4 and A5 provide similar samples at A4J1 and A5J1. The sample at A4J1 is applied to exciter B (if used) for use by the remote AUI's spectrum analyzer display. The sample at A5J1 is not used in this configuration. Dc reflected power sample PWB A6 provides a dc voltage representative of the reflected power sample, for use by the control/monitor stage.

NV15LT / NV20LT BLOCK DIAGRAM

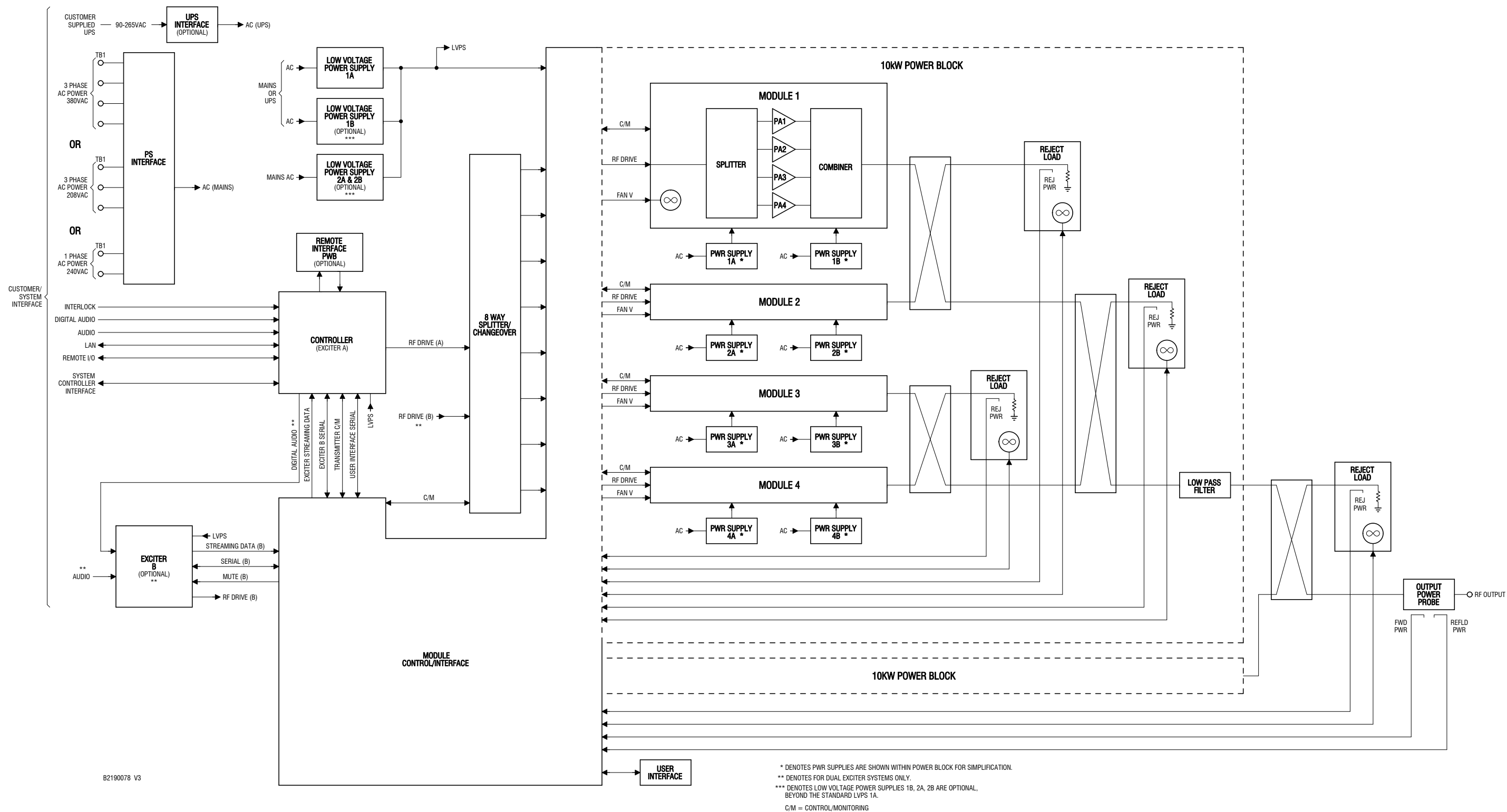

Figure 3.1.1: NV20LT/NV15LT Transmitter Block Diagram

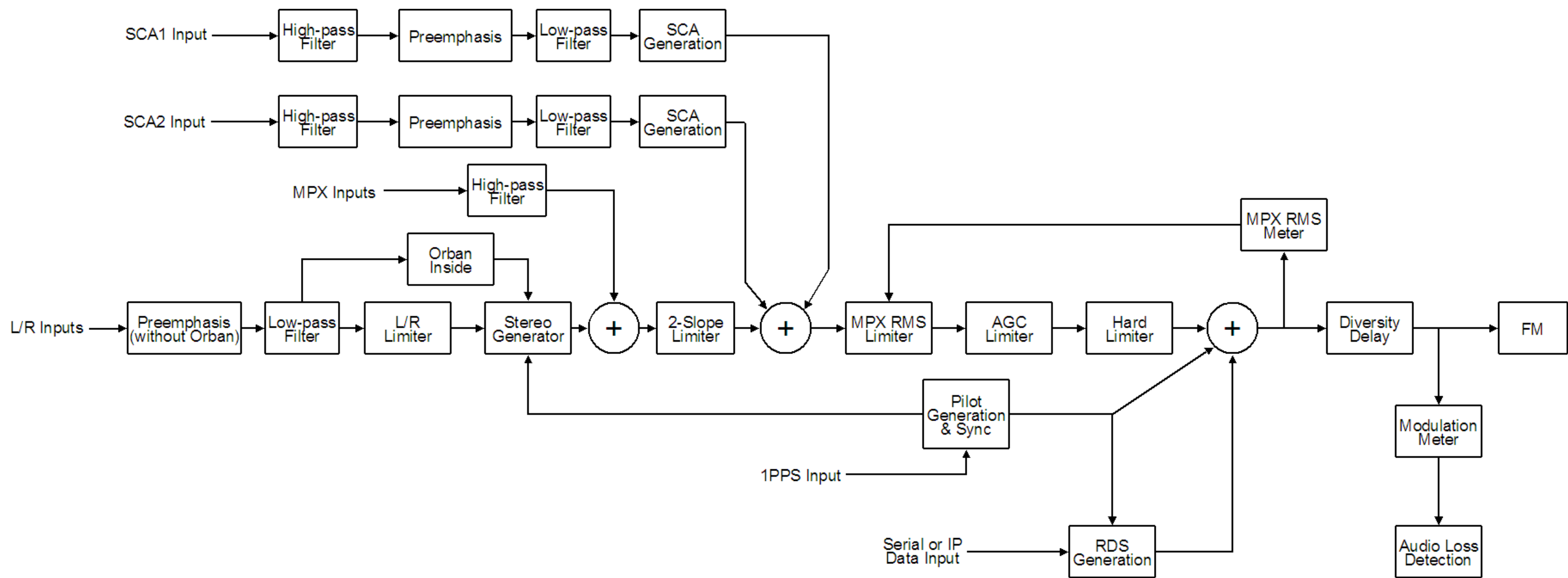

Figure 3.1.2: NV20LT/NV15LT Audio Path Block Diagram

SECTION 3.2: OPERATING THE TRANSMITTER

This section provides information about operating the NV20LT/NV15LT transmitter:

- [User Interface Options](#) - see page 3.2.4
 - [Front Panel UI](#) - see page 3.2.4
 - [Front Panel Pushbuttons](#) - see page 3.2.10
 - [Advanced User Interface \(AUI\)](#) - see page 3.2.16
- [Logging in to the AUI](#) - see page 3.2.19
- [Menu Page](#) - see page 3.2.22
- [Viewing Transmitter Log](#) - see page 3.2.24
 - [Transmitter Log - Using the AUI](#) - see page 3.2.24
 - [Transmitter Alarms and Log - Using the Front Panel](#) - see page 3.2.32
 - [Understanding the Log Manager Window](#) - see page 3.2.26
- [Viewing Tool Menu Panels](#) - see page 3.2.34
- [Viewing Real-Time Meters](#) - see page 3.2.46
 - [Viewing Real-Time Meters - using the AUI](#) - see page 3.2.46
 - [Viewing Real-Time Meters - Front Panel](#) - see page 3.2.51
- [Presets - Editing Operational Settings](#) - see page 3.2.54
 - [Managing Presets - Using the AUI](#) - see page 3.2.54
 - [Managing Presets - Using the Front Panel](#) - see page 3.2.73
 - [Preset Scheduler](#) - see page 3.2.170
- [Resetting Alarms](#) - see page 3.2.94
- [Viewing Transmitter Status - AUI](#) - see page 3.2.95

-
- User Settings - AUI - see page 3.2.97, User Settings - Front Panel UI - see page 3.2.121
 - Network Setup - see page 3.2.98
 - Email Configuration - see page 3.2.103
 - Notifications - see page 3.2.105
 - Nautel Phone Home - see page 3.2.107
 - SNMP Configuration - see page 3.2.108
 - Capturing Critical Parameters - see page 3.2.109
 - Using an External 10 MHz Input - see page 3.2.110
 - Setting the Clock - see page 3.2.112
 - Configuring NTP Servers - see page 3.2.115
 - Setting User Thresholds - using the AUI - see page 3.2.117
 - Setting User Thresholds - see page 3.2.117
 - Turn-On Behaviour - see page 3.2.120
 - User Accounts - see page 3.2.131
 - Setting User Permission Level - see page 3.2.132
 - Editing Account Information - see page 3.2.132
 - First-Time Login - see page 3.2.134
 - System Settings - using the AUI - see page 3.2.135
 - Reboot - see page 3.2.136
 - Upgrade Software - see page 3.2.137
 - Exciter TCXO - see page 3.2.138
 - Audio Input Calibration - see page 3.2.139
 - System Settings - using the Front Panel UI - see page 3.2.140
 - Host Reset - see page 3.2.141
 - OS Recovery - see page 3.2.141
 - Configuring Host Watchdog - see page 3.2.142
 - Updating Firmware - see page 3.2.142
 - Adjusting Display Settings - see page 3.2.143
 - Setting Exciter TCXO Offset - see page 3.2.145
 - Configuring Installed Hardware - see page 3.2.146
 - FM Polarity - see page 3.2.151
 - Adjusting Factory Settings - see page 3.2.152

- [Configuring Remote Inputs and Outputs - see page 3.2.156](#)
 - [Remote I/O Settings - Using the AUI - see page 3.2.156](#)
 - [Remote I/O Settings - Using the Front Panel Display - see page 3.2.162](#)
 - [Monitoring Analog Outputs - see page 3.2.165](#)
 - [Site Control Settings - see page 3.2.167](#)
- [Preset Scheduler - see page 3.2.170](#)
 - [Enabling the Scheduler - see page 3.2.172](#)
- [Audio Player - see page 3.2.173](#)
 - [Playlist - see page 3.2.174](#)
 - [Streams - see page 3.2.176](#)
- [Changing Exciter Transfer Settings - see page 3.2.179](#)
 - [Exciter Changeover Settings - Using the AUI - see page 3.2.179](#)
 - [Exciter Changeover Settings - Using the Front Panel - see page 3.2.180](#)
- [Enabling and Operating the Orban Audio Processor - see page 3.2.182](#)
 - [Configuring the Transmitter for the Orban Audio Processor - see page 3.2.183](#)
 - [Enabling the Orban Audio Processor for Preset Selection - see page 3.2.184](#)
 - [Selecting an Orban Audio Processor Preset - see page 3.2.187](#)
 - [Managing an Orban Audio Processor Preset - see page 3.2.189](#)

User Interface Options

The user can interface with the NV20LT/NV15LT using one of three methods:

- Locally, using the front panel display, its navigational buttons (see [Front Panel UI](#)) and the RF On, RF Off and Local/Remote control push-buttons (see [Front Panel Pushbuttons, on page 3.2.10](#)).
- Remotely, via a LAN connection, using the advanced user interface (AUI) pages (see [Advanced User Interface \(AUI\), on page 3.2.16](#)).
- Remotely, via remote input/output (I/O) wiring connected to the controller (A4) or the optional remote interface PWB (A16) (see the NV20LT/NV15LT Pre-installation Manual for I/O details).



NOTE:

It is recommended the browser history be cleared before viewing the remote AUI.

See the complete menu hierarchy illustrated in [Figure Figure 3.2.1](#) and [Figure Figure 3.2.2](#) (for the local front panel menu) and [Figure Figure 3.2.3](#) (for the remote AUI menu). When a user interfacing function can be performed from both the front panel display and the remote AUI, both are described in this section.

Front Panel UI

The front panel UI is 4 x 20 character graphic LCD display (see [Figure 3.2.5 on page 3.2.9](#)). The UI can be controlled by its adjacent keypad. The UI contains a menu-based series of pages that serve specific functions. Similar interfacing, as well as more advanced functionality, is available on the remotely accessed AUI (see [Front Panel UI Screens, on page 3.2.12](#)).

LCD Display

This display shows all the UI screens. The display's top level screen, used for viewing purposes only, is shown in [Figure 3.2.4 on page 3.2.9](#).

FRONT PANEL UI

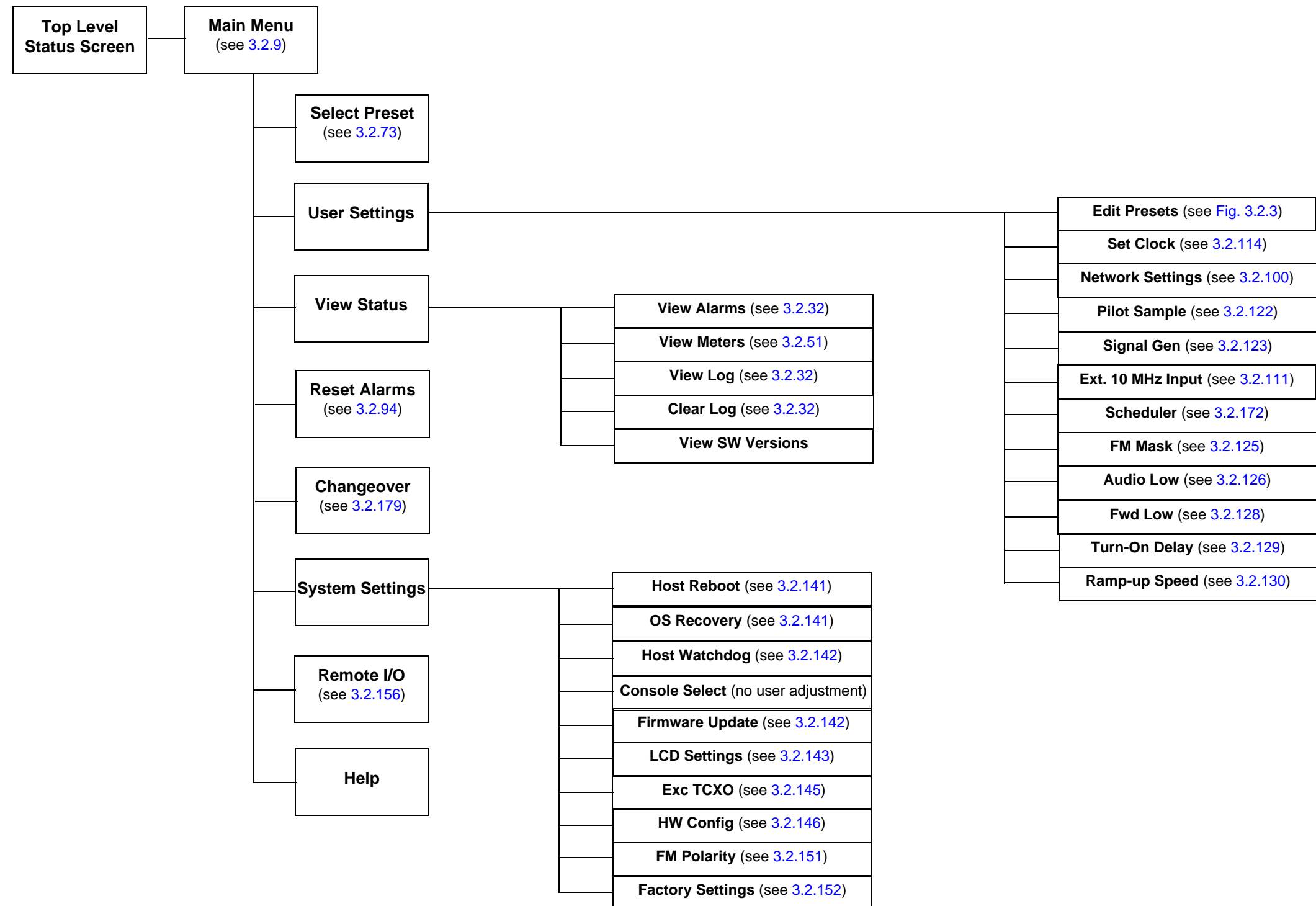

Figure 3.2.1: NVLT Transmitter Front Panel Display Menu Tree (Sheet 1 of 2)

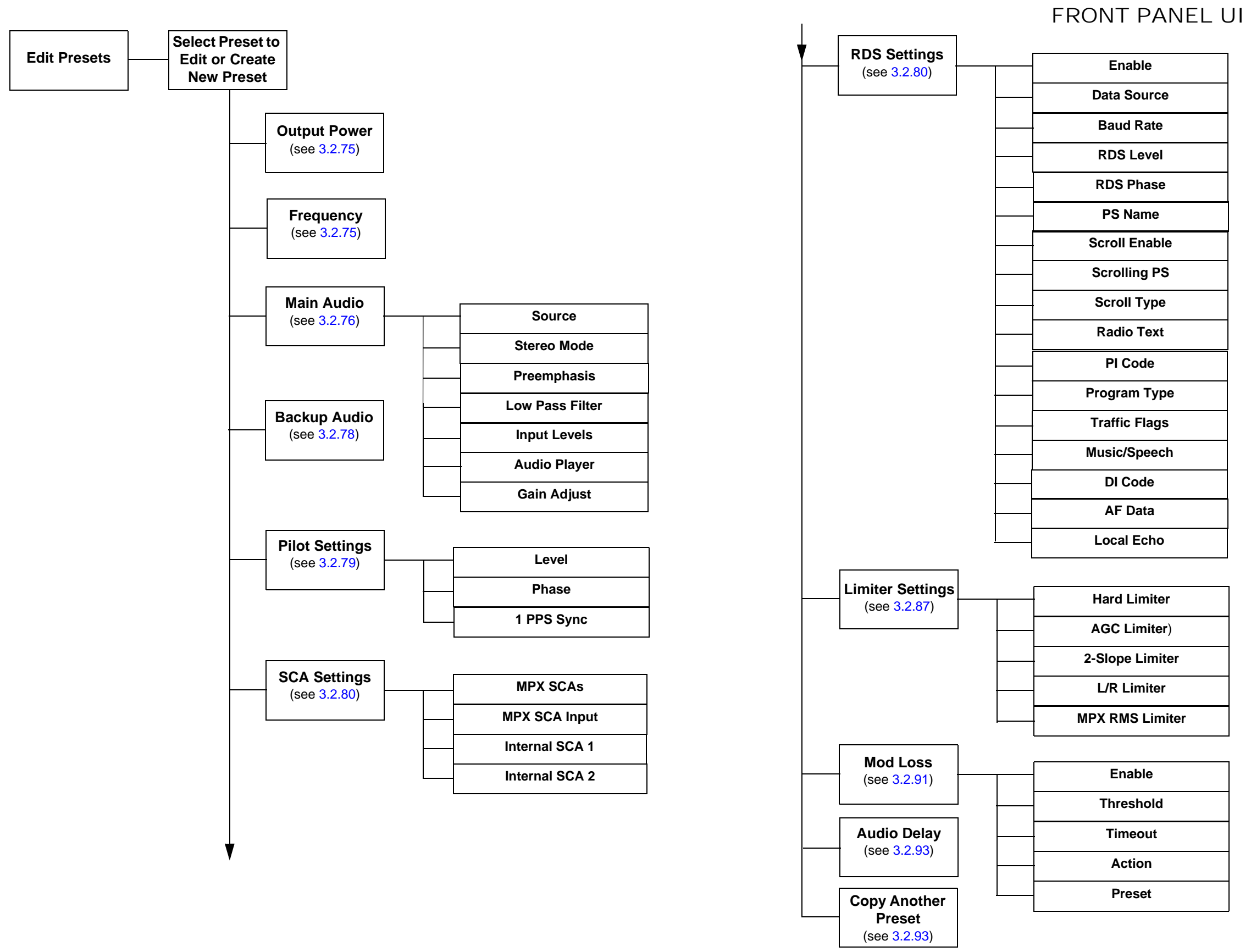

Figure 3.2.2: NVLT Transmitter Front Panel Display - Edit Presets Menu (Sheet 2 of 2)

Remote AUI

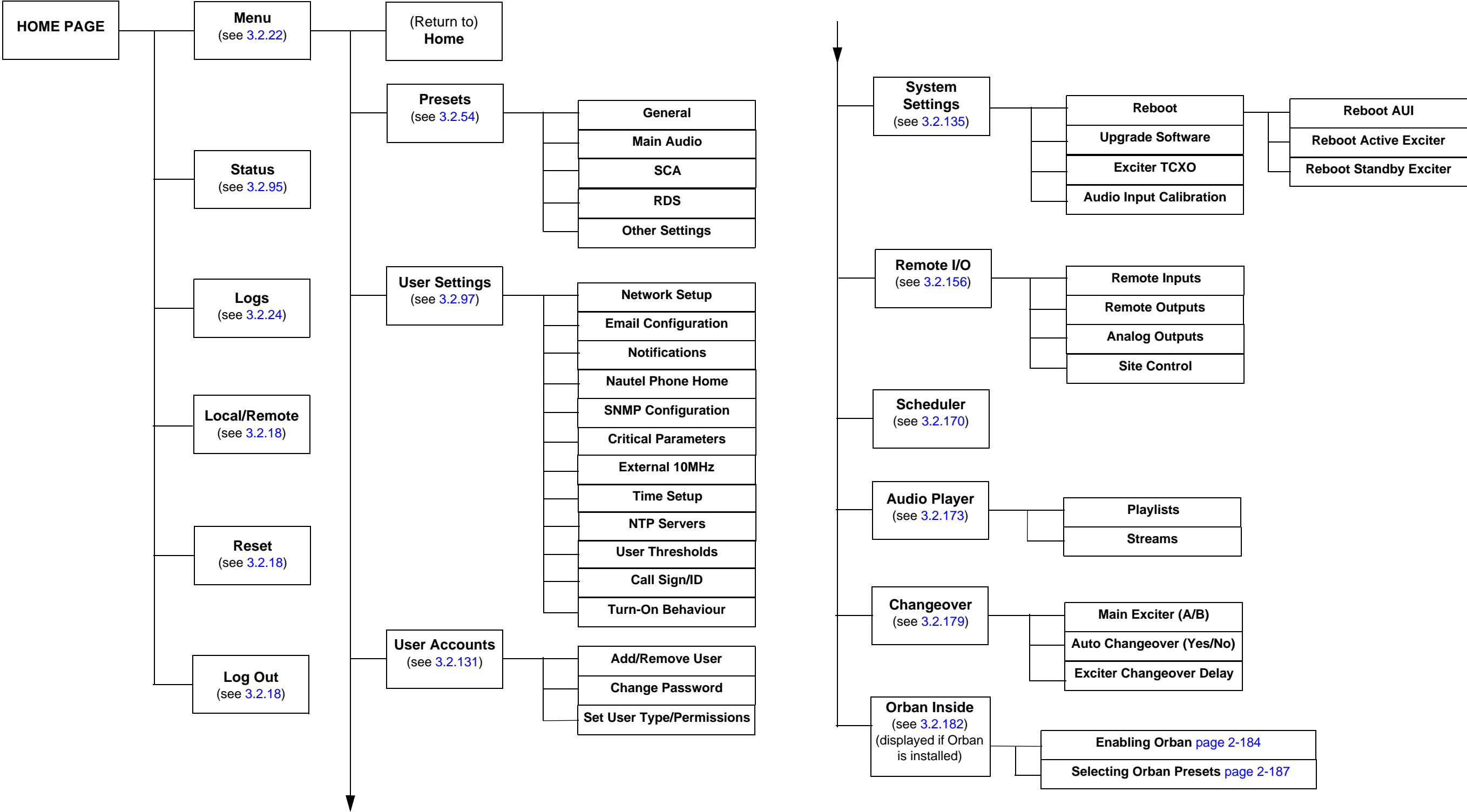
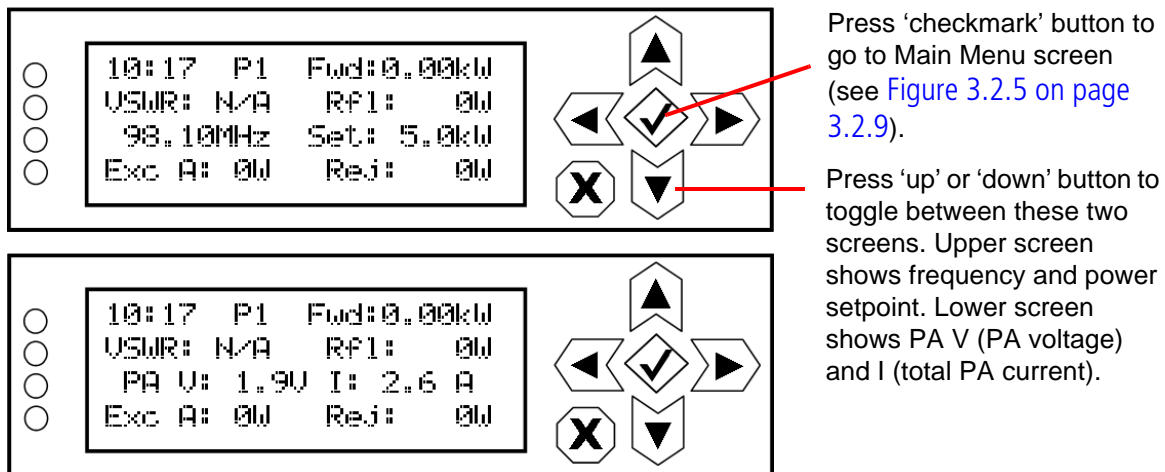

Figure 3.2.3: NVLT Transmitter AUI Flow Diagram

Figure 3.2.4: Top Level Screens



The top level screen displays the following information:

- ❖ Line 1: current time, active preset (e.g., P1) and the transmitter’s actual forward power.
- ❖ Line 2: VSWR ratio and the transmitter’s reflected power level.
- ❖ Line 3: operating frequency and the desired power set point (or PA voltage and total PA current).
- ❖ Line 4: active exciter’s forward power level and the total system reject power.

Main Menu

This main menu is the starting point for navigating through the UI screens. See [Table 3.2.1 on page 3.2.12](#) for a list of screens and their basic functions.

Figure 3.2.5: Main Menu

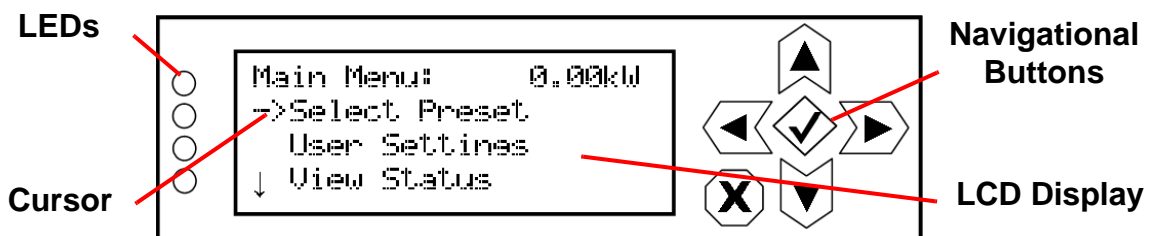

Navigational Buttons

There are six push-buttons on the right-hand side of the LCD display that allow navigation through the UI pages, as well as modifying selected settings.

- ❖ Up and down - on menu and list screens, moves cursor up and down through the associated page; on edit screens, increases and decreases the value of a parameter being modified.
- ❖ Left - on menu and list screens, exits to the next higher level screen; on edit screens, moves the editing cursor left, as applicable.
- ❖ Right - on menu and list screens, goes to the next lower level screen; on edit screens, moves the editing cursor right, as applicable.
- ❖ Checkmark - on menu screens, goes to the next lower level screen; on edit screens, acts as an "accept" or "save" function; in some cases the display will prompt its use.
- ❖ X - on menu and list screens, exits to the next higher level screen; on edit screens, acts as a "cancel" function; in some cases the display will prompt its use.

Saving Settings

Many of the UI screens allow for modifying a selected setting. Use the checkmark button to save a change. Use the X button to cancel a change and revert back to the previously stored value.

LEDs

There are four LEDs on the left-hand side of the LCD display that provide the operational status of various sections of the transmitter - Exciter, Power Amplifier, Output Network and Power Supply (see [Figure 3.2.5 on page 3.2.9](#)). The LEDs can glow green, amber or red. Typically, green indicates normal operation, amber indicates a warning, and red indicates a fault or error. Refer to the Troubleshooting section for more detailed information on LED status.

Front Panel Pushbuttons

The front panel contains three pushbutton switches that provide local control of the transmitter's RF on/off status and the local/remote operational control status (see [Figure 3.2.6](#)).

Figure 3.2.6: Front Panel Pushbutton Switches

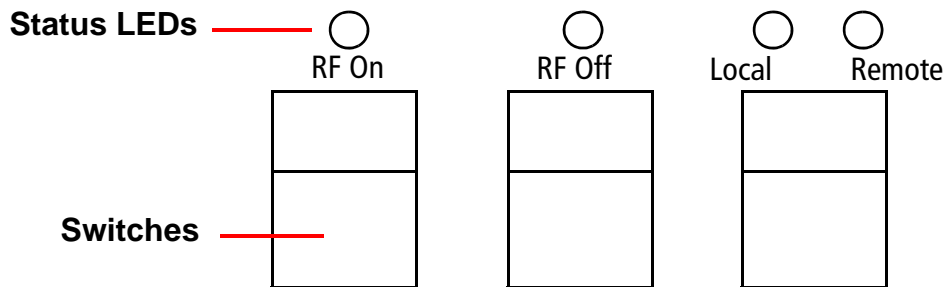

- ❖ RF On - In local mode, press the pushbutton switch to turn on the RF power stage and cooling fans. The RF On LED will be on (amber) when the RF power stage is on and the external interlock circuit is intact. The transmitter will operate at the level stored in the selected preset.
- ❖ RF Off - Regardless of the remote enable/disable status, press the pushbutton switch to turn off the RF power stage. The RF Off LED will be on (amber) when the RF power stage is off.

NOTE: The RF On and RF Off LEDs may blink if there are alarms occurring that prevent the transmitter from enabling the RF power stage (e.g., interlock open, combiner matching, etc.)

- ❖ Local/Remote - Press the switch to toggle between "remote enabled" (Remote amber LED on; local and remote control) and "remote disabled" (Remote LED off; local control only). The transmitter's local controls are always enabled. In Local mode (Local amber LED on), the front panel switches and UI control transmitter operation and all of the remote controls (except the external interlock) are disabled. In Remote mode, control of transmitter functions is also provided to the remote (web-accessed) AUI or remote input/output control via the rear of the controller module or the optional remote interface PWB. The bottom of the remote AUI home page will display the control status. When remote control is enabled, both the Local and Remote buttons are green. When remote control is disabled, only the Local button is green.

Front Panel UI Screens

Table 3.2.1 defines the available front panel display screens.

Table 3.2.1: Front Panel UI Screens

UI Screen	Function	See Page
Main Menu	Choose options and navigate to other screens.	page 3.2.9
Select Preset	Select and activate a user-defined preset.	page 3.2.73
User Settings	Edit various transmitter user settings (see other User Settings options in this table).	-
User Settings - Edit Presets	Edit various parameters for a user-defined preset (see the following rows for all Edit Presets options).	page 3.2.73
User Settings - Edit Presets - Output Power	Edit the selected preset's output power.	page 3.2.75
User Settings - Edit Presets - Frequency	Edit the selected preset's operating frequency.	page 3.2.75
User Settings - Edit Presets - Main Audio	Edit the selected preset's main audio characteristics such as source, stereo mode, pre-emphasis and low pass filtering.	page 3.2.76
User Settings - Edit Presets - Backup Audio	Enable and edit the selected preset's backup audio characteristics such as source, stereo mode, pre-emphasis and low pass filtering.	page 3.2.78
User Settings - Edit Presets - Pilot Settings	Edit the selected preset's pilot settings such as level, phase and 1 PPS synchronization.	page 3.2.79
User Settings - Edit Presets - SCA Settings	Edit the selected preset's SCA settings such as SCA reduction, MPX SCAs, MPX SCA input and internal SCA (1 and 2) generator characteristics.	page 3.2.80
User Settings - Edit Presets - RDS Settings	Edit the selected preset's RDS settings such as enable/disable, data source, baud rate, level, phase, program type, alternate frequency data, etc.	page 3.2.82
User Settings - Edit Presets - Limiter Settings	Edit the selected preset's limiter settings. Limiter types include hard limiter, AGC limiter, 2-slope limiter, L/R limiter and MPX RMS limiter.	page 3.2.87
User Settings - Edit Presets - Mod Loss	Edit the selected preset's modulation loss functionality, such as enable/disable, setting threshold, setting timeout period, setting resulting action and selecting a backup preset.	page 3.2.91
User Settings - Edit Presets - Audio Delay	Edit the selected preset's audio delay.	page 3.2.93

Table 3.2.1: Front Panel UI Screens

UI Screen	Function	See Page
User Settings - Edit Presets - Copy Another Preset	Copy the selected preset's settings to another preset.	page 3.2.93
User Settings - Set Clock	Set precise time and date.	page 3.2.114
User Settings - Network Settings	View and/or set network information such as MAC address (view only), DHCP on/off status, IP address, netmask and gateway.	page 3.2.100
User Settings - Pilot Sample	Set the pilot sample level for the controller's rear panel BNC connector.	page 3.2.122
User Settings - Signal Gen	Enable/disable and setup the internal signal generator.	page 3.2.123
User Settings - Ext. 10 MHz Inp	Enable/disable the use of an external 10 MHz signal.	page 3.2.111
User Settings - Scheduler	Enable/disable the scheduler.	page 3.2.172
User Settings - FM Mask	Select the FM mask - FCC, ETSI or None (turns off mask).	page 3.2.125
User Settings - Audio Low	Set the low audio thresholds and associated timeout delays.	page 3.2.126
User Settings - Fwd Low	Select the low and very low forward power thresholds.	page 3.2.128
User Settings - Turn-On Delay	Set the transmitter turn-on delay period.	page 3.2.129
User Settings - Ramp-Up Speed	Set the transmitter's ramp-up speed.	page 3.2.130
View Status	View various transmitter parameters (see other View Status options in this table).	-
View Status - View Alarms	View all active transmitter alarms.	page 3.2.32
View Status - View Meters	View the levels of various transmitter parameters, including forward power, reflected power, PA voltage, PA current and low level dc supply voltages.	page 3.2.51
View Status - View Log	View the transmitter's events log, including alarms, commands, etc.	page 3.2.32
View Status - Clear Log	Clear the transmitter's events log.	page 3.2.32
View Status - View SW Versions	View the versions of software installed on the transmitter.	-
Reset Alarms	Initiate an attempt to reset all alarms controlled by latched protection circuits.	page 3.2.94

Table 3.2.1: Front Panel UI Screens

UI Screen	Function	See Page
Changeover	For dual exciters, controls the auto exciter transfer function. You can also enable the standby exciter test function (local control only).	page 3.2.180
System Settings	Edit various transmitter system settings (see other System Settings options in this table).	-
System Settings - Host Reset	Initiate a reset of the exciter/control PWB's host processor.	page 3.2.141
System Settings - OS Recovery	Initiate a recovery reset of the operating system in the event of a failed software upgrade.	page 3.2.141
System Settings - Host Watchdog	Enable, disable or force a reset of the host watchdog feature.	page 3.2.142
System Settings - Console Select	Factory set; no user adjustments required.	-
System Settings - Firmware Update	Perform a software upgrade on the transmitter.	page 3.2.142
System Settings - LCD Settings	Set the front panel display's contrast, backlight and timeout.	page 3.2.143
System Settings - Exciter TCXO	Calibrate the internal clock to a user supplied external high precision 10 MHz clock reference	page 3.2.145
System Settings - HW Config	Configure various system hardware parameters (see other System Settings - HW Config options in this table).	page 3.2.146
System Settings - HW Config - Installed Exc	Configures the transmitter for single or dual exciter installation.	page 3.2.147
System Settings - HW Config - LVPS Hardware	Configures the transmitter for single or redundant LVPS installation.	page 3.2.148
System Settings - HW Config - LVPS Voltage	Set the normal-state voltage of the low voltage power supply.	page 3.2.148
System Settings - HW Config - Fan Speed	Set the normal-state speed of the transmitter's cooling fans.	page 3.2.149
System Settings - HW Config - UPS Installed	Set the transmitter for UPS operation.	page 3.2.150
System Settings - HW Config - Audio Processor	Set audio processor to none or Orban Inside.	page 3.2.185

Table 3.2.1: Front Panel UI Screens

UI Screen	Function	See Page
System Settings - FM Polarity	Set the polarity for FM deviation; positive modulation signal yields positive frequency deviation or negative modulating signal yields positive frequency deviation.	page 3.2.151
System Settings - Factory Settings	Sets critical thresholds, calibration values and operating values for key transmitter parameters. These settings are established at the factory and do not normally require user adjustment (see other System Settings - Factory Settings options in this table).	page 3.2.152
System Settings - Factory Settings - Thresholds	Set protection thresholds for various parameters (e.g., SWR shutback, high/low exciter PA power, low/very low forward power, etc.).	page 3.2.153
System Settings - Factory Settings - Calibration	Set calibration values or run calibration routines for various parameters (e.g., forward/reflected power, program input levels, etc.).	page 3.2.154
System Settings - Factory Settings - Exciter PA Power	Set the normal operating power level for the active exciter, in FM mode.	page 3.2.155
Remote I/O	Configure the remote inputs, remote outputs and analog outputs for the transmitter.	page 3.2.156

Advanced User Interface (AUI)

The NV20LT/NV15LT's advanced user interface (AUI) (see [Figure 3.2.7 on page 3.2.17](#)) is available via remote connection only. To access the AUI, you need a PC (and a web browser) that is connected to the NV20LT/NV15LT - directly or through a switch or network - via the controller module's (A4) rear panel LAN connection (A1J8A) or the optional remote interface PWB's (A16) LAN connection (J1). The AUI has a wide range of displays, including:

- ❖ Tool menu panels (spectrum analyzer, Lissajous plot, etc.)
- ❖ Real-time meters
- ❖ Detailed transmitter status and events log
- ❖ Presets
- ❖ User Settings
- ❖ User Accounts
- ❖ System Settings
- ❖ Remote Input/Output Configuration
- ❖ Scheduler
- ❖ Audio Player
- ❖ Changeover (as applicable)
- ❖ Orban Audio Processor (optional)

Each AUI page provides information about a specific transmitter function. All navigation through the AUI pages begins on the main screen (or Home page), shown in [Figure 3.2.7 on page 3.2.17](#).

Access the AUI's login page by entering the IP/port #. Any remote user with login access can view the transmitter's AUI pages; however, only users with the appropriate permission level can access functions that alter the transmitter control settings.

To log out of the AUI, or to login as another user, access the login menu by pressing the Log Out button on the Home page.

Figure 3.2.7: Using the AUI (Home page shown)

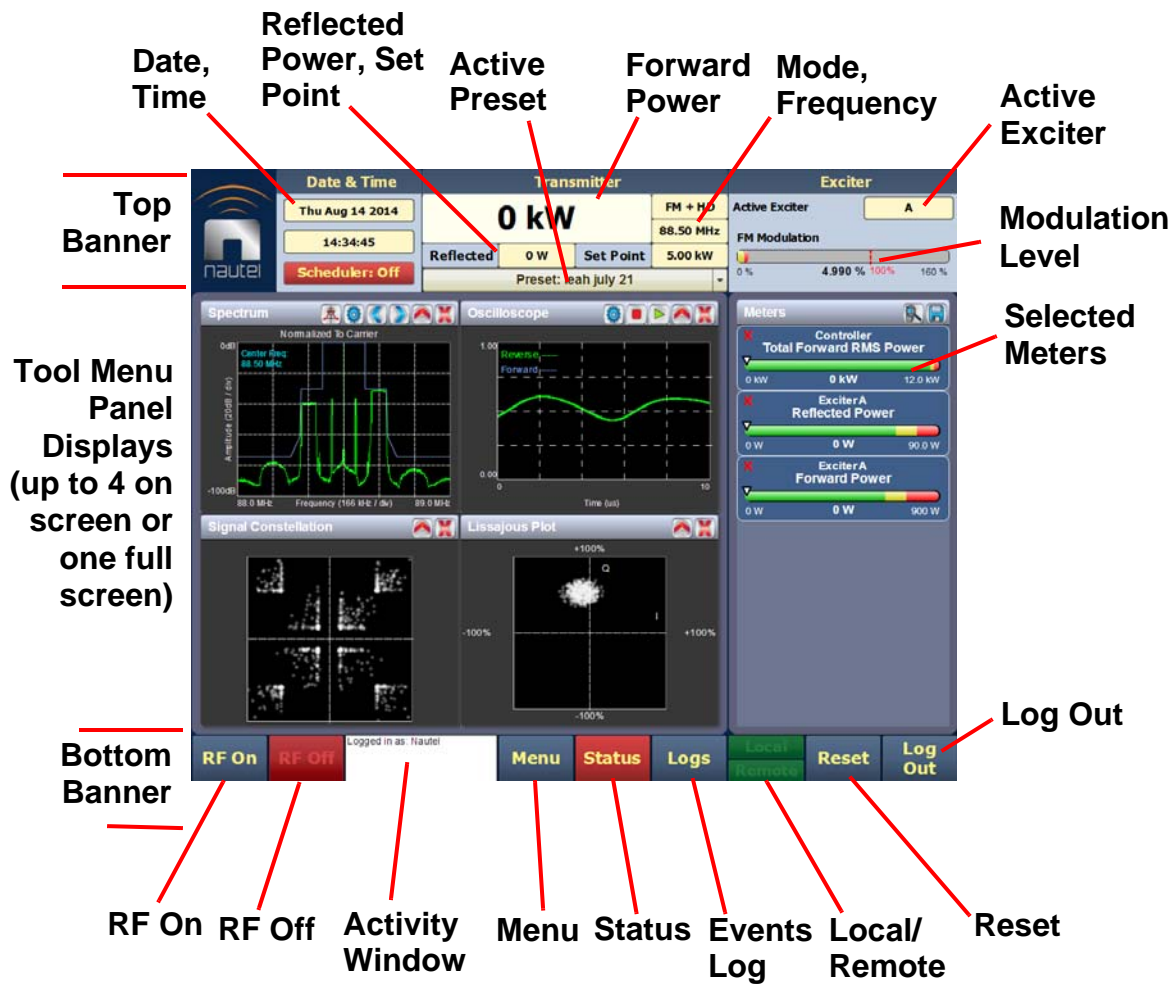

The top banner is permanent on all AUI pages and includes:

- Nautel Logo: From any AUI page, click the Nautel logo to log out and return to the login window.
- Date & Time: Displays day, month, year and current time (see [Setting the Clock, on page 3.2.112](#)).
- Active Preset: Displays the name of the active preset, power set point based on the active preset, current forward and reflected power levels, as well as the operating mode and carrier frequency.
- Active Exciter: Displays the active exciter (A or optional B) and the FM modulation, with rms (yellow) and peak (red) values. Click on the Active Exciter area to shortcut to the Changeover page (see [Changing Exciter Transfer Settings, on page 3.2.179](#)).

The bottom banner is also permanent on all AUI pages and includes:

- RF On: Click to enable the transmitter's RF power stage.
- RF Off: Click to disable the transmitter's RF power stage.
- Activity Window: Displays various messages to reflect specific user interface commands, such as RF on/off, local/remote control, or reset.
- Menu: Click to open the Menu page, which allows navigation to various other pages (see [Menu Page on page 3.2.22](#)).
- Status: Click to shortcut to the Transmitter Status page (see [Viewing Transmitter Status - AUI on page 3.2.95](#)), which provides current alarm and status details for the transmitter. When the Status button is red, one or more alarms of "high" severity is currently being reported and the transmitter is in an 'off-air' state. When the Status button is amber, "medium" or yellow "low" one or more lower level alarms is currently being reported, but the transmitter is still 'on-air', possibly at reduced power. When the Status button is green, the transmitter is operating normally. In this case there are no alarms being reported. This page is also available through the Menu page.
- Logs: Click to shortcut to the Transmitter Log page, which displays historical alarm and status records for the transmitter (see [Viewing Transmitter Log on page 3.2.24](#)).
- Local/Remote: Displays the operational control status of the transmitter. From the touch screen, press the desired button. If Local is highlighted green, only local control of the AUI is possible. If both Local and Remote are highlighted green, both local and remote controls are enabled.
- Reset: Press to reset protection circuits and restore any RF power modules (and associated power supplies) that were inhibited, but are now alarm-free. Resets protection circuits that have latched off the transmitter. To initiate an alarm reset from the front panel display, see [Resetting Alarms, on page 3.2.94](#).
- Log Out: Click to log out of the AUI session and return to the login menu. To log in again, use your remote PC's keyboard to enter your Username and Password, then click the Submit button. If you do not have a user account, see [User Accounts, on page 3.2.131](#).

The displays between the top and bottom menus, contains user selected pages. These pages provide access to a variety of AUI functions such as transmitter status and hardware settings. The following paragraphs describe how to use these pages.

Logging in to the AUI

The transmitter’s remote AUI provides a means to restrict access to transmitter control functions to authorized users only. There are four different user accounts that can be pre-defined to set access restriction between view only (no control) and full-administrative control (see “User Accounts” on page 3.2.131).

Access the AUI using a web browser as follows:

1. Configure your network settings (“Network Setup” on page 3.2.98).
2. On your router or firewall software, open ports 3501 and 80 and close (restrict access to) port 22. If you are using RDS data, open port 7005. If you are using SNMP, open port 161.
3. Gain remote access to the transmitter by entering the IP address in a web browser’s address field. Your login remains active until the browser is closed.
4. When properly configured, the login menu (see Figure 3.2.8) appears on the web browser. Your IP address and any login messages appear in a box at the top, beside the logo, and the current software version number appears along the bottom of the login window.

If the login menu does not appear, there may be an issue related to your web browser or plug-ins.

Figure 3.2.8: AUI Login Menu

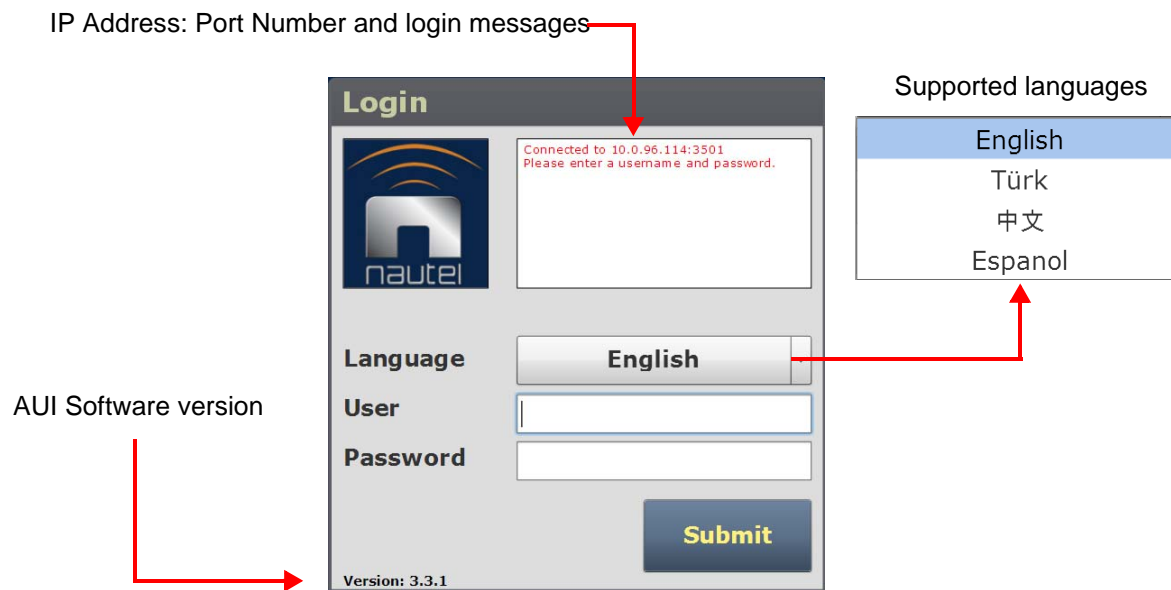

-
5. Log in to the AUI by entering the appropriate parameters in the login window.
 - In **Language** field, click the down-arrow to review a drop-down menu displaying the available language options, and select one.
 - In the **User** field, enter the username. Default is "Nautel".
 - In the **Password** field, enter the password. Default is blank.

NOTE:

The Nautel AUI is factory configured with a default login username and password. Nautel recommends that you change the password to improve overall system security (see "Changing the Password" on page 3.2.133).

- Click **Submit** to accept your login parameters and display the AUI home page ([Figure 3.2.7 on page 3.2.17](#)). Note: The opening screen (the **Home** page) will have the layout from the previous login session.

NOTE: If you do not have a user account, it must be set up by an existing user with proper permissions. See ["Removing an Account" on page 3.2.134](#)

AUI pages

Table 3.2.2 defines the available AUI pages.

Table 3.2.2: AUI Pages

AUI Page	Function	See Page
Home	View meters, tool menu panels, choose options and navigate to other pages.	page 3.2.17
Menu	Choose options and navigate to other pages.	page 3.2.22
Status	View transmitter’s current active faults and operational status.	page 3.2.95
Logs	View and analyze transmitter historical events.	page 3.2.24
Tool Menu	Choose tool menu panel options.	page 3.2.34
Meters	Choose meters for display.	page 3.2.46
Menu - Presets	Activate and edit user-defined presets.	page 3.2.54
Menu - User Settings	Set network information, configure email and alarm notification parameters, configure Nautel Phone Home feature, configure SNMP parameters, capture transmitter critical parameters, configure the use of an external 10 MHz source, set the system clock and manage NTP servers.	page 3.2.98
Menu - User Accounts	Set user permission rights and define user account information.	page 3.2.131
Menu - System Settings	Perform AUI and exciter reboots, calibrate the exciter TCXO, perform software upgrades and calibrate audio inputs levels, if necessary (factory calibrated).	page 3.2.135
Menu - Remote I/O	Define remote inputs/outputs and configure analog outputs.	page 3.2.156
Menu - Scheduler	Define a preset schedule for daily/monthly operation.	page 3.2.170
Menu - Audio Player	Manage audio playlists and stream sources.	page 3.2.173
Menu - Changeover	For dual exciter installations only. Set the main exciter, enable automatic changeovers and set the changeover delay period.	page 3.2.179
Menu - Audio Processor (if audio processor is installed)	Configure the transmitter for use with the Orban Inside option, if applicable. Icon displays only if Orban Inside is installed.	page 3.2.186

Menu Page

From the home page, click the Menu button to view the Menu page (see [Figure 3.2.9](#)). From this page, you can select one of the following sub-menus:

Figure 3.2.9: Menu Page

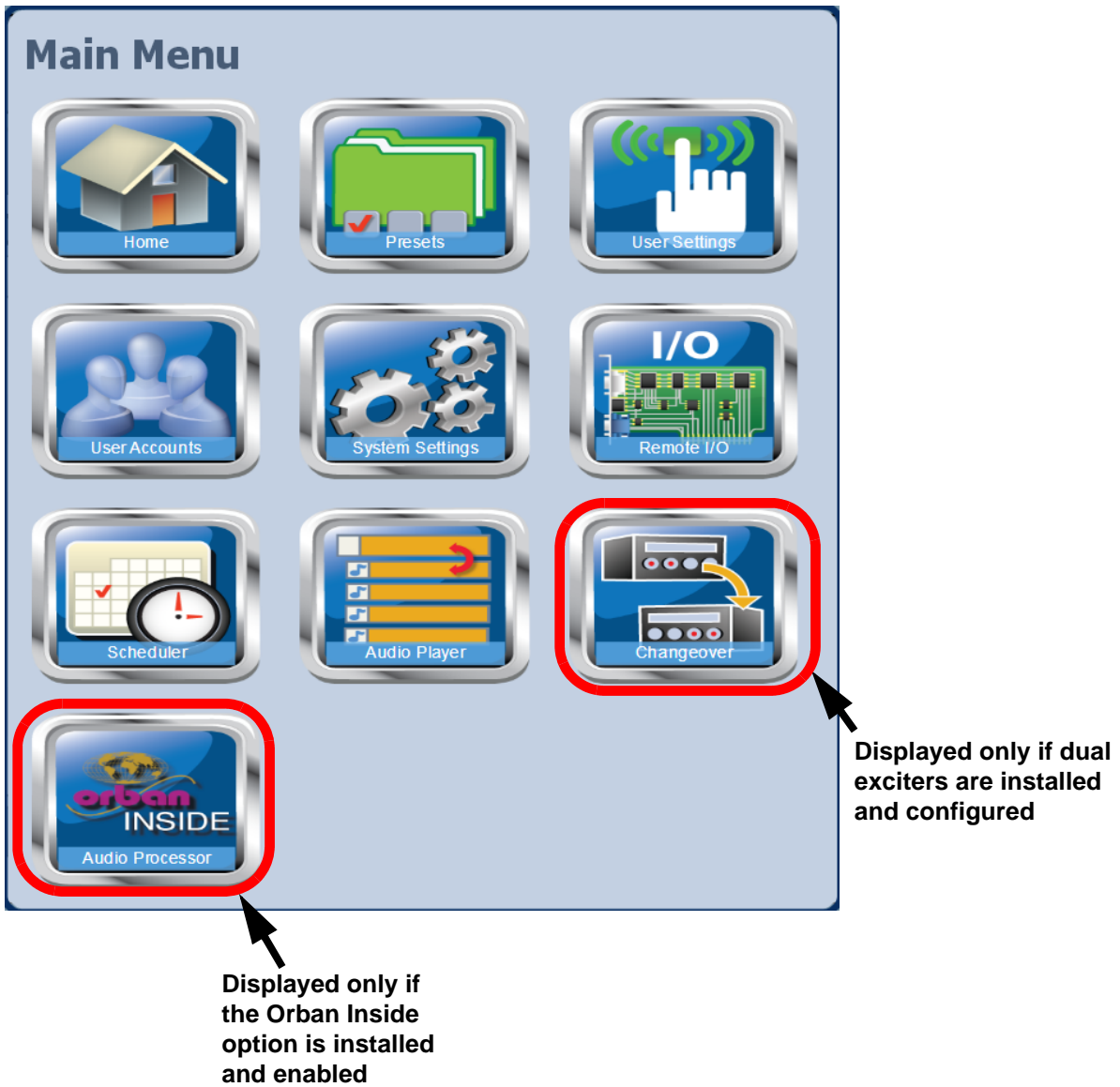

- ❖ Select Home to return to the Home page (see [Figure 3.2.7](#) on page 3.2.17).
- ❖ Select Presets to load, edit, or save presets (see [Presets - Editing Operational Settings](#), on page 3.2.54).
- ❖ Select User Settings to access a page that provides options for network configuration, email configuration, alarm notifications, Nautel Phone configuration, SNMP configuration, capturing critical transmitter data, using and external 10 MHz source, setting the system date and time, and configuring NTP servers (see [User Settings - AUI](#), on page 3.2.97).
- ❖ Select User Accounts to access a page that displays a list of users with access to the AUI. Depending on the user's permission level, allows editing of user accounts (see [User Accounts](#), on page 3.2.131).
- ❖ Select System Settings to access pages that allow rebooting of the AUI or active exciter, calibration of the exciter TCXO, upgrading of software files and calibration of audio inputs (see [System Settings](#), on page 3.2.135).
- ❖ Select Remote I/O to access a page that allows assignment of remote inputs, remote outputs, analog outputs and site control parameters (see [Configuring Remote Inputs and Outputs](#), on page 3.2.156).
- ❖ Select Scheduler to access a page that allows setting of daily preset schedules (see [Preset Scheduler](#), on page 3.2.170).
- ❖ Select Audio Player to access a page that allows managing of program playlists and streams (see [Audio Player](#), on page 3.2.173).
- ❖ Select Changeover to access a page that allows setting of the main exciter (if applicable), the status of the automatic exciter changeover feature and its associated changeover delay (see [Changing Exciter Transfer Settings](#), on page 3.2.179).
- ❖ Select Audio Processor, if the Orban Inside card has been installed and enabled, to access pages that allow creation and management of Orban audio processor presets (see [Enabling and Operating the Orban Audio Processor](#), on page 3.2.182).

Viewing Transmitter Log

You can view transmitter log information using the remote AUI (see [Transmitter Log - Using the AUI](#)) or using the local front panel display (see [Transmitter Alarms and Log - Using the Front Panel](#), on page 3.2.32).

Transmitter Log - Using the AUI

You can view the NV20LT/NV15LT's events log using the AUI's [Log page](#) - see [Figure 3.2.10](#). This page shows a configurable log of all transmitter events. To view the [Log page](#), click the Log button in the bottom banner of any AUI screen.

Figure 3.2.10: Log page

Date & Time
 Mon Jul 29 2013
 11:26:02
 Scheduler: Off

Transmitter
 0 kW
 Reflected: 1.00 W Set Point: 5.00 kW
 Preset: Preset 1

Exciter
 Active Exciter: A
 FM Modulation: 9.00 % (0% to 160% scale)

Transmitter Log

Log Manager
 353 Matches Sorted by Time of Event
 Page 1/4

Device	Event	State	Severity	Time of Event
Exciter A	Modulation Loss	⚠	⚠	Mon Jul 29 2013 11:25:25 610ms
Exciter A	MPX Audio Low	⚠	⚠	Mon Jul 29 2013 11:25:11 730ms
Exciter A	Analog Right Audio Low	✅	⚠	Mon Jul 29 2013 11:25:11 730ms
Exciter A	Analog Left Audio Low	✅	⚠	Mon Jul 29 2013 11:25:11 730ms
Exciter A	Modulation Loss	✅	⚠	Mon Jul 29 2013 11:25:11 730ms
Controller	Active Preset Index	4	⚠	Mon Jul 29 2013 11:25:11 710ms
Exciter A	Modulation Loss	⚠	⚠	Mon Jul 29 2013 11:25:11 630ms
Exciter A	MPX Audio Low	✅	⚠	Mon Jul 29 2013 11:24:53 130ms
Exciter A	Analog Right Audio Low	⚠	⚠	Mon Jul 29 2013 11:24:53 130ms
Exciter A	Analog Left Audio Low	⚠	⚠	Mon Jul 29 2013 11:24:53 130ms
Exciter A	Modulation Loss	✅	⚠	Mon Jul 29 2013 11:24:53 130ms
Controller	Active Preset Index	1	⚠	Mon Jul 29 2013 11:24:53 110ms

Navigation arrows on the right:
 ⏪ first page
 ⏴ page-by-page
 ⏴ row-by-row
 ⏴ row-by-row
 ⏵ page-by-page
 ⏩ last page

Bottom banner: RF On, RF Off, Menu, Status, **Logs**, Local Remote, Reset, Log Out

Viewing Event Logs

The Logs page displays a “read only” chronological table of log events under the following column headings (see [Figure 3.2.10](#)):

- Device - identifies the origin device of the alarm (e.g., Controller, Exciter, or RF Module).
- Event - identifies the alarm name.
- State - indicates whether the alarm state is active (red bell) or cleared (green checkmark) and in some cases, indicates whether the RF was turned on or off. This column will also display which control state (Local or Remote) the transmitter is in, which preset index was selected, the frequency that is set and the power level.
- Severity - indicates how seriously the alarm affects transmitter operation (see [Figure 3.2.11](#)).
- Time of Event indicates the time and date that the event occurred.

Figure 3.2.11: Alarm Severity Legend



= low (RF output not affected)



= medium (RF output may be reduced)



= high (RF output may be inhibited)

To navigate through the table, press the arrow keys on the right-side of the screen or use the scroll bar that appears when more than one page is available.

The table of log information can span over more than one page. The current page number is identified above the table on the right-side of the screen. When there are more than 100 matches in the list, a Page #/# tab will appear to allow viewing of further listings. For example, Page 1/4 means that the displayed page is one out of a possible 4 pages. Press the Page button to reveal information about the pages. The number of log matches displayed is shown below the Log Manager button (e.g., 353 Matches Sorted by Time of Event).

You can access a more detailed listing of events and resolve any alarm issues via the Log Manager window. Pressing the Log Manager button on the Logs page will provide access to this window (see [Figure 3.2.12 on page 3.2.26](#)).

Refer to the NV20LT/NV15LT Troubleshooting Manual to cross-reference the alarm name to possible causes and troubleshooting tips.

Understanding the Log Manager Window

The Log Manager window contains the functions that edit the logs listed in the Logs page. Press the Log Manager button to open a configurable window with the following display options identified by tabs across the top of the screen (see [Figure 3.2.12](#)):

- Filter Logs: Press to determine filter parameters by date and frequency.
- Copy Logs: Press to copy the selected logs (remote view only).
- Delete: Press to remove all selected logged events.
- Statistics: Press to display detailed information about an event(s).
- Legend: The Legend tab opens a "read only" display of alarm symbols to help you interpret the ones listed in the Logs page or in the Statistics window (see [Figure 3.2.16](#) on page 3.2.30).

Each of these tabs, opens a secondary window or changes the active window options to suit the tab function.

Figure 3.2.12: Log Manager Window

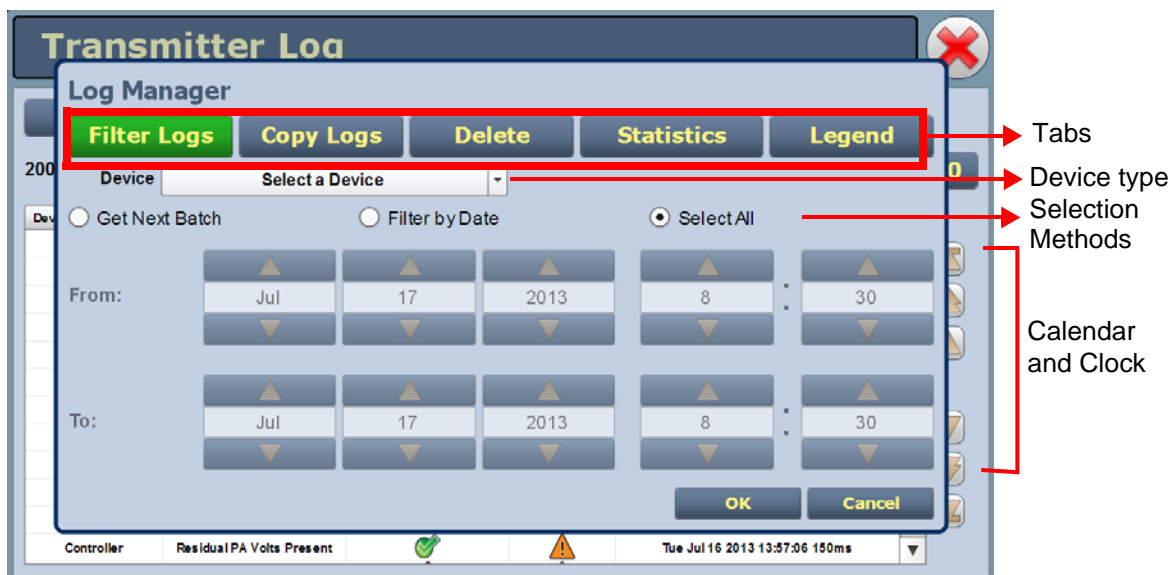

Filtering Logs

You can filter transmitter events based on their origin or date by pressing the Filter Logs button in the Log Manager (see Figure 3.2.13 on page 3.2.27).

Press the Select a Device drop-down arrow, and select the desired device type to filter events based on the type selected. Press the OK button or the Cancel button when done.

- ❖ No selection - displays all transmitter events (shown as Select a Device)
- ❖ Controller - displays controller events only
- ❖ Exciter A or B - displays applicable exciter events only
- ❖ Rack # - displays applicable Rack # events only
- ❖ RF Module # - displays applicable RF Module # events only

Activate a log mode option by selecting the adjacent radio button:

- ❖ Get Next Batch - allows users to see log events in batches of 2000
- ❖ Filter by Date - activates the calendar portion of the screen and allows users to select a date range
- ❖ Select All - selects all logs for display

Click the Cancel button to close this window and discard changes.

Figure 3.2.13: Log Manager - Filter Logs

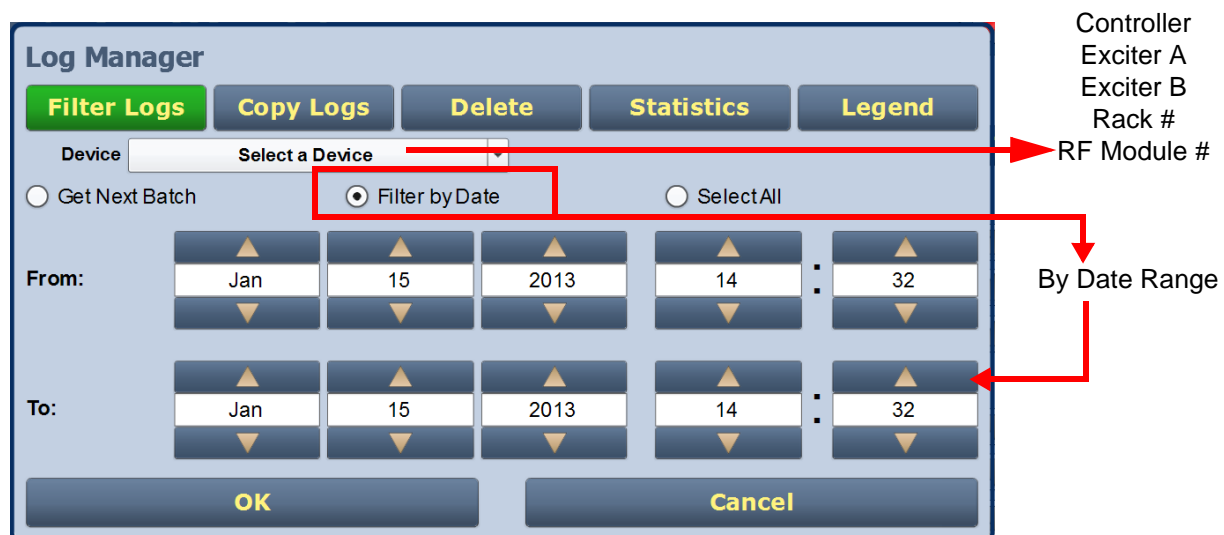

Copying Logs

Using the remote AUI only, you can create a copy of all the logs in the selected list (copied to the remote user's computer clipboard) by pressing the Copy Logs button in the Log Manager (see [Figure 3.2.14](#)). You can paste the tab-delimited text copy of the logs into a text editing program such as Word, Excel, Notepad, etc. Press OK or Cancel to close this window and return to the Transmitter Log.

Figure 3.2.14: Log Manager - Copy Logs

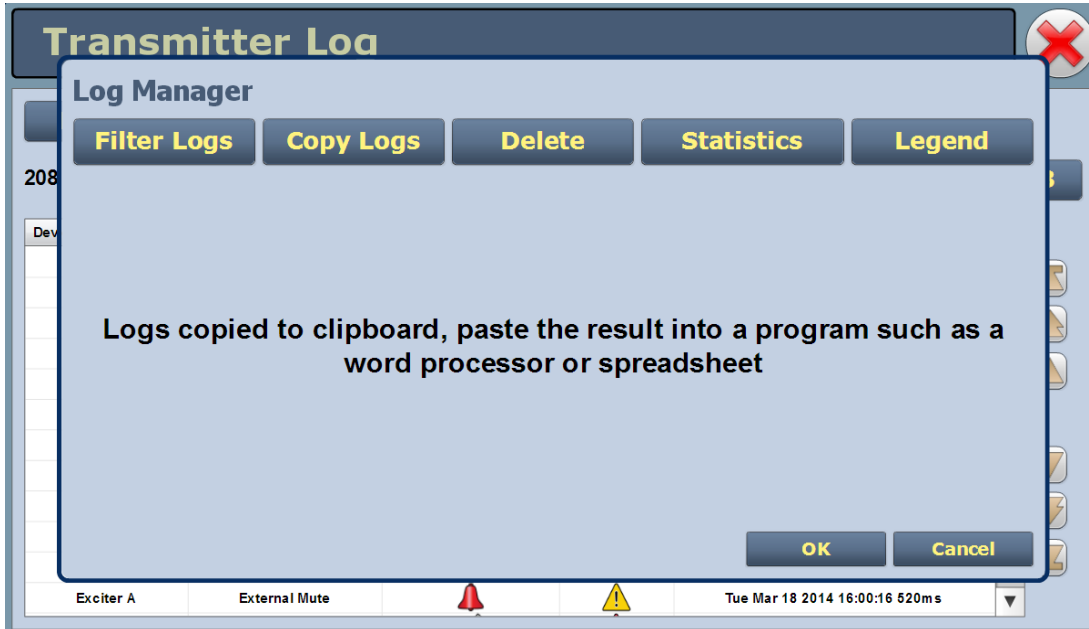

Deleting Logs

You can delete all events or a selection of events by pressing the Delete button in the Log Manager (see [Figure 3.2.15](#)).

- Delete by date - activates the calendar and clock (24-hour clock) where users can press the arrows to establish a date and time. Log events older than this date will be removed from the events list.
- Delete All - removes all the logs in the list.
- Press OK to accept the configuration or press Cancel button to close this window and return to the Transmitter Log.

Note:
Clearing the front panel UI's logs does not clear the logs displayed in the remote AUI.

Figure 3.2.15: Log Manager - Delete Logs

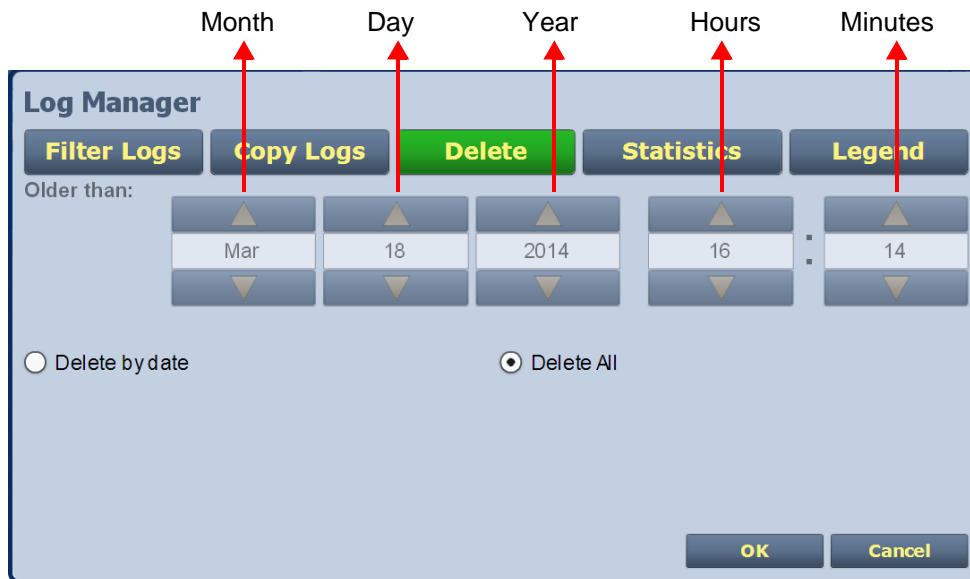

Viewing Log Statistics

You can view statistical information on the events being displayed by pressing the Statistics button in the log manager (see [Figure 3.2.16](#)).

NOTE: Only events subject to the filtering parameters are displayed on the Statistics screen.

The Statistics screen displays the events that occurred within the filtered period as well as the time and date of the earliest and latest event occurrence for each. You can move through the list using the scroll bar (if applicable) or the up and down arrow buttons to the right of the scroll bar. Press OK or Cancel to close this window. The columns in the display indicate specific information about the events:

- Device - refers to the device (Controller, Exciter, Rack, RF Module) associated with the alarm.
- Event - describes the alarm (e.g., Local/Remote switch)
- Severity - identifies the seriousness of the alarm (see [Viewing the Legend](#), on page 3.2.31).
- # Events - reveals the number of occurrences for that event during the filtered period.
- Earliest - refers to the first time of an alarm event, within the filtered period.
- Latest - refers to the latest time of an alarm event, within the filtered period. If an alarm has only one occurrence (i.e., # Events column is 1), then the time in the "Earliest" column will be the same as the time in the "Latest" column. If an alarm has more than one occurrence (e.g., # Events column is 4), then the "Earliest" column reveals the time of the first alarm (back in time), while the "Latest" column reveals the time of the last alarm (closest to the present).

Figure 3.2.16: Log Manager - Statistics

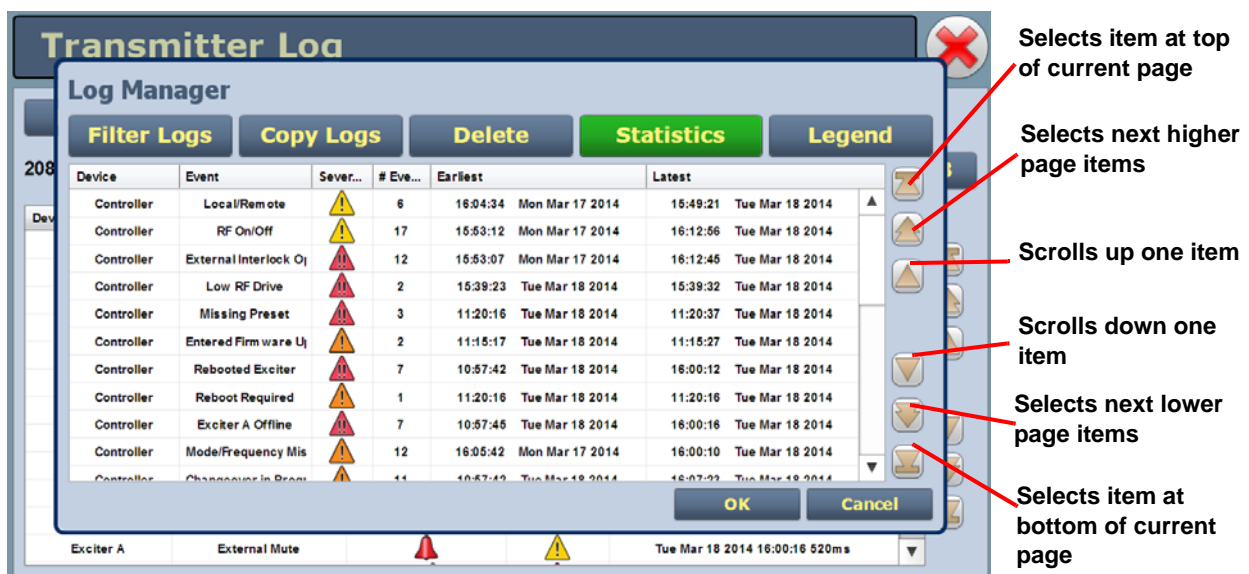

Viewing the Legend

Press the Legend button in the Log Manager (see [Figure 3.2.17](#)) to display a legend that describes the symbols shown in the State and Severity columns of the Logs page. Press OK or Cancel to close this window and return to the Transmitter Log page.

Figure 3.2.17: Log Manager - Legend



Transmitter Alarms and Log - Using the Front Panel

When you select View Status -> View Alarms or View Status -> View Log from the Main Menu (see [Figure 3.2.18](#)), you can view various active or logged events, respectively, of the NV20LT/NV15LT. These parameters are likely displayed on multiple pages and require that you scroll to view all of them.

NOTE: This screen is for viewing purposes only and does not offer the same level of analytical features as the AUI's Logs page (see [Figure 3.2.10](#) on page 3.2.24).

Figure 3.2.18: View Alarms and View Logs Screens

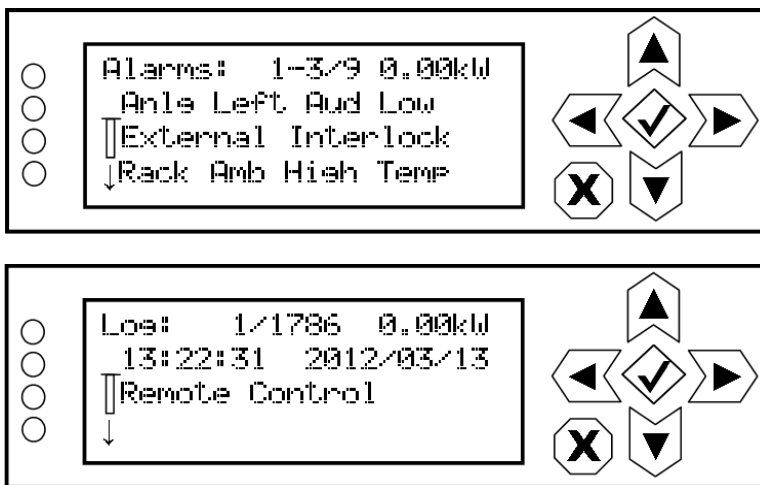

The View Alarms screen displays only alarms that are currently active. Older alarms that have cleared may still be present in the View Log screen.

Use the up and down buttons to scroll through the list of alarms or logged events.

Refer to the NV20LT/NV15LT Troubleshooting Manual to cross-reference the alarm name to possible causes and troubleshooting tips.

When you select Clear Log from the View Status menu, you will delete all logged events.

Note:
 Clearing the front panel UI's logs does not clear the logs displayed in the remote AUI.

Use the Reset Alarms command in the front panel UI's Main Menu -> Reset Alarms screen to attempt to clear any latching alarms that are holding the transmitter in an "off-air" state. If the offending alarm has cleared, the transmitter should resume operation. See [Resetting Alarms, on page 3.2.94](#).

Viewing Tool Menu Panels

The NV20LT/NV15LT AUI provides up to seven tool menu panels (depending on purchased options) that you can choose to display on the AUI home page. Up to four tool menu panels can be displayed at one time, including a spectrum analyzer. To view all the tool menu options (see [Figure 3.2.19](#)), close one of the existing tool menu panels on the Home page by clicking X in the top, right corner of the tool menu panel, and then click anywhere in the blank space. This section include the following topics:

- Describing Instrument Panel Options, on page 3.2.35
- Viewing Instrument Panels, on page 3.2.36
- Instrument Panel Procedures, on page 3.2.36
- Available Instrument Panels, on page 3.2.38

Figure 3.2.19: Tool Menus on Home page

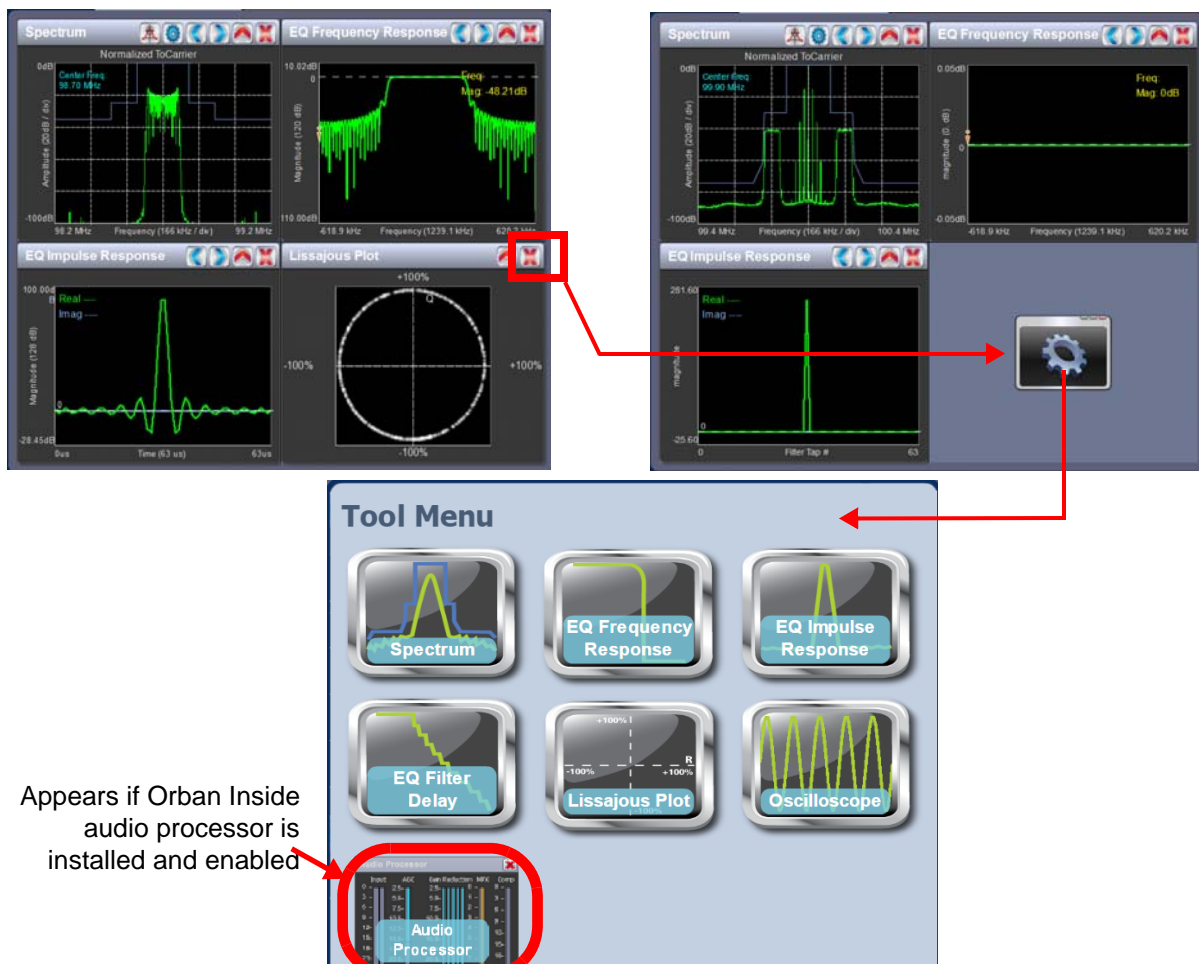

Click on the desired tool menu panel to display it. See [Table 3.2.3 on page 3.2.35](#) for a description of each tool menu panel.

Describing Instrument Panel Options

[Table 3.2.3](#) describes instrument panel options:

Table 3.2.3: Tool Menu Panels

TOOL MENU	DESCRIPTION	REFERENCE
Spectrum	Displays a spectrum analyzer, capable of monitoring the transmitter’s RF output and various RF sections of the exciter or an audio spectrum analyzer that displays the composite baseband signal.	See page 3.2.39
EQ Frequency Response	Displays the frequency response of the modulator’s EQ filter.	See page 3.2.40
EQ Impulse Response	Displays the impulse response of the modulator’s EQ filter.	See page 3.2.41
EQ Filter Delay	Displays the delay of the modulator’s EQ filter across its bandwidth	See page 3.2.42
Lissajous Plot	Displays a Lissajous figure that represents the relationship between the two applicable channels (either L and R or I and Q).	See page 3.2.43
Oscilloscope	Displays an oscilloscope, capable of monitoring various audio inputs and the precorrection forward/reverse signal.	See page 3.2.44
Audio Processor (optional)	Appears only when Orban Inside audio processor is installed and enabled. Displays various audio processor meters that indicate levels for inputs, AGC, gain reduction, multiplex (MPX) power and composite. Refer to Enabling and Operating the Orban Audio Processor on page 3.2.182 and the Orban Optimod 5500 manual for detailed information on these meters.	See page 3.2.191

Viewing Instrument Panels

Each instrument panel has a menu bar that may be different from other panels (see [Figure 3.2.20](#)).

Figure 3.2.20: Instrument Panel Menus

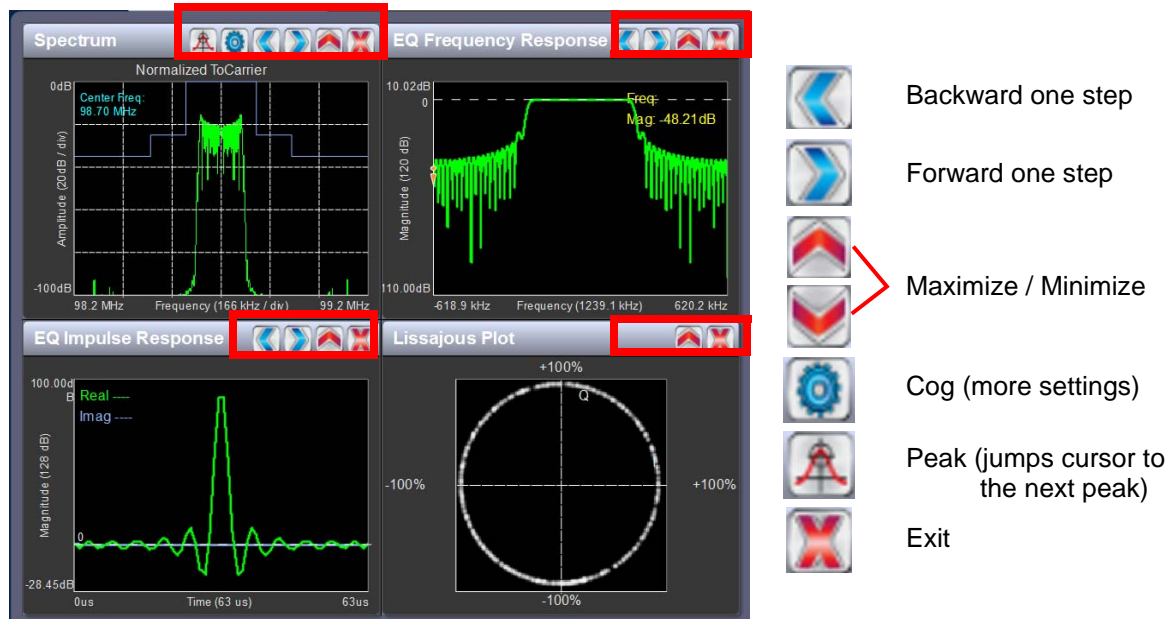

Each panel has a tool bar at the top of the display

Instrument Panel Procedures

Procedure to view instrument readings on the panel:

- To display a cursor in the panel, touch the screen where you want the cursor (see [Figure 3.2.21](#) on [page 3.2.37](#)). The cursor position is noted in the upper, right-hand corner of the panel (e.g., frequency and amplitude for the spectrum analyzer). Touch in other areas of the instrument to provide a coarse adjustment of the cursor position.
- To make fine adjustments, use the backward and forward buttons (see [Figure 3.2.20](#)).
- To enlarge/reduce the instrument panel, use the maximize/minimize buttons. Some instrument displays show more information when maximized (e.g., EQ Impulse Response (see [Figure 3.2.22](#) on [page 3.2.37](#)).
- To display additional settings in the Spectrum Analyzer panel, touch the “cog” button (see [Figure 3.2.20](#)). Displays include resolution bandwidth, span, averaging rate and the actual measurement source (transmitter output, audio analyzer, etc.) that is being displayed. Touch the “peak” button (see [Figure 3.2.20](#)) to place the cursor on the next successive peak in the spectrum.

Figure 3.2.21: Instrument Cursor Manipulation

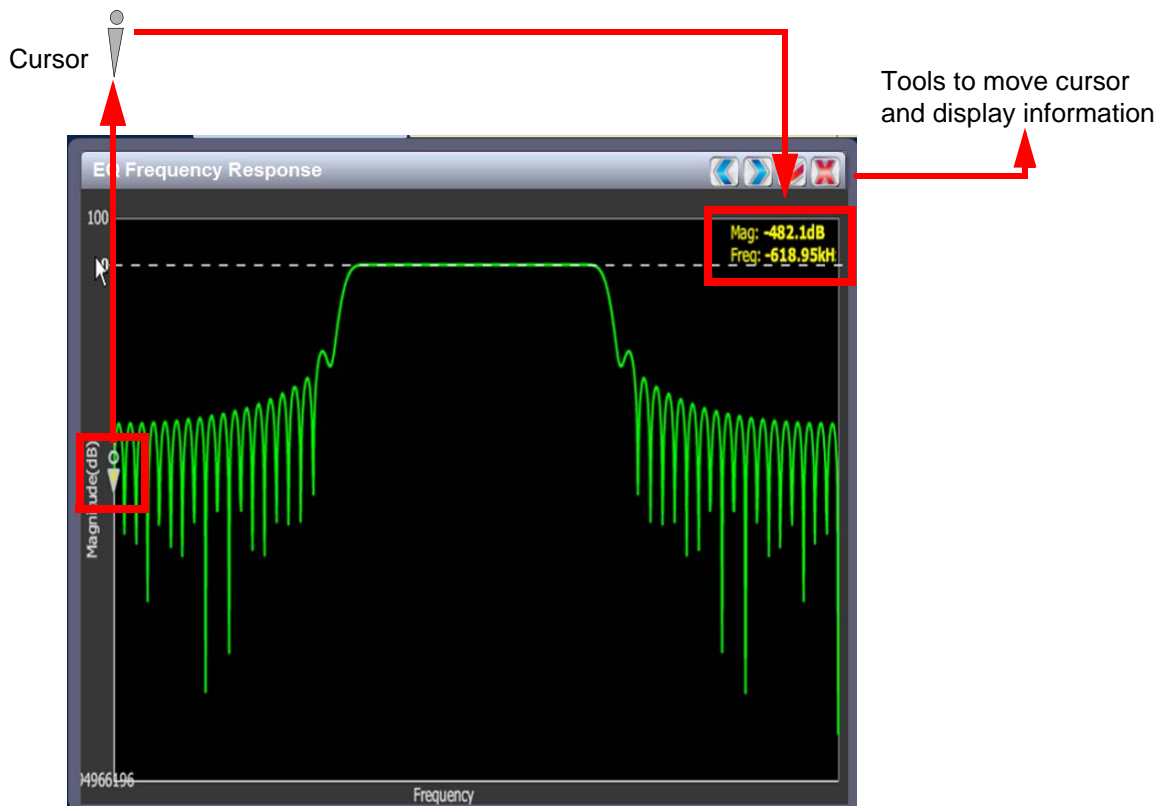
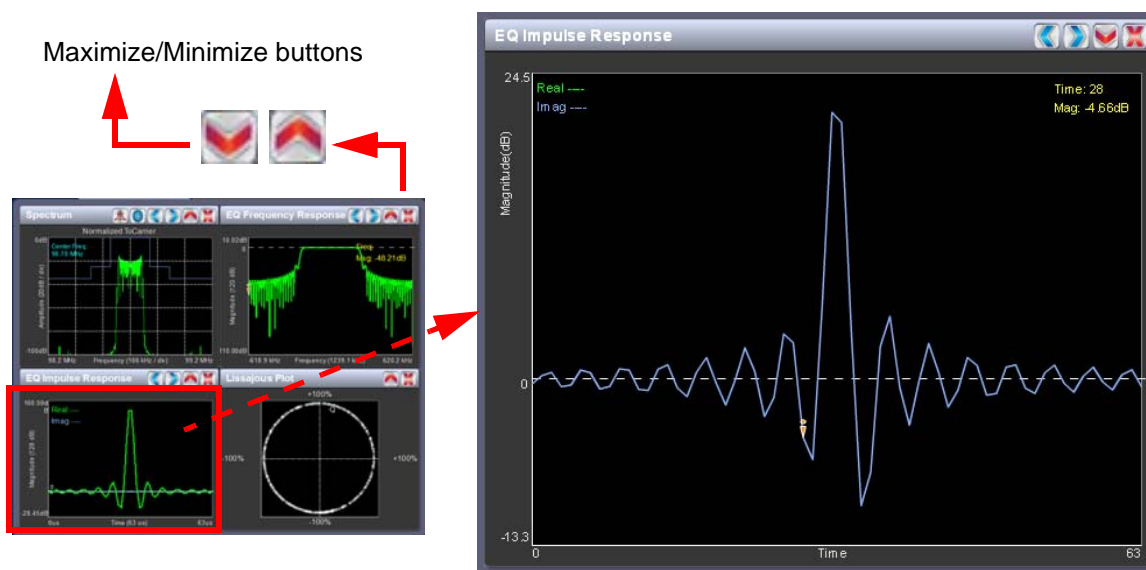

Figure 3.2.22: Instrument Panel - Expansion Example



Available Instrument Panels

Spectrum Analyzer

See [Figure 3.2.23](#). The carrier level is normalized to its unmodulated carrier level at 0 dB. The graph center is always at the carrier frequency, as defined by the active preset's Frequency value.

Masks are shown based on transmission mode and are defined by the latest versions of the following standards:

- IBOC: NRSC-5
- European Standard: ETSI EN 302 018-2
- FCC CFR 47, Part 73.317 and IC BETS-6e

NOTE: While very accurate, the spectrum analyzer may display artifacts (spurs) at some operating carrier frequencies that are a function of the analyzer and are not actually present on the output of the transmitter. If these spurious emissions are observed on the spectrum analyzer, Nautel recommends that a calibrated, external spectrum analyzer be used to verify the presence of spurs.

Touch on the panel to display a cursor in the approximate area. The cursor position (frequency and amplitude) is noted in the upper, right-hand corner of the panel. Touch other areas of this instrument panel to provide a coarse adjustment of the cursor position.

Figure 3.2.23: Spectrum Analyzer

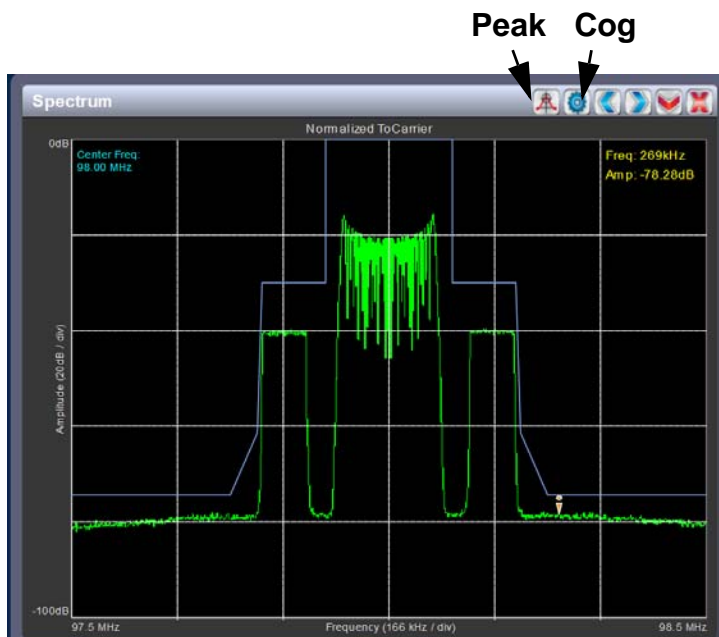

Use the left and right buttons to make fine adjustments.

Use the maximize or minimize buttons as required.

Use the "peak" button to place the cursor on the next successive peak (moving left to right) in the spectrum.

Use the "cog" button to gain access to spectrum settings (see [Figure 3.2.24](#)) such as:

- Resolution Bandwidth: determines the FFT bin size or the smallest frequency that can be resolved. Allowable range is 75 - 10,000 Hz. Default setting is 1000 Hz.
- Span: determines the start and stop frequencies of the analyzer with the carrier frequency always at the center. Allowable range is 10 - 1200 kHz. Default setting is 1000 kHz.
- Averages: determines the number of averages that the analyzer performs per sweep. Press the Clear Averaging button to restart the averaging process. Allowable range is 0 - 100 kHz. Default setting is 19.
- Measurement Source: determines the source of the spectrum plot (transmitter output, audio analyzer, etc.) that is being displayed. Selecting TX Output uses the exciter's RF sample feedback signal to display the RF output spectrum. Selecting Internal (Post EQ) displays the signal that will be produced by the exciter. Selecting Internal (FM) uses the exciter's RF signal, before being equalized (if applicable). FM spectrum analyzer bandwidth is defaulted to 1 MHz, but can be increased to 1.2 MHz. Selecting MPX bandwidth displays the entire composite baseband signal (100 kHz wide).

Figure 3.2.24: Spectrum Settings

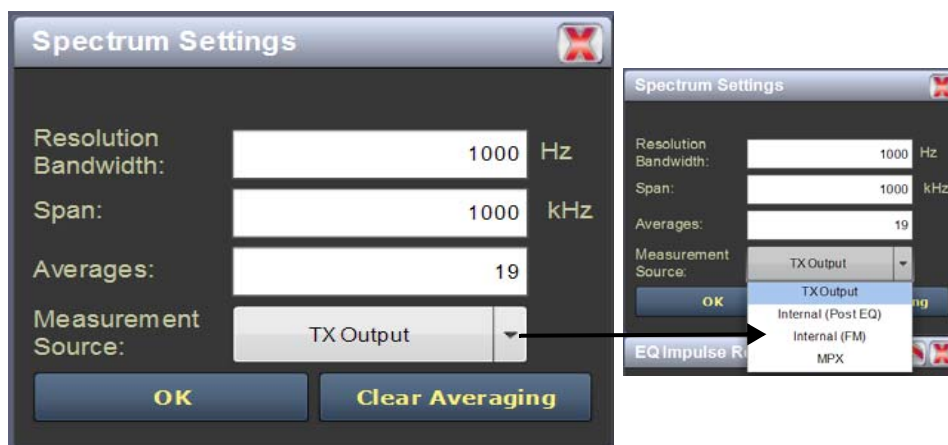

NOTE: If you are using exciter A (controller) only, the FM spectrum analyzer displays the ideal spectrum generated by the DSP. It is not necessarily the same as the spectrum seen at the RF output. If you are using the optional exciter B (exciter), the spectrum analyzer can display the actual RF output sample.

Equalizer Screens

The NV20LT/NV15LT's exciter includes a fixed equalizer to optimize audio performance. There are three menus available in the tool panel - EQ Frequency, EQ Impulse Response and EQ Filter Delay. Coefficients are selected based on your channel frequency. All frequencies shown are relative to the channel frequency.

Figure 3.2.25: EQ Frequency Response

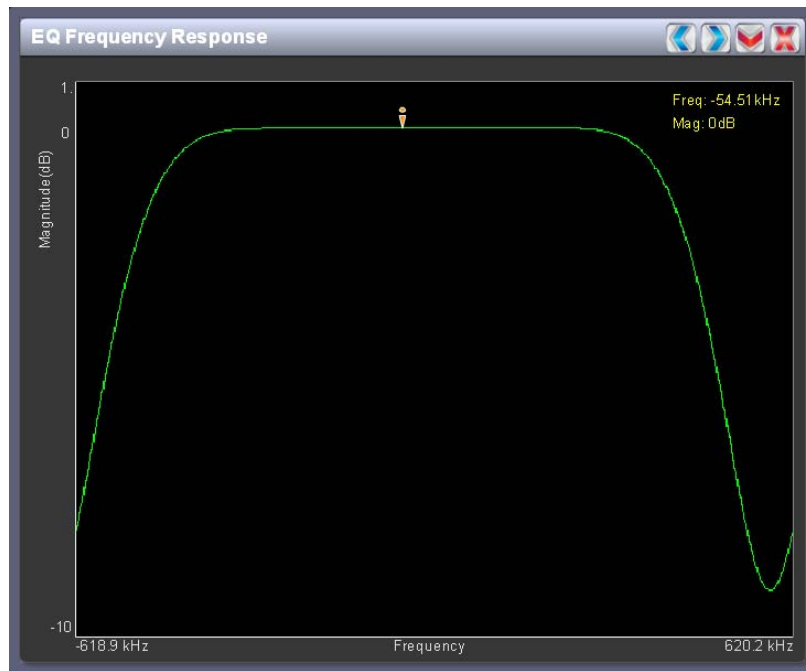

EQ Frequency Response

See [Figure 3.2.25](#). This panel displays the frequency response of the exciter's EQ filter. The panel displays the gain of the filter with respect to the magnitude and frequency of the modulating signal. A dashed line is displayed at the 0 dB level.

This tool is useful for installations featuring filter coefficients loaded to compensate for a channel combiner response.

Click on the panel to display a cursor in the approximate area. The cursor position (magnitude and amplitude) is noted in the upper, right-hand corner of the panel. Click in other areas of the panel to provide a coarse adjustment of the cursor position.

Use the left and right buttons to make fine adjustments to the cursor position.

Use the up or down button to maximize (if it was minimized) or minimize (if it was maximized) the panel size.

Figure 3.2.26: EQ Impulse Response

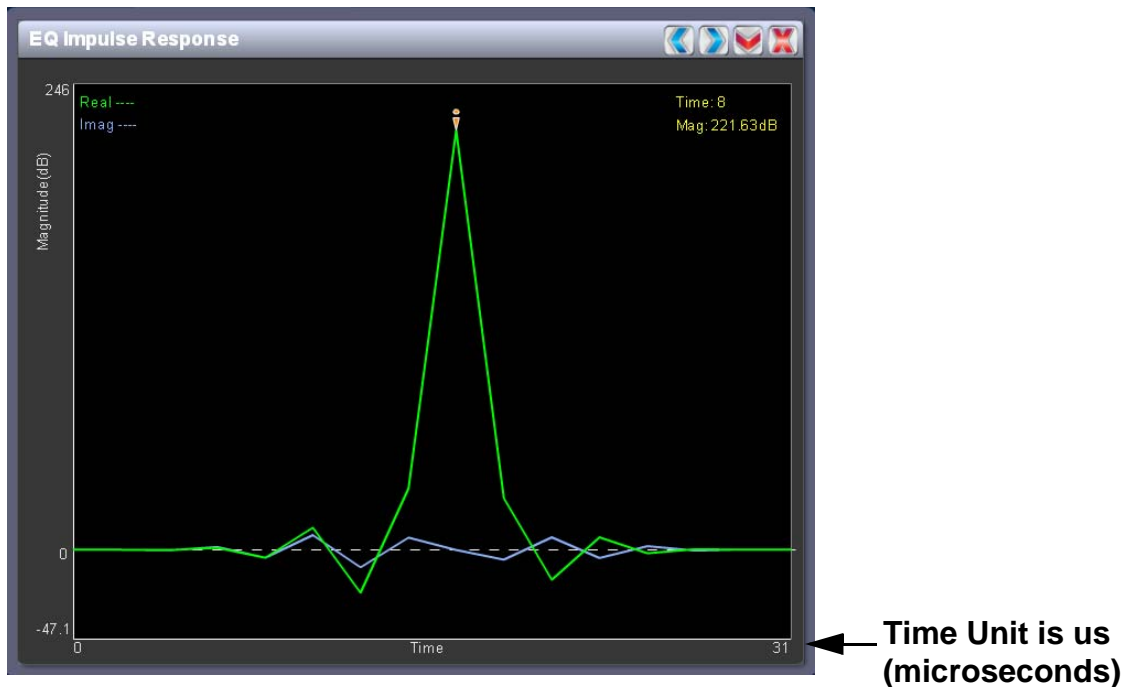

EQ Impulse Response

See Figure 3.2.26. This panel displays the impulse response of the modulator’s EQ filter in the time domain. This is a static display tool so the screen image is not fluid and will not change.

Click on the panel to display a cursor in the approximate area. The cursor position (time and magnitude) is noted in the upper, right-hand corner of the panel. Click in other areas of the panel to provide a coarse adjustment of the cursor position.

Use the left and right buttons to make fine adjustments to the cursor position.

Use the up or down button to maximize (if it was minimized) or minimize (if it was maximized) the panel size.

Figure 3.2.27: EQ Filter Delay

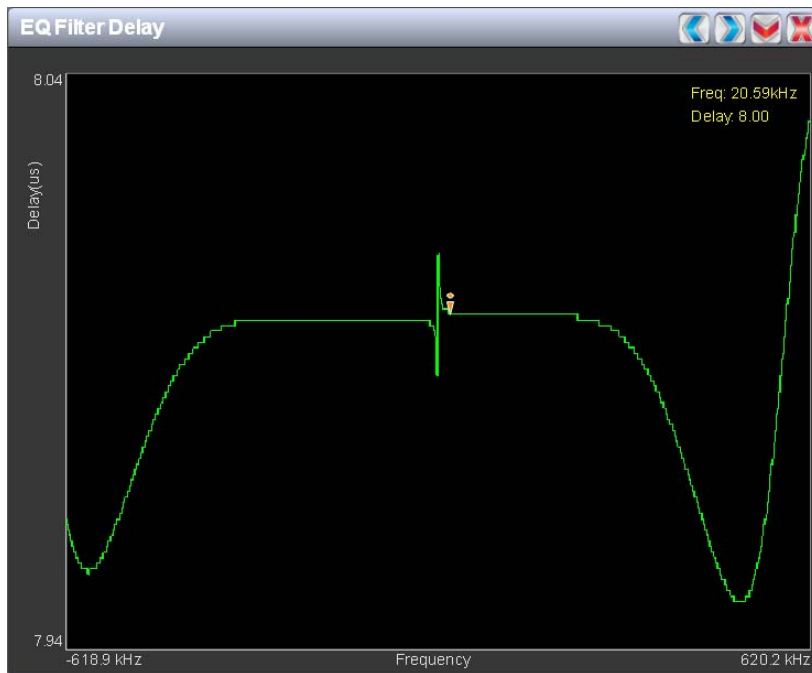

EQ Filter Delay

See [Figure 3.2.27](#). This panel displays the delay of the modulator's EQ filter across its bandwidth.

Click on the panel to display a cursor in the approximate area. The cursor position (frequency and delay) is noted in the upper, right-hand corner of the panel. Click in other areas of the panel to provide a coarse adjustment of the cursor position.

Use the left and right buttons to make fine adjustments to the cursor position.

Use the up or down button to maximize (if it was minimized) or minimize (if it was maximized) the panel size.

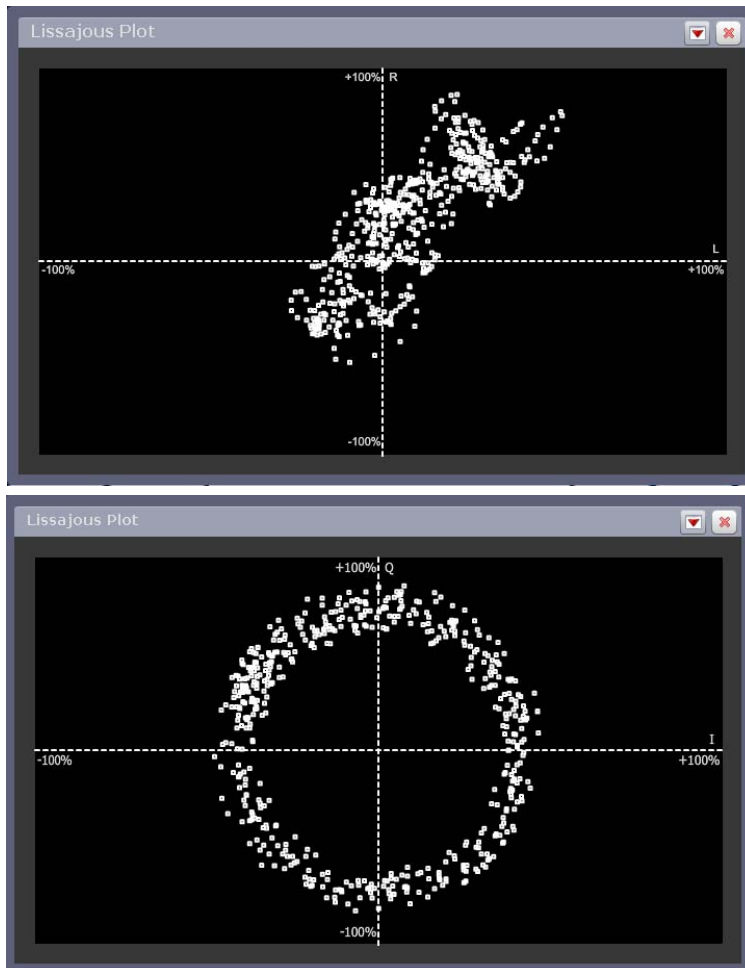
Figure 3.2.28: Lissajous Plots**L and R mode****I and Q mode**

Lissajous Plot

See [Figure 3.2.28](#). This panel displays a Lissajous plot that represents either left and right audio content or a representation of the FM modulated signal (I and Q). I and Q will be automatically selected when using MPX as the main audio source. Left and right audio content is displayed for all other audio sources.

The plot consists of a group of sequential samples to allow signal analysis. In L and R mode, the L+R portion of the signal tends to dominate the plot, resulting in the majority of samples appearing in the lower, left and upper, right quadrants. In I and Q mode, signals that are of equal frequency and 90 degrees out-of-phase result in a circular display.

Use the up or down button to maximize (if it was minimized) or minimize (if it was maximized) the panel size.

Oscilloscope

See [Figure 3.2.29](#). The NV20LT/NV15LT's exciter includes an oscilloscope to allow monitoring of audio input parameters. The oscilloscope displays a real-time waveform for the selected audio input (e.g., L/R audio input). The audio input(s) being monitored is displayed in the upper, left-hand corner of the panel (e.g., R in green, L in blue for L/R audio input.) The limits for the amplitude axis (volts/division) and time axis (microseconds/division) are preset in software for each selected input and cannot be adjusted. The following button controls are available:

Figure 3.2.29: Oscilloscope (Left/Right Audio input shown)

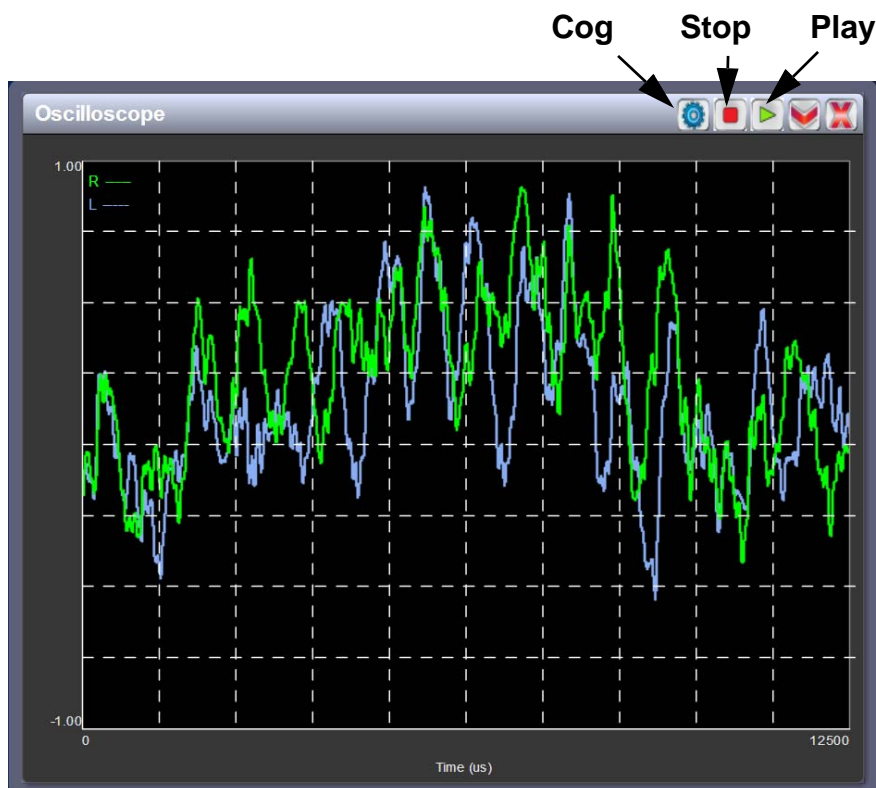

Use the "cog" button to gain access to the measurement source setting (see [Figure 3.2.30](#) on page [3.2.45](#)). Use the drop-arrow to select from the various options - Precorrection Forward/Reverse (shows reverse and forward sample signals), MPX Audio, Left/Right Audio (shows left and right signals) or Audio I/Q (shows I and Q signals).

NOTE: If the test signal generator is enabled, the test signal may appear on certain oscilloscope displays. To view the actual audio input's signal, disable the test signal generator (see [Configure Test Signal Generator](#), on page [3.2.123](#)).

Figure 3.2.30: Measurement Source Settings

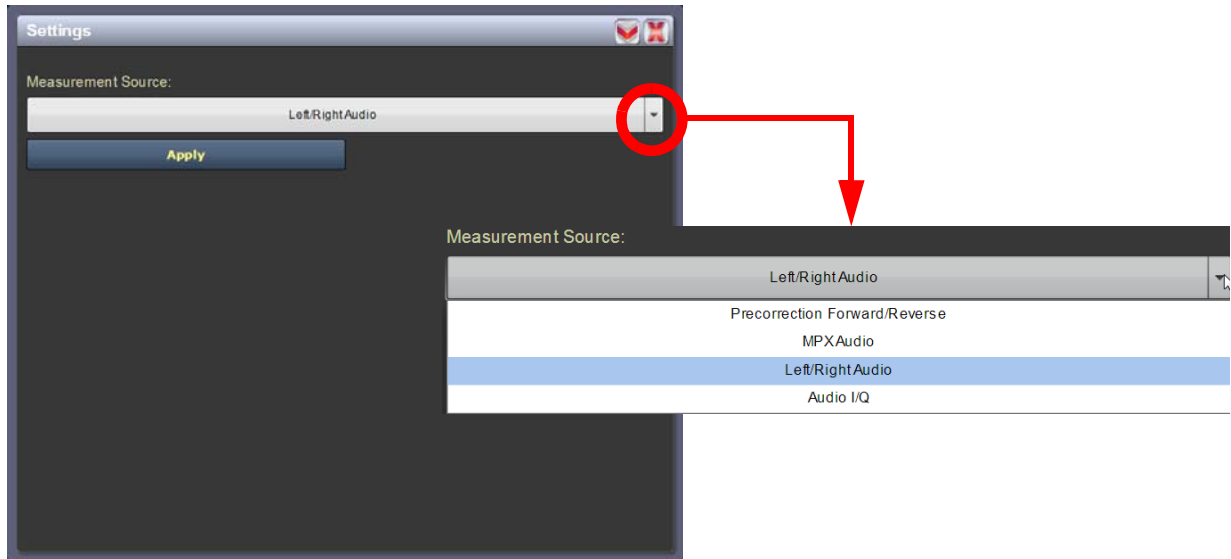

Use the 'stop' button to display a snapshot of the waveform for analysis, printing, etc.

Use the 'play' button to resume the live, real-time display of the waveform.

Use the up or down button to maximize (if it was minimized) or minimize (if it was maximized) the panel size.

Viewing Real-Time Meters

You can view meters using the AUI (see [Viewing Real-Time Meters - using the AUI, on page 3.2.46](#)) or using the front panel UI (see [Viewing Real-Time Meters - Front Panel, on page 3.2.51](#)).

Viewing Real-Time Meters - using the AUI

The AUI can be used to display metered parameters on the Home page (see [Figure 3.2.31](#)), if selected individually from the *Meters List View* page or saved in a meter list layout and set to default.

This section includes the following topics:

- [Describing the Meter Display, on page 3.2.47](#)
- [Accessing Meter Information, on page 3.2.47](#)
- [Identifying Meter Information on a Specific Sub-device, on page 3.2.48](#)
- [Saving a Meter List, on page 3.2.50](#)

Figure 3.2.31: Meters Page

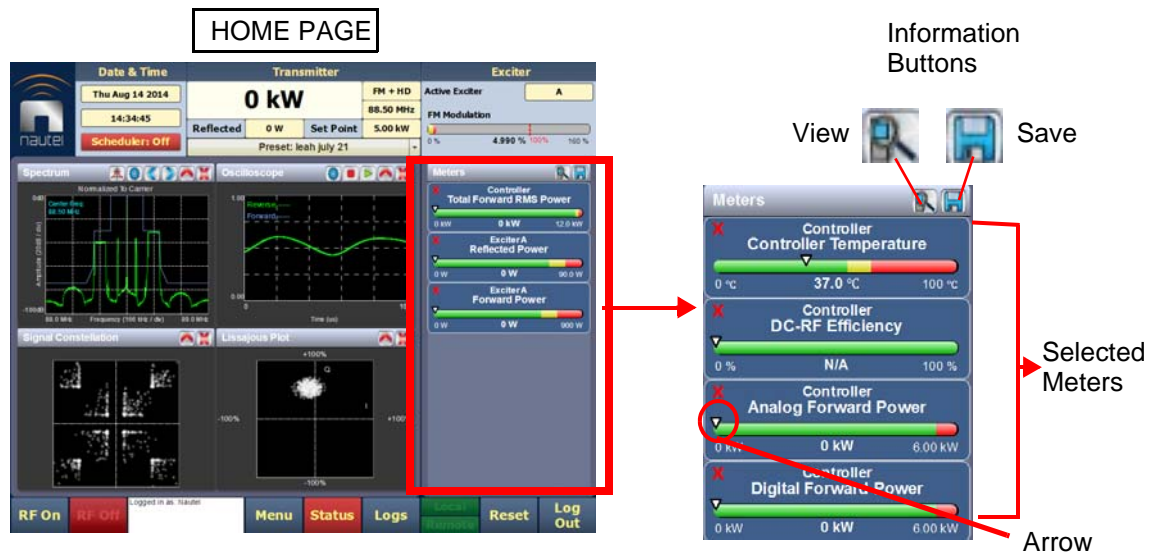

Describing the Meter Display

The meters displayed in the AUI represent the active meters selected for display. Each meter is a colour-coded bar with minimum and maximum values (see [Figure 3.2.32](#)). The current value for a meter is indicated by an arrow on the colour-coded bar, as well as a numeric value below the meter.

- A parameter value in the green section of a meter bar indicates the parameter is within the range for normal operation.
- A parameter value in the yellow section (as applicable) of a meter bar indicates the parameter is still within an operational range, but is approaching design limitations.
- A parameter value in the red section of a meter bar indicates the parameter is outside normal operating conditions.

Accessing Meter Information

Procedures for accessing and editing information in the Meters section of the AUI screen:

- To delete a meter from the Home page, press **X** in the Meters window ([Figure 3.2.32](#)).
- To review all the meter options, press the meter list view shortcut button (magnifying glass) at the top of the meters panel (see [Figure 3.2.32](#)). This will open the Meter List View window.
- On the Meter List View screen users can see all relevant meters of a sub-device. Select the sub-device in question under the Transmitter Layout column and the Relevant Meters column will be populated. The desired Meters can now be selected.

Figure 3.2.32: Meters List View Window (Exciter A shown)

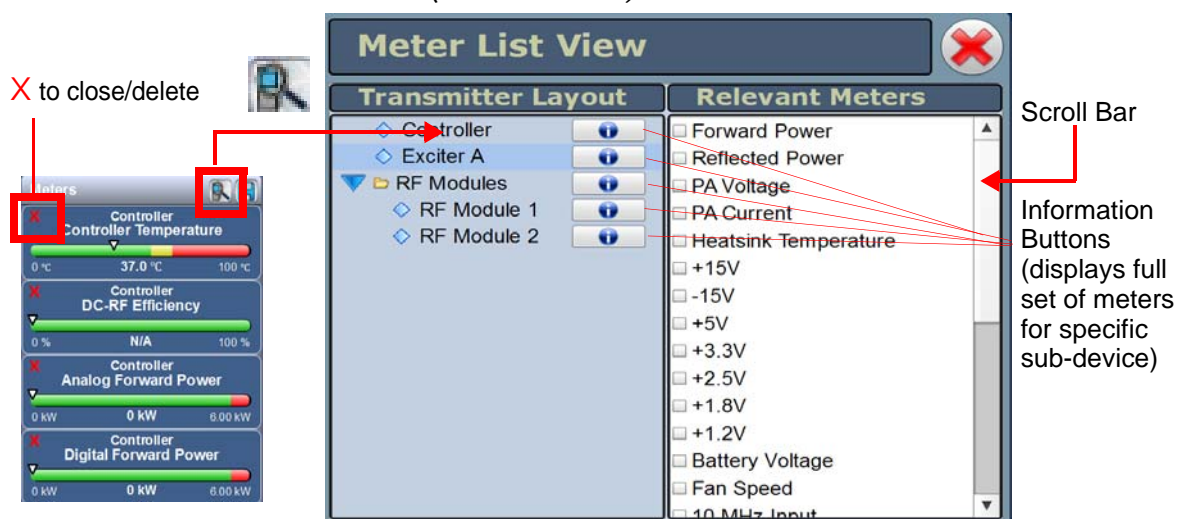

Identifying Meter Information on a Specific Sub-device

1. Open the Meters List View window and select one of the desired transmitter sub-devices.
 - ❖ Controller
 - ❖ Exciter A or B
 - ❖ Rack - Multiple racks supported
 - ❖ RF Modules - Multiple modules supported
2. Under Transmitter Layout, press the information button (i) beside a device type. This will open an information window in tabular format (see [Figure 3.2.33](#)).
3. To choose individual meters for display in the Meters window of the Home page: Select the device type name in the Transmitter Layout panel and select the checkbox next to the desired meters shown in the Relevant Meters panel (see [Figure 3.2.32 on page 3.2.47](#)). If the Relevant Meters panel contains more than one page of information, use the scroll bar (right-side) to find the desired meter.

**Note:**

When a meter value is updated, a blue box briefly appears around that value. Typically, updates occur every one or two seconds.

In the exciter meter screen, MPX SCA meter displays “N/A” if MPX is the main audio source.

Figure 3.2.33: Meters - Information (Device type Controller shown)

Controller
✖

		Firmware Version		2.6.3.3	
		CPLD Version		8.0.0.0	

Meters

Remote Enabled	Remote	DC-RF Efficiency	N/A	+15V	14.9 V	Total Reject Power	0 W
RF On/Off	Off	Average Active PA Power	0 W	+12V A (AUI)	0 V	5kW Reject 1-2 Power	0 W
Total Forward RMS Power	0 kW	Average PA Voltage	2.11 V	+12V B (SBC)	0 V	5kW Reject 3-4 Power	0 W
Analog Forward Power	0 kW	Total PA Current	0 A	+5V	4.99 V	10kW Reject 1-4 Power	0 W
Digital Forward Power	0 kW	Average PA Dissipation	0 W	+3.3V	3.26 V	5kW Reject Fan 1 Speed	0 rpm
Reflected Power	0 W	PWB Temperature	43.8 °C	+1.8V	1.81 V	5kW Reject Fan 2 Speed	0 rpm
VSWR	N/A	Fan Speed	0 rpm	+1.2V	1.17 V	10kW Reject Fan 1 Speed	0 rpm
RF Output Return Loss	N/A	LVPS Input Voltage	39.2 V	Total RF Drive Power	0 W		
DC Input Power	0 kW	Battery Voltage	2.84 V	RF Drive Splitter Temperature	23.4 °C		

Alarms

Saving a Meter List

NOTE: Meter lists are associated with user accounts. Lists saved in this screen are only displayed in the current user account. Setting a list as default will define the meters that will appear when logging into the current account (or after an ac power interruption in the local AUI if this is the default user account).

To save meter specifics for display on the Home page:

Open the Meter List Save window from the Home page using the floppy disk button (Figure 3.2.34).

- ❖ Press Save As to save the currently displayed meters. Enter a name in the Layout Name entry box and press OK.
- ❖ Press Delete to discard the selected meter list.
- ❖ Press Set Default to set the selected meter list as the default for the current user account. The * symbol shows the default.
- ❖ Press Save to overwrite the selected meter list with the currently displayed meters.
- ❖ Press Load to display the meters saved under the currently selected meter list in the Meters panel on the right-hand side of the Home page.

Figure 3.2.34: Meter List Save Window

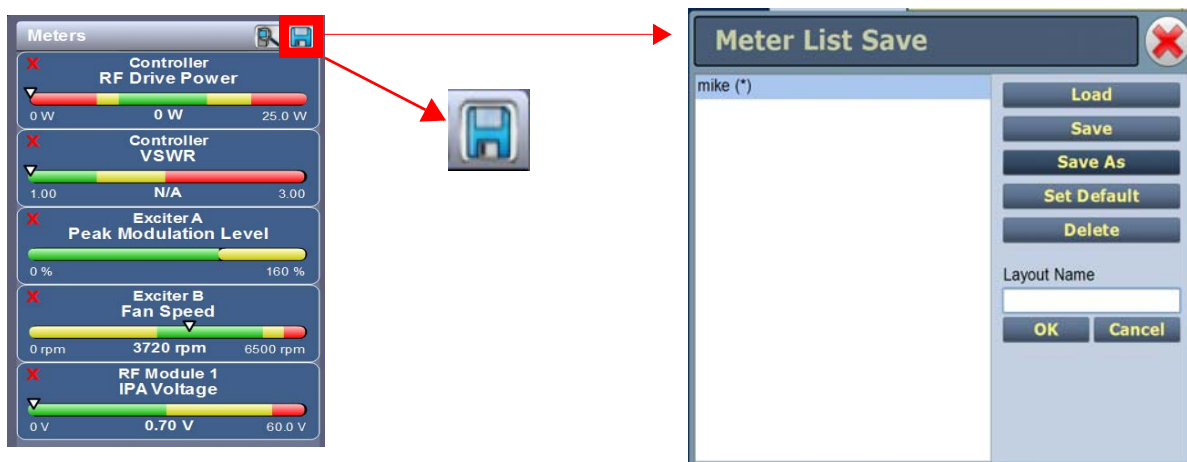

Viewing Real-Time Meters - Front Panel

When you select View Status -> View Meters from the Main Menu (see [Figure 3.2.35](#)) you can view various metered parameters of the NV20LT/NV15LT. These parameters are divided into sections. When you select a particular section, the applicable meters are displayed as a list on the appropriate screen.

NOTE: The View Meters screens are for viewing purposes only and do not offer the same level of analytical features as the AUI's Meter List View page (see [Figure 3.2.31](#) on page 3.2.46).

Figure 3.2.35: View Meters Screens

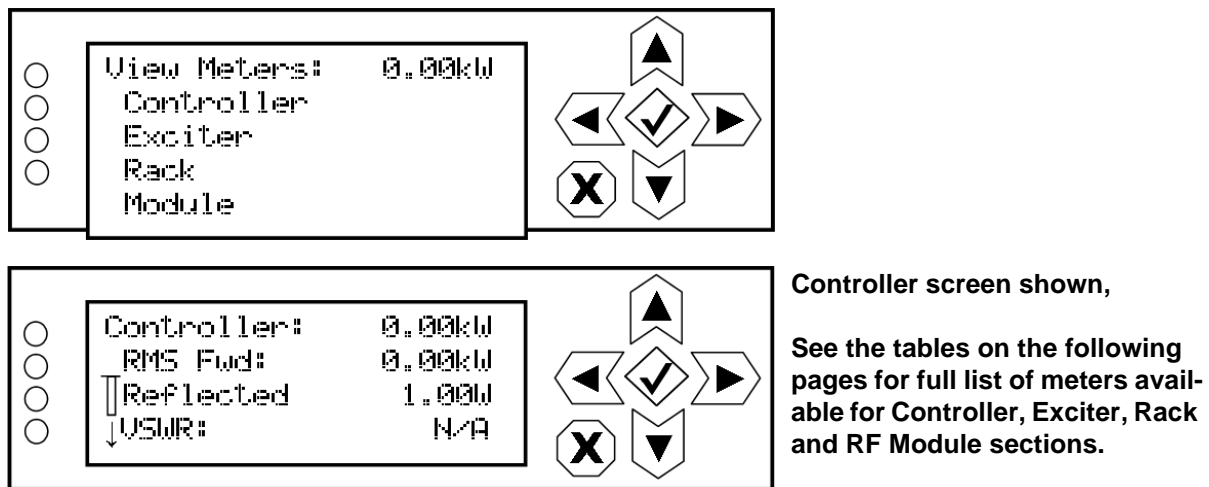

Use the up and down buttons to scroll through the meter sections. Press the accept (checkmark) button to enter the meters screen for that section (see Controller example in [Figure 3.2.35](#)). Use the up and down buttons to scroll through the list of metered parameters one at a time and use the right arrow to 'page down' through the list of metered parameters, noting that the parameters in the following tables are available for viewing.

NOTE: In the RF Module meter screen, pressing the checkmark button will change the sorting of the PM meters. For example: normally the meters are displayed for PM1, then PM2, etc. When you press checkmark, the meters sort by parameter (e.g., PM1 PA Voltage A, PM2 PA Voltage A, etc.) to allow easier viewing of a specific parameter for all RF modules.

CONTROLLER:

RMS Forward Power	+1.2V	Reject 9-12 Power, as applicable
Reflected Power	RF Drive Power	Reject 13-16 Power, as applicable
VSWR	RF Drive A	Reject 1-8 Power, as applicable
DC Power In	RF Drive B	Reject 9-16 Power, as applicable
DC-RF Efficiency	RF Drive 1-8 Power, as applicable	Splitter Fan 1 Speed
RF Power Per PA	RF Drive 9-16 Power, as applicable	Splitter Fan 2 Speed
Avg. PA Volts	RF Drive Reject	Reject 5kW Fan1 Speed
Total PA Current	Total Reject Power	Reject 5kW Fan2 Speed
Avg. PA Dissipated Power	Reject 1-2 Power	Reject 5kW Fan3 Speed, as applicable
Avg PS Current	Reject 3-4 Power, as applicable	Reject 5kW Fan4 Speed, as applicable
PWB Temperature	Reject 5-6 Power, as applicable	Reject 5kW Fan5 Speed, as applicable
LVPS Voltage	Reject 7-8 Power, as applicable	Reject 5kW Fan6 Speed, as applicable
Battery Voltage	Reject 9-10 Power, as applicable	Reject 10kW Fan1 Speed, as applicable
+15V	Reject 11-12 Power, as applicable	Reject 10kW Fan2 Speed, as applicable
-15V	Reject 13-14 Power, as applicable	Reject 10kW Fan3 Speed, as applicable
+5V_A	Reject 15-16 Power, as applicable	Reject Final Fan1 Speed, as applicable
+5V_B	Reject 1-4 Power, as applicable	Reject Final Fan2 Speed, as applicable
+3.3V	Reject 5-8 Power, as applicable	Reject Final Fan3 Speed, as applicable
+1.8V	Reject 9-12 Power, as applicable	

EXCITER (A/B, AS APPLICABLE):

Exc Fwd Power	Exc +15V	Dig 1 L Level
Exc Refl Power	Exc -15V	Dig 1 R Level
Exc PA VSWR	Exc +5V_A	Dig 2 L Level
Exc PA Voltage	Exc +5V_B	Dig 2 R Level
Exc PA Current	Exc +3.3V	MPX SCA Level
Exc PA Bias Voltage	Exc +1.8V	AGC Limit
Exc PA Dissipation	Exc +1.2V	MPX Limit
Exc Preamp Voltage	Exc Battery Voltage	Peak Mod %
Exc Preamp I (current)	Bal L Level	Delta 10 MHz
Exc Preamp Bias Voltage	Bal R Level	MPX RMS %
LVPS Voltage	MPX Level	Reverse Attenuation
Exc PA Temp	Int SCA1 Level	Forward Attenuation
Exc Fan Voltage	Int SCA2 Level	DAC Gain %
Exc Fan Speed		
Exc PWB Temperature		

RACK # (1 THROUGH 8, AS APPLICABLE):

Rk +15V	Rk Ambient Temperature	Rk Fan 3 Speed, as applicable
Rk +5V	Rk Reject Fan Voltage	Rk Fan 4 Speed, as applicable
Rk +3.3V	Rk Fan 1 Speed	Rk PAs OK
Rk LVPS	Rk Fan 2 Speed	Rk Rej Fan OK

RF MODULE (PM1, REPEAT FOR PM2 THROUGH PM8):

PM1 Drive Power	PM1 Fan 5 Speed	PM1 PS B Current
PM1 PA 1 Curr	PM1 Fan 6 Speed	PM1 PS A Temperature
PM1 PA 2 Curr	PM1 Temperature	PM1 PS B Temperature
PM1 PA 3 Curr	PM1 Bias 1 Voltage	PM1 PS A Fan Speed
PM1 PA 4 Curr	PM1 Bias 2 Voltage	PM1 PS B Fan Speed
PM1 PA Voltage A	PM1 Bias 3 Voltage	PM1 PS A Input Voltage
PM1 PA Voltage B	PM1 Bias 4 Voltage	PM1 PS B Input Voltage
PM1 Fan Voltage	PM1 Reject Power	PM1 PS A Input Current
PM1 Fan 1 Speed	PM1 PS A Voltage	PM1 PS B Input Current
PM1 Fan 2 Speed	PM1 PS B Voltage	PM1 PS A Run Time
PM1 Fan 3 Speed	PM1 PS A Current	PM1 PS B Run Time
PM1 Fan 4 Speed		

Presets - Editing Operational Settings

You can manage presets using the remote AUI (see [Managing Presets - Using the AUI](#)) or using the local front panel display (see [Managing Presets - Using the Front Panel](#), on page 3.2.73).

Managing Presets - Using the AUI

The Presets page (see [Figure 3.2.36](#)) allows users with the appropriate permissions to view operational data (power level, frequency, mode, program input characteristics), plus create and control preset settings. Users can create up to 62 presets or edit existing presets. To view the Presets page, select Presets in the Menu page. This section includes the following topics:

- [Editing or Creating Presets](#), on page 3.2.55
- [Loading Presets](#), on page 3.2.56
- [Understanding the Preset Tabs](#), on page 3.2.57

Figure 3.2.36: Presets Page - General Tab shown

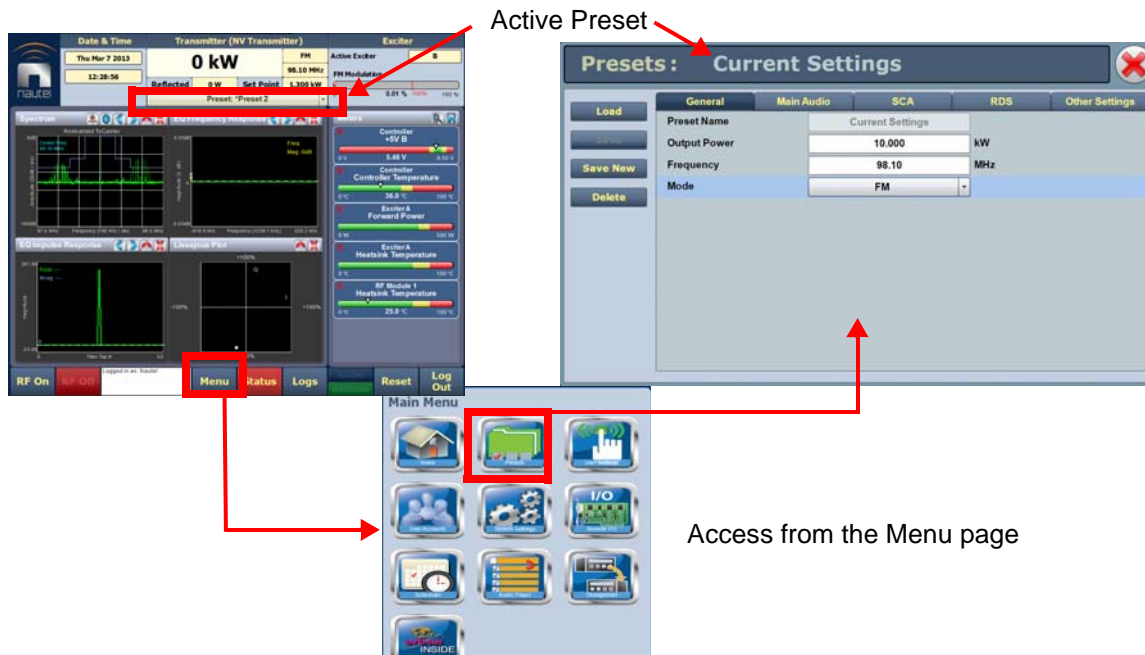

NOTE: When asked to enter a value in a field, an error message may appear (red text at the bottom of the screen) showing the limits of the requested value. Re-enter the desired value, ensuring it falls within the limits shown.

For example: **Output Power - Valid values: 0.15kW to 5.5kW (for 5 kW transmitter)**

Editing or Creating Presets

When a presets page is opened from the menu, (for example see [Figure 3.2.36 on page 3.2.54](#)), the Current Settings of the transmitter are displayed. They define the current operational state of the transmitter. Current Settings can be edited and then immediately activated by pressing the Save button.

To edit a saved preset, you must load that preset from the Presets page (see [Loading Presets, on page 3.2.56](#)). If the edited preset was active before it was edited, saving the preset will update the preset, but the Current Settings will not change. To update the operation of the transmitter, re-activate the preset through the top banner (see [Activating Presets, on page 3.2.56](#)).

In the top banner (see [Activating Presets, on page 3.2.56](#)), an asterisk (*) appears next to the preset name when the Current Settings have changed since the last preset was loaded. Current Settings are not saved through an ac power cycle; when the transmitter recovers from an ac power loss, it loads the preset that was last activated.

On the Presets page, an asterisk (*) appears next to the preset name in the header when there are unsaved changes to the preset.

When changes are complete, press the Save button and then press the Save Preset window's Save button to enable the changes. If you are creating a new preset, you can also enter a new name (e.g., Preset 4 - MPX) in the preset window before clicking the Save or Save New button.

Parameters that can be edited are discussed in detail in [Understanding the Preset Tabs, on page 3.2.57](#).

To remove a preset, select it and press the Delete button.

To ignore any changes, press Cancel to return to the Presets page.

Loading Presets

When first entering the Presets page, the current “active” preset is displayed (see [Figure 3.2.36 on page 3.2.54](#)). If the current preset is not the desired one, use the Load button on the left-side of the AUI to call up a window containing a list of available presets.

Select the desired preset and press the Load button to view or enable editing of the preset. Press the Delete button to delete the selected preset. Users cannot delete the current “active” (operational) preset or any preset that is referenced in the Remote I/O menu as either a remote input or output. Those links in the Remote I/O menu must be deleted before the associated preset can be deleted. Press Cancel to return to the Presets page.

Activating Presets

In the Transmitter block in the AUI’s top banner, press the bar that contains the active preset name and the drop-down arrow (see [Figure 3.2.37](#)). The Activate Preset window will appear, which contains a list of all preset options. Press and highlight the desired preset and press the Activate button to enable the preset as the transmitter’s active preset. Press the Cancel button to close this window.

Figure 3.2.37: Activating Presets

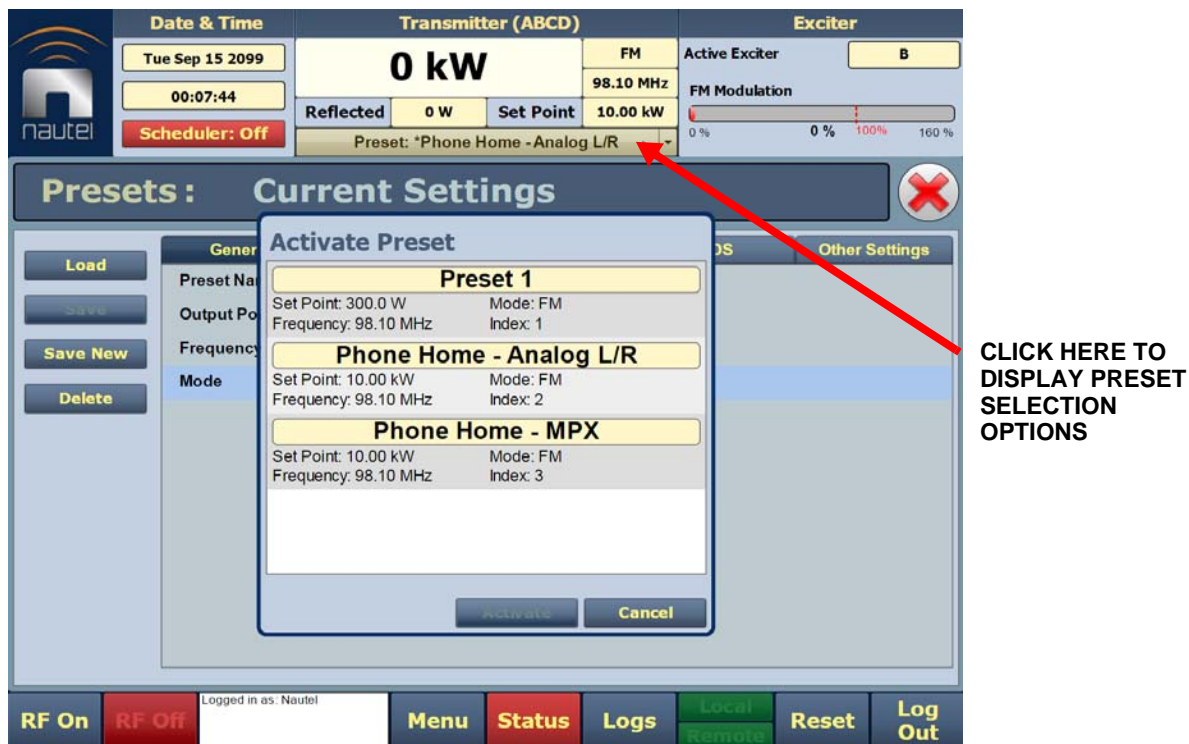

Understanding the Preset Tabs

The Presets page consists of tabs across the top with functions on the left-side and parameters displayed in the center and right-side of the window. A separate display appears for each of the following tabs:

General - (see [Figure 3.2.36](#) on page 3.2.54)

- **Preset Name:** This field identifies the current preset settings. Users must load a preset to directly edit this field (see [Activating Presets](#), on page 3.2.56).
- **Output Power:** Set the output power level (in kW). See the Pre-Installation Manual for RF output power ratings for this transmitter. See [Output Power](#), on page 3.2.75 for exceptions to minimum power capabilities.
- **Frequency:** Set value. Valid frequencies are between 87.00 and 108.00 MHz.
- **Mode:** FM mode only

NOTE: *Settings on the Presets tabs are shown/hidden based on the chosen settings. Not all settings are available in all modes.*

Figure 3.2.38: Presets page - Main Audio tab

The screenshot displays the Nautel transmitter control interface. At the top, there are three main sections: **Date & Time** (Sun Jan 3 2010, 01:34:01, Scheduler: Off), **Transmitter** (0 kW, Reflected 0 W, Set Point 300.0 W, Preset: *Preset 1), and **Exciter** (Active Exciter A, FM Modulation 0.010%). Below this is a **Presets : * Current Settings** header with a close button. The main area is divided into tabs: **General**, **MainAudio** (selected), **SCA**, **RDS**, and **Other Settings**. On the left, there are buttons for **Load**, **Save**, **Save New**, and **Delete**. The **MainAudio** tab contains settings for **Audio Source** (Analog Left/Right), **Analog Level** (0.0 dBu), **Audio Mode** (Stereo), **15kHz Lowpass** (Disabled), **Preemphasis** (0us), and **MainAudio Gain Adjust** (0.0 dB). Below these are **Audio Backup** (Enabled) settings with their own sub-section for **Audio Source** (Analog Left/Right), **Analog Level** (0.0 dBu), **Audio Mode** (Mono L+R), **15kHz Lowpass** (Disabled), and **Preemphasis** (0us). At the bottom, there are **RF On** and **RF Off** buttons, a **Logged in as: Nautel** indicator, and a row of buttons: **Menu**, **Status**, **Logs**, **Local** (with **Remote** below it), **Reset**, and **Log Out**.

Main Audio - (see [Figure 3.2.38](#) on page [3.2.58](#)):

- Audio Source: Connects the appropriate exciter input for use. Available options are:
 - ❖ Analog Left/Right: this source allows for further configuration via Analog Level, Audio Mode (Mono L+R, Mono L, Mono R, Stereo), 15kHz Lowpass, Preemphasis, Main Audio Gain Adjust settings (see below).
 - ❖ MPX: this source allows for further configuration via the MPX Level setting (see below).
 - ❖ MPX Over AES: this source allows for further configuration via the Digital Level setting (see below).
 - ❖ AES/EBU 1 or 2: this source allows for further configuration via Digital Level, Audio Mode (Mono L+R, Mono L, Mono R, Stereo), 15kHz Lowpass, Preemphasis, Main Audio Gain Adjust settings (see below).
 - ❖ Audio Player -> AES 1 or AES 2: this source allows for further configuration via Digital Level, Audio Mode (Mono L+R, Mono L, Mono R, Stereo), 15kHz Lowpass, Preemphasis, Main Audio Gain Adjust settings (see below).

NOTE: *The Audio Player -> AES1 or AES 2 source can be used to accept an external audio playlist on a USB drive that is connected to the USB 3 or USB 4 connector on the rear of the controller (A4). When the audio breakout cable (provided by Nautel) is properly connected, the external playlist is applied to each exciter's AES/EBU IN 1 (A1J5) connector or AES/EBU IN 2 (A1J5) connector via the AUDIO PLAYER AES OUT (A2J6A) connector on the rear of the controller. See the "Planning Program Inputs" section of the Pre-installation Manual for connection details.*

- ❖ Analog Level: applies to Analog Left/Right source only; enter value between -12 and +12 dBu, which represents the input voltage level that yields 100% modulation (typically +12 dBu).
- ❖ Digital Level: applies to AES/EBU 1, Audio Player -> AES 2 and MPX Over AES sources only; enter value between -25.5 and 0 dBFS (typically -4 dBFS for 100% modulation value).
- ❖ Audio Mode: select Mono L, Mono R, Mono L+R or Stereo (applies to Left/Right/Mono, AES/EBU 1 or Audio Player -> AES 2 sources; selecting Stereo applies a 19 kHz pilot).
- ❖ 15kHz Lowpass Filter: applies to Left/Right/Mono, AES/EBU 1 and Audio Player -> AES 2 audio modes; select Enable (applies 15 kHz low-pass filter to audio input) or Disable.
- ❖ Preemphasis: select 0 us, 25 us, 50 us or 75 us. This setting applies to all sources except MPX and MPX over AES sources.
- ❖ Main Audio Gain Adjust: applies to Analog Left/Right, AES/EBU 1 or Audio Player -> AES audio sources only; allowable range is -20 to 10 dB. This configuration setting will increase the incoming signal level and yield a proportional increase in % modulation.
- ❖ MPX Level: applies to MPX source only. Set this parameter level in Vpp (typically 3.5 Vpp - 100% modulation value). The allowable range for this setting is between 1-5 Vpp.

- ❖ **Audio Backup:** When you set Audio Backup to Enable, you can select a backup Audio Source and edit various parameters for the backup audio similarly to the main audio described above. The backup audio source, if enabled and present, will replace the main audio source if the main audio level is less than its user-determined trip threshold (see [Setting User Thresholds - using the AUI, on page 3.2.117](#)). The main audio source will be restored as the active source if it returns and is present for at least one second.

NOTE: See [Configuring a Mod Loss Backup Preset, on page 3.4.5](#) for limitations on audio backup settings.

CAUTION!

Damage can occur if the incoming analog L+R audio exceeds the exciter input level of 25 dBu. Normal operation should not exceed 12 dBu (typically +12 dBu is referenced for 100% modulation).

Figure 3.2.39: Presets - SCA

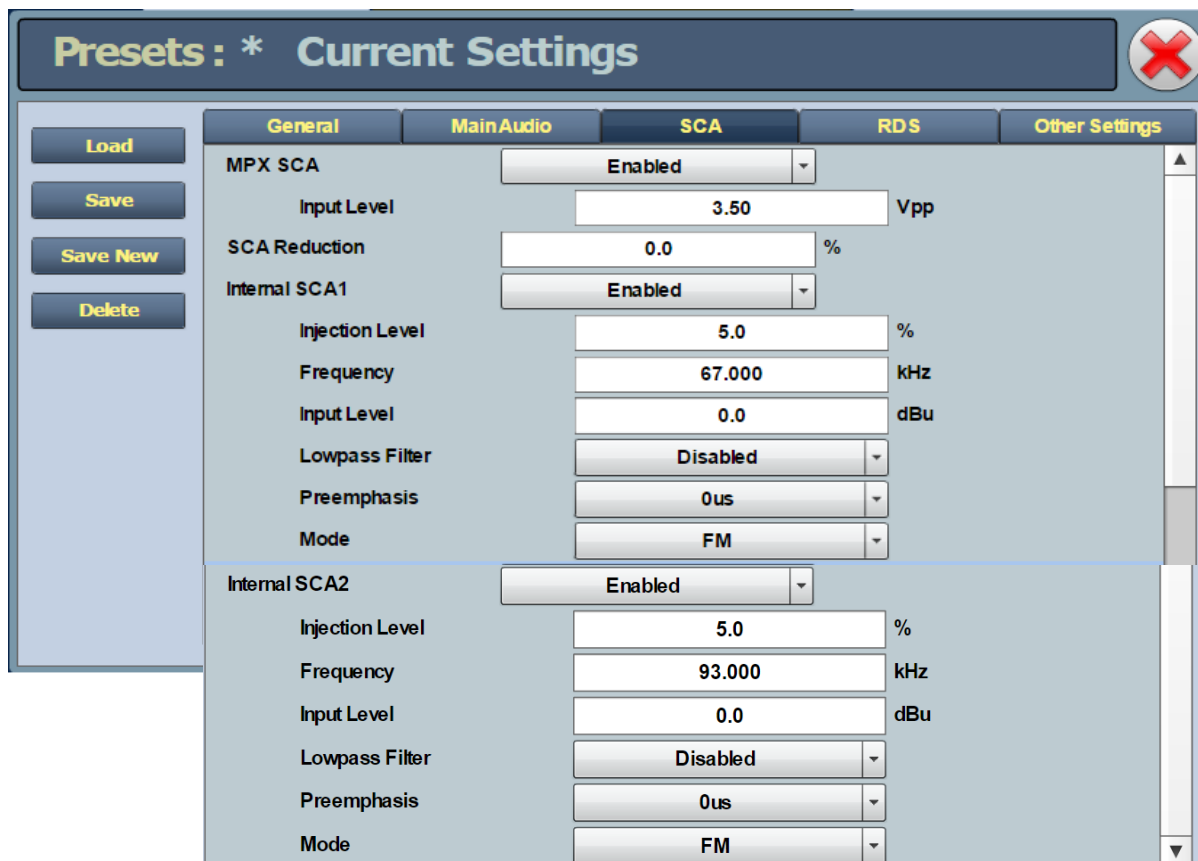

SCA - (see [Figure 3.2.39](#)):

- **MPX SCA:** Connector (J7:A for SCA1, J7:B for SCA2) for use with an externally generated SCA; select Enabled or Disabled. When enabled, all the selections listed below are active.
 - ❖ **Input Level:** signal level that represents 10% modulation. Enter a value between 1 and 5 V p-p (typically 2.83 V p-p).
- **SCA Reduction:** Attenuation applied to the SCA input; set between 0 and 20% (used to reduce the modulation level of the main audio when SCAs are enabled; typically, for every 2% of SCA modulation, the main audio modulation must be reduced by 1%).
- **Internal SCA1/2:** Enable or disable the appropriate internal SCA (SCA1 or SCA2). When enabled, the settings listed below are active for the associated SCA signal (1 or 2).
 - ❖ **SCA1 or SCA2 Injection Level:** enter value between 0 and 20% (typically 10%); this level is added to the composite baseband signal.
 - ❖ **SCA1 or SCA2 Frequency:** enter value between 20 and 100 kHz (typically set to 67 kHz or 92 kHz).
 - ❖ **SCA1 or SCA 2 Input Level:** enter value between -12 and +12 dBu, which represents the input voltage level that yields 10% modulation (typically 4.7 dBu).
 - ❖ **SCA1 or SCA2 Lowpass Filter:** select Enabled (applies 7.5 kHz low-pass filter to audio input) or Disabled.
 - ❖ **SCA1 or SCA2 Preemphasis:** select 0 us, 50 us, 75 us or 150 us.
 - ❖ **SCA1 or SCA2 Mode:** select FM (frequency modulated sub-carrier, typical) or DSB-SC (double side band suppressed carrier).

NOTE: *Check your local broadcast regulatory body's guidelines for allowable modulation depth with SCAs or RDS enabled.*

Figure 3.2.40: Presets page - RDS tab (scroll to see all options)

Presets : * Current Settings
✕

Load

Save

Save New

Delete

General	MainAudio	SCA	RDS	Other Settings
RDS				
			Enabled	
Data Source			ASCII over Serial	
RDS Local Echo			Disabled	
Injection Level			0.0	%
Phase			0.0	°
Baud Rate			19200bps	
PI Code (hex)			0x0000	
PS Name				
Scrolling Enable/Speed			Off	
Scrolling PS Name				
Scrolling Type			Word	
Radio Text				
PTY			0: NONE/NONE	
PTYN				
Music/Speech			Speech	
Traffic Info			None	
Alt. Frequencies			None	
Artificial Head			Disabled	
Compression Flag			Disabled	
Dynamic PTY			Static	
Stereo			Mono	

RDS - (see [Figure 3.2.40](#)):

For RDS operation, an external unit or software can send data to the exciter, serially or over IP. The exciter generates the RBDS/RDS carrier and injects the data; externally generated, or alternatively, the Presets page offer a means to configure internally generated data.

Refer to [RDS Remote Protocol](#), on [page 3.2.65](#) for information on using the ASCII protocol to remotely configure RDS settings and to observe the strings supported by Nautel.

NOTE: *The UECP protocol is fully supported.*

NOTE: *The differences between RDS (European) and RBDS (North American) are not outlined in this manual. Presets created using the NV20LT/NV15LT are compatible with either type.*

- RDS: select Enabled or Disabled (default is Disabled). When enabled, all of the selections below are active:

NOTE: *When using the internal data source, you must correctly enter all RDS fields - specifically PI Code or PS Name - to ensure proper reception of RDS information.*

- ❖ Data Source: select Internal, ASCII over Serial, UECP over Serial, ASCII over IP, or UECP over IP.

NOTE: *For ASCII over IP data or UECP over IP data, send RDS information to the IP address of the NV20LT/NV15LT, port 7005.*

- ❖ RDS Local Echo (displayed only when Data Source is ASCII over Serial). Select Enabled or Disabled (default is Disabled). When Enabled, the exciter RDS port transceiver will echo all inputs and controls received back to the terminal.
- ❖ Injection Level: enter value between 0 and 10% (typically 5%, default is 0%). This level is added to the composite baseband signal.

NOTE: *Check your local broadcast regulatory body's guidelines for allowable modulation depth with SCAs or RDS enabled.*

- ❖ Phase: enter value in degrees between 0 and 360 (default is 0.0 degrees).
- ❖ Baud Rate (displayed only when Data Source is ASCII over Serial or UECP over Serial): select 75, 150, 300, 600, 1200, 2400, 4800, 9600, 19200, 38400, 57600 or 115,200 bps (default is 19200). Does not apply to the Internal data source.

The Presets -> RDS page selections below Baud Rate apply only to the Internal data source.

- ❖ PI Code (hex) (Program Identification code): enter four hex digits that represent the station call sign (e.g., PI=1AE5); this unique code is used to identify a broadcast station. Every station gets assigned a specific code with a country identifying prefix. In the USA this code is determined by applying a formula to the station's call sign. More information can be found at www.nrcstandards.org. In Canada this code is determined using the Spectrum Management and Telecommunications tool found at www.ic.gc.ca. Contact your local broadcast regulatory body for details on determining your unique PI Code.
- ❖ PS Name (programme service name): this is simply a maximum 8-character "tagline" static display that represents the call letters or station identity name. Most RDS capable receivers display this information and, if the station is stored in the receiver's presets, will cache this information with the frequency and other details associated with that preset. Default is blank.
- ❖ Scrolling Enable/Speed: determines the scrolling speed of the Scrolling PS Name. Select Off (disabled), Slow (transitions every 10 s) or Fast (transitions every 3 s). Default is Off.
- ❖ Scrolling PS Name: if used, enter up to 64 characters for the PS name that will scroll (if enabled) at the speed selected in the Scrolling Enable/Speed field. Information is displayed on the receiver based on transmitter configuration; however, is limited to 8 characters maximum. Default is blank.
- ❖ Scrolling Type: select the type of scrolling to be used by the receiver - Word or Character. Word scrolling displays and transitions a maximum of 8 characters of the Scrolling PS Name at a time. Character scrolling still displays a maximum of 8 characters; however, transitions by one character of the Scrolling PS Name at a time. In both cases, transitions occur at the speed defined by the Scrolling Enable/Speed selection (Slow or Fast). The default selection is Word.

NOTE: *Words are defined by the location of spaces in the Scrolling PS Name. Words that are longer than 8 characters will scroll by character until the entire word is displayed and then continue with the next word.*

- ❖ Radio Text: Most RDS radios can receive short messages that may include information about the presenter, station or program you are listening to (e.g., a web address for the station). You can enter radio text up to 64 characters in length. Information is displayed on the receiver based on the receiver configuration and capability (e.g., maximum number of characters on the screen). Default is blank.
- ❖ PTY: this coding of up to 32 (0 to 31) pre-defined programme types allows users to find similar programming by genre. Default is 0: NONE/NONE.
- ❖ PTYN (programme type name): this field can be used for detailed description of the PTY by 8 digits. Example: if the PTY is 4 (Sport) a PTYN like "Football" could be transmitted. The PTYN is intended for displaying additional information only and cannot be used for automatic station tuning like the PTY. The PTYN is optional. Default is blank.

- ❖ Music/Speech: select Music or Speech. Default is Speech.
- ❖ Traffic Info: select None, TA (Traffic Announcement), TP (Traffic Programme) or TA+TP. The receiver can often be set to pay special attention to this flag and, for example, stop the tape/ pause the CD or retune to receive a traffic bulletin. The TP flag is used (set to 1) to allow the user to find only those stations that regularly broadcast traffic bulletins whereas the TA flag is used (set to 1) to signal an actual traffic bulletin in progress. These flags are set to 0 if they are not being used for traffic information. Default is None.
- ❖ Alt. Frequencies: select None or 1 through 25. This allows a receiver to re-tune to a different frequency providing the same station information (i.e., using translators or repeaters) when the first signal becomes too weak. This is often utilized in car stereo systems. Default is None.
- ❖ Artificial Head (bit 1 of DI, see NOTE below): select Enabled or Disabled. This selection is a decoder identification operating mode flag. Default is Disabled.
- ❖ Compression Flag (bit 2 of DI, see NOTE below): select Enabled or Disabled. This selection is a decoder identification operating mode flag. Default is Disabled.
- ❖ Dynamic PTY (bit 3 of DI, see NOTE below): select Dynamic or Static. This selection is a decoder identification operating mode flag. Default is Static.
- ❖ Stereo (bit 0 of DI, see NOTE below): select Stereo or Mono. This selection is a decoder identification operating mode flag. Default is Mono.

NOTE: *Artificial Head, Compression Flag, Dynamic PTY and Stereo are part of the DI (Decoder Information) data (see UI editing screens on [Figure 3.2.58](#) on [page 3.2.83](#)). RDS Data is provided as a single-digit hex input between 0 and F, that encodes the flags for the four settings as a 4-bit code. For example: hex number 3 is bit-represented by 0011, from bit 3 on the left to bit 0 on the right. This number is decoded to mean Stereo = Yes/Stereo (bit 0=1), Artificial Head = Yes/Enabled (bit 1=1), Compression = No/Disabled (bit 2=0) and Dynamic PTY = No/Static (bit 3=0).*

RDS REMOTE PROTOCOL. The following information is intended to assist users with remote RDS settings using the ASCII protocol.

Assigning Settings: To assign a value to a setting, send the setting name, the equal sign (=) and the desired value. If the setting is valid, the exciter responds "OK". If the setting is invalid, the exciter responds "NO".

```
Examples: PI=1248 // set the PI code to 0x1248
          OK      // exciter responds with OK
          TA=2    // set the traffic announcement to 2 (bad command; only values 0 or 1 allowed)
          NO      // exciter responds with NO
```

Querying Settings: To determine the current value of a setting, type the setting name with a question mark (?) instead of an equal sign (=).

```
Examples: PI?           // query the current PI code
          1248         // exciter responds with "1248", the current PI code
```

Other Considerations:

- Initial Values and Preset Changes

On startup, or when the RDS settings in the active preset differ from the last ones loaded, the preset's initial RDS settings (PS, PI, PTY, PTYN, RT, AF, etc.) will be loaded. If there is an active data source (UECP or ASCII via serial or IP), these settings may be updated externally.

The RDS settings from the preset will only be loaded again if they change, otherwise the working set from the external data source will continue to be used. This allows unrelated preset changes to adjust other settings without affecting RDS functionality.

- Real Time Clock

The controller has a battery-backed real-time clock that keeps track of the time and date. It is possible the exciter's RDS generator could broadcast the incorrect time and date if this is not set correctly, so the broadcast of time must be enabled via ASCII or UECP each time the system is powered up. Until it is enabled, the time will not be broadcast again after a power failure.

- TCP Usage

Use TCP port 7005. This is not user configurable. To use RDS over IP, the connection must be opened before each command.

List of Settings: [Table 3.2.4](#) lists the RDS settings supported by Nautel, including descriptions and examples.

NOTE: *Remote setting of the RDS baud rate is not supported.*

Table 3.2.4: Supported ASCII Settings for RDS

Setting	Name	Description/Example
PI=	Program Identification	Four hex digits representing the station call sign. Consult the RDS/RBDS specification for more information. Example: PI=1AE5
PS=	Program Service	Maximum 8-character ASCII "tagline" string describing the radio station. Example: PS=Q104-FM
PTY=	Program TYPe	Number, from 0 to 31, describing the station format. Example: PTY=24
PTYN=	Program TYPe Name	8-character ASCII string, also describing the station format. Example: PTYN=JAZZ24-7
TP=	Traffic Program	Set to 1 if the current program sometimes carries traffic information, otherwise set to 0. Example: TP=1
TA=	Traffic Announcement	Set to 1 if the current program is currently broadcasting a traffic announcement, otherwise set to 0. Example: TA=0 NOTE: Timeout of the TA flag is not implemented, so the RDS data source should ensure this flag is properly cleared.
AF1= ... AF25=	Alternative Frequency	If the station broadcasts on more than one frequency using translators or repeaters, these are typically set to each of the frequencies used in the broadcast network. Sample calculation for 98.5 MHz: $(98.5-87.8) \times 10 = 107$ Example: AF1=107 NOTE: there is no method to disable AFs in this protocol.

Table 3.2.4: Supported ASCII Settings for RDS

Setting	Name	Description/Example
DI=	Decoder Information	Single hex digit, range 0-9 and A-F (case insensitive) that encodes the flags Stereo(1)/Mono(0) - bit 0; Artificial Head (Yes=1, No=0) - Bit 1; Compression (Yes=1, No=0) - Bit 2; and Dynamic (Yes=1, No=0) - Bit 3 Example: DI=3 (Stereo, Artificial Head=Yes, Compression=No, Dynamic=No)
MS=	Music/Speech	Typically set to 1 if the station broadcasts music, otherwise set to 0. Example: MS=1
TEXT=	Radio Text	Accepts a 1 through 64 character ASCII string, displayed on receivers that support RDS radio text. Example: TEXT=Tears for Fears - Shout (1985)
ECHO=	Echo Enable/Disable	If set to 1, the RDS encoder will echo back characters that are sent to it. If set to 0, the encoder will only send responses. Example: ECHO=1
DATE=	Current UTC date	Format is strictly YYYY-MM-DD. Sets the current UTC date for 4A date/time broadcasts. This is a non-volatile setting. Example: DATE=2016-04-04
TIME=	Current UTC time	Format is strictly HH:MM:SS, 24-hour format. Sets the current UTC time for 4A date/time broadcasts. This is a non-volatile setting. Example: TIME=17:23:05
UTC=	UTC time zone offset	Range is 0 to 24, 32 to 56. Sets the current time zone. To calculate this value, multiply the time offset by 2 and add 32 if the time offset is negative. For Newfoundland (UTC-3.5), $3.5 \times 2 = 7$, and add 32 (since the time zone is negative) to yield 39. This is a non-volatile setting. Example: UTC=39

Table 3.2.4: Supported ASCII Settings for RDS

Setting	Name	Description/Example
CT=	4A date/time enable	If set to 1, the exciter will broadcast a 4A RDS packet on the edge of every minute with the currently set UTC time/date. This is a volatile setting. Example: CT=1
DPS=	Dynamic Program Service (scrolling command)	64-character ASCII string typically describing the radio station. Example: DPS=Q104-FM The Home of Rock N Roll
DPSR=	Dynamic Program Service Rate (scrolling command)	Number, from 0 to 2, describing the scrolling rate. 0 is off (default); the PS= command is displayed when DPSR=0 is used. 1 is slow; the DPS string will scroll at a rate of approximately 10 s. 2 is fast; the DPS string will scroll at a rate of approximately 3 s. Example: DPSR=2
DPSM=	Dynamic Program Service Mode (scrolling command)	Number, 0 or 1, describing the scrolling mode. 0 is word-scrolling; the DPS string will scroll word by word, or multiple words when they fit. 1 is character-scrolling; the DPS string will scroll character by character. Example: DPSM=0
REV	Software Version (special command)	Typing this command (no = or ?) returns the current RDS encoder software version. Example: REV // issue version command Nautel NVE RDS Encoder V1.0 // exciter response

Figure 3.2.41: Presets page - Other Settings tab (upper, middle and lower sections)

Presets: * Current Settings 

General	Main Audio	SCA	RDS	Other Settings
Pilot Level		9.0	%	
Pilot 1PPS Sync		Enabled		
Pilot Sync Phase		0	°	
Sample Output		Pilot		
Audio Delay		Enabled		
Audio Delay		0.000	ms	
Auto Changeover Action				
Mod Loss Timeout		Enabled		
Action		None		
Timeout Minutes		0	min	
Timeout Seconds		5.0	sec	
Threshold		0	%	

UPPER SECTION

Presets: * Current Settings 

General	Main Audio	SCA	RDS	Other Settings
Hard Limiter		Enabled		
Hard Limit		160	%	
AGC Limiter		Enabled		
AGC Limit		120	%	
Time Constant		300	ms	
Two Slope Limiter		Enabled		
Threshold		160	%	
Gain		50.0	%	
Orban Processor		Enabled		
Orban Preset				
L/R Limiter		Enabled		
Max Gain		12.0	dB	

MIDDLE SECTION

Presets: * Current Settings 

General	Main Audio	SCA	RDS	Other Settings
Time Constant		300	ms	
Two Slope Limiter		Enabled		
Threshold		160	%	
Gain		50.0	%	
Orban Processor		Enabled		
Orban Preset				
L/R Limiter		Enabled		
Max Gain		12.0	dB	
Decay Time		5.000	s	
Hold Time		5.000	s	
MPX Power Limiter		Enabled		
MPX RMS Limit		0.0	dBr	

LOWER SECTION

Other Settings - (see [Figure 3.2.41](#)):

- Other Settings: Provides the following sub-functionality:
 - ❖ Pilot Level: enter value between 6 and 12% (typically 9%). This level is added to the composite baseband signal.
 - ❖ Pilot 1 PPS Sync: select Enabled or Disabled.
 - ❖ Pilot Sync Phase: if Pilot 1 PPS Sync is enabled, enter value between 0 and 360 degrees (typically 0 degrees).

NOTE: *The Pilot Level, Pilot 1 PPS and Pilot Sync Phase settings are displayed for all Audio Source selections, but will have no effect on presets with MPX or MPX Over AES sources.*

- ❖ Sample Output: determines which sample signal will be present on exciter's rear panel PILOT/MPX SAMPLE OUT BNC connector. Select Pilot (default setting, pilot sample present) or MPX (Composite) (composite baseband signal present).
- ❖ Audio Delay: select Enabled, then enter value in the allowable range of 0 to 12,000 ms. Default is 0. Audio Delay is used to time align the receiver output of decoded analog and digital audio signals.
- ❖ Mod Loss Timeout: select Enabled or Disabled, as required. If Enabled is selected, the following sub-fields will appear:
 - Action: Alarm only (no resulting action), RF Inhibit (inhibits the RF output and fans until the audio returns) or Change Preset (changes the active preset).
 - Mod Loss Preset: displayed only if Action is set to Change Preset. Select the preset from the drop down list that will activate upon the loss of a modulating signal, post the timeout period.
 - Timeout Minutes: sets the delay, in minutes, between modulation loss detection and the resulting action. Enter a value in the allowable range of 0 and 255 minutes.
 - Timeout Seconds: sets the delay, in seconds, between modulation loss detection and the resulting action. Enter a value in the allowable range of 0 and 59.9 seconds.
 - Threshold: sets the threshold for modulation loss detection. Enter a value in the allowable range of 0 and 100%. (see [Changing the OS Password on page 3.4.4](#) for detailed instructions).
- ❖ Hard Limiter: select Enabled, then enter the hard limit threshold percentage (allowable range is 0-160%, defaulted to 140%). If enabled, the modulation level will be limited (audio signal clipped or distorted) if it exceeds the hard limit threshold.

-
- ❖ AGC Limiter: select Enabled, then enter AGC Limit percentage (allowable range is 0-160%, defaulted to 120%) and Time Constant (allowable range is 0-1000 ms, defaulted to 0 ms). If Enabled, when the modulation level exceeds the AGC Limit, the gain of the audio input will instantly decrease in order to reduce the modulation level below the AGC limit threshold. Recovery from this audio gain reduction is dependent on the Time Constant delay (fast attack, slow recovery). The input signal is briefly distorted by the audio gain reduction when the threshold is exceeded.
 - ❖ Two Slope Limiter: if Enabled, when the modulation level exceeds the Threshold, the gain of the audio input will instantly change according to the gain percentage setting (percentage of the initial gain, that which is below the threshold). The input signal is distorted by the audio gain change.
 - Threshold: allowable range is 0-160%, defaulted to 120%.
 - Gain: allowable range is 0-100%, defaulted to 56.2%.
 - ❖ L/R Limiter: this look-ahead limiter can be applied to the signal immediately before the stereo generator in the exciter. It has a fixed attack time (and corresponding delay) of approximately 1 ms. It can be configured to reduce the signal, if the gain setting is 0 dB or less, or can be used to perform an AGC function and boost quiet sections of the audio if a positive gain setting is used. If Enabled, enter the following parameters:
 - Max Gain: allowable range is -20 to 20 dB, defaulted to 0 dB.
 - Decay Time: allowable range is 0 to 60 s, defaulted to 0 s.
 - Hold Time: allowable range is 0 to 60 s, defaulted to 0 s.

NOTE: *The L/R Limiter settings are displayed for all Audio Source selections, but will have no effect on presets with MPX or MPX Over AES sources.*

- ❖ MPX Power Limiter: if Enabled, enter MPX RMS Limit. This limit allows the broadcast signal to remain in compliance with the MPX power limits as suggested in ITU-R BS.412-9. While the limiter will keep the transmitter in compliance, it is recommended that adjustment to the processing be made in such a way as to minimize the reductions performed by the limiter. Otherwise, the signal will not take advantage of the peak modulation capability available.
 - MPX RMS Limit (allowable range is -12 to 12 dBr, defaulted to 0 s).

Managing Presets - Using the Front Panel

The Select Presets screen (see [Figure 3.2.42](#)) and Edit Presets screen (see [Figure 3.2.43](#)) allow users to view operational data (power level, frequency, mode, program input characteristics), plus create and control preset settings. Users can create up to 62 presets or edit existing presets. This section includes the following topics:

- [Selecting the Active Preset](#)
- [Editing or Creating Presets](#)

Selecting the Active Preset

When you choose Select Preset from the Main Menu (see [Figure 3.2.42](#)) you can select the active preset for transmitter operation.

Figure 3.2.42: Select Preset screen

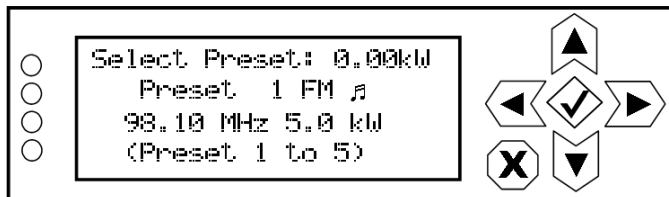

Use the up and down buttons to scroll through the existing presets. Press the accept (checkmark) button to enable the preset as the transmitter’s active preset. Press the cancel (X) button to return to the previous menu.

Editing or Creating Presets

When you select User Settings -> Edit Presets from the Main Menu (see [Figure 3.2.43](#)) you can create up to 63 operating presets or edit existing presets.

Figure 3.2.43: Edit Presets screen

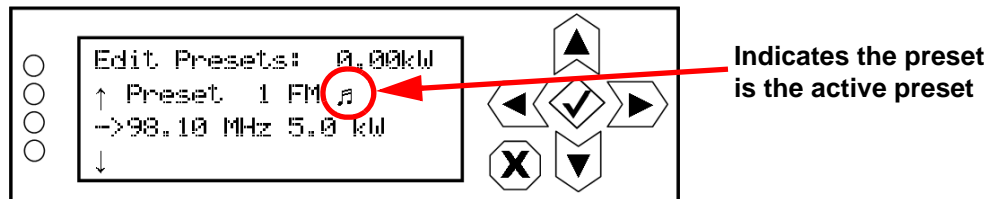

Use the up and down buttons to scroll through the existing presets, or scroll to the bottom of the list to Create New Preset (see [Figure 3.2.44](#)). Press the accept (checkmark) button to enter the editing menu for that preset (see [Figure 3.2.45 on page 3.2.74](#)). Press the cancel (X) button to return to the previous menu. When you create a new preset, the next available preset number is assigned (e.g., Preset 5).

Figure 3.2.44: Create New Preset screen

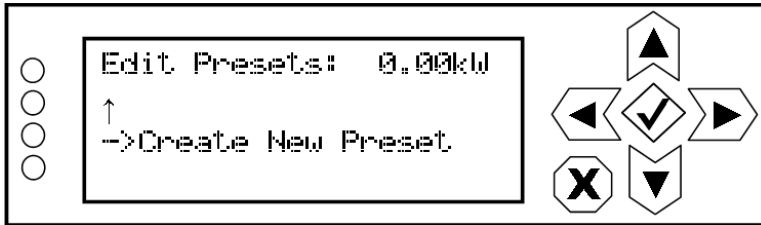
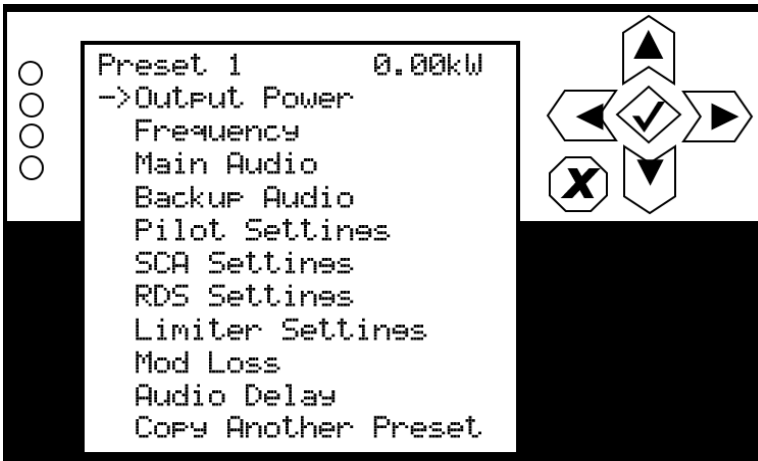

Figure 3.2.45: Preset Editing menu



Within the Preset Editing menu, use the up and down buttons to scroll through the options and press the accept (checkmark) button to enter the selected editing menu/screen. Press the cancel (X) button to return to the previous menu. Parameters that can be edited are:

OUTPUT POWER

The maximum power setting is 22 kW (for NV20LT) or 16.5 kW (for NV15LT) and the minimum power setting is 0.6 kW (600 W) (for both NV20LT and NV15LT). The following exception applies:

- To allow personnel to safely perform antenna tower maintenance, you can operate the NV20LT/ NV15LT below its minimum rated power level. This requires disabling or extraction of RF power modules. See [SECTION 3.4: Non-standard maintenance](#) for a procedure to reduce the output power below the minimum rating.

See [Figure 3.2.46 on page 3.2.75](#). Use the up and down buttons to edit the output power (in 50 W increments), then press the accept (checkmark) button to save the change. Press the cancel (X) button to discard changes and return to the previous menu.

Figure 3.2.46: Output Power screen

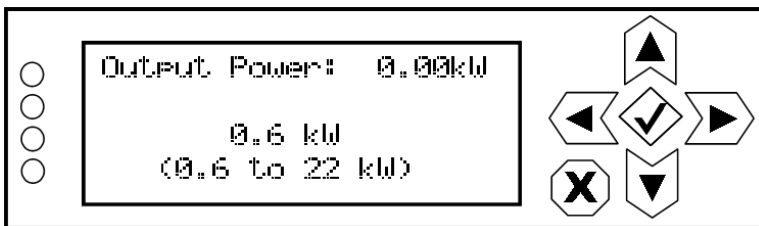

FREQUENCY

See [Figure 3.2.47](#). Use the up and down buttons to edit the carrier frequency (in 0.01 MHz increments), then press the accept (checkmark) button to save the change. Press the cancel (X) button to return to the previous menu.

Figure 3.2.47: Frequency screen

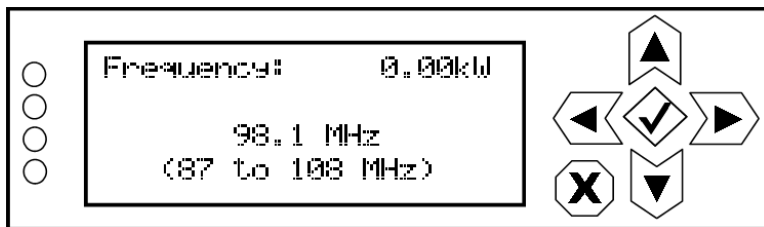

MAIN AUDIO

When you select Main Audio from the Preset editing options screen, you can edit various main audio parameters (see [Figure 3.2.48](#)).

Figure 3.2.48: Main Audio menu



Use the up and down buttons to scroll through the main audio menu options, then press the accept (checkmark) or right arrow button to enter the selected editing screen. [Figure 3.2.49](#) shows the editing screens for the Main Audio menu. Press the cancel (X) button to discard changes and return to the previous menu.

Figure 3.2.49: Main Audio editing screens

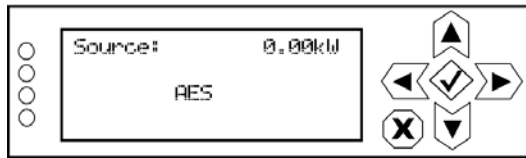

Use the up and down buttons to locate the desired audio source - MPX, Analog L/R, MPX Over AES, Audio Player -> AES 2, Audio Player -> AES 1, AES 2 or AES 1, then press the accept (checkmark) button to save the change. Press the cancel (X) button to discard changes and return to the previous menu.

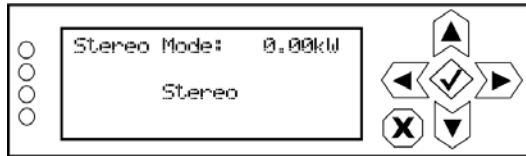

Use the up and down buttons to locate the desired stereo mode - Stereo, Right Mono, Left Mono or L+R Mono then press the accept (checkmark) button to save the change. Press the cancel (X) button to discard changes and return to the previous menu.

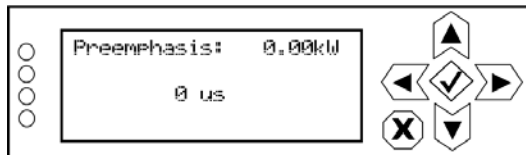

Use the up and down buttons to locate the desired preemphasis characteristic - 0 us, 25 us, 50 us or 75 us, then press the accept (checkmark) button to save the change. Press the cancel (X) button to discard changes and return to the previous menu.

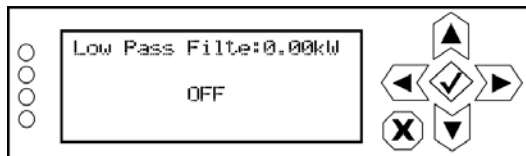

Use the up and down buttons to toggle between ON or OFF, then press the accept (checkmark) button to save the change. Press the cancel (X) button to discard changes and return to the previous menu. Default setting is OFF.

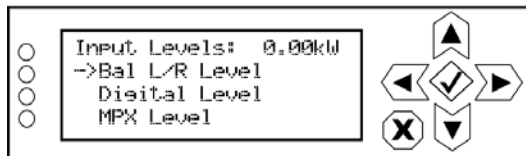

Use the up and down buttons to move the cursor to the desired audio input and then press the right button to enable editing of the parameter. [Figure 3.2.50 on page 3.2.78](#) shows all the editing screens for the Input Levels sub-menu. Within any of the editing screens, use the up and down buttons to edit a parameter value, noting the minimum and maximum limitations indicated at the bottom of the display. When complete, press the accept (checkmark) button to save the change. Press the cancel (X) button to discard changes and return to the previous menu.

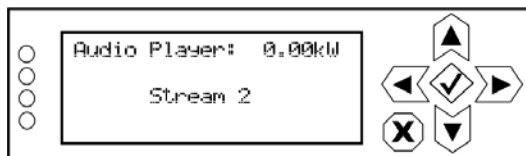

Use the up and down buttons to select File Playlist or Stream 1 through Stream 255, then press the accept (checkmark) button to save the change. Press the cancel (X) button to discard changes and return to the previous menu.

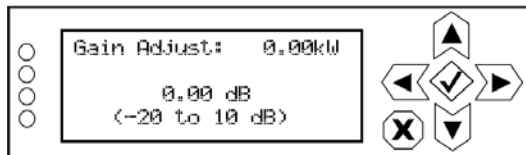

Use the up and down buttons to select again adjust level between -20 and 10 dB (in 0.01 dB increments), then press the accept (checkmark) button to save the change. Press the cancel (X) button to discard changes and return to the previous menu.

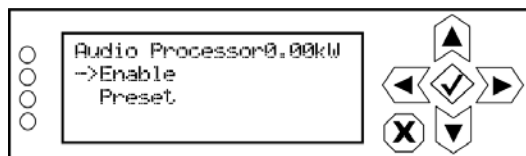

Use the up and down buttons to move the cursor to the desired sub-menu (Enable or Preset) and then press the right button to enable editing within the sub-menu. See [Enabling and Operating the Orban Audio Processor, on page 3.2.182](#) for more details. Press the cancel (X) button to discard changes and return to the previous menu.

Figure 3.2.50: Input Levels editing screens

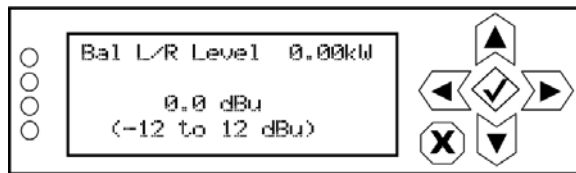

Use the up and down buttons to select a level between -12 and 12 dBu (in 0.1 dBu increments) then press the accept (checkmark) button to save the change. Press the cancel (X) button to discard changes and return to the previous menu. Default level is 0.0 dBu.

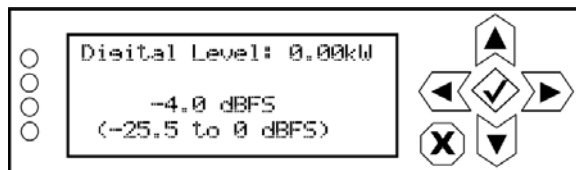

Use the up and down buttons to select a level between -25.5 and 0 dBFS (in 0.1 dBFS increments) then press the accept (checkmark) button to save the change. Press the cancel (X) button to discard changes and return to the previous menu. Default level is -4.0 dBFS.

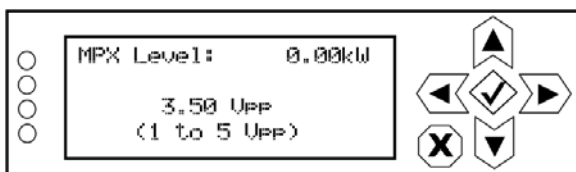

Use the up and down buttons to select a level between 1 and 5 V peak-to-peak (in 0.1 V increments), then press the accept (checkmark) button to save the change. Press the cancel (X) button to discard changes and return to the previous menu. Default level is 3.5 V pp.

BACKUP AUDIO

When you select Backup Audio from the Preset editing options screen, you can enable a backup audio source and edit various backup audio parameters (see [Figure 3.2.51](#)).

Figure 3.2.51: Backup Audio menu

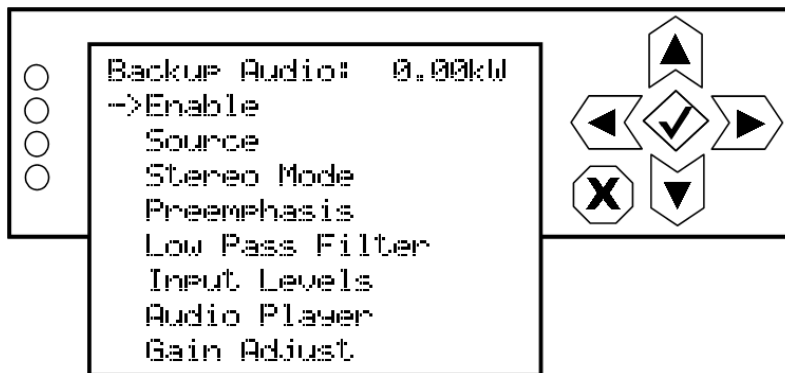

See [Changing the OS Password, on page 3.4.4](#) for limitations on audio backup settings.

Use the up and down buttons to scroll through the backup audio menu options, then press the accept (checkmark) or right arrow button to enter the selected editing screen. With the exception of the Enable screen (select ON to enable, OFF to disable), the editing screens for the Backup Audio menu are the same as the Main Audio menu (see [Figure 3.2.49](#)). Press the cancel (X) button to discard changes and return to the previous menu.

PILOT SETTINGS

When you select Pilot Settings from the Preset editing options screen, you can edit the settings of the pilot signal (see [Figure 3.2.52](#)).

Figure 3.2.52: Pilot Settings menu

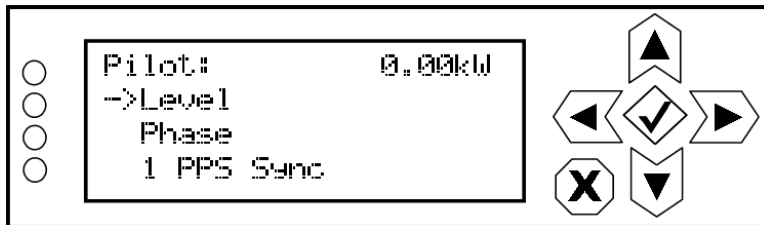

Use the up and down buttons to move the cursor to the desired pilot setting and then press the right button to enable editing of the parameter. [Figure 3.2.53](#) shows all the editing screens for the Pilot Settings menu. Within any of the editing screens, use the up and down buttons to edit or toggle a parameter value, noting the minimum and maximum limitations indicated at the bottom of the display. When complete, press the accept (checkmark) button to save the change. Press the cancel (X) button to discard changes and return to the previous menu.

Figure 3.2.53: Pilot Settings editing screens

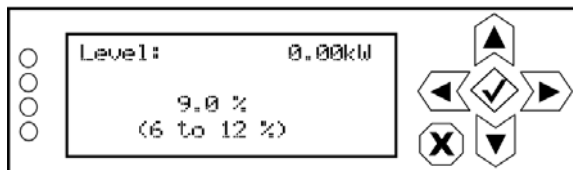

Use the up and down buttons to select a level between 6 and 12% (in 0.1% increments), then press the accept (checkmark) button to save the change. Press the cancel (X) button to discard changes and return to the previous menu. Default level is 9%.

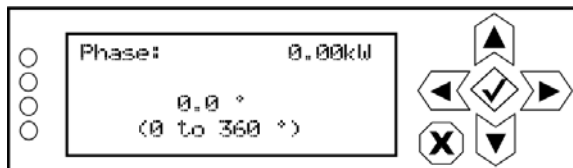

Use the up and down buttons to select a phase angle between 0 and 360 degrees (in 0.1 degree increments), then press the accept (checkmark) button to save the change. Press the cancel (X) button to discard changes and return to the previous menu. Default level is 0.0 degrees.

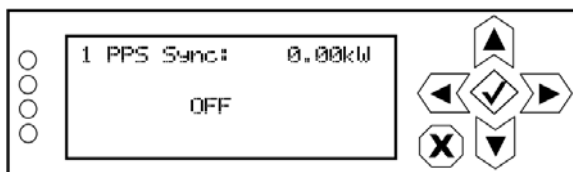

Use the up and down buttons to select ON or OFF, then press the accept (checkmark) button to save the change. Press the cancel (X) button to discard changes and return to the previous menu. Default setting is OFF.

SCA SETTINGS

When you select SCA Settings from the Preset editing options screen, you can edit various SCA parameters (see [Figure 3.2.54](#)).

Figure 3.2.54: SCA Settings menu

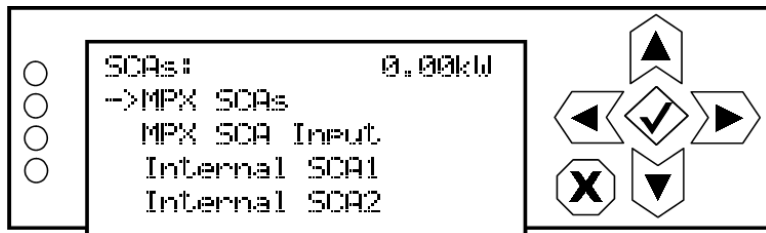

Use the up and down buttons to move the cursor to the desired SCA setting and then press the right button to enable editing of the parameter. [Figure 3.2.55](#) shows the editing screens for the SCA Settings menu. Within any of the editing screens, use the up and down buttons to edit or toggle a parameter value, noting the minimum and maximum limitations indicated at the bottom of the display. When complete, press the accept (checkmark) button to save the change. Press the cancel (X) button to discard changes and return to the previous menu.

If you select Internal SCA1 or Internal SCA2, there is a sub-menu that contains additional SCA settings (see [Figure 3.2.56 on page 3.2.81](#)).

Figure 3.2.55: SCA Settings editing screens

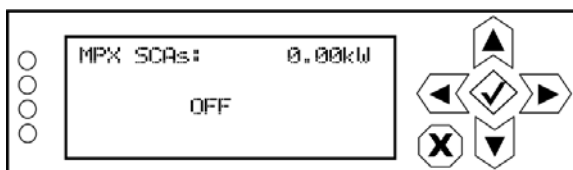

Use the up and down buttons to select ON or OFF, then press the accept (checkmark) button to save the change. Press the cancel (X) button to discard changes and return to the previous menu. Default setting is OFF.

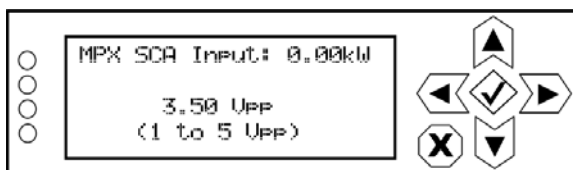

Use the up and down buttons to select a level between 1 and 5 V peak-to-peak (in 0.01 V increments), then press the accept (checkmark) button to save the change. Press the cancel (X) button to discard changes and return to the previous menu. Default level is 3.5 V pp.

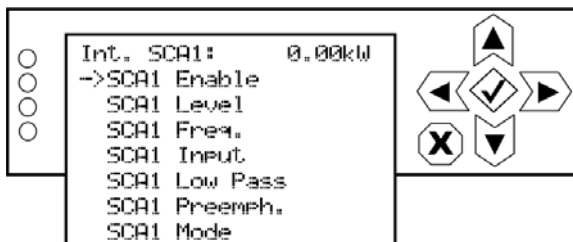

Use the up and down buttons to select the desired parameter for editing. See [Figure 3.2.56 on page 3.2.81](#) for more details. Press the accept (checkmark) button to enter the sub-menu for that parameter. Press the cancel (X) button to return to the previous menu.

Figure 3.2.56: Internal SCA1 and SCA2 editing screens

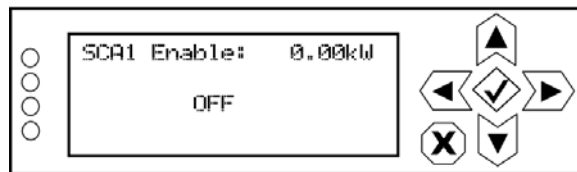

Use the up and down buttons to select ON or OFF, then press the accept (checkmark) button to save the change. Press the cancel (X) button to discard changes and return to the previous menu. Default setting is OFF.

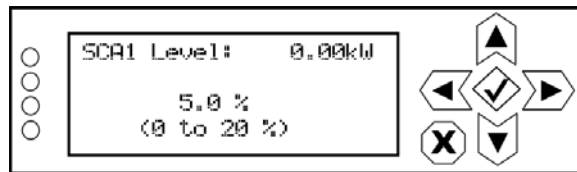

Use the up and down buttons to select a level between 0 and 20%, then press the accept (checkmark) button to save the change. Press the cancel (X) button to discard changes and return to the previous menu. Default level is 5.0%.

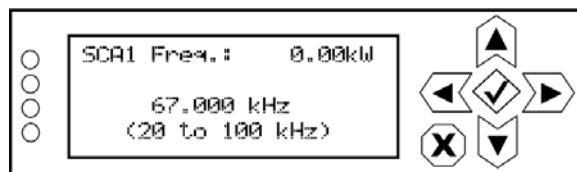

Use the up and down buttons to select a frequency between 20 and 100 kHz, then press the accept (checkmark) button to save the change. Press the cancel (X) button to discard changes and return to the previous menu. Default level is 67 kHz; typical setting is 67 kHz or 92 kHz.

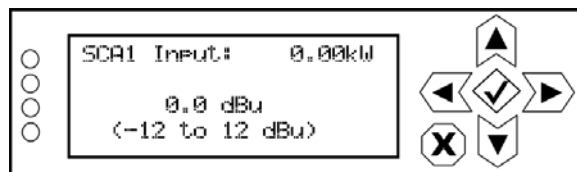

Use the up and down buttons to select a level between -12 and 12 dBu, then press the accept (checkmark) button to save the change. Press the cancel (X) button to discard changes and return to the previous menu. Default level is 0 dBu.

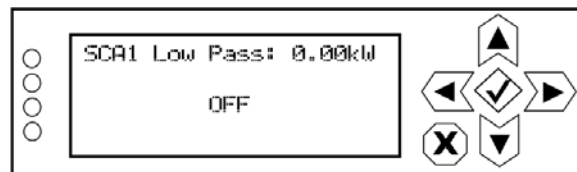

Use the up and down buttons to select ON or OFF, then press the accept (checkmark) button to save the change. Press the cancel (X) button to discard changes and return to the previous menu. Default setting is OFF.

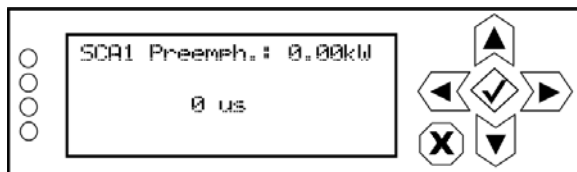

Use the up and down buttons to select a pre-emphasis of 0 us, 50 us, 75 us or 150 us, then press the accept (checkmark) button to save the change. Press the cancel (X) button to discard changes and return to the previous menu. Default level is 0 us.

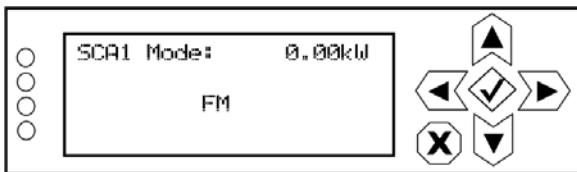

Use the up and down buttons to select FM or DSB-SC, then press the accept (checkmark) button to save the change. Press the cancel (X) button to discard changes and return to the previous menu. Default setting is FM.

RDS SETTINGS

When you select RDS Settings from the Preset editing options screen, you can edit various RDS parameters (see [Figure 3.2.57](#)).

Figure 3.2.57: RDS Settings menu

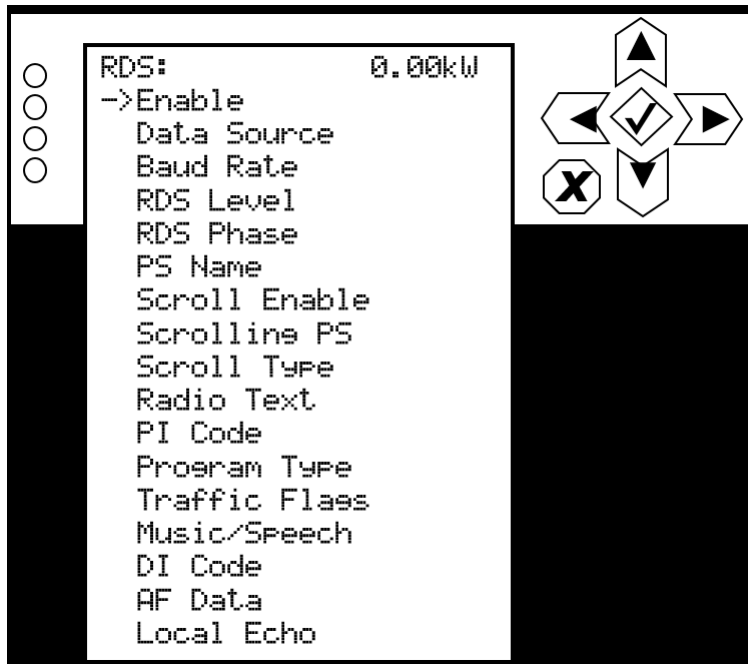

Use the up and down buttons to move the cursor to the desired RDS setting and then press the right button to enable editing of the parameter. [Figure 3.2.58 on page 3.2.83](#) and [Figure 3.2.59 on page 3.2.84](#) show all the editing screens for the RDS Settings menu. Within any of the editing screens, use the arrow buttons to edit or toggle a parameter value, noting the minimum and maximum limitations indicated at the bottom of the display (as applicable). When complete, press the accept (checkmark) button to save the change. Press the cancel (X) button to discard changes and return to the previous menu.

If you select DI Code (see [Figure 3.2.61 on page 3.2.86](#)) or AF Data (see [Figure 3.2.62 on page 3.2.86](#)), there are associated sub-menus that contain additional setting options.

Figure 3.2.58: RDS Settings editing screens (1 of 3)

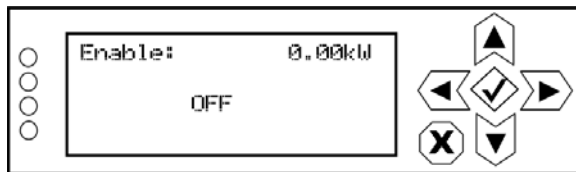

Use the up and down buttons to select ON or OFF, then press the accept (checkmark) button to save the change. Press the cancel (X) button to discard changes and return to the previous menu. Default setting is OFF.

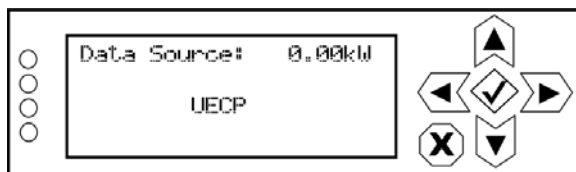

Use the up and down buttons to select Select Internal, Ext. ASCII, Ext. UECP, ASCII Over IP, or UECP Over IP, then press the accept (checkmark) button to save the change. Press the cancel (X) button to discard changes and return to the previous menu. Default setting is UECP.

NOTE: For an ASCII Over IP data source, RDS information should be sent to the IP address of the NV20LT/NV15LT, port 7005.

NOTE: For title/artist functionality, the NV20LT/NV15LT supports the radiotext (RT) data type, using the UECP or Ext. ASCII data source.

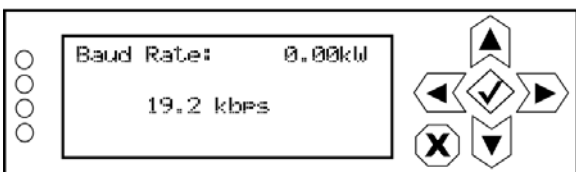

Use the up and down buttons to select Select 150 bps, 300 bps, 600 bps, 1.2 kbps, 2.4 kbps, 4.8 kbps, 9.6 kbps, 19.2 kbps, 38.4 kbps, 57.6 kbps or 115.2 kbps, then press the accept (checkmark) button to save the change. Press the cancel (X) button to discard changes and return to the previous menu. Default baud rate is 19.2 kbps.

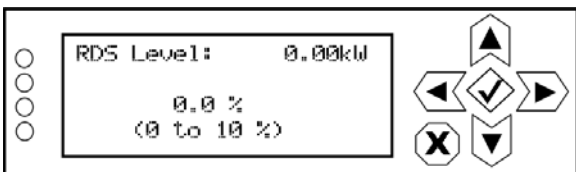

Use the up and down buttons to select a level between 0 and 10% (in 0.1% increments), then press the accept (checkmark) button to save the change. Press the cancel (X) button to discard changes and return to the previous menu. Default level is 0.0%.

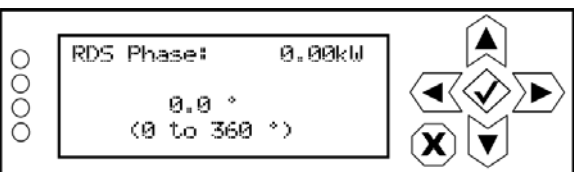

Use the up and down buttons to select a phase angle between 0 and 360 degrees (in 0.1 degree increments), then press the accept (checkmark) button to save the change. Press the cancel (X) button to discard changes and return to the previous menu. Default level is 0.0 degrees.

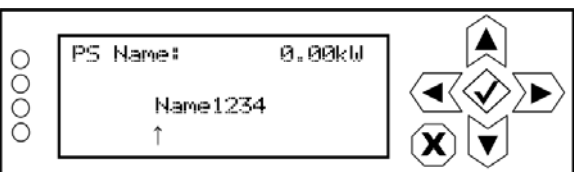

Enter an 8-character name. Use the right and left arrows to move the cursor to the desired character. Use the up and down arrows to edit the character, then press the accept (checkmark) button to save the change. Press the cancel (X) button to discard changes and return to the previous menu.

Figure 3.2.59: RDS Settings editing screens (2 of 3)



Use the up and down arrows to select Off, Fast or Slow, then press the accept (checkmark) button to save the change. Press the cancel (X) button to discard changes and return to the previous menu. The default selection is Off.

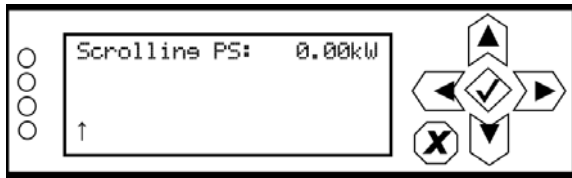

Enter a name. Use the right and left arrows to move the cursor to the desired character. Use the up and down arrows to edit the character, then press the accept (checkmark) button to save the change. Press the cancel (X) button to discard changes and return to the previous menu.

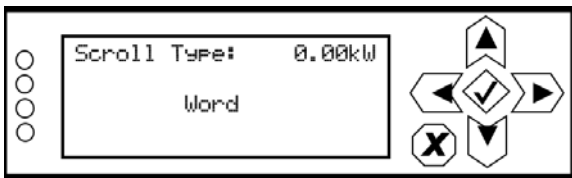

Use the up and down arrows to select Word or Character, then press the accept (checkmark) button to save the change. Press the cancel (X) button to discard changes and return to the previous menu. The default selection is Word.

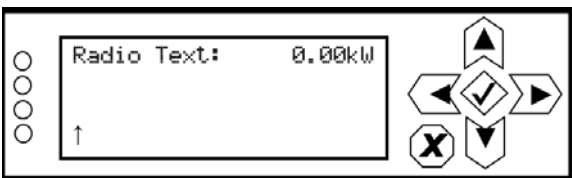

Enter a name. Use the right and left arrows to move the cursor to the desired character. Use the up and down arrows to edit the character, then press the accept (checkmark) button to save the change. Press the cancel (X) button to discard changes and return to the previous menu.



Use the up and down arrows to select a hex value between 0x0000 and 0xFFFF, then press the accept (checkmark) button to save the change. Press the cancel (X) button to discard changes and return to the previous menu. The default hex value is 0x0000.



Use the up and down arrows to select the program type from the various options, then press the accept (checkmark) button to save the change. Press the cancel (X) button to discard changes and return to the previous menu. The default selection is NONE.

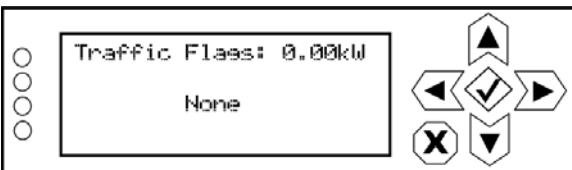

Use the up and down arrows to select None, TA/TP, TP or TA, then press the accept (checkmark) button to save the change. Press the cancel (X) button to discard changes and return to the previous menu. The default selection is NONE.

Figure 3.2.60: RDS Settings editing screens (3 of 3)

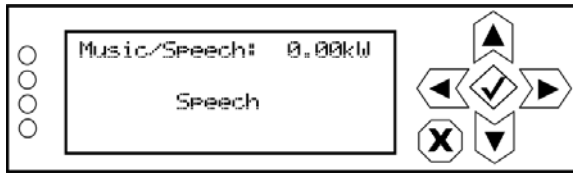

Use the up and down arrows to select Music or Speech, then press the accept (checkmark) button to save the change. Press the cancel (X) button to discard changes and return to the previous menu. The default selection is Speech.

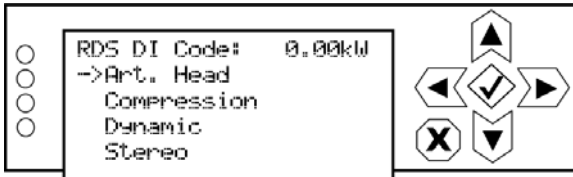

Use the up and down buttons to select the desired parameter for editing. See [Figure 3.2.61 on page 3.2.86](#) for more details. Press the accept (checkmark) button to enter the sub-menu for that parameter. Press the cancel (X) button to return to the previous menu.

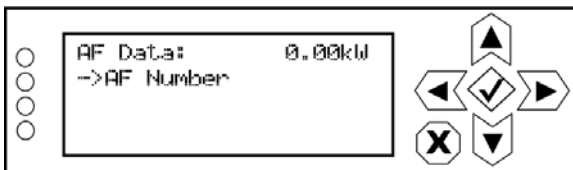

Use the up and down buttons to select AF Number for editing. See [Figure 3.2.62 on page 3.2.86](#) for more details. Press the accept (checkmark) button to enter the sub-menu for that parameter. Press the cancel (X) button to return to the previous menu.

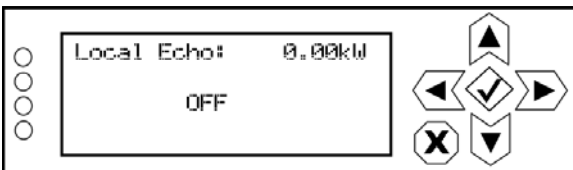

Use the up and down arrows to select ON or OFF, then press the accept (checkmark) button to save the change. Press the cancel (X) button to discard changes and return to the previous menu. The default selection is OFF.

Figure 3.2.61: DI Code editing screens

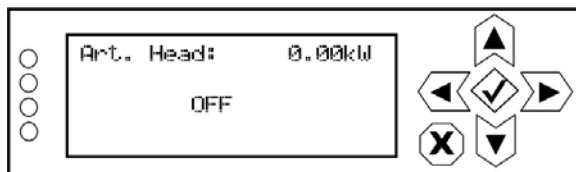

Use the up and down arrows to select ON or OFF, then press the accept (checkmark) button to save the change. Press the cancel (X) button to discard changes and return to the previous menu. The default selection is OFF.

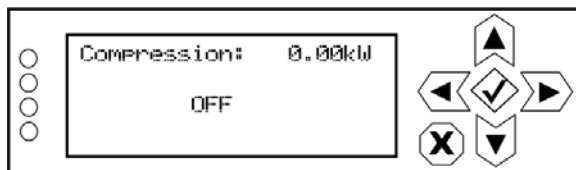

Use the up and down arrows to select ON or OFF, then press the accept (checkmark) button to save the change. Press the cancel (X) button to discard changes and return to the previous menu. The default selection is OFF.

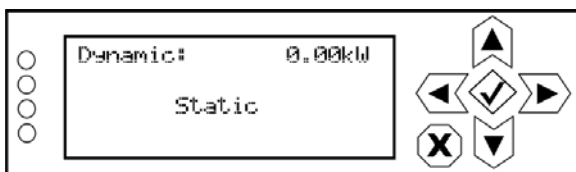

Use the up and down arrows to select Dynamic or Static, then press the accept (checkmark) button to save the change. Press the cancel (X) button to discard changes and return to the previous menu. The default selection is Static.

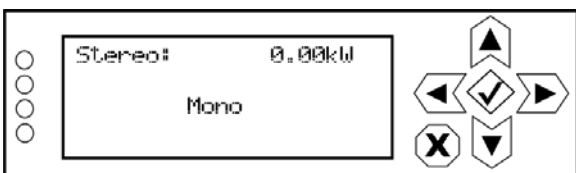

Use the up and down arrows to select Stereo or Mono, then press the accept (checkmark) button to save the change. Press the cancel (X) button to discard changes and return to the previous menu. The default selection is Mono.

Figure 3.2.62: AF Data editing screen

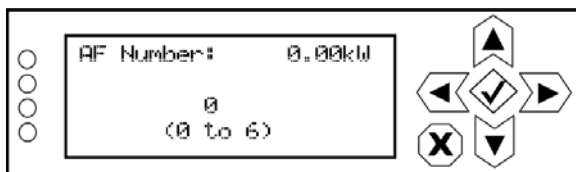

Use the up and down arrows to select the number of alternate frequencies (between 0 and 6), then press the accept (checkmark) button to save the change. Press the cancel (X) button to discard changes and return to the previous menu. The default number is 0.

LIMITER SETTINGS

When you select Limiter Settings from the Preset editing options screen, you can edit various limiter parameters (see [Figure 3.2.63](#)).

Figure 3.2.63: Limiter Settings menu

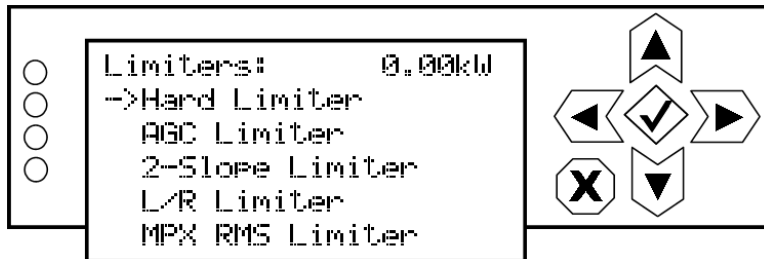

Use the up and down buttons to move the cursor to the desired limiter and then press the right button to enter the associated sub-menu for:

- ❖ Hard Limiter (see [Figure 3.2.64 on page 3.2.88](#))
- ❖ AGC Limiter (see [Figure 3.2.65 on page 3.2.88](#))
- ❖ 2-Slope Limiter (see [Figure 3.2.66 on page 3.2.89](#))
- ❖ L/R Limiter (see [Figure 3.2.67 on page 3.2.90](#))
- ❖ MPX RMS Limiter (see [Figure 3.2.68 on page 3.2.91](#))

Within a sub-menu, use the up and down buttons to move the cursor to the desired limiter setting and then press the right button to enter the associated editing screen. Within any of the editing screens, use the arrow buttons to edit or toggle a parameter value, noting the minimum and maximum limitations indicated at the bottom of the display (as applicable). When complete, press the accept (checkmark) button to save the change. Press the cancel (X) button to discard changes and return to the previous menu.

Figure 3.2.64: Hard Limiter sub-menu and editing screens

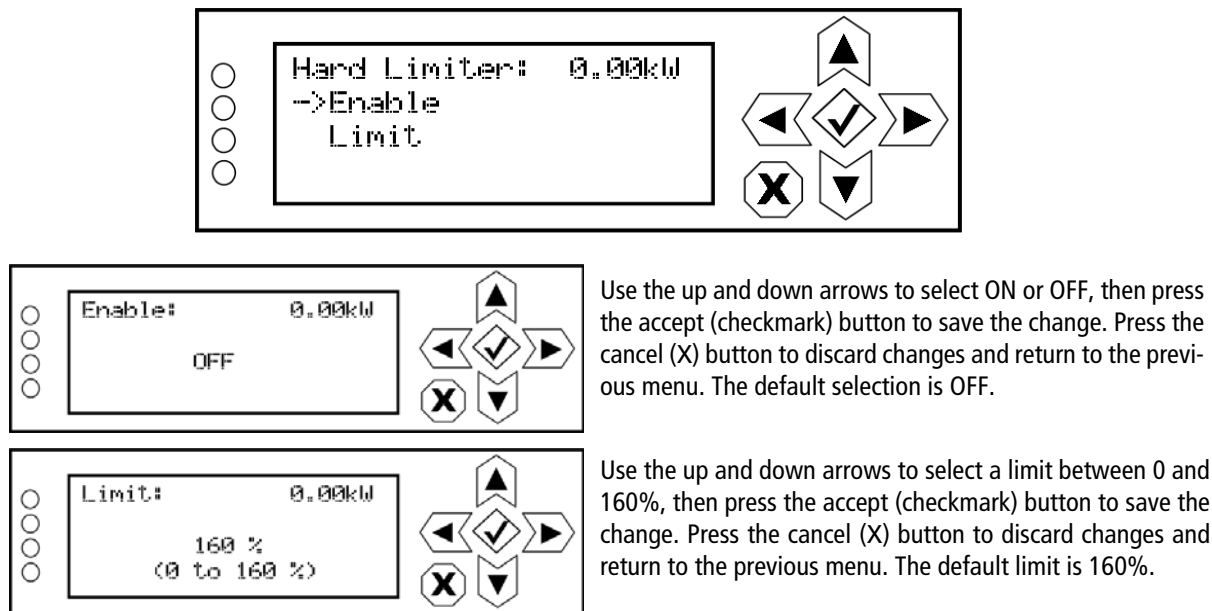

Figure 3.2.65: AGC Limiter sub-menu and editing screens

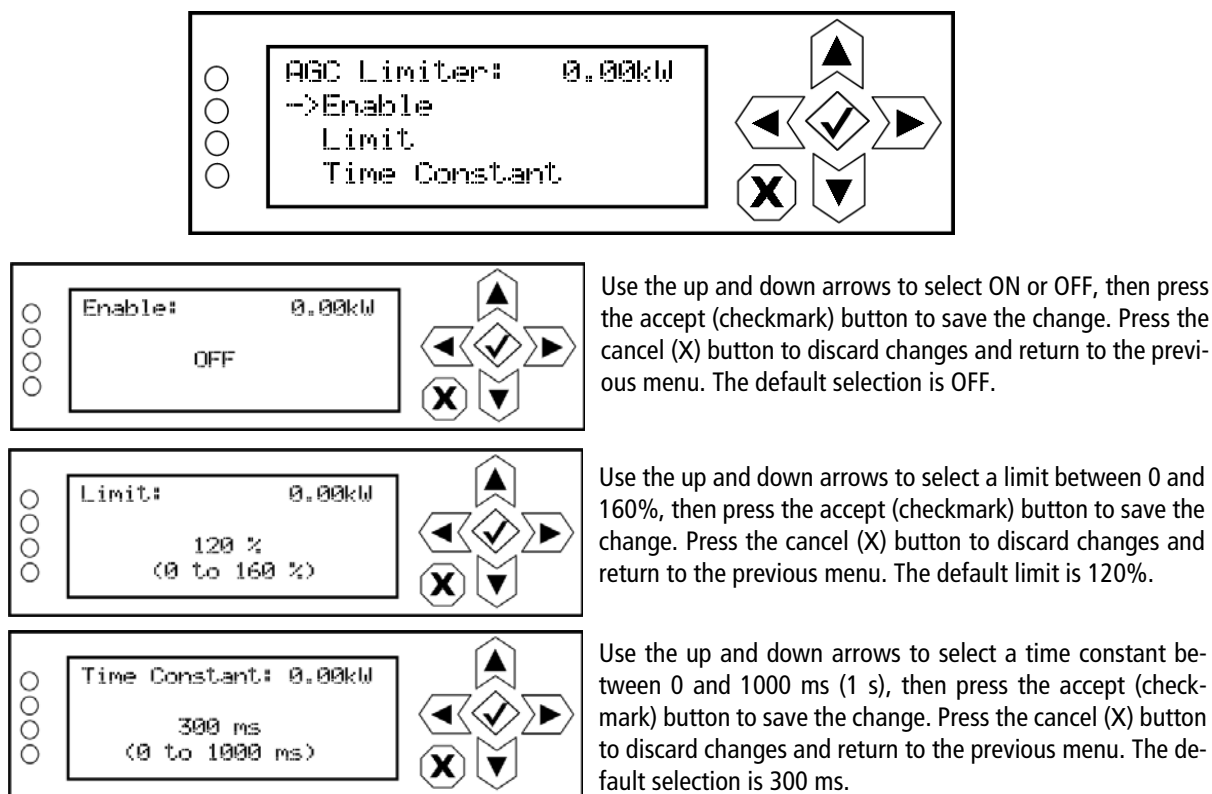
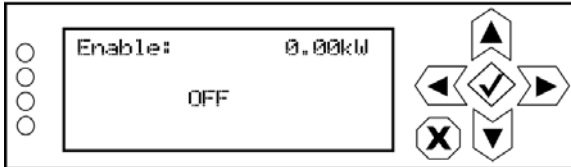
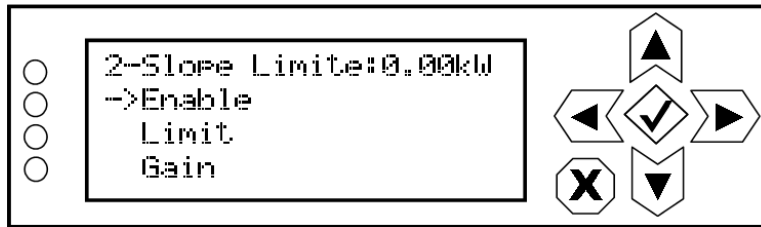
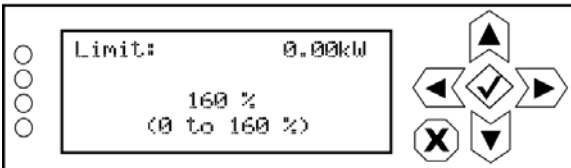

Figure 3.2.66: 2-Slope Limiter sub-menu and editing screens



Use the up and down arrows to select ON or OFF, then press the accept (checkmark) button to save the change. Press the cancel (X) button to discard changes and return to the previous menu. Default selection is OFF.



Use the up and down arrows to select a limit between 0 and 160%, then press the accept (checkmark) button to save the change. Press the cancel (X) button to discard changes and return to the previous menu. Default limit is 160%.

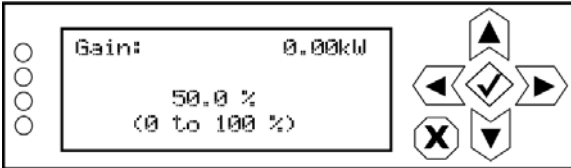

Use the up and down arrows to select a gain between 0 and 100%, then press the accept (checkmark) button to save the change. Press the cancel (X) button to discard changes and return to the previous menu. Default gain is 50%.

Figure 3.2.67: L/R Limiter sub-menu and editing screens

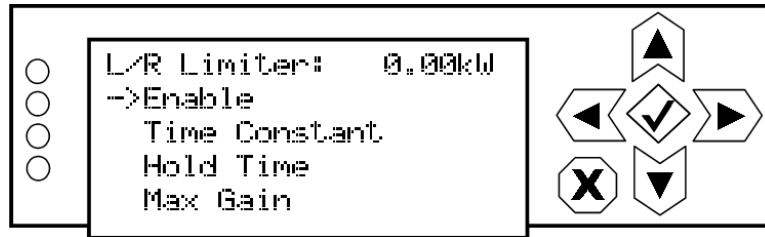

Use the up and down arrows to select ON or OFF, then press the accept (checkmark) button to save the change. Press the cancel (X) button to discard changes and return to the previous menu. Default selection is OFF.

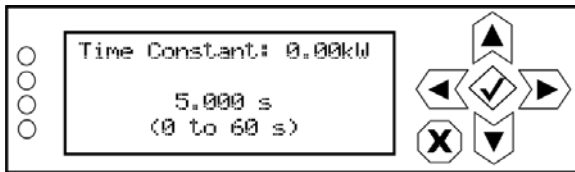

Use the up and down arrows to select a time constant between 0 and 60 s, then press the accept (checkmark) button to save the change. Press the cancel (X) button to discard changes and return to the previous menu. Default time constant is 5.000 s.

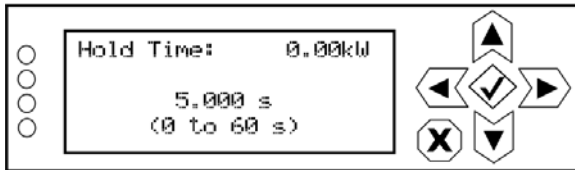

Use the up and down arrows to select a hold time between 0 and 60 s, then press the accept (checkmark) button to save the change. Press the cancel (X) button to discard changes and return to the previous menu. Default hold time is 5.000 s.

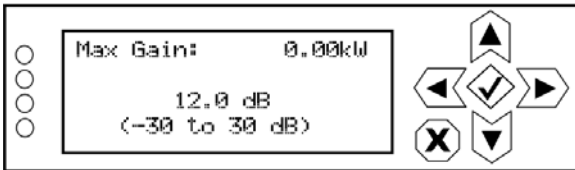

Use the up and down arrows to select a maximum gain between -30 and 30 dB, then press the accept (checkmark) button to save the change. Press the cancel (X) button to discard changes and return to the previous menu. Default gain is 12.0 dB.

Figure 3.2.68: MPX RMS Limiter sub-menu and editing screens

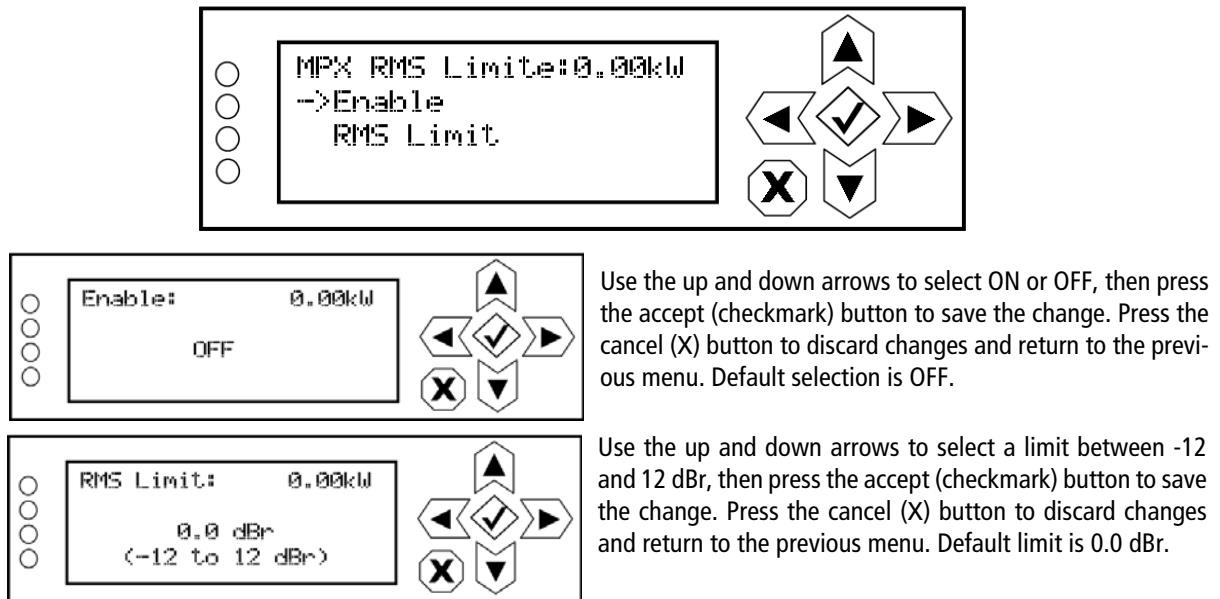

MOD Loss

When you select Mod Loss (modulation loss) from the Preset editing options screen, you can edit the parameters related to a loss of modulation (see [Figure 3.2.69](#)).

Figure 3.2.69: Mod Loss menu

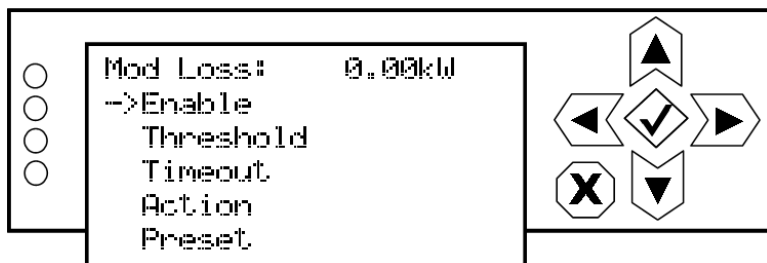

Use the up and down buttons to move the cursor to the desired mod (modulation) loss menu item and then press the right button to enable editing of the item. [Figure 3.2.70](#) shows all the editing screens for the Mod Loss menu. Within any of the editing screens, use the up and down buttons to edit a parameter value, noting the minimum and maximum limitations indicated at the bottom of the display (as applicable). When complete, press the accept (checkmark) button to save the change. Press the cancel (X) button to discard changes and return to the previous menu.

See [Changing the OS Password](#), on page 3.4.4 for detailed instructions.

Figure 3.2.70: Mod Loss editing screens

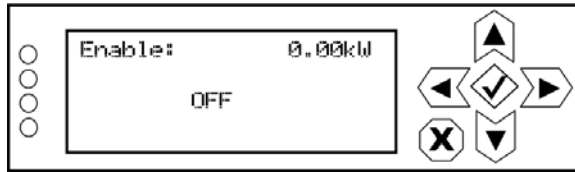

Determines whether the audio loss feature is used. Use the up and down arrows to select ON (enable) or OFF (disable), then press the accept (checkmark) button to save the change. Press the cancel (X) button to discard changes and return to the previous menu. Default selection is OFF.

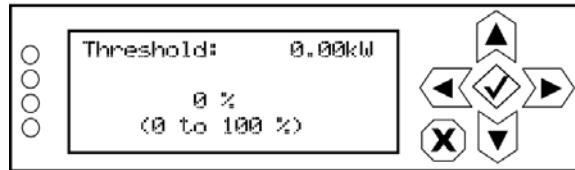

Sets the modulation threshold below which the transmitter will take action. Use the up and down arrows to select a threshold between 0 and 100% (adjustable in 1% steps), then press the accept (checkmark) button to save the change. Press the cancel (X) button to discard changes and return to the previous menu. Default threshold is 0%.

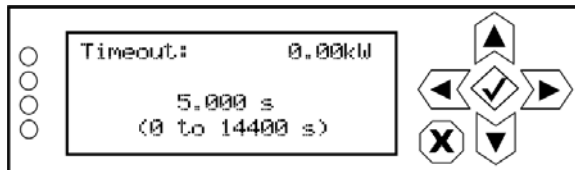

Sets the time period of low modulation (based on the threshold setting) after which the transmitter will take action. Use the up and down arrows to select a value between 0 and 14400 seconds (240 minutes) (in 0.05 s increments), then press the accept (checkmark) button to save the change. Press the cancel (X) button to discard changes and return to the previous menu. Default timeout is 0 s.

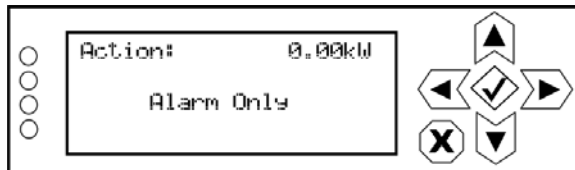

Determines the action taken by the transmitter when the modulation has been below the threshold for the timeout period. Use the up and down arrows to select Alarm Only, Switch Preset or RF Inhibit, then press the accept (checkmark) button to save the change. Press the cancel (X) button to discard changes and return to the previous menu. Default setting is Alarm Only.

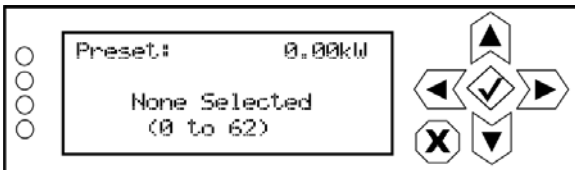

Determines the preset that becomes active after a modulation loss if the mod loss action is set to Switch Preset. Use the up and down arrows to select None Selected or Preset 1 to 62, then press the accept (checkmark) button to save the change. Press the cancel (X) button to discard changes and return to the previous menu. Default setting is None Selected.

AUDIO DELAY

When you select Audio Delay from the Preset editing options screen, you can edit or disable the audio delay period (see [Figure 3.2.71](#)).

Figure 3.2.71: Audio Delay menu

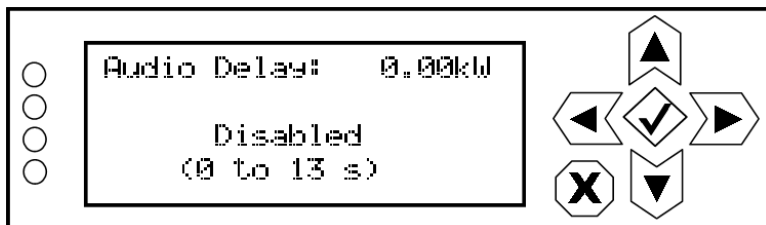

Use the up and down buttons to change the audio delay setting between disabled (= 0 s) and any time period to a maximum of 13 seconds (in 1 us steps), then press the accept (checkmark) button to save the change. Press the cancel (X) button to discard changes and return to the previous menu.

COPY ANOTHER PRESET

When you select Copy Another Preset from the Preset editing options screen, you can copy the settings from another preset into the preset that is being edited (see [Figure 3.2.72](#)).

Figure 3.2.72: Copy Another Preset Screen

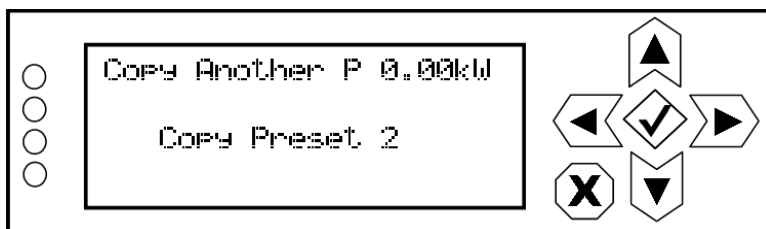

Use the up and down buttons to select the preset that you wish to copy to the selected preset for editing (e.g., Copy Active Preset, Copy Preset 2, etc.) or select Cancel. Press the accept (checkmark) button to save the change. Press the cancel (X) button to discard changes and return to the previous menu.

Resetting Alarms

You can attempt to reset any latching transmitter alarms that are holding the transmitter in an “off-air” state using the remote AUI’s Reset button (see [page 3.2.18](#)) or using the local front panel display (see [Resetting Alarms - Using the Front Panel](#)).

Resetting Alarms - Using the Front Panel

When you select Reset Alarms from the Main Menu, you can attempt to reset latched protection circuits in the NV20LT/NV15LT (see [Figure 3.2.73](#)). If the alarm condition has been cleared, the alarm indication on the View Alarms screen should disappear.

Figure 3.2.73: Reset Alarms Screen

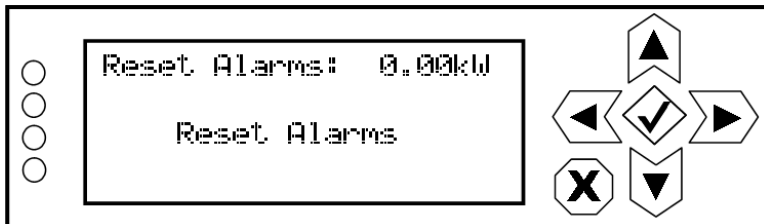

Use the up and down buttons to toggle between Reset Alarms and Cancel. Press the accept (checkmark) button to save the change. Press the cancel (X) button to return to the previous menu.

Viewing Transmitter Status - AUI

You can view the NV20LT/NV15LT’s operational status using the AUI’s [Transmitter Status page](#) - see [Figure 3.2.74](#). This page shows current active alarms to aid in fault diagnosis. To view the [Transmitter Status page](#), click the Status button in the AUI’s bottom banner. Click X to return to the home page.

You can also use the local front panel UI to view active alarms (see [Transmitter Alarms and Log - Using the Front Panel](#), on page 3.2.32).

This section includes the following topics:

- [Viewing Alarm Details](#), on page 3.2.96
- [Status Button Colour Indications](#), on page 3.2.96
- [Resetting Alarms](#), on page 3.2.96

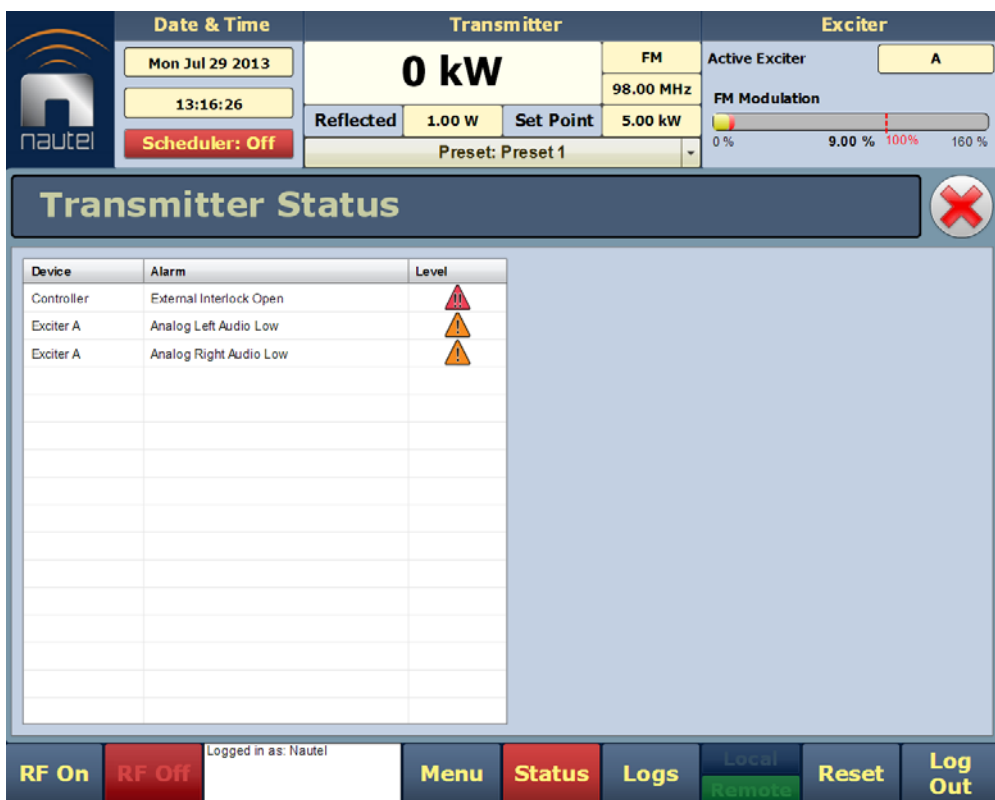

Figure 3.2.74: Transmitter Status page



Viewing Alarm Details

The [Transmitter Status](#) page - see [Figure 3.2.74](#) on [page 3.2.95](#) displays a table that lists the active alarm details under the following columns:

- Device - identifies the alarms by their originating device (e.g., Controller, Exciter A, Rack, etc.)
- Alarm - identifies the type of alarm (alarm name).
- Level - identifies the severity level of the alarm (see below).

-  = low (RF output not affected)
-  = medium (RF output may be reduced)
-  = high (RF output may be inhibited)

NOTE: When viewing alarms, cross-reference the alarm name, (which appears in the Alarm column of the Transmitter Status page) with Table 4.1.1 of the Troubleshooting Manual.

Status Button Colour Indications

- When the Status button is red, one or more active alarms are indicating that the transmitter may be in an 'off-air' state.
- When the Status button is amber, one or more active alarms are indicating that the transmitter is still 'on-air', but may be at reduced power.
- When the Status button is green, no alarms are being reported and the transmitter is operating normally.

Resetting Alarms

When an alarm is present, use the Reset button, at the bottom of any AUI screen, (see [Figure 3.2.75](#)) to clear any latching alarms that are holding the transmitter in an "off-air" state. If the offending alarm has cleared, then the transmitter should resume operation.

Figure 3.2.75: Reset Button



User Settings - AUI

The User Settings page (see [Figure 3.2.76 on page 3.2.98](#)) allows operators to modify various custom user settings such as network and email notifications. To view the User Settings page, select User Settings from the Menu options. Click X in the upper, right corner to close this page and return to the Home page.

The User Settings options include:

- [Network Setup, on page 3.2.98](#) ***
- [Network Setup - Using the AUI, on page 3.2.102](#)
- [Notifications, on page 3.2.105](#)
- [Nautel Phone Home, on page 3.2.107](#)
- [SNMP Configuration, on page 3.2.108](#)
- [Capturing Critical Parameters, on page 3.2.109](#)
- [Using an External 10 MHz Input, on page 3.2.110](#) ***
- [Setting the Clock, on page 3.2.112](#) ***
- [Configuring NTP Servers, on page 3.2.115](#)
- [Setting User Thresholds - see page 3.2.117](#)
- [Setting Call Sign/ID, on page 3.2.119](#)
- [Turn-On Behaviour, on page 3.2.120](#)

*** **NOTE:** The front panel UI also has a User Settings menu, which contains similar functions to the AUI (e.g., network setup, setting the clock, etc.), and additional settings that are described in [User Settings - Front Panel UI, on page 3.2.121](#). Unless otherwise noted, the following functions are only available via a LAN connection to the remote AUI.

Figure 3.2.76: User Settings menu - Network Setup page shown

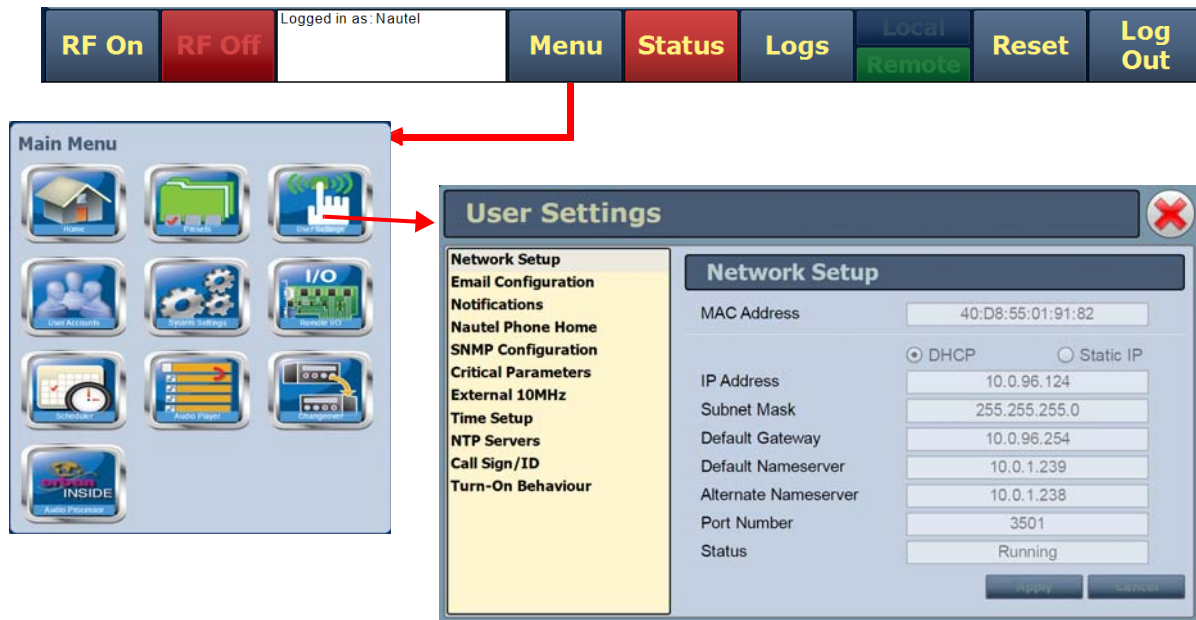

Network Setup

You can configure network settings using the local front panel UI (see [Network Setup - Using the Front Panel](#) or the remote AUI (see [Network Setup - Using the AUI, on page 3.2.102](#)). If you change a network setting on the front panel UI, it will also be reflected on the remote AUI, and vice versa.

NOTE: Nautel recommends that the following network settings be entered/vetted by a qualified Network Administrator. If parameters are changed and the AUI is reset, record the new values (or see the local front panel UI) to ensure you can log in after changes have been made.

Determining DHCP Setting

One of the main decisions in configuring the network connection on your NV20LT/NV15LT transmitter is whether you set DHCP to ON or OFF. If you are connecting to a network, consult with a network administrator before connecting the transmitter to your network to determine whether to enable (turn ON) or disable (turn OFF) the DHCP setting.

When DHCP is set to ON (default from factory), IP addresses are assigned automatically by the network server. In order for this feature to function properly, you must have a network-viewable DHCP server on your network.

If a DHCP server is not present, you (or your network administrator) must provide static addresses for IP, netmask, gateway and nameservers (gateway and nameservers are optional). You must enter them manually using the transmitter's front panel. In this case, DHCP should be set to OFF.

Network Setup - Using the Front Panel

From the transmitter's front panel, in local mode, you can set or change network settings. To view the Network Settings screen, select User Settings -> Network Settings from the Main Menu. See [Figure 3.2.77 on page 3.2.100](#) for details on setting each parameter.

Use the up and down buttons to move the cursor to the desired parameter and then press the right button to enable editing of the setting. Within any of the editing screens, use the left and right buttons to select a character for editing and then use the up and down buttons to edit a setting. Press the accept (checkmark) button to save the change. Press the cancel (X) button to discard changes and return to the previous menu.

NOTE: A nameserver (also called a DNS) translates a host name (e.g., mail.nautel.com) to an IP address such as in configuring email (see [Email Configuration, on page 3.2.103](#)).

If you are using a laptop to connect to the NV20LT/NV15LT, see [Connecting a Laptop Directly to the Transmitter, on page 3.2.101](#).

Figure 3.2.77: Network Settings screens

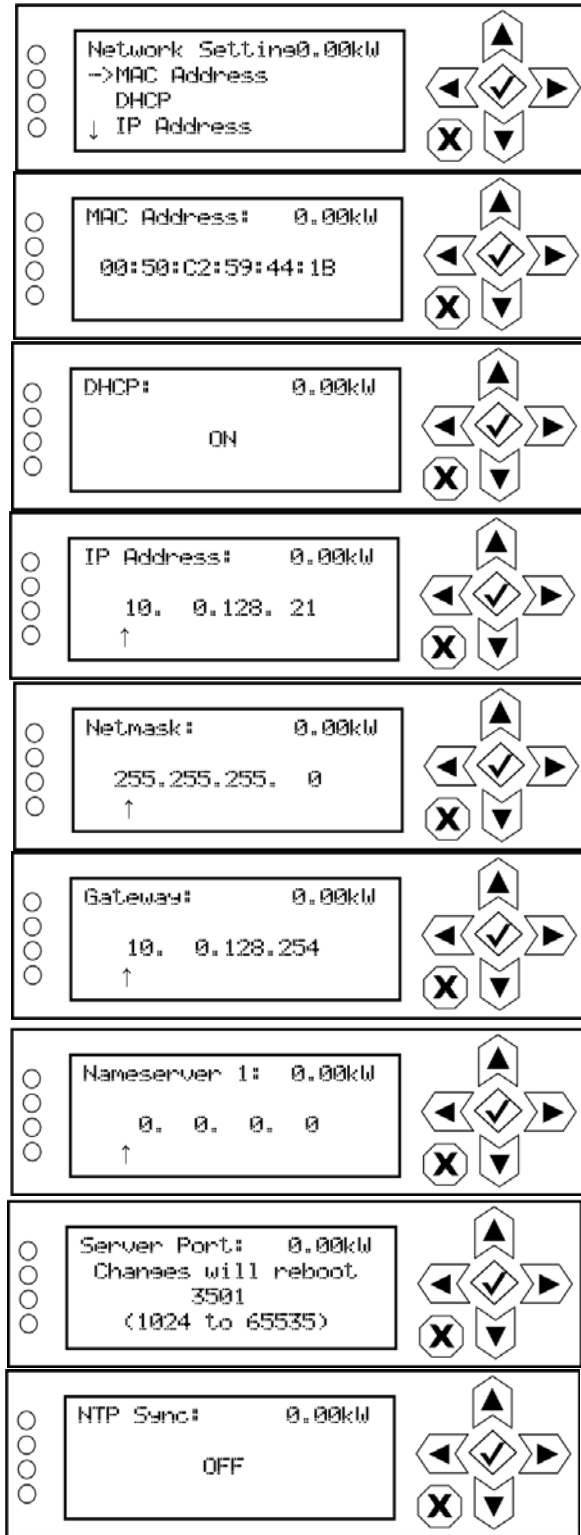

All addresses shown are for reference purposes only

Displays a number that serves as unique network adapter identifier. This is set by the manufacturer and is displayed for informational purposes only (cannot be user set). It may be necessary to use this number to allow the AUI to access your network.

Set to ON to automatically assign the IP Address, Netmask, Gateway, Nameserver 1 and Nameserver 2 by the access point (i.e., a router) or set to OFF to manually assign. In either case, the access point must be configured with the correct settings, which match the settings on the AUI in order for the AUI to access the network.

Displays a unique numerical network identifier for the transmitter. If DHCP was set to OFF, specify the IP address. Consult with your network administrator.

Masks an IP address, and divides the IP address into network address and host address. If DHCP was set to OFF, specify netmask. Typical netmask address shown. Consult with your network administrator.

Displays the address of the network access point. If DHCP was set to OFF, specify the gateway address. Consult with your network administrator.

Address that identifies the DNS host. The DNS (Domain Name System) translates internet domain and host names to IP addresses. DNS automatically converts the name typed into a web browser address bar to the IP addresses of web servers hosting those sites. If DHCP is set to OFF, specify the address.

Used to identify the senders and receivers of messages. Also supports port forwarding (remapping) which allows the AUI of multiple transmitters to be accessed on the same network. See your network router documentation for additional remapping information and instructions. NOTE: Changes to this port are reset to 3501 after a software upgrade; reconfigure the port, as required, after an upgrade.

NTP = Network Time Protocol.
Set to ON to allow the transmitter to synchronize to the network time.
Set to OFF to use the transmitter's internal time reference.

Connecting a Laptop Directly to the Transmitter

If connecting to the NV20LT/NV15LT directly with a laptop, you must set a static IP address on the NV20LT/NV15LT and your laptop.

1. From the front panel UI's Main Menu, go to User Settings -> Network Settings and set the IP address as follows:
 - ❖ DHCP: OFF
 - ❖ IP Address: 10.10.10.2
 - ❖ Netmask: 255.255.255.0
2. Set the transmitter for Remote control.

NOTE: The following steps assume the operating system is Windows XP. Adapt as required for computers with different operating systems.

3. On the laptop, go to Start Menu/Control Panel/Network Connections/Local Area Network.
4. In the Local Area Network Status, open the General tab and choose Properties. Scroll down and highlight Internet Protocol (TCP/IP). Choose Properties.
5. In the Internet Protocol (TCP/IP) Properties window, select Use the following IP address.
6. Enter the following settings:
 - ❖ IP Address: 10.10.10.1
 - ❖ Subnet Mask: 255.255.255.0
 - ❖ Default Gateway: 192.168.1.2
7. In the Internet Protocol (TCP/IP) Properties window, select OK.
8. In the Local Area Connection Properties window, select OK.
9. In the Local Area Connection Status window, select Close.
10. Close the Network Connections window.

Network Setup - Using the AUI

NOTE: Nautel recommends that the following network settings be entered/vetted by a qualified Network Administrator. Refer to [Figure 3.2.77 on page 3.2.100](#) for detailed descriptions of each field.

By entering the NV20LT/NV15LT’s established IP address into an Internet browser’s address bar, and then logging into the AUI, you can view and edit the network parameters (see [Figure 3.2.76 on page 3.2.98](#)). You must have remote control enabled to edit network settings using the remote AUI.

The MAC Address and Status fields are read-only; they cannot be edited.

You must select Static IP to be able to edit the IP Address, Subnet Mask, Default Gateway and Nameserver fields. If you are in DHCP mode, these fields will be assigned automatically.

The Status field identifies the status of the network.

- ❖ Running: transmitter is connected to a network and is functioning properly.
- ❖ Not Running: transmitter is not connected or is not functioning properly. When in this state, remote AUI access is not possible.

Figure 3.2.78: Network Setup page

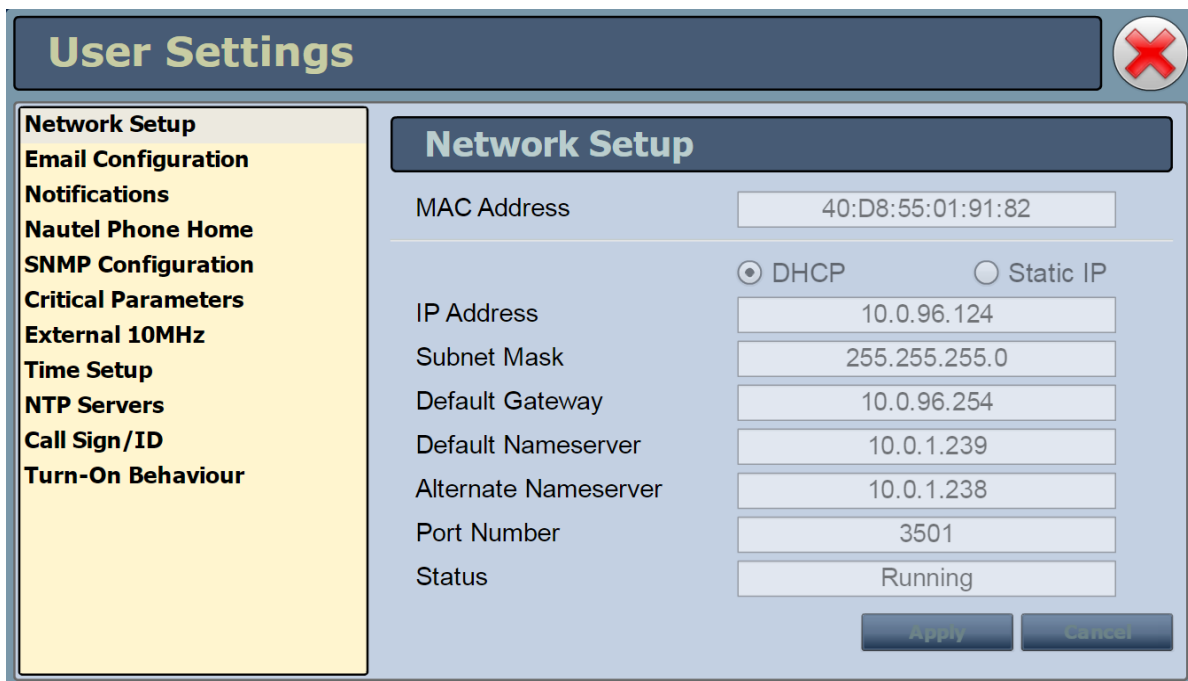

All addresses shown are for reference purposes only

Email Configuration

The Email Configuration page (see [Figure 3.2.79](#)) allows you to configure email parameters (e.g., email server and port number), and is required if the notification feature is used (see [Notifications, on page 3.2.105](#)).

NOTE: Nautel recommends that the following settings be entered/vetted by a qualified Network Administrator.

Figure 3.2.79: Email Configuration page

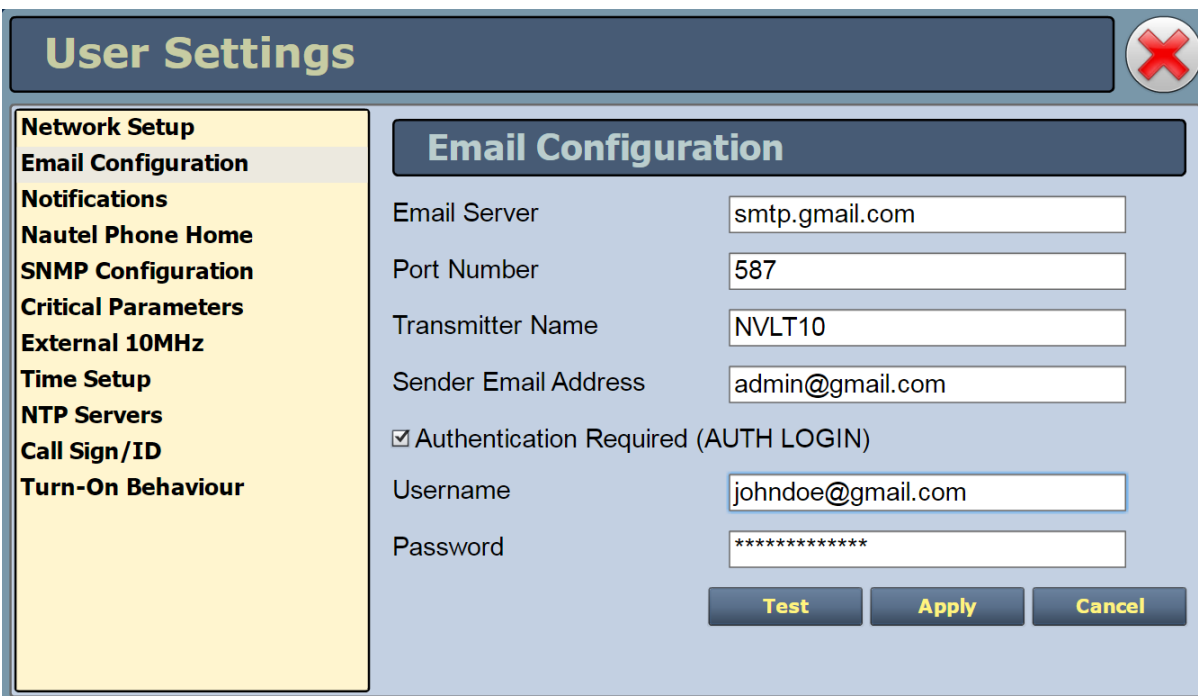

The screenshot shows a web interface titled "User Settings" with a close button (red X) in the top right corner. On the left is a vertical navigation menu with the following items: Network Setup, Email Configuration (highlighted), Notifications, Nautel Phone Home, SNMP Configuration, Critical Parameters, External 10MHz, Time Setup, NTP Servers, Call Sign/ID, and Turn-On Behaviour. The main content area is titled "Email Configuration" and contains the following fields and controls:

Email Server	<input type="text" value="smtp.gmail.com"/>
Port Number	<input type="text" value="587"/>
Transmitter Name	<input type="text" value="NVLT10"/>
Sender Email Address	<input type="text" value="admin@gmail.com"/>
<input checked="" type="checkbox"/> Authentication Required (AUTH LOGIN)	
Username	<input type="text" value="johndoe@gmail.com"/>
Password	<input type="password" value="*****"/>

At the bottom of the form are three buttons: "Test", "Apply", and "Cancel".

To configure the email feature, perform the following steps:

1. Open the User Settings page by clicking Menu -> User Settings in the Home page.
2. Select the Email Configuration option (left-side of the screen) (see [Figure 3.2.79](#)) to display related information and associated parameters on the right-side of the screen.

3. Enter the following parameters:

- ❖ **Email Server:** The outgoing mail server. Enter the server name or IP address here. In order to enter a server name (e.g., mail.nautel.com), at least one nameserver IP address must be entered (see [Network Setup, on page 3.2.98](#)).
- ❖ **Port Number:** This logical connection end point uses a number to identify the type of process to which an internet or other network message is to be forwarded to when it arrives at a server. Typically, this is set to 25 for unencrypted SMTP systems and 843 for encrypted email.
- ❖ **Transmitter Name:** Set to a name that associates to the transmitter such as station identification (e.g., NV10LT_WXYZ). This name will be included in notification emails.
- ❖ **Sender Email Address:** Enter as a standard email address (e.g., a@b.com). This will be the sender address that notification email recipients will see. Free web-based email service accounts (Gmail, Hotmail, Yahoo mail etc.) are acceptable here.
- ❖ **Authentication Required:** If your email server requires authentication to send emails, select the check box and enter the appropriate Username and Password to allow this. If the check box is not selected, the Username and Password fields do not appear.
- ❖ **Username:** Enter the username for your outgoing email server.
- ❖ **Password:** Enter the password for your outgoing email server.

NOTE: The transmitter will automatically handle encryption if the associated mail server requires it.

4. When complete, select Apply or Cancel to restore the previous setting. Use the Test button to enter an address to which an email will be sent to verify your settings. Enter the recipient address and click the OK button to send the test email or click the Cancel button to return to the Email Configuration page.

Notifications

The Notifications page (see [Figure 3.2.80](#)) provides a means for the transmitter to issue emails or texts (SMS messages) triggered by user defined alarm events. If you use this feature, you must also configure an email (see [Email Configuration](#), on page 3.2.103).

Figure 3.2.80: Notifications page

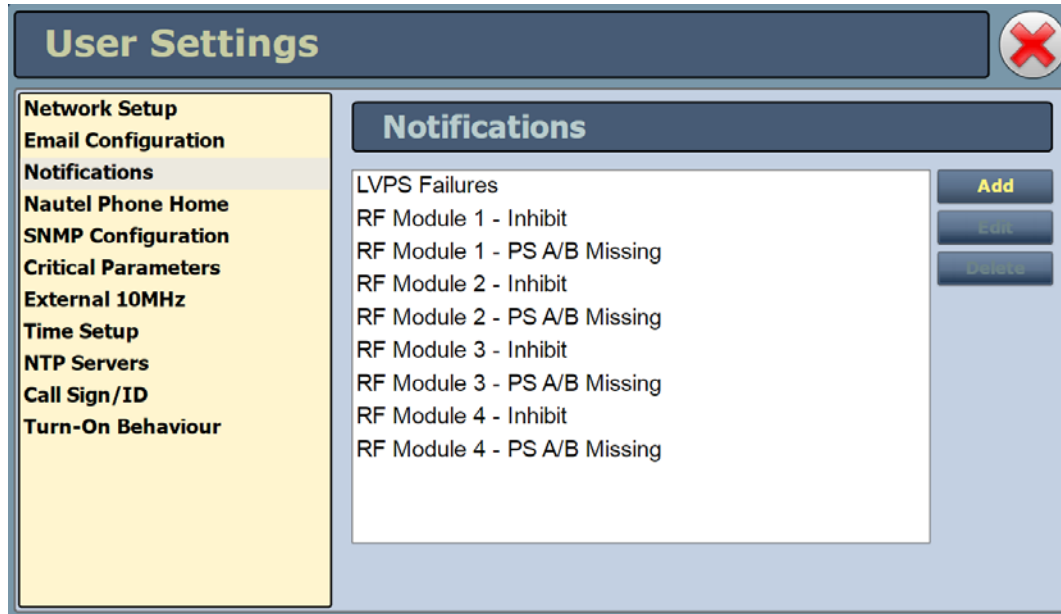

To configure the notifications feature, perform the following steps:

1. Pre-existing notifications are displayed in the Notifications list (e.g., "LVPS Failures". Click Add to create a new item for notification, click Edit (after highlighting an existing item) to edit an existing item or click Delete to erase an item.
2. When you click Add or Edit, the screen in [Figure 3.2.81](#) will appear. This screen allows you to add or edit a Notification Name, Recipient Email(s) (use a semi-colon to separate multiple email addresses, as applicable, and define the alarm list by Device type (Controller, Exciter A or B, Rack #or RF Module #). Add or remove alarms by moving them (using the >> and << arrow buttons) from the Available Alarms list to the Selected Alarms list. An email is issued when any alarm in the Selected Alarms list is active.

SMS Messaging: In the Recipient Email field, you can enter a standard email address to initiate an email or you can enter a mobile phone number and SMS gateway to initiate a text (SMS message). The email-to-text format is mobilenumbers@mobile_gateway (e.g., 5551234567@txt.bell.ca)

- ❖ Check with your mobile carrier to determine the proper gateway address for your area.
- ❖ Messages sent by the equipment should be less than 160 characters in length (standard SMS length).

3. When complete click the OK button to accept changes or the Cancel button to discard changes and return to the Notifications page.

Figure 3.2.81: Notifications adding/updating page

Notification

Notification Name

Recipient Email(s)

Device

Available Alarms

- 10kWReject Fan 1 Fail
- 10kWReject Fan 2 Fail
- 10kWReject Fan 3 Fail
- 5kWReject Fan 1 Fail
- 5kWReject Fan 2 Fail
- 5kWReject Fan 3 Fail
- 5kWReject Fan 4 Fail
- 5kWReject Fan 5 Fail
- 5kWReject Fan 6 Fail
- AC Summary
- ARM Network Down

< >

< >

Selected Alarms

- +1.2V Fail - Controller
- +1.8V Fail - Controller
- +12VA (AUJ) Fail - Controller
- +12V B (SBC) Fail - Controller
- +15V Fail - Controller
- +3.3V Fail - Controller
- +5V A Fail - Controller
- +5V B Fail - Controller
- 15V Fail - Controller

Nautel Phone Home

Phone Home is a system developed by Nautel that takes advantage of the vast amount of data collected by Nautel transmitters by proactively sending information to the cloud via the internet once a user enables Phone Home on their transmitter.

This data includes logs, alarms and meter readings which are then stored in a database and can be analyzed by Nautel staff if an alarm is reported by the transmitter. Since all data is pushed out to Nautel by the transmitter to the cloud, there is no need to reconfigure your firewall and potentially compromise your transmitters security. All data transfers are one way.

Nautel Transmitters are intelligent, collecting data on nearly every aspect affecting your transmitters performance. When this data is used by Nautel customer support staff for diagnostics purposes it cuts down on repair time and gets you back on air faster.

Nautel customer service technicians can use Phone Home to analyze data in real time, even accessing the live AUI, or to view the state of a customer’s transmitter at any time leading up to a fault.

This unique diagnostic approach allows Nautel support staff to review the events leading up to and during an alarm occurrence, giving customer service technicians valuable insight into how your transmitter is behaving before, during and after an alarm and how this behavior may be related to the alarm event.

Figure 3.2.82: Nautel Phone Home

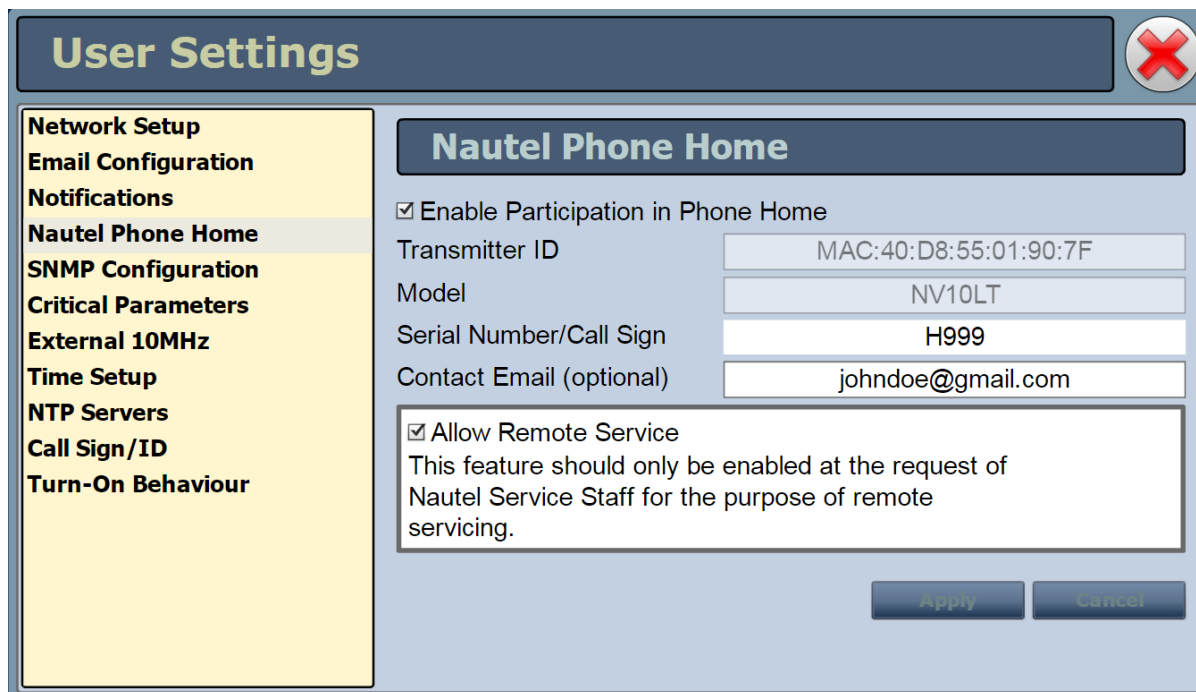

SNMP Configuration

The SNMP configuration page (see [Figure 3.2.83](#)) provides a means to configure the SNMP agent and associated traps.

Figure 3.2.83: SNMP Configuration page

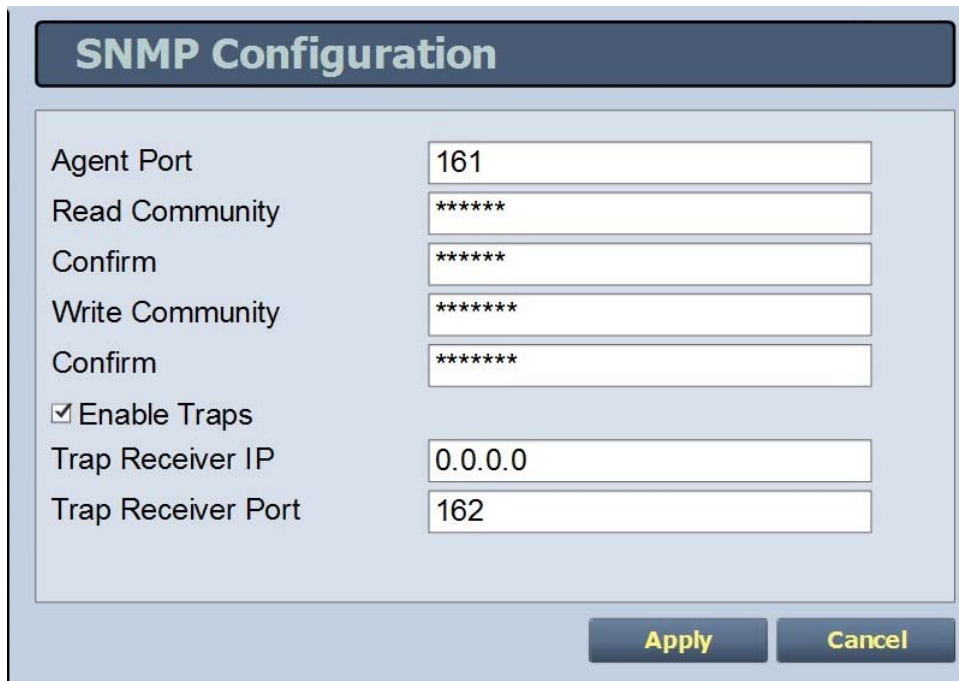

The image shows a web-based configuration window titled "SNMP Configuration". It contains several input fields and a checkbox. The fields are: "Agent Port" with the value "161"; "Read Community" with "*****"; "Confirm" with "*****"; "Write Community" with "*****"; "Confirm" with "*****"; "Trap Receiver IP" with "0.0.0.0"; and "Trap Receiver Port" with "162". There is a checked checkbox for "Enable Traps". At the bottom right, there are two buttons: "Apply" and "Cancel".

Agent Port	161
Read Community	*****
Confirm	*****
Write Community	*****
Confirm	*****
<input checked="" type="checkbox"/> Enable Traps	
Trap Receiver IP	0.0.0.0
Trap Receiver Port	162

Configure the SNMP agent as follows:

1. Enter the first five fields, noting the following:
 - ❖ Agent Port: Enter the UDP port where the SNMP agent checks for requests. The default setting is 161. If your transmitter is behind a firewall, you must open this port to use SNMP.
 - ❖ Read Community: Enter the password for the SNMP client application to allow acquisition of channel values. Provide confirmation of this password in the Confirm field.
 - ❖ Write Community: Enter the password for the SNMP client application to allow changing of channel values. Provide confirmation of this password in the Confirm field.
2. Select the Enable Traps check box () to allow the SNMP agent to send trap notifications, and to display two additional fields associated with traps. Enter the two additional fields as follows:

- ❖ Trap Receiver IP: Enter the IP address of the computer to which the SNMP agent will send trap notifications. The computer must be running an SNMP application that is configured to receive traps. The SNMP agent will send trap notifications to one receiver only.
- ❖ Trap Receiver Port: Enter the UDP port where the SNMP agent will send traps. The default setting is 162.

3. When complete press Apply or click Undo to restore the previous settings.

NOTE: Check the Read Community and Write Community passwords after a software upgrade. Some upgrades will clear passwords and require them to be reset.

Capturing Critical Parameters

You can capture critical parameter data for the transmitter’s current state using the AUI’s Critical Parameters page (see [Figure 3.2.84](#)). To view this page, select Critical Parameters from the User Settings page. From this page, you can click Capture Meters (reads all meter values), Capture Alarms (reads all active alarms), Capture Presets (reads current preset) and Capture Settings (reads current settings, e.g., active exciter, threshold settings, scale factors, etc.). Once you click the Capture button, you can click the associated Copy button to copy the data to your remote PC’s clipboard. The data copies in a tab-delimited format and is ideally suited for pasting into a spreadsheet program. Click X in the upper, right corner to close this page and return to the home page.

Figure 3.2.84: Critical Parameters page

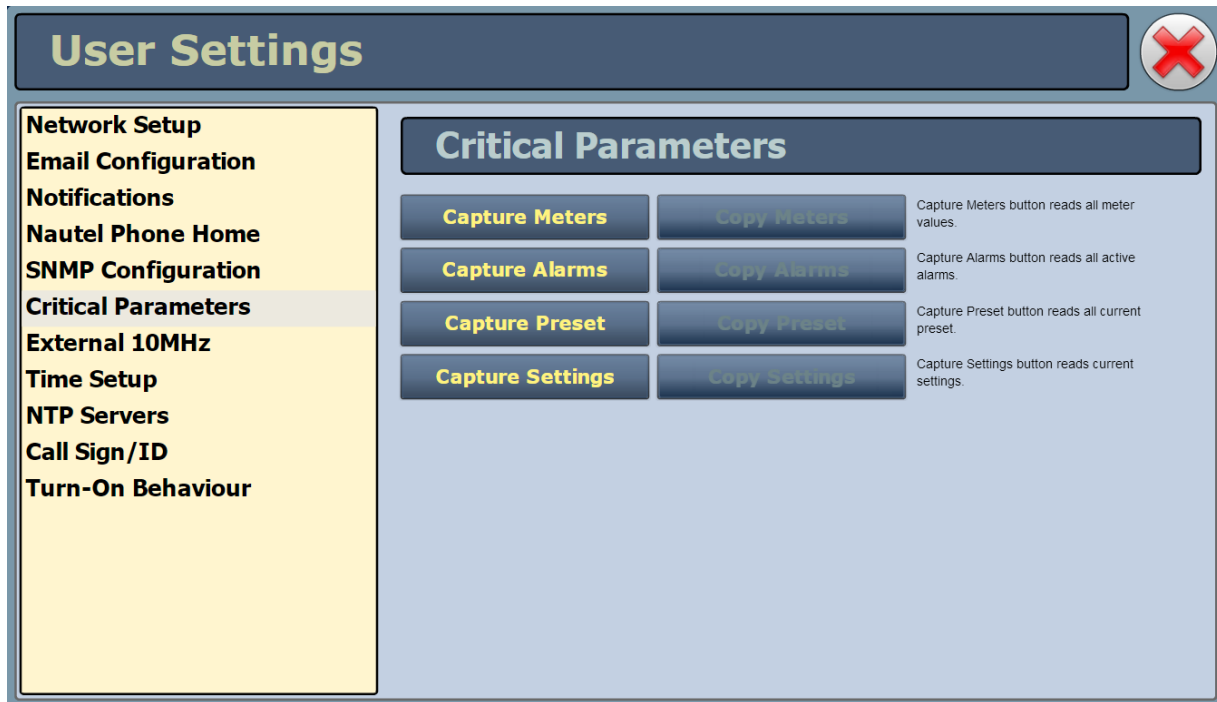

Using an External 10 MHz Input

You can configure the NV20LT/NV15LT to accept an external 10 MHz input using the remote AUI (see [External 10 MHz Input - Using the AUI](#)) or using the local front panel display (see [External 10 MHz Input - Using the Front Panel, on page 3.2.111](#)). This setting allows the user to mask the associated 10 MHz alarm from appearing on the Status page if it isn't being used. If an external 10 MHz source is being used, select Yes; this ensures that an alarm will be activated on the Status page should the external signal be lost. If an external 10 MHz source is not being used, leave the default No setting as is. This will ensure that no alarm will be displayed on the Status page despite the presence of the external 10 MHz signal.

NOTE: The exciter will automatically use an external 10MHz reference signal if connected, no matter the state of this parameter.

External 10 MHz Input - Using the AUI

You can view the selection buttons for the external 10 MHz input on the AUI's External 10 MHz screen (see [Figure 3.2.85](#)) by selecting External 10 MHz from the User Settings options. Yes and No buttons for Use External 10MHz will be displayed. Click Yes if you are using an external 10 MHz signal. Click No if not. Click X in the upper, right corner to close this page and return to the home page.

Figure 3.2.85: External 10 MHz screen

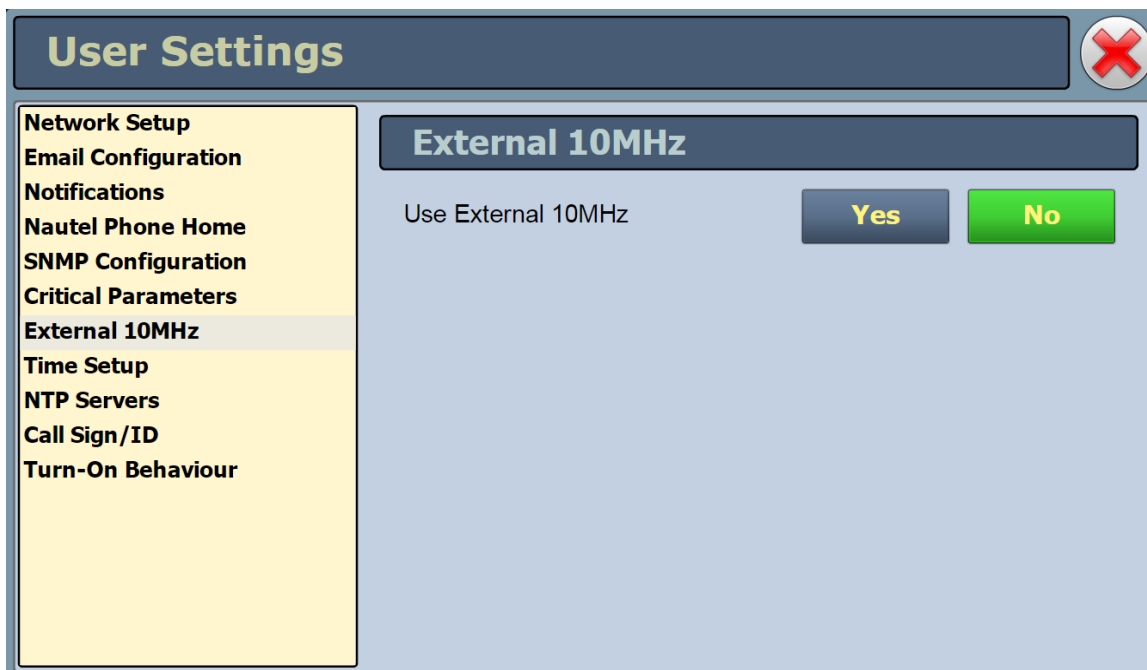

External 10 MHz Input - Using the Front Panel

To view the enable/disable screen for the external 10 MHz input (see [Figure 3.2.86](#)), select User Settings -> Ext. 10 MHz Inp from the Main Menu.

Figure 3.2.86: Front Panel - External 10 MHz Input screen

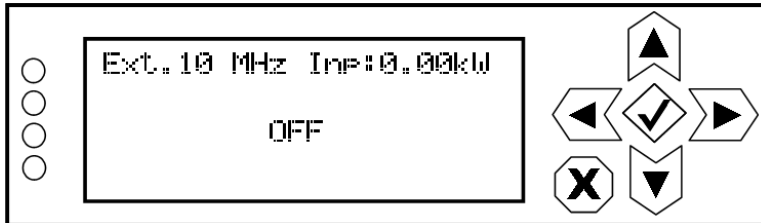

Use the up or down arrow to toggle between ON (using external 10 MHz input) and OFF (not using external 10 MHz input), then press the accept (checkmark) button to save the change. Press cancel (X) to discard changes and return to the previous menu.

Setting the Clock

The NV20LT/NV15LT controller module’s internal clock uses an externally accessible backup battery, and therefore maintains an accurate date and time, even during power outages. The date and time needs to be set when the transmitter is first installed, or after a power outage if the backup battery has failed.

You can set the date and time using the remote AUI (see [Setting the Clock - Using the AUI](#)) or using the local front panel display (see [Setting the Clock - Using the Front Panel](#), on page 3.2.114). If you change the clock setting on the front panel UI, it will also be reflected on the remote AUI, and vice versa. If the NTP feature is enabled (see [Enabling NTP](#), on page 3.2.115), the clock will set automatically and cannot be manually adjusted.

Setting the Clock - Using the AUI

You can remotely set the NV20LT/NV15LT’s time and date using the AUI’s Time Setup page (see [Figure 3.2.87](#)) by selecting Time Setup from the User Settings options. The date and time setting is displayed in the upper, left corner of the AUI.

Figure 3.2.87: Time Setup Page

The screenshot shows a web-based configuration interface titled "User Settings" with a red close button in the top right. On the left is a sidebar menu with the following items: Network Setup, Email Configuration, Notifications, Nautel Phone Home, SNMP Configuration, Critical Parameters, External 10MHz, Time Setup (highlighted), NTP Servers, Call Sign/ID, and Turn-On Behaviour. The main content area is titled "Time Setup" and contains the following fields and controls:

- Time:** Three dropdown menus for Hour (23), Min (21), and Sec (1).
- Date:** Three dropdown menus for Day (13), Month (Sep), and Year (empty).
- Timezone:** A text input field containing "America/Halifax UTC -4:00".
- Region:** A dropdown menu with "Select a region..." as the selected option.
- Country:** An empty dropdown menu.
- Zone:** An empty dropdown menu.

There are "Apply" and "Cancel" buttons at the bottom right of the Time Setup section.

The Time Setup option allows users to set the exact time and date information as well as regional and timezone settings for a transmitter location. Set the time and date as follows:

1. Select the Time Setup option from the left-side of the User Settings page to open a related window on the right-side of the page.
2. Enter Time and Date parameters and press Apply. Press Cancel to discard changes.
 - ❖ Time - enter the hour (24-hour clock), minutes (up to 60), and seconds (up to 60).
 - ❖ Date - select values from the drop-down menus beside Day, Month, and Year.
3. Enter the following location parameters and press Apply. Press Cancel to discard changes:
 - ❖ Timezone - automatically set based on Region, Country and Zone selections.
 - ❖ Region - select the appropriate region from the drop-down menu.
 - ❖ Country - select the appropriate country from the drop-down menu.
 - ❖ Zone - select the appropriate zone from the drop-down menu.

NOTE: Changes cannot be made via this menu if NTP is enabled. Disable NTP, make required changes in the Time Setup menu then re-enable NTP (see [Enabling NTP, on page 3.2.115](#)).

The Time Setup page contains editable fields for the time (hours, minutes and seconds), date (day, month and year) and time zone (region, country and zone). The clock is displayed in 24-hour format. Use the drop-down menus to select the desired value for a specific field. Click the appropriate Apply button to accept changes or Cancel to discard them.

NOTE: Ensure the proper Zone is selected to observe Daylight Savings time (DST).

Setting the Clock - Using the Front Panel

When you select User Settings -> Set Clock from the Main Menu (see [Figure 3.2.88](#)) you can set the current time and date. The time appears on the top line of the top level screen (see [Figure 3.2.4 on page 3.2.9](#)).

Figure 3.2.88: Set Clock screen

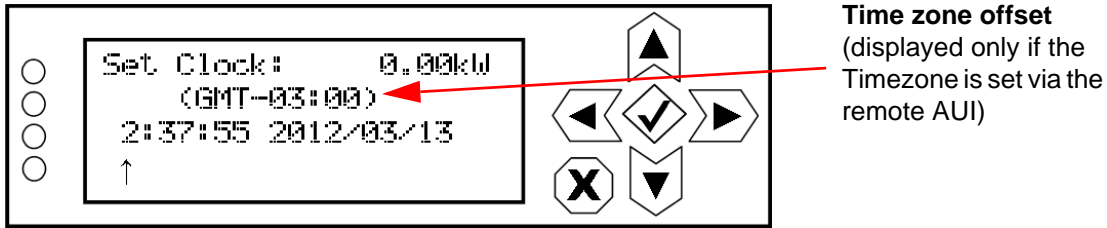

To change the time or date, use the right and left arrow buttons to move the cursor to the desired field (hours, minutes, seconds, year, month, day), and use the up and down arrow buttons to increase or decrease the value of the selected field as desired. When complete, press the accept (checkmark) button to save the change. Press the cancel (X) button to discard changes and return to the previous menu.

The time zone offset line (e.g., GMT-03:00) appears only if the Timezone has been established in the remote AUI's Time Setup page.

Configuring NTP Servers

NOTE: The following function is only available via remote connection to the AUI; however, the use of NTP can also be enabled/disabled from the front panel UI (see [Enabling NTP, on page 3.2.115](#)).

You can configure one or more NTP (Network Time Protocol) servers to allow clock synchronization with all computers on the same network as the NV20LT/NV15LT. To view the AUI's NTP Servers page (see [Figure 3.2.89](#)), selecting NTP Servers from the User Settings options. There are several functions available on this page - enabling NTP, monitoring NTP server status and managing servers.

NOTE: The accuracy of the NTP synchronization is related to the distance to the server. For this reason, Nautel recommends that you choose servers in the same country as the equipment. If this is not possible, attempt to connect to servers from the same continent.

NOTE: *The NTP clock synchronization polling interval varies between 64 and 1024 seconds. To minimize network traffic, the interval will change depending on how much error is accumulated between polling events and will be increased if the remote NTP server becomes unreachable. The polling interval is also randomized slightly to avoid the situation where a large number of requests are always arriving at the NTP server at the same time.*

Figure 3.2.89: NTP Servers Page

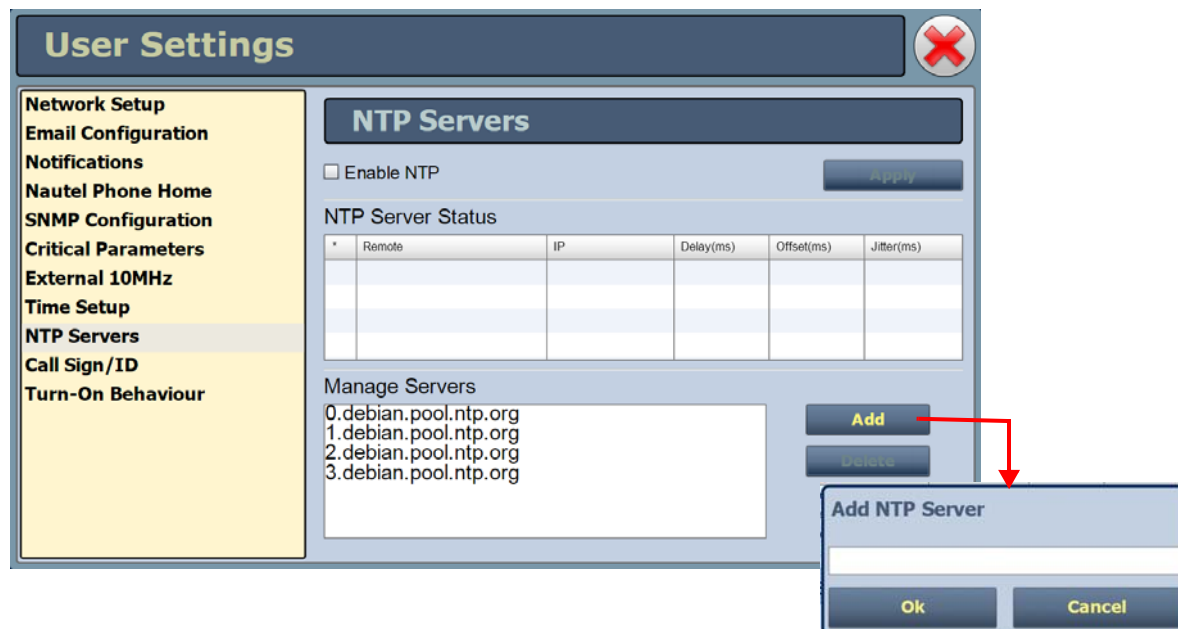

Enabling NTP

Enable the NTP function by selecting the Enable NTP checkbox. Disable by de-selecting the Enable NTP checkbox. Click the Apply button to activate any change.

Monitoring NTP Servers

The NTP Server Status section displays tabular information on the NTP servers connected to the network. The table includes remote name, IP address, delay, offset and jitter.

- ❖ Remote Name: Displays the host name of the referenced time source. An asterisk (*) in the first column marks the reference time source that is currently preferred by the NTP daemon. A '+' character in the first column marks high quality candidates for the reference time that could be used if the currently selected reference becomes unavailable.
- ❖ IP: Displays the IP address associated with the Remote Name. In some cases the Remote Name could be the IP address.
- ❖ Delay: Displays the round-trip delay (in ms) of the time queries.
- ❖ Offset: Displays the difference (in ms) between the reference time and the system clock.
- ❖ Jitter: Displays the magnitude of jitter (in ms) between several time queries.

Managing NTP Servers

The Manage Servers section displays the NTP server files that have been added. You can Add to the list of NTP servers (see [Figure 3.2.90](#)) or Delete a selected NTP server from the list.

Figure 3.2.90: Add NTP Server

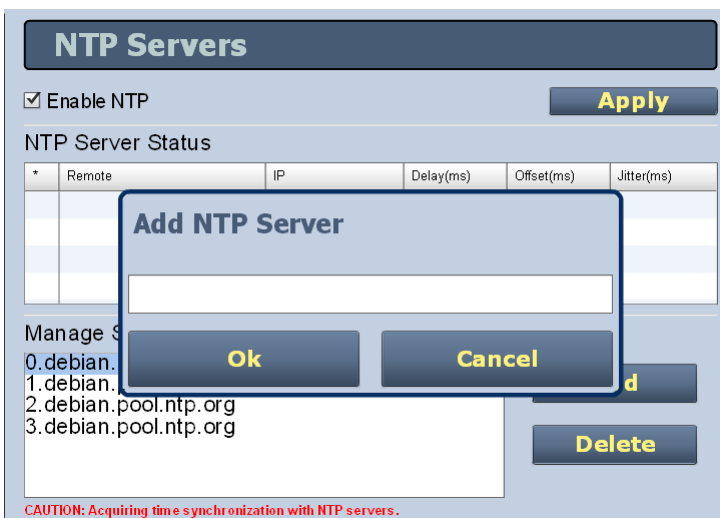

Setting User Thresholds

You can set thresholds for the main audio and SCA sources (trip level and timeout) and forward power level using the AUI (low and very low power thresholds) (see [Setting User Thresholds - using the AUI](#)) or using the front panel UI (see [Setting Low Audio Thresholds, on page 3.2.126](#) and [Setting Low Forward Power Thresholds, on page 3.2.128](#)). These thresholds determine the limit for an associated low audio or low forward power alarm to be activated.

If you change a user threshold on the front panel UI, it will also be reflected on the AUI, and vice versa.

Setting User Thresholds - using the AUI

The AUI's User Thresholds page (see [Figure 3.2.91](#)) has two tab sections - Low Audio and Low Forward Power.

Figure 3.2.91: User Settings - User Thresholds Page and tab sections

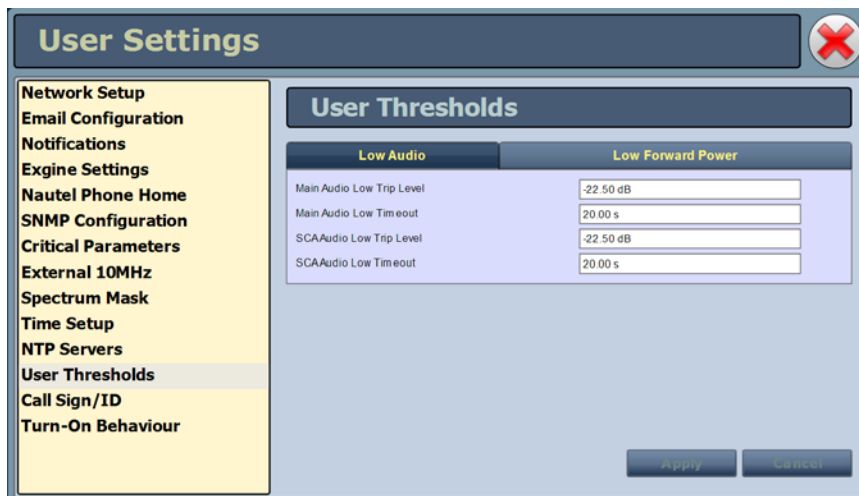

Default values shown

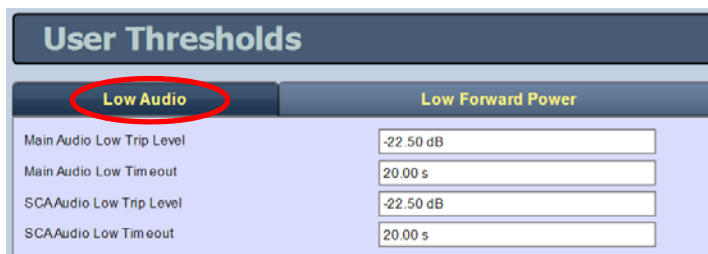

Valid range -100 to -3 dB
Valid range 0 to 600 s
Valid range -100 to -3 dB
Valid range 0 to 600 s

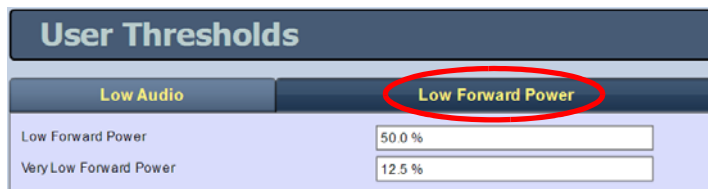

Valid range 0 to 100%
Valid range 0 to 100%

- Selecting the Low Audio tab displays a screen that allows for setting of the low trip level and timeout delay for the main audio and SCA audio low thresholds.
 - ❖ If the applicable audio source (main or SCA) level falls below the Trip Level setting (default is -22.5 dB) for longer than the Timeout setting (default is 20 s), an alarm will activate in the Status and Logs pages. When the audio source level increases above the Trip Level, the alarm will clear. To disable the low audio alarm, set the associated Trip Level to -100 dB. Press Apply to save the change or Cancel to discard changes.
- Selecting the Low Forward Power tab displays a screen that allows for setting of the threshold for the low forward power and very low forward power alarms.
 - ❖ If the forward power falls below the low threshold setting (default is 50% of the setpoint) or below the very low threshold setting (default is 12.5% of the setpoint), the associated alarm will activate in the Status and Logs pages. When the forward power level increases above a threshold, the alarm will clear. To disable the low forward power alarms, set the associated percentage to 0%. Press Apply to save the change or Cancel to discard changes.

Setting Call Sign/ID

You can set a name that identifies the transmitter on the AUI. To view the AUI's Call Sign/ID page (see [Figure 3.2.92](#)), select Call Sign/ID from the User Settings options. This identification will be displayed in brackets on the top transmitter banner of the AUI and also be included as a header in any Critical Parameter data copied and pasted to a spreadsheet program (see [Capturing Critical Parameters, on page 3.2.109](#)).

Enter the call sign or ID in the field (e.g., NVLT - 101) and press Apply (maximum 15 characters in length).

Figure 3.2.92: Setting Call Sign/ID

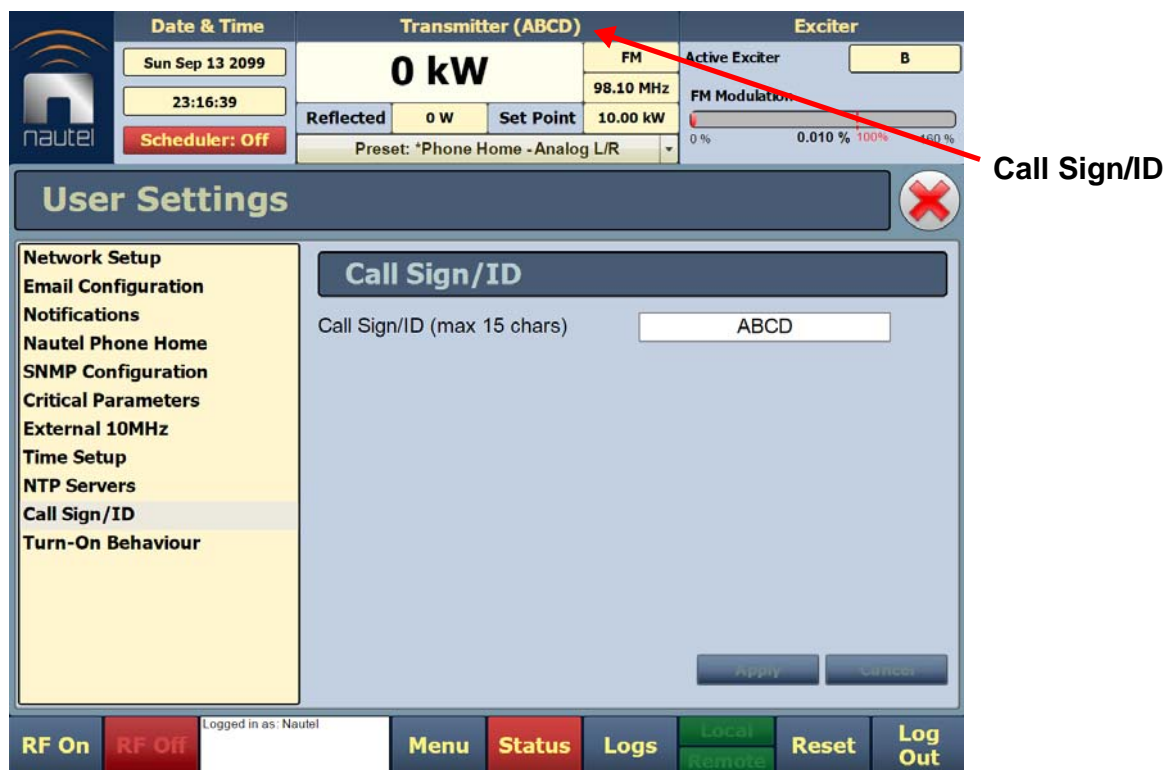

Turn-On Behaviour

The Turn-On Behaviour page (see [Figure 3.2.93](#)) allows users to delay the start-up (RF on) of the transmitter when recovering from an ac power loss, in order to limit the simultaneous power demand from multiple transmitters on a common generator by staggering their turn on sequence.

- ❖ Enter a value for Turn-On Delay in the allowable range of 0-120 seconds, defaulted to 0 seconds (disabled).
- ❖ Enter a value for Ramp-Up Speed in the allowable range of 0-100%, defaulted to 100% (normal).

Press Apply to save the change or Cancel to discard changes.

Figure 3.2.93: Turn-On Behaviour

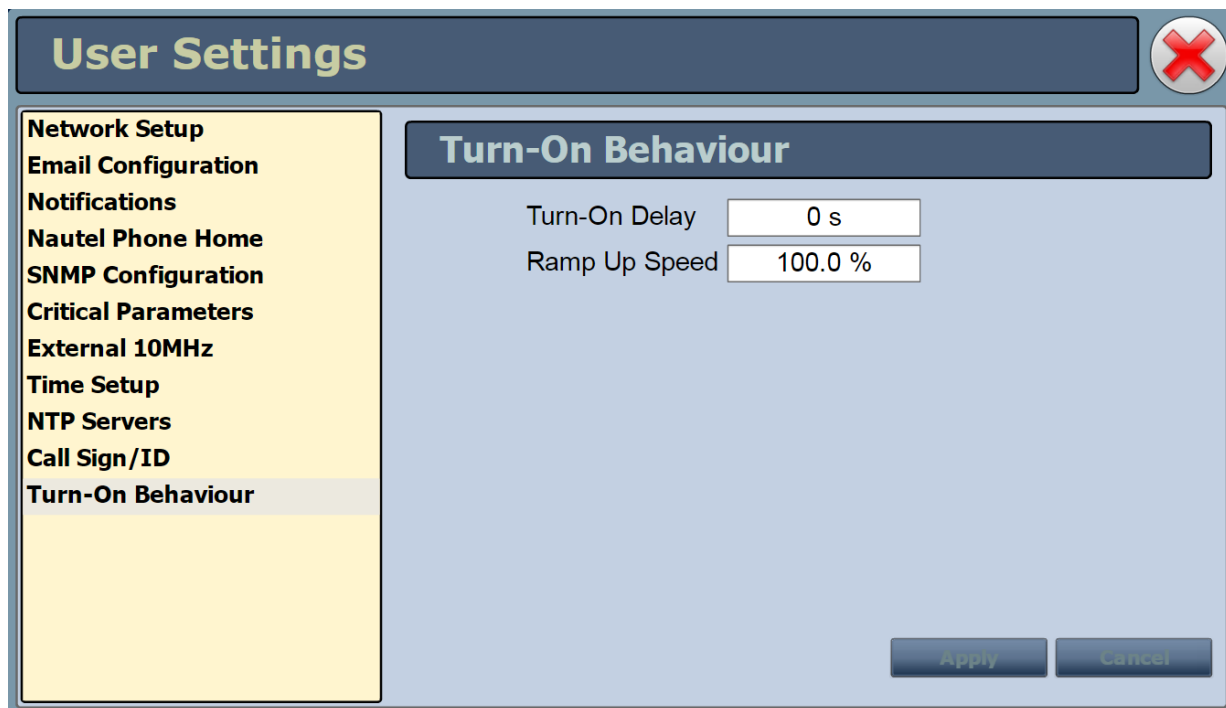

NOTE: Turn-on behaviour parameters can also be adjusted using the front panel display (see [Turn-On Delay Setting, on page 3.2.129](#) and [Ramp-Up Speed Setting, on page 3.2.129](#)).

User Settings - Front Panel UI

You can establish various user settings for the NV20LT/NV15LT using the local front panel display. The following options are available:

- Edit Presets: see [Managing Presets - Using the Front Panel](#), on page 3.2.73
- Set Clock: see [Setting the Clock - Using the Front Panel](#), on page 3.2.114
- Network Settings: see [Network Setup - Using the Front Panel](#), on page 3.2.99
- Setting Pilot Sample Level - see page 3.2.122
- Configure Test Signal Generator - see page 3.2.123
- Ext. 10 MHz Input: see [External 10 MHz Input - Using the Front Panel](#), on page 3.2.111
- Scheduler: see [Enabling the Scheduler - Front Panel](#), on page 3.2.172
- Selecting FM Mask - see page 3.2.125
- Audio Low: see [Setting Low Audio Thresholds](#), on page 3.2.126
- Fwd Low: see [Setting Low Forward Power Thresholds](#), on page 3.2.128
- Turn-On Delay Setting - see page 3.2.129
- Ramp-Up Speed Setting - see page 3.2.129

Setting Pilot Sample Level

NOTE: Setting the pilot sample is only available using the front panel display.

From the front panel UI, you can set the level of the pilot sample that is applied to the PILOT SAMPLE OUT (A1J4A) BNC connector on the rear of the controller (A4). To view the Pilot Sample screen, select User Settings -> Pilot Sample from the Main Menu (see [Figure 3.2.94](#)).

Figure 3.2.94: Pilot Sample Screen

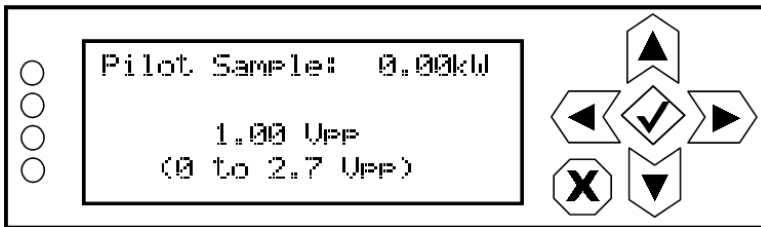

Use the up and down buttons to edit the pilot sample level between 0 and 2.70 V peak-to-peak (in 0.01 V increments). Press the accept (checkmark) button to save the change. Press cancel (X) to discard changes and return to the previous menu.

Configure Test Signal Generator

NOTE: The test signal generator function is only available using the front panel display.

From the front panel UI, you can configure the test signal generator output of the NV20LT/NV15LT. Note that a different menu will appear depending on the currently configured test signal type. To view the Signal Gen screen, select User Settings -> Signal Gen from the Main Menu (see [Figure 3.2.95](#)).

Figure 3.2.95: Signal Generator Menus

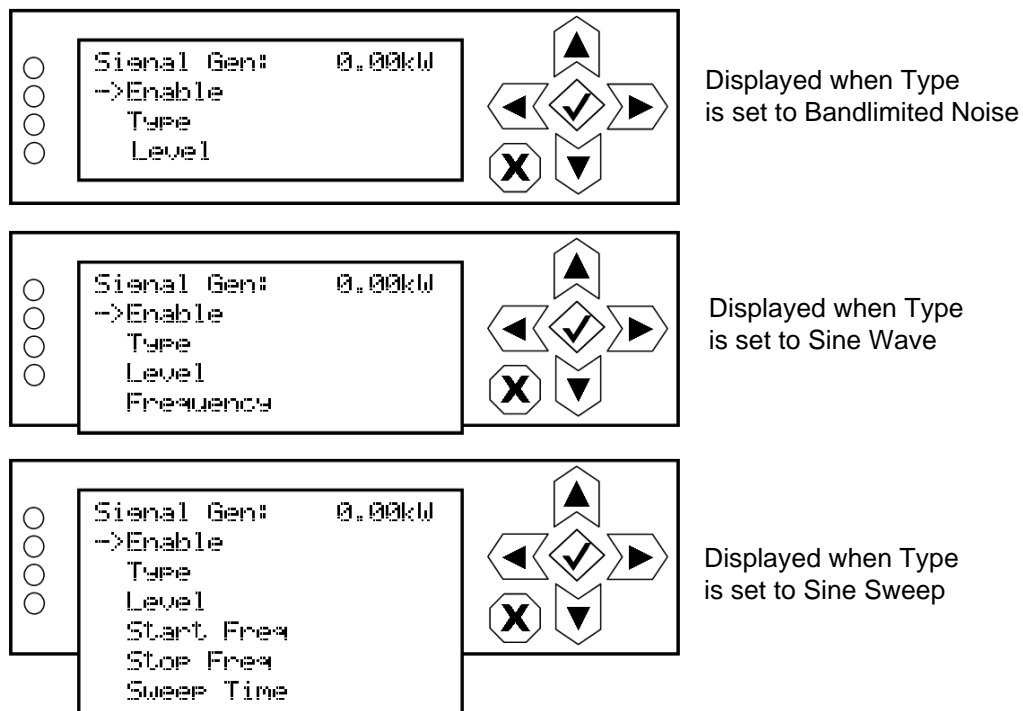

Use the up and down buttons to move the cursor to the desired line item and then press the right button to enable editing.

[Figure 3.2.96 on page 3.2.124](#) shows all possible editing screens for the Signal Gen menu. Within any of the editing screens, use the up and down buttons to edit the setting. Press the accept (checkmark) button to save the change. Press cancel (X) to discard changes and return to the previous menu.

Figure 3.2.96: Signal Generator Editing Screens

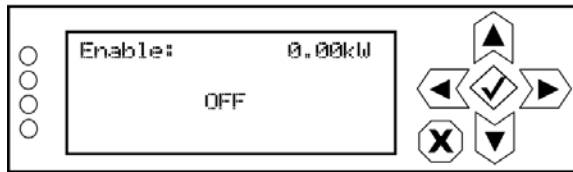

Select ON (enabled) or OFF (disabled). Press the cancel (X) button to discard changes and return to the previous menu. Default is OFF.

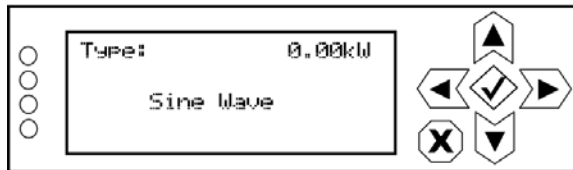

Select a type - None, Sine Wave, Sine Sweep or Bandlimited Noise. Press the cancel (X) button to discard changes and return to the previous menu.

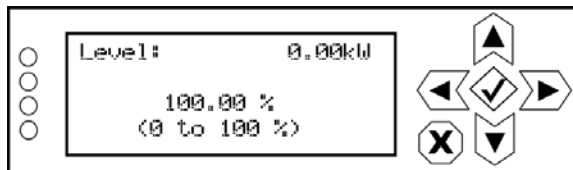

Select a level between 0 and 100%. Press the cancel (X) button to discard changes and return to the previous menu. Default is 100%.

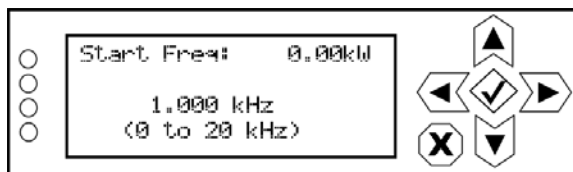

When Type is set to Sine Sweep or Sine Wave, select a start frequency between 0 and 20 kHz. Press the cancel (X) button to discard changes and return to the previous menu. Default is 1 kHz.

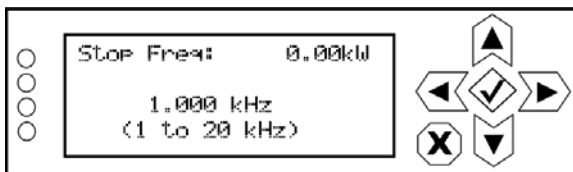

When Type is set to Sine Sweep, select a stop frequency between 1 and 20 kHz. Press the cancel (X) button to discard changes and return to the previous menu. Default is 1 kHz.

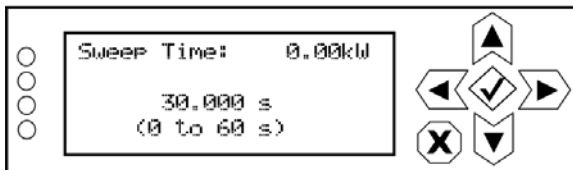

When Type is set to Sine Sweep, select a time between 0 and 60 s. Press the cancel (X) button to discard changes and return to the previous menu. Default is 30 s.

Selecting FM Mask

NOTE: FM Mask selection is only available using the front panel display.

From the front panel UI, you can select the appropriate FM mask standard (FCC, ETSI or None) being used by the analyzer on the AUI. The selection affects the mask lines on the AUI's Spectrum Analyzer instrument. To view the FM Mask screen, select User Settings -> FM Mask from the Main Menu (see [Figure 3.2.97](#)).

Figure 3.2.97: FM Mask Screen

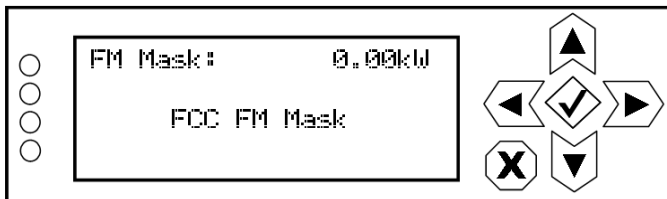

Use the up and down buttons to toggle between FCC FM Mask, ETSI FM Mask and No FM Mask. The factory setting is FCC FM Mask. Press the accept (checkmark) button to save the change. Press cancel (X) to discard changes and return to the previous menu.

Setting Low Audio Thresholds

NOTE: Low audio threshold and timeout settings are available using the front panel UI display or the Remote AUI (see [Setting User Thresholds - see page 3.2.117](#)).

From the front panel UI, you can establish the low audio thresholds and timeout delays for the main audio and SCAs. To view the Audio Low screen, select User Settings -> Audio Low from the Main Menu (see [Figure 3.2.98](#)).

Figure 3.2.98: Audio Low Menu

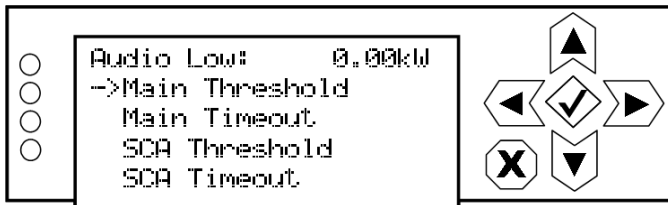

Use the up and down buttons to move the cursor to the desired line item and then press the right button to enable editing. [Figure 3.2.99](#) shows all possible editing screens for the Audio Low menu. Within any of the editing screens, use the up and down buttons to edit the setting. Press the accept (checkmark) button to save the change. Press cancel (X) to discard changes and return to the previous menu.

Figure 3.2.99: Audio Low Editing Screens

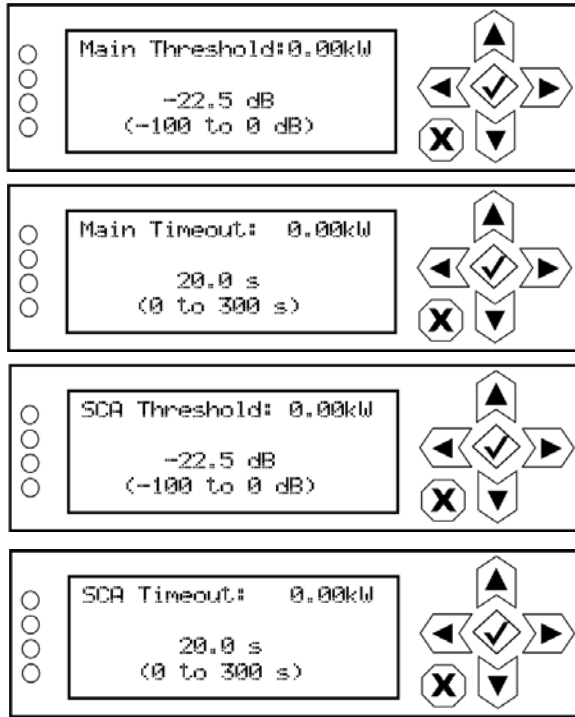

Select a level between -100 and 0 dB (in 0.5 dB increments). Press the cancel (X) button to discard changes and return to the previous menu. Default setting is -22.5 dB.

Select a timeout between 0 and 300 s (5 minutes) (in 0.5 s increments). Press the cancel (X) button to discard changes and return to the previous menu. Default setting is 20 s.

Select a level between -100 and 0 dB (in 0.5 dB increments). Press the cancel (X) button to discard changes and return to the previous menu. Default setting is -22.5 dB.

Select a timeout between 0 and 300 s (5 minutes) (in 0.5 s increments). Press the cancel (X) button to discard changes and return to the previous menu. Default setting is 20 s.

Setting Low Forward Power Thresholds

Low audio threshold and timeout settings are available using the front panel UI display or the Remote AUI (see [Setting User Thresholds - see page 3.2.117](#))

From the front panel UI, you can establish the low forward power thresholds for the NV20LT/NV15LT. There are two thresholds available - low power and very low power. To view the Fwd Low menu, select User Settings -> Fwd Low from the Main Menu (see [Figure 3.2.100](#)).

Figure 3.2.100: Fwd Low Menu

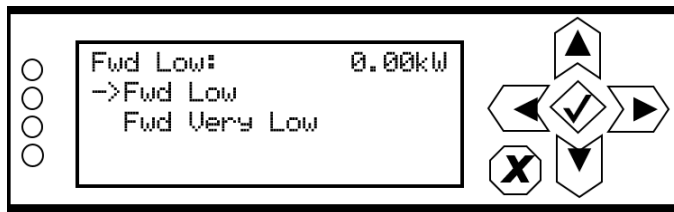

Use the up and down buttons to move the cursor to the desired line item and then press the right button to enable editing. [Figure 3.2.101](#) shows the two editing screens for the Fwd Low menu. Within either of the editing screens, use the up and down buttons to edit the setting. Press the accept (checkmark) button to save the change. Press cancel (X) to discard changes and return to the previous menu.

Figure 3.2.101: Fwd Low Editing Screens



Select a threshold between 0 and 100% (in 0.5% increments), that corresponds to a percentage of rated power. Press the cancel (X) button to discard changes and return to the previous menu. Default setting is 50% (equivalent to 3 dB power reduction).

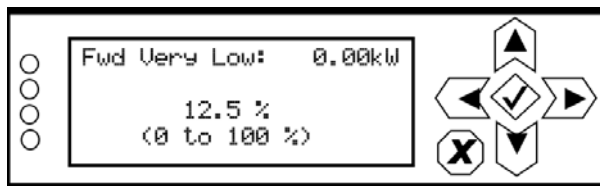

Select a threshold between 0 and 100% (in 0.5% increments), that corresponds to a percentage of rated power. Press the cancel (X) button to discard changes and return to the previous menu. Default setting is 12.5% (equivalent to 9 dB power reduction).

Turn-On Delay Setting

NOTE: The turn-on delay setting can also be adjusted using the remote AUI (see [Turn-On Behaviour](#), on page 3.2.120).

From the front panel UI, you can set the transmitter's turn-on delay. This setting determines the time delay for the transmitter to recover from an ac power loss. This is typically used in sites with multiple transmitters on a common generator. By staggering the turn-on delay periods of each transmitter, you can reduce the overall load on the generator. To view the Turn On Delay screen, select User Settings -> Turn On Delay from the Main Menu (see [Figure 3.2.102](#)).

Figure 3.2.102: Turn On Delay Screen

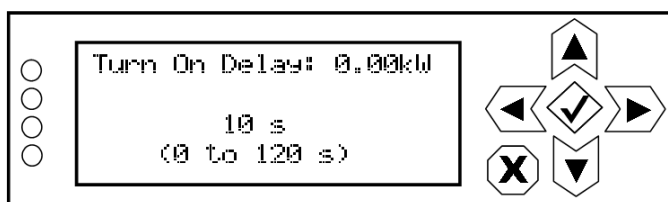

Use the up and down buttons to select a delay between 0 and 120 s (in 1 s increments). The default setting is 0 s (disabled). Press the accept (checkmark) button to save the change. Press X to abort the change and return to the previous menu.

Ramp-Up Speed Setting

NOTE: The ramp-up speed setting can also be adjusted using the remote AUI (see [Turn-On Behaviour](#), on page 3.2.120).

From the front panel UI, you can set the transmitter's ramp-up speed. This setting establishes the time it takes the transmitter to ramp up from 0 W to full power. At 100%, ramp-up speed is approximately seven seconds. For a setting of 50%, ramp-up would be approximately 14 seconds. For a setting of 25%, ramp-up would be approximately 28 seconds. In multi-transmitter systems that are on a common generator or power grid, adjusting the ramp-up speed can be used to reduce the transient load on the source during an ac power recovery (i.e., after a power failure or changeover to a generator).

To view the Ramp-up Speed screen, select User Settings -> Ramp-up Speed from the Main Menu (see [Figure 3.2.103](#) on page 3.2.130).

Figure 3.2.103: Ramp-up Speed Screen

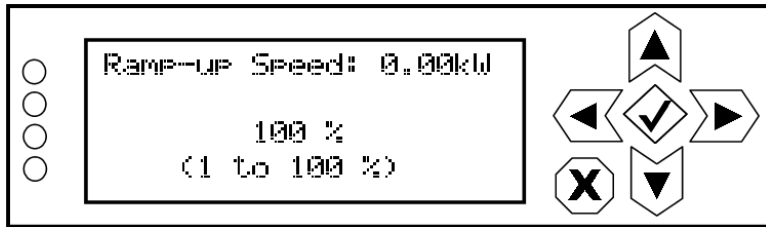

Use the up and down buttons to select a ramp-up speed between 1 and 100% (in 1% increments), noting 100% represents approximately seven seconds (0 W to full power). The default setting is 100%. Press the accept (checkmark) button to save the change. Press X to abort the change and return to the previous menu.

User Accounts

NOTE: This function is only available via the remote AUI.

Depending on user permission rights, you can set up accounts to allow certain users to access and control features of the AUI using the [User Accounts page](#) - see [Figure 3.2.104](#). To view the User Accounts page, select User Accounts from the Menu options.

NOTE: Depending on the permission level assigned to a given user, some features shown in [Figure 3.2.104](#) may not be displayed or available.

This section includes the following topics:

- [Setting User Permission Level](#), on page 3.2.132
- [Editing Account Information](#), on page 3.2.132
- [First-Time Login](#), on page 3.2.134

Figure 3.2.104: User Accounts page

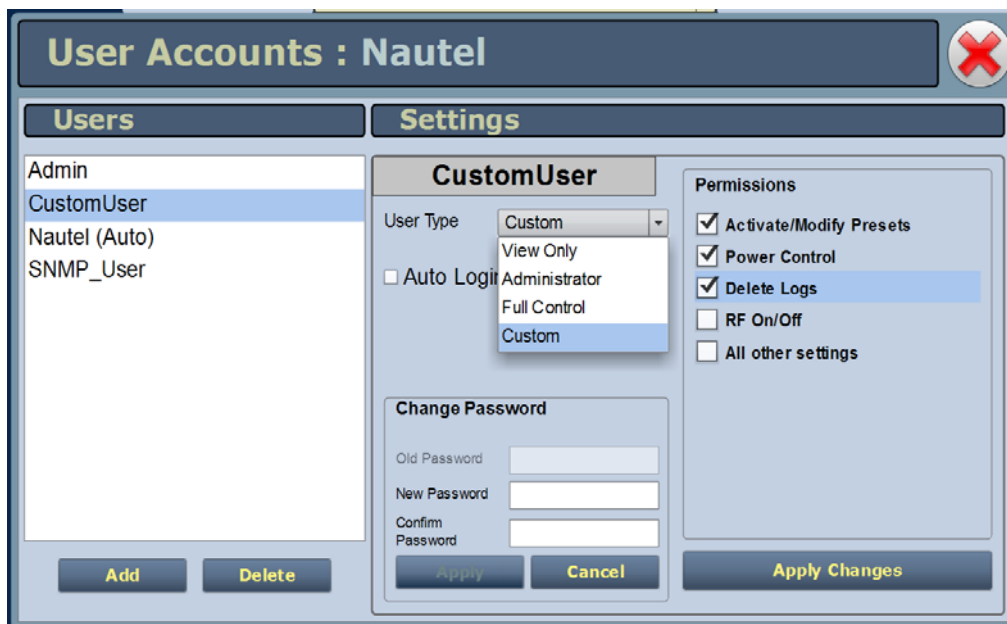

The NV20LT/NV15LT contains a default user account when it leaves the factory. This account appears as Nautel (Auto) in the List of Users and has Administrator permission level. The default Username is "Nautel". The default Password is blank (i.e., no password). Nautel recommends that you delete this account once you create the desired user account(s) (see [First-Time Login](#), on page 3.2.134).

Setting User Permission Level

There are four levels of permission that can be assigned to users, each with their own specific function. All users have permission to change their own username and password, but are otherwise limited to the following functions:

- View Only: Can monitor equipment data only. No administrative or control functions.
- Full Control: Can monitor and control equipment, with no administrative functions.
- Administrator: Can perform all functions. Administrator is the only permission level that allows addition, removal or modification of users.
- Custom: Administrator can customize the user permissions by manually selecting the permission levels.

Editing Account Information

Adding an Account

You must be an Administrator to use this function.

Procedure to add a user (see [Figure 3.2.105 on page 3.2.134](#)):

1. Open the User Accounts page.
2. Click Add (bottom of the screen) to open a small Add User window.
3. Beside Username, enter a name that identifies the new user, and click OK.
4. Select the new user to edit the settings.
5. Beside User Type, press the arrow to reveal a drop-down menu and select a type of user. If you select Custom as the type of user, then go to the Permissions section of the screen and mark individual permissions (see [Changing Permissions, on page 3.2.133](#)).
6. Click Apply to confirm your entries and create a new user or click Cancel to ignore your entries and exit the small window without creating a new user.

Editing an Existing Account

To edit an existing user account, click on the desired user in the Users list on the left-side of the AUI. The Settings for that user will be displayed on the right-hand side of the AUI. You can edit the Password, User Type (see [Setting User Permission Level](#) above), Auto Login status and Permissions.

Changing the Password

To change your password, click the Change Password button. A menu appears that prompts you to enter the old password, new password and confirmation of the new password. Click Apply to save or Cancel to exit this menu (see [Figure 3.2.105 on page 3.2.134](#)).

Setting Auto Login (Local Only) Status

When checked () the selected user account will be automatically logged in to the transmitter with all the rights and privileges that have been assigned to that user. There may only be one autologin user at any given time; when the Auto Login check box is selected for one user account, it is automatically cleared on all other users. When not checked, the transmitter will not login automatically and will instead prompt for username and password when it boots up. It should be noted that only accounts with Administrator level permissions can set or remove Auto Login status.

Changing Permissions

You must be an Administrator to edit this function.

All users have permission to change their own username and password. You can customize the permissions assigned to a user or simply pick a predetermined set of permissions based on the user type.

Procedure to change user permissions (see [Figure 3.2.105 on page 3.2.134](#)):

1. Open the User Accounts page.
2. Select a user from the Users list to display the permissions for that user in the center of the Permissions window. The permissions associated with the selected user are identified with a checkmark ()
3. Click User Type to reveal a drop-down menu and select a new type of user.
4. If the user type in step 3 is Custom, set individual permissions. Under Permissions, place a checkmark () beside each permission that you want to associate with the user. The boxes work like a toggle - select the checkbox to place a checkmark and select again to remove the checkmark. Choose one or more of the following options:
 - ❖ Activate/Modify Preset - Allows the user to modify presets and change the active preset.
 - ❖ Power Control - Allows the user to change the power set point of the transmitter.
 - ❖ Delete Logs - Allows the user to remove log entries.

- ❖ RF On/Off - Allows the user to turn the RF output on and off.
- ❖ All Other Settings - Allows the user to adjust all settings not mentioned above, except for administrating user accounts.

5. Click Apply to assign the new permissions to the selected user.

Removing an Account

To remove a user account, select the desired user from the Users list and click the Delete button. A verification prompt will appear. Press Yes to proceed or No to cancel the deletion.

NOTE: Do not delete the SNMP_User account from the list of users.

Figure 3.2.105: User Accounts Page Layout

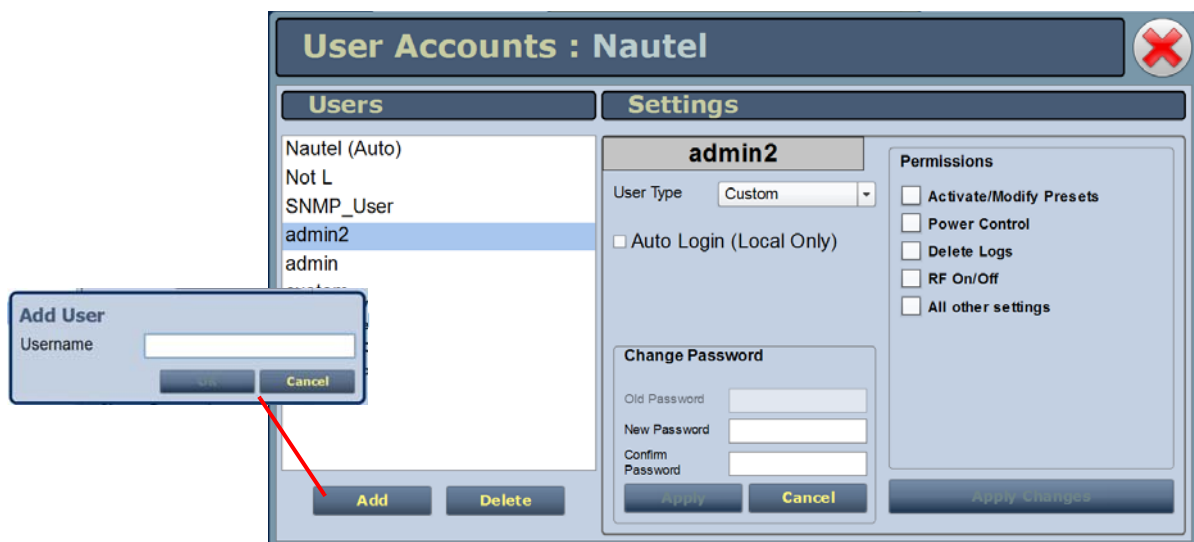

First-Time Login

When you enter the User Accounts page for the first time, it is recommended you create an account and then delete the default Nautel account, as follows:

1. Login to the AUI using the default Username (“Nautel”) and Password (blank).
2. Set up your own Administrator account, with your desired Username and Password.
3. Logout of the AUI, then login to your new Administrator account.
4. Delete the “Nautel” account.

System Settings

Users can determine critical system configuration parameters using the AUI (see [System Settings - using the AUI](#)) or using the front panel UI (see [System Settings - using the Front Panel UI, on page 3.2.140](#))

System Settings - using the AUI

The AUI's System Settings page (see [Figure 3.2.106](#)) is accessible from the Main Menu options. It contains the following options:

- [Reboot, on page 3.2.136](#)
- [Upgrade Software, on page 3.2.137](#)
- [Exciter TCXO, on page 3.2.138](#)
- [Audio Input Calibration, on page 3.2.139](#)

Figure 3.2.106: System Settings Page

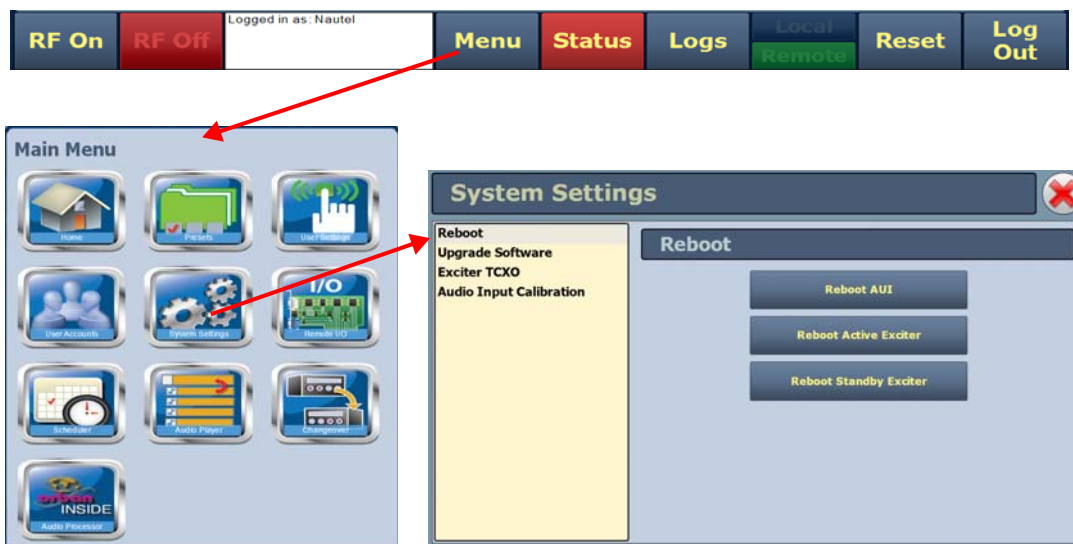

Reboot

The Reboot page (see [Figure 3.2.107](#)) allows users to reboot three items - the AUI, the active exciter and the standby exciter (if installed).

Figure 3.2.107: Reboot page

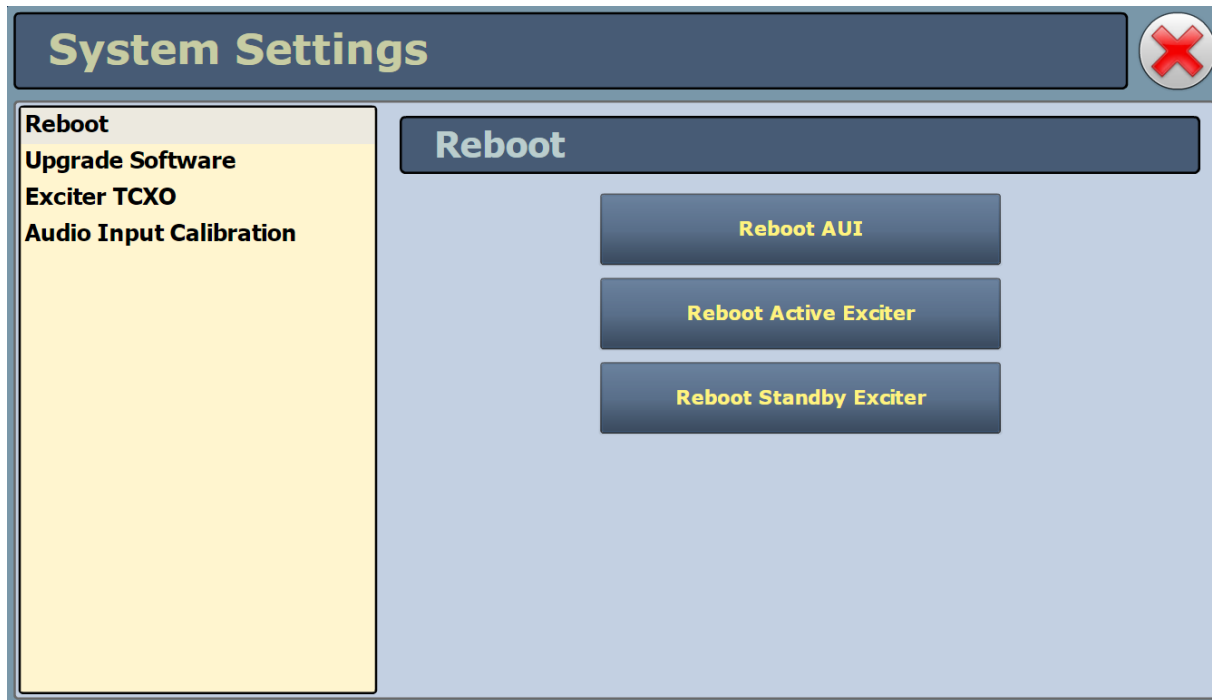

- To reboot the AUI, click the Reboot AUI button. This will function with remote control enabled or disabled. After the reboot delay, you must log in to the AUI again.
- To reset the active exciter, click the Reboot Active Exciter button, if the button is available (highlighted). NOTE: If the active exciter is reset, a brief interruption in transmitter operation will occur.
- To reset the standby exciter (for dual exciters), click the Reboot Standby Exciter button, if the button is available (highlighted).
- Click X in the upper, right corner to close this page and return to the Home page.

Upgrade Software

The Upgrade Software page (see [Figure 3.2.108](#)) allows for uploading a suite of software upgrade files (.tgz files) via remote connection. Navigate the page as described below. For additional information on loading software, see [Upgrading Software, on page 3.4.1](#).

Figure 3.2.108: Upgrade Software page

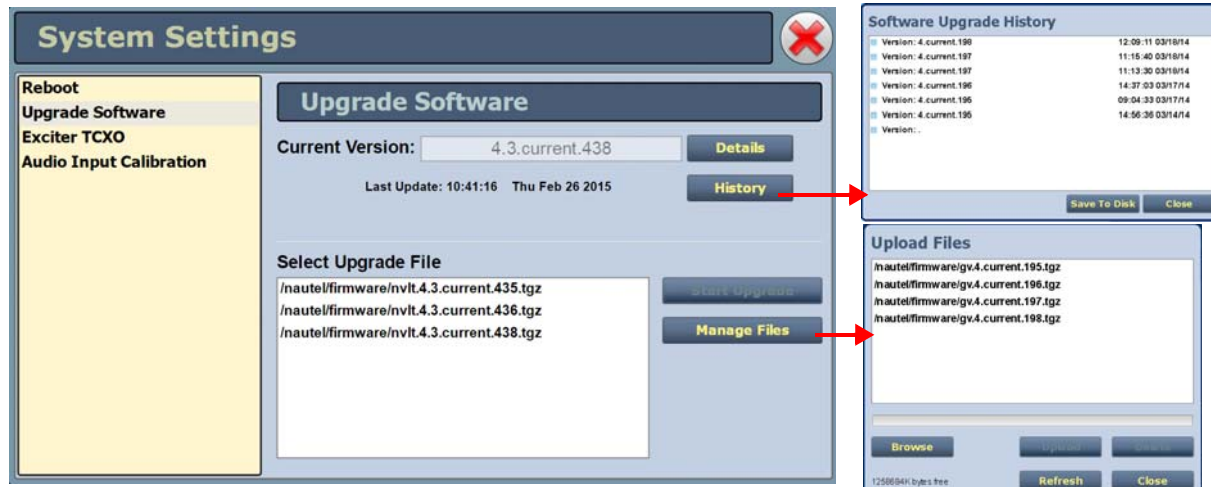

NOTE: Before performing a software upgrade, maximize the host's disk space by deleting the old .tgz files. Press the Manage Files button to display the Upload Files window, select the file(s) to delete, and press the Delete button.

Select the Upgrade Software option from the left side of the System Settings page to open a related window on the right side of the page. The page consists of the following sections and buttons:

- Current Version: indicates the current software version.
- Select Upgrade File: displays the available upgrade files uploaded to the transmitter.
- Details: opens a window containing information about the installed software. If an upgrade file is selected, the screen shows a comparison between the installed version and the selected upgrade by component. Identical versions are shown in green; different versions are shown in red. You can also view the details of the previous upgrade by clicking the View Last Upgrade checkbox.
- History: displays a window containing a history of the upgrades to the software. Click the + button to maximize the details of the software. You can save this information to disk as a .txt file from the remote AUI.
- Start Upgrade: begins to upgrade the current software with the selected upgrade file.

- **Manage Files:** opens a window displaying the files you can upload to upgrade the software. You can add or delete files from this list using the Browse, Upload and Delete buttons in the window.

NOTE: Check the Read Community and Write Community passwords after a software upgrade. Some upgrades will clear passwords and require them to be reset.

Exciter TCXO

The Exciter TCXO page (see [Figure 3.2.109](#)) allows users to calibrate the internal clock to a user supplied external high precision 10 MHz clock reference (e.g. GPS synchronized 10 MHz clock). Once this external 10 MHz clock reference is connected, the 10MHz Int-Ext Offset field will display the difference between the internal and external frequencies (in ppm). Users can press the Start button to automatically calibrate the internal TCXO to the external reference source; equally, they can manually enter the measured internal-external offset value into the TCXO Offset Value field and press Apply.

If no external high precision 10 MHz clock reference is connected, but the actual transmitter carrier frequency is being measured with a calibrated external frequency counter, operators can manually offset the internal TCXO by entering the appropriate ppm difference in the TCXO Offset Value field. For example, if the frequency of the transmitter is 1 ppm too high, then a positive 1 ppm should be entered in the TCXO Offset Value field in order to compensate. Similarly, if the transmitter frequency is too low, enter a negative ppm value. After an adjustment is made, press Apply.

To calibrate another exciter, switch to that exciter and repeat the calibration.

Figure 3.2.109: AUI - Exciter TCXO calibration page

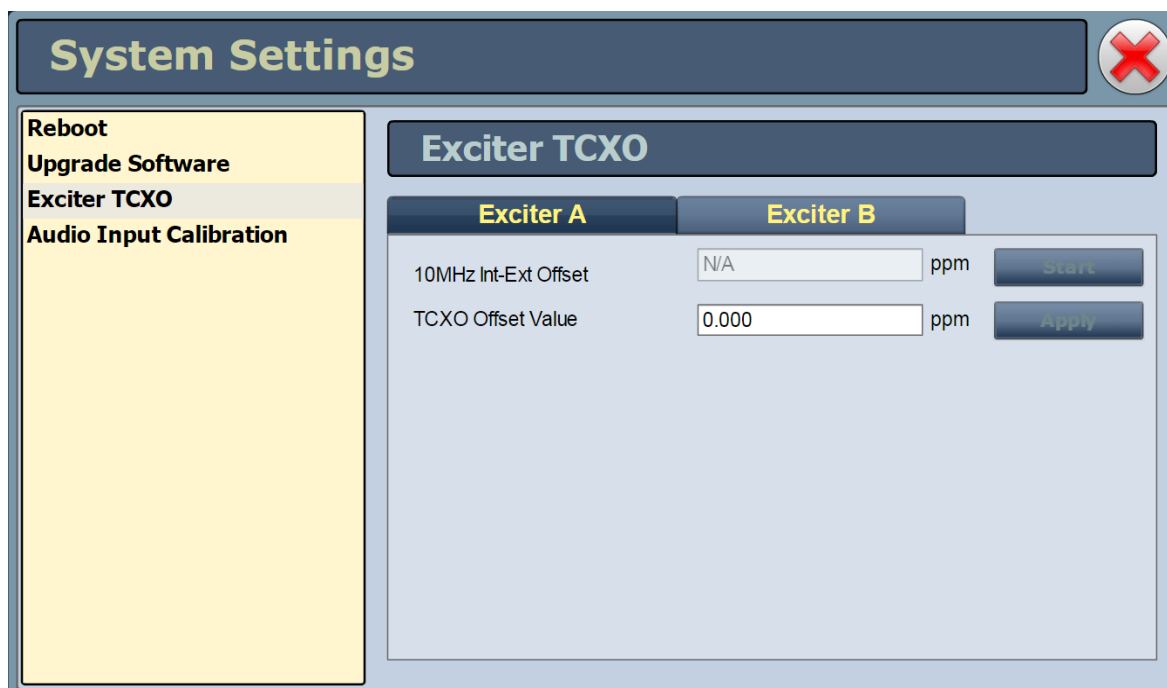

NOTE: You can also adjust the exciter TCXO offset value and run a TCXO calibration from the front panel UI (see [Setting Exciter TCXO Offset, on page 3.2.145](#)).

Audio Input Calibration

NOTE: Audio inputs are factory set using a high accuracy source and do not typically require user adjustment. Changes to factory calibrations could cause low or excessive modulation and non-compliance to strict regulatory limits. If you need to re-calibrate an audio input, make sure you have a reliable calibrated audio source.

The Audio Input Calibration page (see [Figure 3.2.110](#)) allows the user to calibrate analog and MPX (composite) audio inputs. The peak meter value of each calibrated audio input (analog left, analog right, MPX or MPX SCA, Int. SCA1 or Int. SCA2) that is applied will be displayed. Enter a valid calibration value and click Apply to save the changes. Press X in the upper, right corner to close this page and return to the home page.

Figure 3.2.110: Audio Input Calibration page

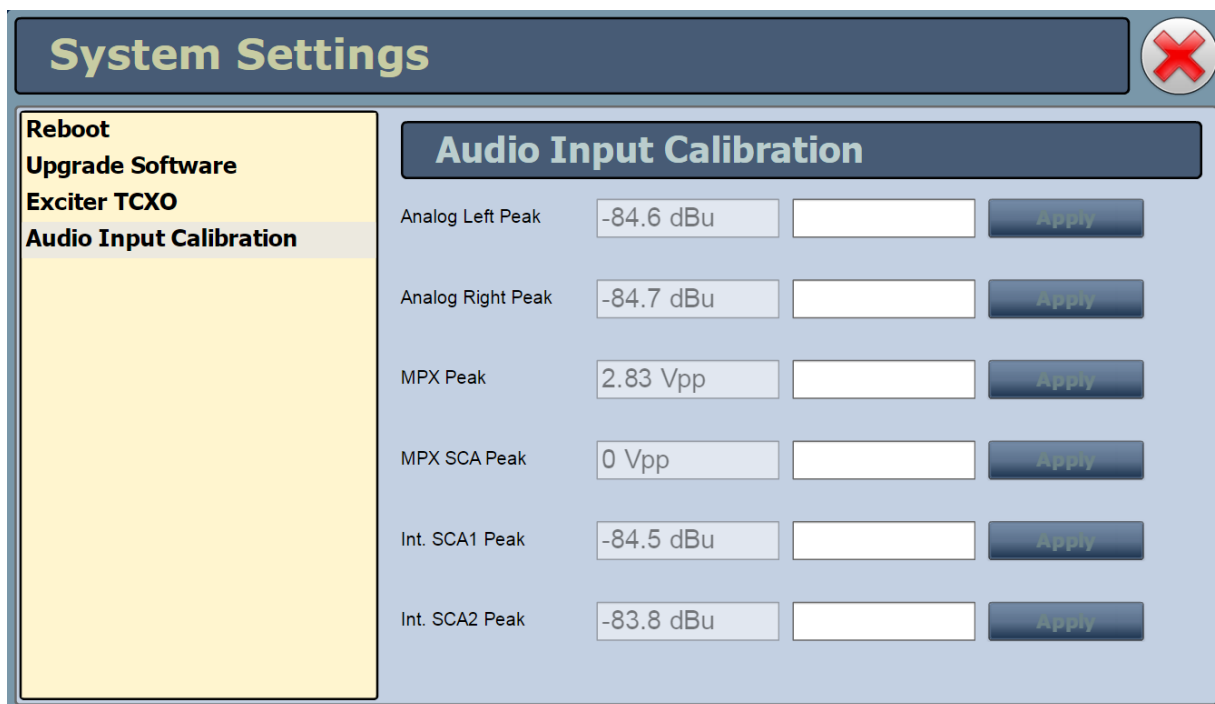

NOTE: You can also perform audio input calibration using the front panel UI (see [System Settings - using the Front Panel UI, on page 3.2.140](#)).

System Settings - using the Front Panel UI

WARNING! System settings are established at Nautel and should not require any adjustment. Making changes to these settings may void your warranty. Contact Nautel before making changes.

You can perform the following functions using the System Settings menu of the front panel UI:

- [Host Reset - see page 3.2.141](#)
- [OS Recovery - see page 3.2.141](#)
- [Configuring Host Watchdog - see page 3.2.142](#)
- Console Select (see NOTE below)
- [Updating Firmware - see page 3.2.142](#)
- [Adjusting Display Settings - see page 3.2.143](#)
- [Setting Exciter TCXO Offset - see page 3.2.145](#)
- [Configuring Installed Hardware - see page 3.2.146](#)
- [FM Polarity - see page 3.2.151](#)
- [Adjusting Factory Settings - see page 3.2.152 \(see NOTE below\)](#)

NOTE: Changing selections in the front panel UI's System Settings -> Console Select menu or the Factory Settings menu is not normally required, and should only be performed by trained personnel. Information on these sub-menus is not included in the manual. Contact Nautel for assistance.

Host Reset

NOTE: A host reset is available using the front panel display. It can also be performed from the remote AUI, using the Reboot AUI button on the Reboot page (see [Reboot](#), on page 3.2.136). Once the **host** is reset, all users that were remotely connected (logged in) will be logged out.

From the front panel UI, you can reset the host on the exciter/control PWB. To view the Host Reset screen, select System Settings -> Host Reset from the Main Menu (see [Figure 3.2.111](#)).

Figure 3.2.111: Host Reset Screen



Use the up and down buttons to toggle between Force Host Reset and Cancel. Press the accept (checkmark) button to save the change. If a reset is selected, it will occur immediately. Select Cancel or press X to abort the reset and return to the previous menu.

OS Recovery

NOTE: An OS recovery reset can restore the transmitter's operating system. It should only be required if a problem occurs during a software upgrade. This feature is only available using the front panel display.

From the front panel UI, you can perform a recovery reset of the operating system (OS). You will also need to install a flash drive, provided by Nautel, in one of the two USB ports on the rear of the controller module (A4). To view the OS Recovery screen, select System Settings -> OS Recovery from the Main Menu (see [Figure 3.2.112](#)).

Figure 3.2.112: OS Recovery Screen

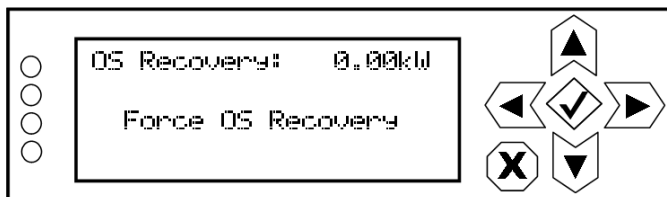

Use the up and down buttons to toggle between Force OS Recovery and Cancel. Press the accept (checkmark) button to save the change. Select Cancel or press X to abort the recovery and return to the previous menu.

Configuring Host Watchdog

NOTE: Host watchdog configuration is only available using the front panel display.

From the front panel UI, you can enable or disable the host watchdog feature. This feature, when enabled, monitors communication between the host processor and the DSP processor on the exciter/control PWB within the controller module. If communication is lost for more than 30 seconds, the transmitter will initiate an alarm and reboot the host. To view the Host Watchdog screen, select System Settings -> Host Watchdog from the Main Menu (see [Figure 3.2.113](#)).

Figure 3.2.113: Host Watchdog Screen



Use the up and down buttons to toggle between Enabled and Disabled. Press the accept (checkmark) button to save the change. Press cancel (X) to discard changes and return to the previous menu.

Updating Firmware

NOTE: A firmware update is available using the front panel UI. It can also be performed from the AUI, using the Upgrade Software page in the System Settings menu (see [Upgrade Software, on page 3.2.137](#)).

From the front panel UI, you can update firmware used in the transmitter. To perform a firmware update, select System Settings -> Firmware Update from the Main Menu (see [Figure 3.2.114](#)). The file to be used for the update can be one that was previously uploaded to the host using the AUI through the Upgrade Software page. Alternatively, you can supply the update file on a USB drive that is connected to one of the USB ports on the rear of the controller (A4).

Figure 3.2.114: Firmware Update Screen



Adjusting Display Settings

NOTE: Front panel display settings are only available using the front panel display.

From the front panel, you can configure the LCD display's contrast, brightness and backlight settings. To view the LCD Settings screen, select User Settings -> LCD Settings from the Main Menu (see [Figure 3.2.115](#)).

Figure 3.2.115: LCD Settings Menu

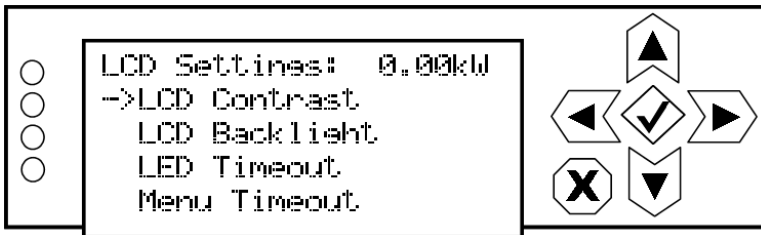

This menu has four sub-menu options:

- ❖ LCD Contrast - sets the display contrast.
- ❖ LCD Backlight - sets the brightness of the display's backlight during normal use.
- ❖ LED Timeout - sets a time delay, after a period of non-use, that the brightness of the display's backlight will dim. This feature can also be disabled.
- ❖ Menu Timeout - sets a time delay, after a period of non-use, that the front panel screen will revert back to the main menu.

Use the up and down buttons to move the cursor to the desired display setting and then press the right button to enable editing of the setting. [Figure 3.2.116 on page 3.2.144](#) shows the editing screens for the LCD Settings menu. Within any of the editing screens, use the up and down buttons to edit a setting. Press the accept (checkmark) button to save the change. Press cancel (X) to discard changes and return to the previous menu.

Figure 3.2.116: LCD Settings Editing Screens

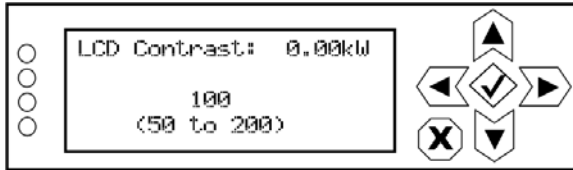

Select a value between 50 (lighter contrast) and 200 (darker contrast) (in increments of 5). Press the cancel (X) button to discard changes and return to the previous menu. Default setting is 100.

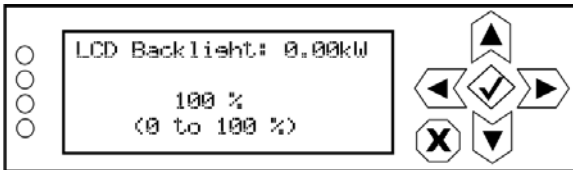

Select a value between 0 and 100% (in 5% increments). Press the cancel (X) button to discard changes and return to the previous menu. Default setting is 100%.

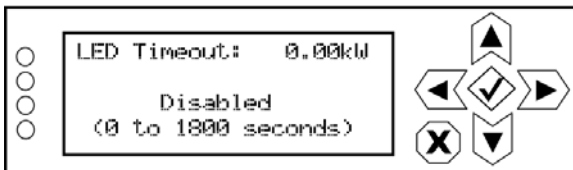

Select disabled (i.e., no timeout) or select a time period between 0 and 1800 seconds (30 minutes) (in 5 s increments). Press the cancel (X) button to discard changes and return to the previous menu. Default setting is 900 s (15 minutes).

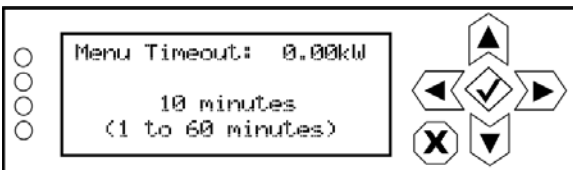

Select a time period between 1 and 60 minutes (in 1 minute increments). Press the cancel (X) button to discard changes and return to the previous menu. Default setting is 10 minutes.

Setting Exciter TCXO Offset

NOTE: You can also adjust the exciter TCXO offset value using the AUI (see [Exciter TCXO](#), on page 3.2.138).

To view the front panel UI's Exc TCXO screens (see [Figure 3.2.117](#)), select System Settings -> Exc TCXO from the Main Menu.

Figure 3.2.117: Exc TCXO screens

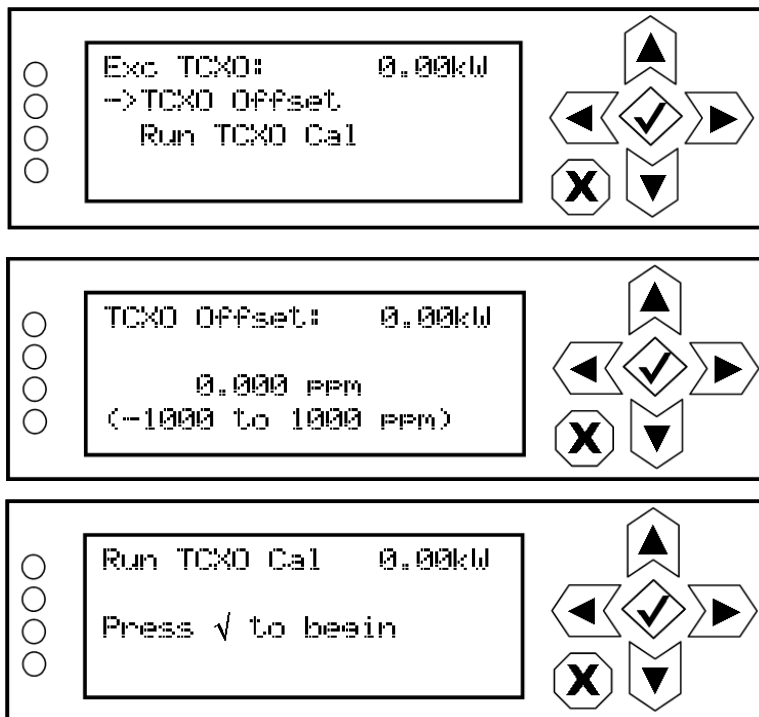

Use the up or down arrow to place the cursor next to TCXO Offset, then press the accept (checkmark) button to enter the TCXO Offset screen. Use the up and down arrows to set the TCXO offset value (in ppm) for the external 10 MHz source. When complete, press the accept (checkmark) button to save the change. Press cancel (X) to discard changes and return to the previous menu.

From the Exc TXCO menu, press the down arrow to place the cursor next to Run TCXO Cal, then press the accept (checkmark) button to enter the Run TCXO Cal screen. The calibration routine will begin when the external 10 MHz source is connected.

Configuring Installed Hardware

NOTE: Hardware configuration settings are only available using the front panel display.

From the front panel UI, you can configure the transmitter for any installed hardware that has optional variations (e.g., quantity of exciters or LVPS modules, fan speed) or is non-standard (e.g., UPS or audio processor). To view the HW Config screen, select System Settings -> HW Config from the Main Menu (see [Figure 3.2.118](#)).

NOTE: These settings are established at the factory based on the configuration that existed at time of shipping. Changes to these setting are only necessary if hardware is added or removed by the user.

Figure 3.2.118: HW Config Menu



This menu has six sub-menu options:

- ❖ [Installed Exciter - see page 3.2.147.](#)
- ❖ [LVPS Hardware - see page 3.2.147](#)
- ❖ [LVPS Voltage - see page 3.2.148](#)
- ❖ [Fan Speed - see page 3.2.149](#)
- ❖ [UPS Installed - see page 3.2.149](#)
- ❖ [Audio Processor - see \[Enabling and Operating the Orban Audio Processor\]\(#\), on page 3.2.182](#)

Installed Exciter

From the front panel UI, you can configure the transmitter for the number of installed exciters. If you have upgraded your transmitter to dual exciters, you may have already been prompted to change this configuration. To view the Installed Exc screen, select System Settings -> HW Config -> Installed Exc from the Main Menu (see [Figure 3.2.119](#)).

Figure 3.2.119: Installed Exciter Screen

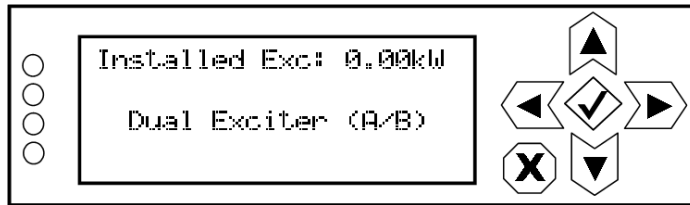

Use the up and down buttons to select the appropriate exciter configuration - Exciter (A) or Dual Exciter (A/B). Press the accept (checkmark) button to save the change. Press X to abort the change and return to the previous menu.

LVPS Hardware

From the front panel UI, you can configure the transmitter for the number of installed LVPS modules. If you have upgraded your transmitter to dual LVPS modules, you may have already been prompted to change this configuration. To view the LVPS Hardware screen, select System Settings -> HW Config -> LVPS Hardware from the Main Menu (see [Figure 3.2.120](#)).

Figure 3.2.120: LVPS Hardware Screen

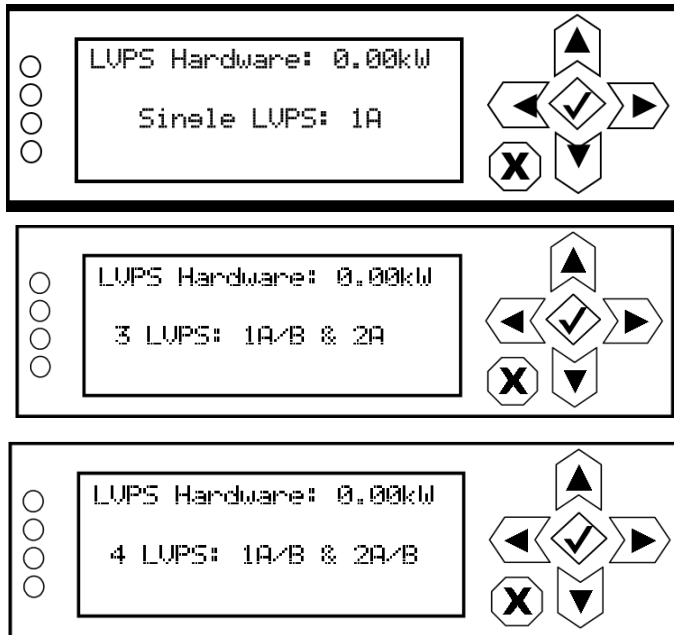

Use the up and down buttons to select the appropriate LVPS configuration - Single LVPS: 1A or Single LVPS: 1B or Dual LVPS: 1A/1B, 3 LVPS: 1A/B & 2A, or 4 LVPS: 1A/B & 2A/B. Press the accept (checkmark) button to save the change. Press X to abort the change and return to the previous menu.

LVPS Voltage

From the front panel UI, you can set the default LVPS voltage. The transmitter will set the LVPS voltage to this value (between 40 and 53 V, in 1 V steps) during normal operation. Under fault conditions, if the LVPS voltage requires an increase, the control system automatically increases the LVPS voltage, then decreases it back to the set value when the fault condition clears. This setting should not require adjustment.

To view the LVPS Voltage screen, select System Settings -> HW Config -> LVPS Voltage from the Main Menu (see [Figure 3.2.121](#)).

Figure 3.2.121: LVPS Voltage Screen

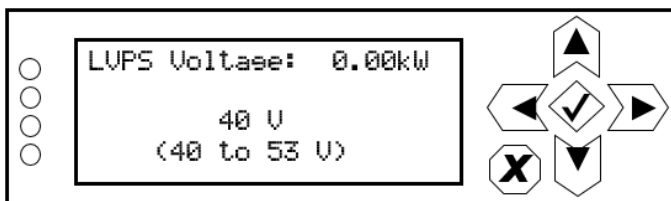

Use the up and down buttons to select a voltage between 40 and 53 V (in 1 V steps). The default setting is 40 V. Press the accept (checkmark) button to save the change. If a reset is selected, it will occur immediately. Press X to abort the change and return to the previous menu.

Fan Speed

The transmitter control function automatically adjusts fan speed to ensure adequate cooling based on all operating conditions. As a result this setting should not require adjustment. Increasing the fan speed will allow for cooler transmitter operation, but will also decrease efficiency and increase acoustic noise levels.

From the front panel UI, you can set the default speed of the transmitter's cooling fans. The transmitter will set the fan speed to a percentage (between 63 and 100%) of the maximum speed during normal operation. Under fault conditions, the control system determines if an increase or decrease in fan speed is required and automatically adjusts the fan speed.

To view the Fan Speed screen, select System Settings -> HW Config -> Fan Speed from the Main Menu (see [Figure 3.2.122](#)).

Figure 3.2.122: Fan Speed Screen

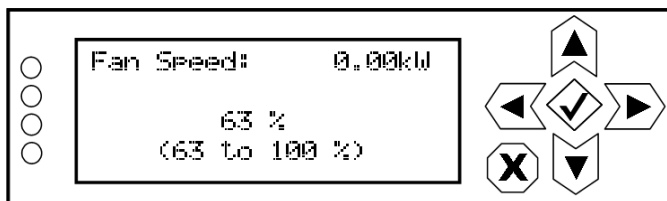

Use the up and down buttons to select a value between 63 and 100 %. The default setting is 63%, which corresponds to approximately 31 V for the related fan voltage. A setting of 100% corresponds to approximately 48 V for the related fan voltage. Press the accept (checkmark) button to save the change. Press X to abort the change and return to the previous menu.

NOTE: A 20% reduction in fan speed can yield up to 5 dB improvement in acoustic noise from the transmitter, as well as decrease power consumption (i.e., utility costs) and extend the operating life of the cooling fans.

UPS Installed

From the front panel UI, you can configure the transmitter for the installation of the UPS interface kit, which allows operation with an external, user-provided UPS. If you have upgraded your transmitter with the UPS interface, you may have already been prompted to change this configuration. To view the UPS Installed screen, select System Settings -> HW Config -> UPS Installed from the Main Menu (see [Figure](#)).

Figure 3.2.123: UPS Installed Screen

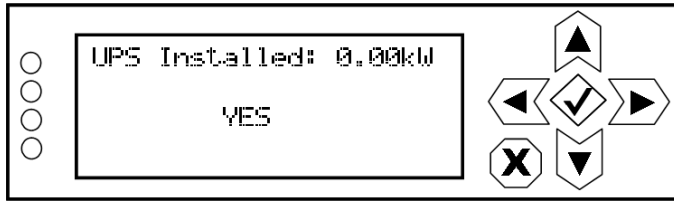

Use the up and down buttons to toggle between NO (no UPS interface installed) and YES (UPS interface is installed). Press the accept (checkmark) button to save the change. Press X to abort the change and return to the previous menu.

FM Polarity

NOTE: Adjusting FM polarity is used to synchronize transmitters for a single-frequency network. It determines whether positive audio input results in positive or negative modulation. This feature is only available using the front panel UI.

From the front panel UI, you can set the FM polarity. To view the FM Polarity screen, select System Settings -> FM Polarity from the Main Menu (see [Figure 3.2.124](#)).

Figure 3.2.124: FM Polarity Screen

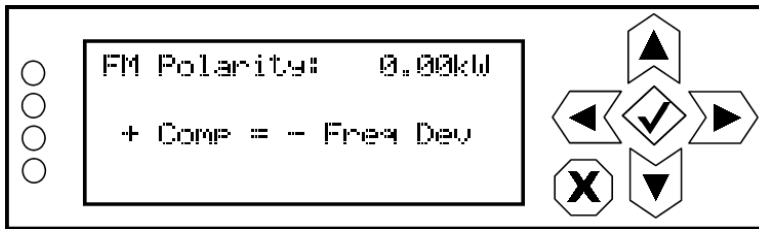

Use the up and down buttons to toggle between + Comp = - Freq Dev and + Comp = + Freq Dev. The default setting is + Comp = - Freq Dev . Press the accept (checkmark) button to save the change. Press X to abort the change and return to the previous menu.

Adjusting Factory Settings

NOTE: Factory Settings are only available using the front panel UI.

CAUTION! Changing values in the System Settings -> Factory Settings menu is not normally required, and should only be performed by trained personnel. Information on some of these sub-menus is not included in the manual. Contact Nautel for assistance.

From the front panel UI, you can adjust various factory settings such as critical parameter thresholds, calibration values, exciter power level, etc. To view the Factory Settings menu (see [Figure 3.2.125](#)), select System Settings -> Factory Settings from the Main Menu.

Figure 3.2.125: Factory Settings Menu

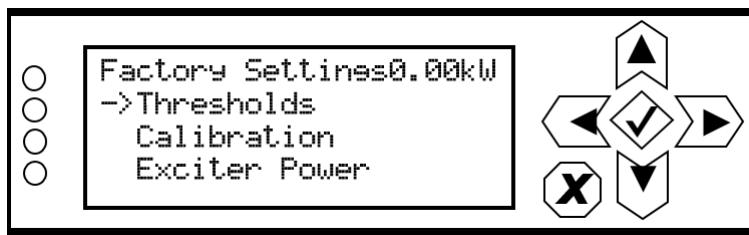

This menu has three sub-menu options:

- ❖ [Thresholds](#) - see page 3.2.153
- ❖ [Calibration](#) - see page 3.2.154 (see IMPORTANT note below)
- ❖ [Exciter PA Power](#) - see page 3.2.155

IMPORTANT! The Calibration menu (see [Calibration](#), on page 3.2.154) contains a Xmtr PA Bias routine that must be initiated after any of the following events:

- ❖ A new RF power module has been installed in the transmitter
- ❖ RF power modules have swapped positions
- ❖ A new controller module has been installed in the transmitter

Thresholds

NOTE: Threshold settings are only available using the front panel UI.

WARNING! Threshold settings are established at the factory and should not require any adjustment. These settings affect critical system protection circuits. Making changes to these settings may void your warranty. Contact Nautel before making changes.

From the front panel UI, you can set alarm thresholds for critical parameters. To view the Thresholds menu (see [Figure 3.2.126](#)), select System Settings -> Factory Settings -> Thresholds from the Main Menu.

Figure 3.2.126: Thresholds Menu

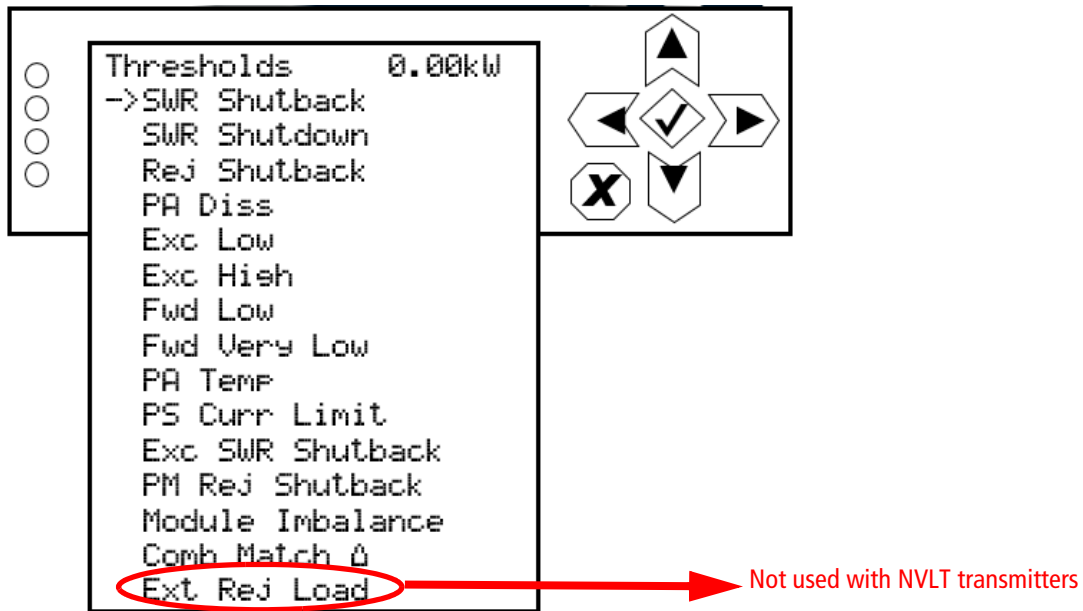

Calibration

NOTE: Most of the Calibration settings are only available using the front panel UI. Calibration of audio related parameters (see [Figure 3.2.127](#)) can also be performed using the AUI (see [Audio Input Calibration](#), on page 3.2.139).

From the front panel UI, you can calibrate various parameters. To view the Calibration menu (see [Figure 3.2.127](#)), select System Settings -> Factory Settings -> Calibration from the Main Menu.

Figure 3.2.127: Calibration Menu

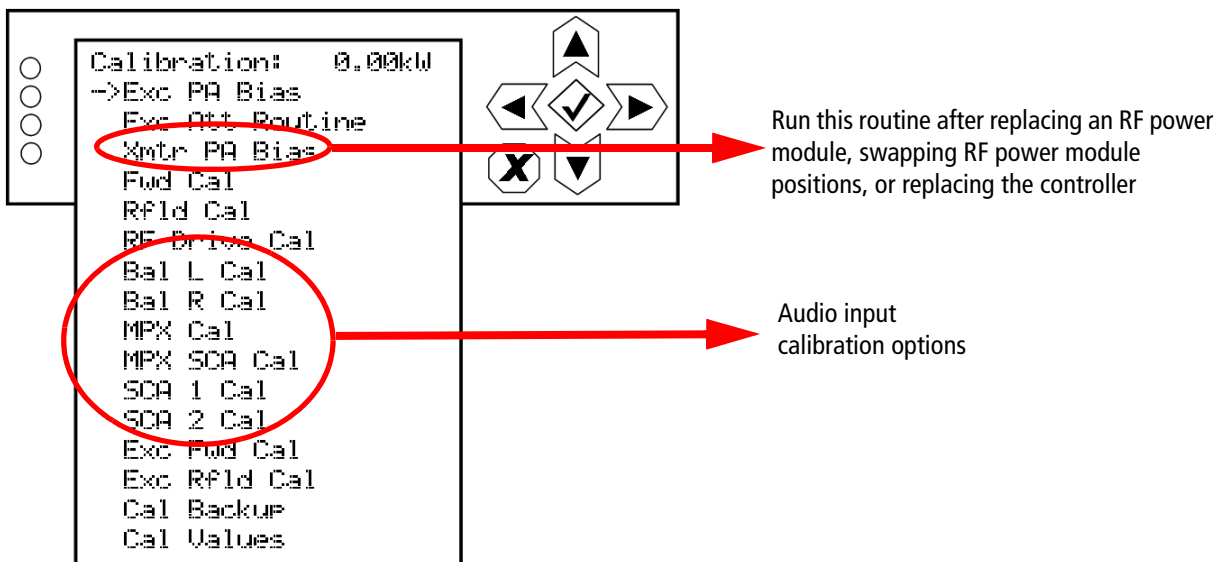

RUNNING THE XMTR PA BIAS ROUTINE. You must run the transmitter’s PA bias routine immediately after one of the following events:

- ❖ installation of a new RF power module
- ❖ swapping of existing RF power modules
- ❖ installation of a new controller module

NOTE: Make sure that the RF stage is disabled (RF Off) and the interlock circuit is closed before running the PA bias routine. If not, a message will appear on the display prompting you to do so.

Use the up or down arrow to place the cursor next to Xmtr PA Bias, then press the accept (checkmark) button to enter the sub-menu. Within the sub-menu, press the accept (checkmark) button to start the routine. A line will display the percentage of completion. When it is complete, the display will again read “Press ✓ to begin”. Press X to return to the previous menu.

CALIBRATING AUDIO INPUTS. Use the up or down arrow to place the cursor next to the desired audio input calibration item (Bal L Cal, Bal R Cal, MPX Cal, MPX SCA Cal, SCA 1 Cal or SCA 2 Cal), then press the accept (checkmark) button to enter the selected audio input. With the appropriate calibrated audio source(s) applied, use the up and down arrows to set the new calibration value for the selected audio input. When complete, press the accept (checkmark) button to save the change. Press cancel (X) to discard changes and return to the previous menu.

NOTE: Forward power (Fwd Cal), reflected power (Refld Cal), RF Drive, exciter forward (Exc Fwd) and exciter reflected (Exc Rfld) calibrations are performed at the factory and should not require user adjustment. Contact Nautel for assistance, if necessary.

Exciter PA Power

NOTE: The exciter PA power setting is only available using the front panel UI.

From the front panel UI, you can set the exciter’s PA power level at 98 MHz. To view the Exciter PA Power screen, select System Settings -> Factory Settings -> Exciter PA Power from the Main Menu (see Figure 3.2.128). The transmitter automatically compensates the actual exciter PA power level based on the operating frequency so there should be no need to adjust this value.

Figure 3.2.128: Exciter Power Screen

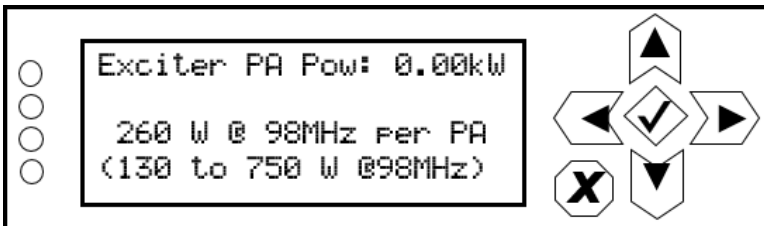

Use the up and down buttons to select a power level between **130** and **750** W (in 1 W increments). Press the accept (checkmark) button to save the change. Press X to abort the change and return to the previous menu.

Configuring Remote Inputs and Outputs

You can configure your remote input/output interface for the transmitter using the remote AUI (see [Remote I/O Settings - Using the AUI](#)) or using the local front panel display (see [Remote I/O Settings - Using the Front Panel Display, on page 3.2.162](#)).

Refer also to the NV20LT/NV15LT Pre-installation Manual for information on remote inputs and outputs and their factory default settings.

Remote I/O Settings - Using the AUI

To view the Remote I/O page (see [Figure 3.2.129](#)), select Remote I/O from the Menu options. Click X in the upper, right corner to close this page and return to the home page.

Figure 3.2.129: Remote I/O Page (Inputs tab selected)

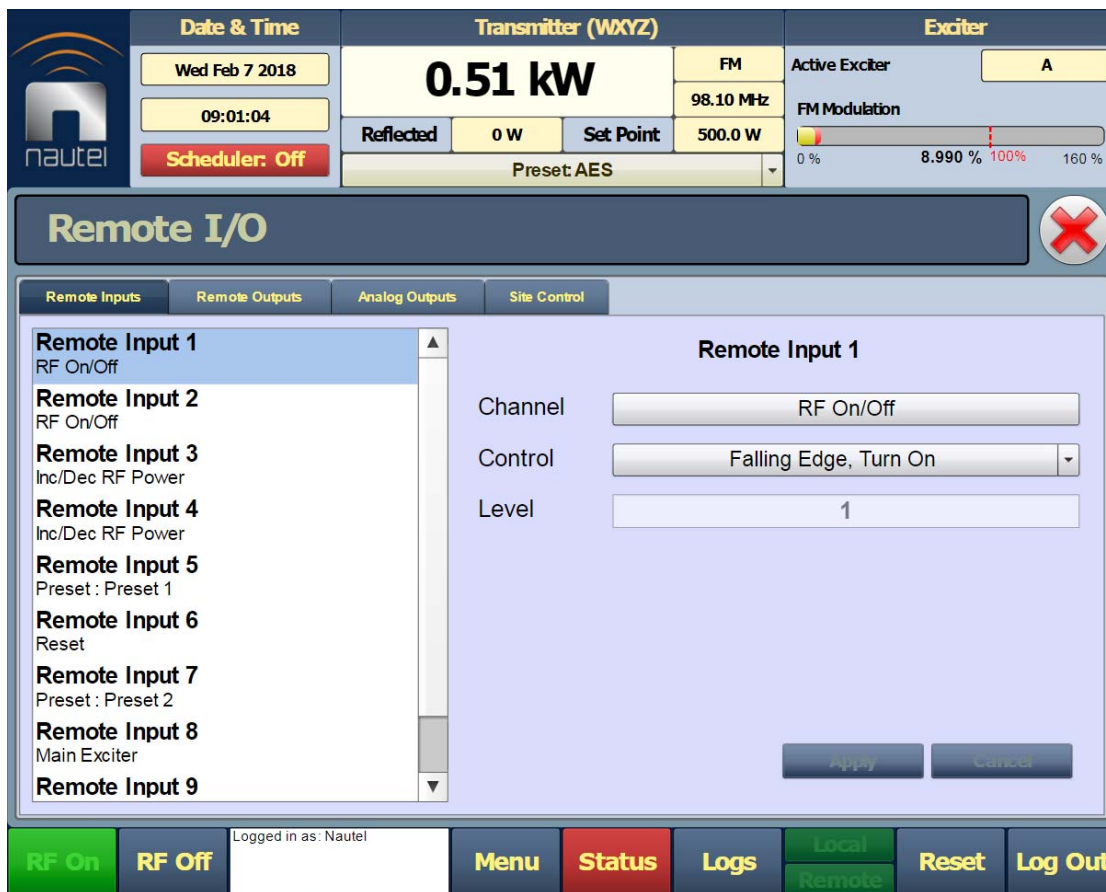

Click the Remote Inputs (see [Remote Inputs - AUI, on page 3.2.157](#)) or Outputs (see [Remote Outputs - AUI, on page 3.2.159](#)) tab to view or edit detail on the **remote** inputs or outputs.

Remote Inputs - AUI

Using the Remote Inputs tab (see [Figure 3.2.129 on page 3.2.156](#)), you can configure up to 10 remote inputs that allow you to remotely control various operational characteristics of the transmitter. Unless otherwise noted, these inputs are only accepted by the transmitter if the remote/local status is set to remote. That setting can only be made by a local user using the front panel UI. Nautel sets remote input defaults prior to shipping. See the Pre-installation Manual for details.

Select the desired remote input (1 through 10) from the list. The Channel and Control settings for the selected input, as well as the current logic level (1 or 0), are displayed on the right-hand side of the page. You can define the Channel and Control settings as follows:

SELECT INPUT CHANNEL - AUI

You can configure remote inputs 1 through 10 for one of a variety of control inputs. Press the existing Channel bar to display the Select a Remote window (see [Figure 3.2.130 on page 3.2.158](#)). From this window select one of the following options by pressing OK:

- ❖ Not Assigned. No effect on transmitter operation, regardless of logic level.
- ❖ RF On/Off. Same as pressing the RF On (telling the system to provide RF power, if possible) or the RF Off button on the local AUI. There are two inputs configured by default; one for Falling Edge, Turn On and one for Falling Edge, Turn Off.
- ❖ Reset. Causes a system reset. Same as pressing Reset button on the local AUI.
- ❖ Force Host Reboot. Allows the user to force a host (SBC) reset to the AUI, thus rebooting the AUI via a hardware parallel remote input (controlled by a third party remote control unit).
- ❖ Main Exciter. Selects the main exciter to operate the transmitter. There are two inputs configured by default; one for Falling Edge, Set to A and one for Falling Edge, Set to B.
- ❖ Auto Changeover. Sets the exciter changeover function to operate automatically. There is only one input configured by default; each subsequent activation of the input will toggle the state (enabled/disabled) e.g. Falling Edge, Toggle.
- ❖ Inc/Dec RF Power. Activating these inputs will increment/decrement the preset power level by 1% of the rated power. Holding the selection will increment/decrement the power level by 1% every 1/2 second. There are two inputs configured by default; one for Falling Edge, Increase and one for Falling Edge, Decrease. **NOTE:** If multiple power increase or decrease inputs are active, the lower number input takes precedence.
- ❖ Preset: NAME. Selects the associated preset (from a list of all pre-defined presets) as active.

If you save a change to a remote input via the AUI, it will also be displayed on the front panel UI.

Figure 3.2.130: Select a Remote (input) window

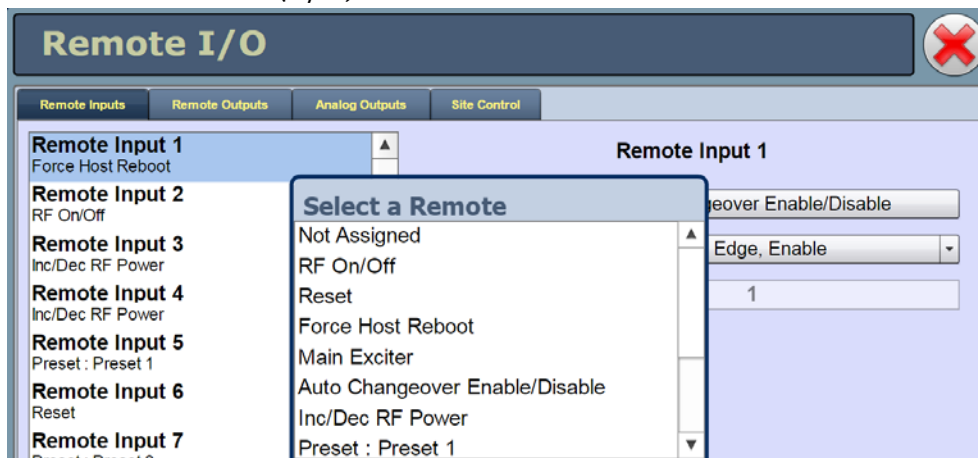

CONFIGURE INPUT CONTROL LOGIC - AUI

You can configure the active/inactive control logic for each of the 10 remote inputs. Click the existing Logic bar to display the applicable drop-down menu options, which may include:

- ❖ Rising Edge Turn On/Reset. Logic '1' (high or rising edge) activates the input (or causes a reset, as appropriate).
- ❖ Falling Edge Turn On/Reset. Logic '0' (low or trailing edge) activates the input (or causes a reset, as appropriate).
- ❖ Rising Edge Turn Off. Logic '1' (high or rising edge) de-activates the input.
- ❖ Falling Edge Turn Off. Logic '0' (low or trailing edge) de-activates the input.
- ❖ Falling Edge Toggle. Logic '0' (low or trailing edge) de-activates the input; next logic '0' (low or trailing edge) activates the input.
- ❖ Rising Edge Toggle. Logic '1' (high or rising edge) activates the input; next logic '1' (high or rising edge) de-activates the input.
- ❖ Rising Edge, Turn On. Falling Edge Turn Off. Logic '1' (high or rising edge) activates the input; logic '0' (low or trailing edge) de-activates the input.
- ❖ Falling Edge, Turn On. Rising Edge Turn Off. Logic '0' (low or trailing edge) activates the input; logic '1' (high or rising edge) de-activates the input.
- ❖ Active High, Increase/Turn On. Logic '1' (high) causes a power increase/activates preset.
- ❖ Active Low, Increase/Turn On. Logic '0' (low) causes a power increase/activates preset.
- ❖ Active High, Decrease. Logic '1' (high) causes a power decrease.
- ❖ Active Low, Decrease. Logic '0' (low) causes a power decrease.

Click Apply to activate changes. Click Undo to cancel changes.

Remote Outputs - AUI

Using the Remote Outputs tab (see [Figure 3.2.131](#) on page 3.2.159, you can configure up to 16 remote outputs that indicate either the presence of various alarms or the status of operator controlled circuits.

Nautel sets remote output defaults prior to shipping. See the NV20LT/NV15LT Pre-installation Manual for details.

Figure 3.2.131: Remote I/O Page - Remote Outputs tab selected

The screenshot displays the Nautel transmitter control interface. At the top, there are sections for Date & Time (Thu Aug 14 2014, 14:59:17), Transmitter (0.01 kW, 98.10 MHz, 22.00 kW Set Point), and Exciter (Active Exciter A, FM Modulation 0.010%). Below this is the 'Remote I/O' section with tabs for Remote Inputs, Remote Outputs, Analog Outputs, and Site Control. The Remote Outputs tab is active, showing a list of 9 remote outputs on the left and configuration details for 'Remote Output 2' on the right. The list includes: Remote Output 1 (Not Assigned), Remote Output 2 (External Interlock Open), Remote Output 3 (High Temperature Summary), Remote Output 4 (External Summary), Remote Output 5 (Low Forward Power), Remote Output 6 (High Reflected Summary), Remote Output 7 (Power Amplifier Summary), Remote Output 8 (Power Supply Summary), and Remote Output 9. The configuration for Remote Output 2 shows Channel: External Interlock Open, Control: Output Low When True, and Level: 0. At the bottom, there are buttons for RF On/Off, Menu, Status, Logs, Local/Remote, Reset, and Log Out.

Select the desired remote output (1 through 16) from the list. The Channel and Control settings for the selected output, as well as the current logic level (1 or 0), are displayed on the right-hand side of the page. You can define the Channel and Control settings as follows:

SELECT OUTPUT CHANNEL - AUI

You can configure remote outputs 1 through 16 to monitor a variety of alarm and status outputs. Press the existing Channel bar to display the Select a remote window (see Figure 3.2.132). From this window, select one of the channels, then click OK to accept:

- ❖ Not Assigned. No alarm or status parameter is monitored.
- ❖ Remote Enabled. An active logic low level indicates remote control is enabled (i.e. local plus remote). The inactive logic level indicates remote control is disabled.
- ❖ RF On/Off. The active logic level indicates the transmitter’s RF power stage is on (enabled). The inactive logic level indicates the transmitter’s RF power stage is off.
- ❖ Preset Status (1-3 default). The active preset’s output will be indicated by a logic low. The remaining, non-active preset outputs will be open collector.
- ❖ Active Exciter. The active exciter’s output will be indicated by a logic low. The other, non-active exciter output (as applicable), will be open collector.
- ❖ Auto Changeover. The output will be a logic low when auto changeover is enabled or disabled, as defined by the control logic.
- ❖ Various Alarms. The active logic level indicates that the selected alarm is occurring. Any transmitter alarm can be selected as a remote output. Refer to the NV20LT/NV15LT Troubleshooting Manual for a description of each alarm.
- ❖ Audio Active. The selected output (MPX, AES 1, AES 2 or L/R) will be a logic low when the associated audio path is active.

Figure 3.2.132: Select a Remote (output) window

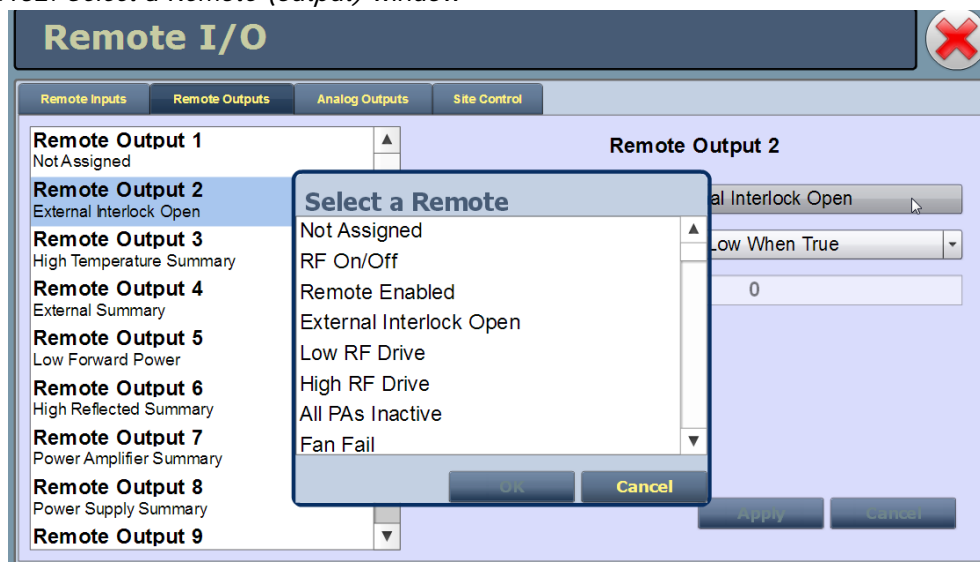

CONFIGURE OUTPUT LOGIC - AUJ

You can configure the active/inactive logic for each of the 16 remote outputs. Click the existing Logic bar to display the applicable drop-down menu options. Some remote output default examples:

If the selected channel is RF On/Off, the drop-down options are:

- Output Low When RF On. Logic '0' (low) indicates the output is true (RF is on); Logic '1' (high) indicates the output is false (RF is off).
- Output Low When RF Off. Logic '0' (low) indicates the output is true (RF is off); Logic '1' (high) indicates the output is false (RF is on).

If the selected channel is Remote Enabled, the drop-down options are:

- Output Low When True. Logic '0' (low) indicates the remote access is enabled; Logic '1' (high) indicates the remote access is disabled.
- Output Low When False. Logic '0' (low) indicates the remote access is disabled; Logic '1' (high) indicates the remote access is enabled.

If the selected channel is Active Exciter, the drop-down options are:

- Output Low When A. Logic '0' (low) indicates the output is true (A); Logic '1' (high) indicates the output is false (B).
- Output Low When B. Logic '0' (low) indicates the output is true (B); Logic '1' (high) indicates the output is false (A).

if the selected channel is Auto Changeover, the drop-down options are:

- Output Low When Enabled. Logic '0' (low) indicates the output is true (Enabled); Logic '1' (high) indicates the output is false (Disabled).
- Output Low When Disabled. Logic '0' (low) indicates the output is true (Disabled); Logic '1' (high) indicates the output is false (Enabled).

if the selected channel is Preset: Preset 1, the drop-down options are:

- Output Low When Active. Logic '0' (low) indicates the output is true (Active); Logic '1' (high) indicates the output is false (Inactive).
- Output Low When Inactive. Logic '0' (low) indicates the output is true (Inactive); Logic '1' (high) indicates the output is false (Active).

Click Apply to activate changes. Click Cancel to cancel changes.

Remote I/O Settings - Using the Front Panel Display

To view the Remote I/O screen (see [Figure 3.2.133](#)) on the front panel display, select User Settings -> Remote I/O from the Main Menu.

Figure 3.2.133: Remote I/O screen

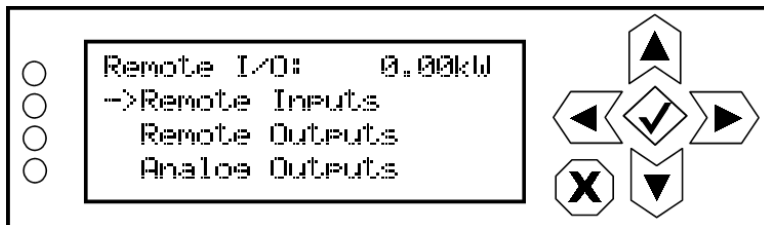

Use the up and down buttons to select Remote Inputs (see [Remote Inputs - Front Panel](#), on page [3.2.162](#)), Remote Outputs (see [Remote Outputs - Front Panel](#), on page [3.2.164](#)) or Analog Outputs (see [Monitoring Analog Outputs](#), on page [3.2.165](#)) to view or edit detail on the selected inputs or outputs.

Remote Inputs - Front Panel

Using the Remote Inputs screens (see [Figure 3.2.134](#) on page [3.2.163](#)), you can configure up to 10 remote inputs that allow you to remotely control various operational characteristics of the transmitter. Unless otherwise noted, these inputs are only accepted by the transmitter if remote control is enabled. That setting can only be made by a local user using the front panel UI.

Nautel sets remote input defaults prior to shipping. See the NV20LT/NV15LT Pre-installation Manual for details.

Figure 3.2.134: Remote Inputs Screens (Input 1 shown)

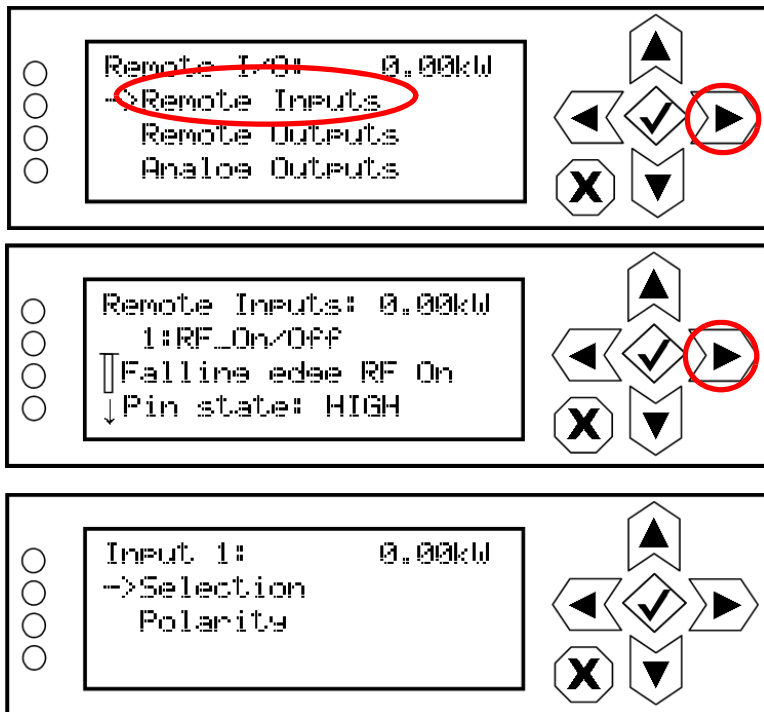

Use the up and down buttons to select the desired remote input (1 through 10) from the list. Each screen shows the current remote input parameter (e.g., RF On/Off), as well as the polarity (e.g., Falling edge RF On) and current state (e.g., high, low) of the corresponding input pin. Use the right-arrow button to enter the Selection/Polarity screen for the selected input to allow editing of the selection or the polarity. Press cancel (X) to return to the previous menu.

If you save a change to a remote input via the front panel UI, it will also be displayed on the AUI page.

NOTE: The selection and polarity options for remote inputs are the same as described in [Select Input Channel - AUI, on page 3.2.157](#) and [Configure Input Control Logic - AUI, on page 3.2.158](#).

Remote Outputs - Front Panel

Using the Remote Outputs screens (see [Figure 3.2.135 on page 3.2.164](#)), you can configure up to 16 remote outputs that indicate either the presence of various alarms or the status of operator controlled circuits.

Nautel sets remote output defaults prior to shipping. See the NV20LT/NV15LT Pre-installation Manual for details.

Figure 3.2.135: Remote Outputs Screens (Output 1 shown)

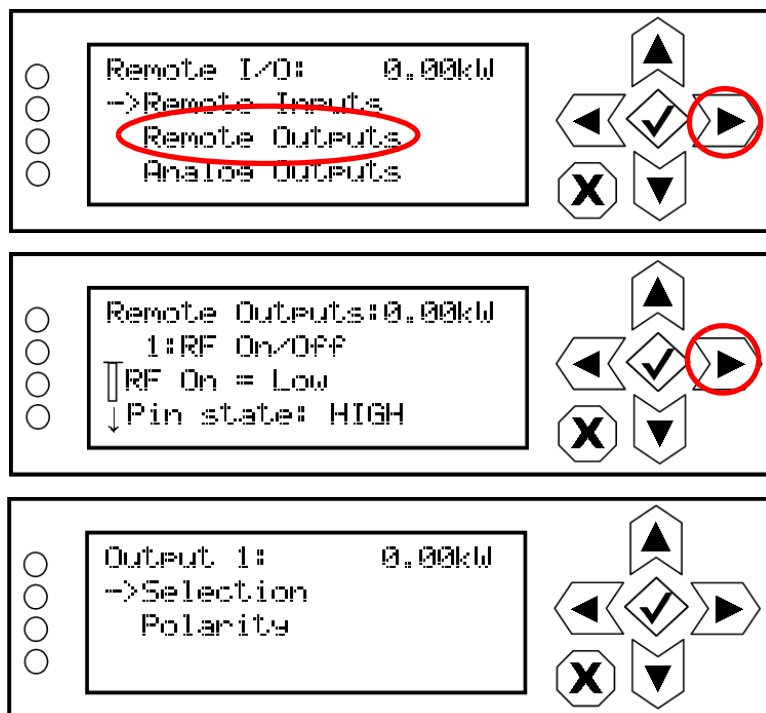

Use the up and down buttons to select the desired remote output (1 through 16) from the list. Each screen shows the current remote output parameter (e.g., RF On/Off), as well as the polarity (e.g., RF On = Low) and current state (e.g., high, low) of the corresponding output pin. Use the right-arrow button to enter the Selection/Polarity screen for the selected output to allow editing of the selection or the polarity. Press cancel (X) to return to the previous menu.

If you save a change to a remote output via the front panel UI, it will also be displayed on the AUI page.

NOTE: The selection and polarity options for remote outputs are the same as described in [Select Output Channel - AUI, on page 3.2.160](#) and [Configure Output Logic - AUI, on page 3.2.161](#).

Monitoring Analog Outputs

There are four analog outputs - forward power, reflected power, average PA voltage and total PA current - that can be remotely monitored using the AUI (see [Analog Outputs - AUI](#)) or using the front panel UI (see [Analog Outputs - Front Panel, on page 3.2.166](#)). These outputs are factory defined parameters (cannot be changed to other parameters), however their scaling can be configured to reflect the output voltage that yields a full-scale deflection.

The values associated with each of these fixed meters are of a linear nature so that changes made to the Sample Full Scale field (allowable range is 1- 6 V, defaulted to 6 V) will be reflected in the other fields according to the following equation:

$$(\text{Meter Value}/\text{Meter Full Scale}) \times \text{Sample Full Scale} = \text{Sample Voltage}$$

NOTE: The Sample Voltage reading reflects the value that can be measured at the associated remote analog output pin for the given Meter Value. See the NV20LT/NV15LT Pre-installation Manual for actual remote analog output pin assignments.

Analog Outputs - AUI

Select the Analog Outputs tab to view the analog outputs (see [Figure 3.2.136](#)) for the pre-determined parameters. There are columns that list the Full Scale Voltage and corresponding Full Scale Value as well as the Current Voltage and corresponding Current Value.

Figure 3.2.136: Remote I/O Page - Analog Outputs tab selected



Press Apply to activate changes. Press Cancel to discard changes.

Analog Outputs - Front Panel

Using the Analog Outputs screens (see [Figure 3.2.134 on page 3.2.163](#)), you can view the levels of four pre-defined analog outputs that are representative of critical transmitter parameters.

Nautel sets analog output defaults prior to shipping. There are no configuration options. They are for monitoring purposes only. See the NV20LT/NV15LT Pre-installation Manual for details.

Figure 3.2.137: Analog Outputs Screens

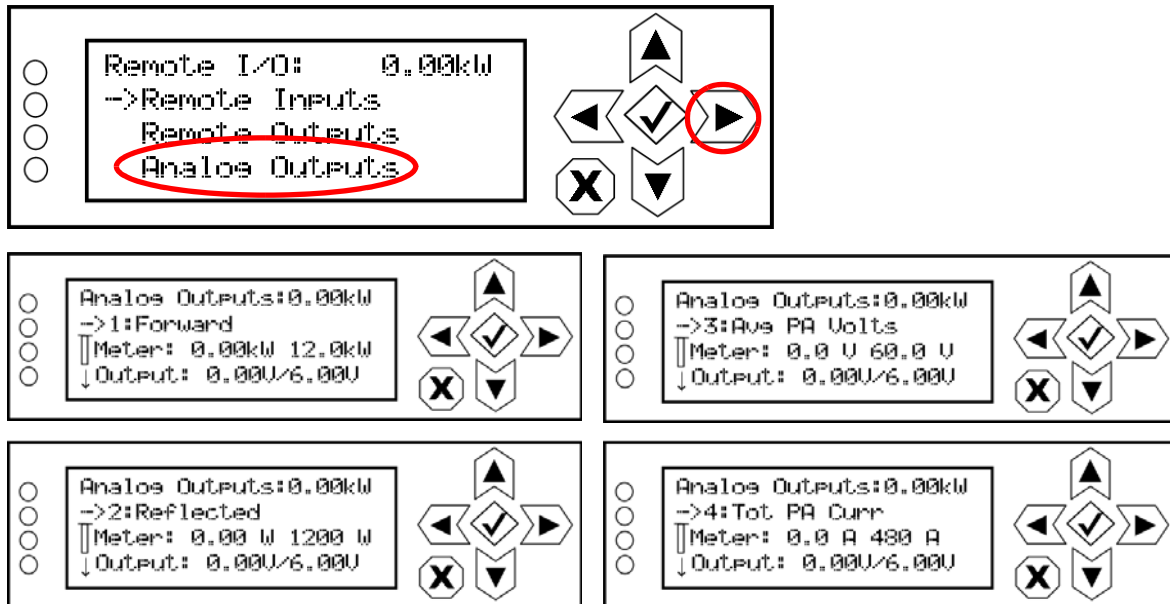

Use the up and down buttons to select the desired analog output (1 through 4) from the list. Each screen shows the analog output parameter (e.g., Forward Power, Reflected Power, Avg PA Volts or Total PA Current), as well as the meter reading (actual and full-scale) and the output pin voltage (actual and full-scale). Press cancel (X) to return to the previous menu.

NOTE: The analog output's Output voltage reading reflects the value that can be measured at the associated remote analog output pin for the given Meter value. See the Pre-installation Manual for actual remote analog output pin assignments.

Site Control Settings

You can use the remote AUI's Site Control page (see [Figure 3.2.138](#)) to locally or remotely configure remote inputs and outputs for use with external site control equipment (air conditioner, etc.). This page allows the user to create and configure custom digital inputs and outputs and assign them for use using the Remote Inputs and Remote Outputs pages.

To view this page, select Remote I/O from the Menu options and select the Site Control tab. Press X in the upper, right corner to close this page and return to the Home page.

Figure 3.2.138: Remote I/O Page - Site Control

Name	Severity	Latch	Log	Delay	Triggered When	State
Test	Low	<input type="checkbox"/>	<input checked="" type="checkbox"/>	Immediate	Controller:Test Is True	<input checked="" type="checkbox"/>

Adding or Editing a Site Control Rule

Selecting the Add or Edit button displays the rule editing window (see [Figure 3.2.139](#) on page 3.2.168) for site control inputs and outputs. This window allows you to create a new site control rule or edit an existing one. Each custom input or output can be assigned a name, severity level and trigger parameters (active state and time delay). Each rule can also be set to latch (i.e., requiring a reset) or log with the rest of the transmitter's alarm and status signals, upon its occurrence. You can use Boolean logic expressions to perform 'AND', 'OR' and 'XOR' (exclusive OR) functions on multiple inputs or rules.

Use the Edit Site Control Rule window as follows:

Figure 3.2.139: Site Control Rule Editing Window

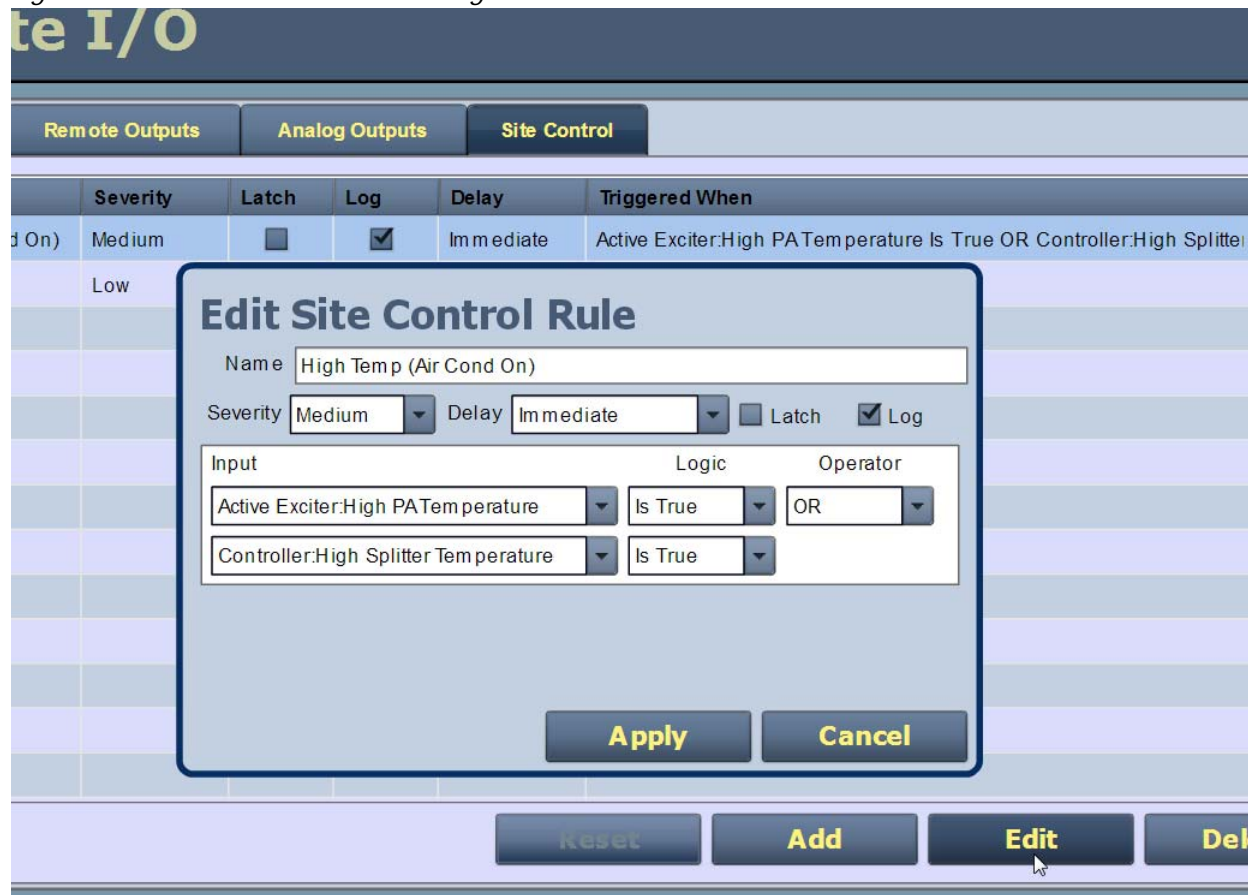

- ❖ In the Name section, enter a name for the rule. This will display on the Site Control page, as well the Logs page, when triggered.
- ❖ In the Severity section, use the drop-down menu to select Low, Medium or High. The selected severity level will display on the Status page and Events Log. See [Figure 3.2.11 on page 3.2.25](#) for a description of the severity levels for logged events.
- ❖ In the Delay section, use the drop-down menu to select the time delay after activation that the site control rule will take effect (i.e., be asserted). Select Immediate, 1 Sec, 2 Sec, 5 Sec, 10 Sec, 30 Sec or 60 Sec .
- ❖ Check the Latch check-box if you want the assertion of the rule to require a reset. If not, leave the box unchecked.
- ❖ Check the Log check-box if you want the assertion of the rule to display an alarm and log the event. If not, leave the box unchecked.

-
- ❖ In the Input section, use the drop-down menu to select the desired input (alarm, status or custom input) that will affect the rule. Note that a second input may also be selected in conjunction with a logic operation if the Operator section contains the AND, OR or XOR function.
 - ❖ In the Logic section, use the drop-down menu to select "Is True" or "Is False" to indicate the trigger for the assertion of the rule. Select "Is True" when you want the rule to assert when the associated input is active. Select "Is False" when you want the rule to assert when the associated input is inactive.
 - ❖ In the Operator section, use the drop-down menu to select a logic operation to combine two inputs. Select "blank" for no logic operation (i.e., for single input rules). For rules that use two inputs, select AND, OR or XOR, noting:
 - the AND function requires both inputs to be asserted (according to their selected Logic states) to activate the rule.
 - the OR function requires one or both inputs to be asserted (according to their selected Logic states) to activate the rule.
 - the XOR function requires one - and only one - input to be asserted (according to their selected Logic states) to activate the rule.
 - ❖ Press the Apply button to save the rule or the Cancel button to return to the Site Control page.

The Site Control page will display all rules, with the user-defined characteristics described above. Additionally, the current State of the rule will be displayed in a check-box on the right-hand side of the page. A checked box indicates the rule is currently active.

Applying a Site Control Rule to a Remote Input/Output

You can apply a site control rule as a Remote Output by selecting the desired rule from the Channel list in either the Remote Outputs tab. The Channel list should contain the names of all existing rules. See [Remote I/O Settings - Using the AUI, on page 3.2.156](#) for more details on configuring remote inputs and outputs.

Custom remote inputs can be created in the Remote Inputs tab. These inputs can be used within a site control rule.

Preset Scheduler

If the scheduler is enabled (see [Enabling the Scheduler on page 3.2.172](#)), you can program a yearly preset schedule for the transmitter. Use the Scheduler page (see [Figure 3.2.140](#)) to set the dates and times at which presets take effect. You can define up to 63 different schedule rules. To view the Scheduler page, select Scheduler from the Menu options.

Figure 3.2.140: Scheduler page

The screenshot displays the Nautel Scheduler interface. At the top, it shows the current date and time as 'Wed Mar 19 2014' and '14:15:49'. The transmitter status is '0 kW' with '88.00 MHz' and 'FM + HD' modulation. The active exciter is 'A'. Below this, the 'Scheduler' section features a monthly calendar for March 2014. The calendar has navigation buttons for previous/next month and previous/next day. The right side of the scheduler area contains 'Rules' and 'Daily Events' sections, each with a 'New', 'Edit', and 'Delete' button. At the bottom, there are status indicators for 'RF On' and 'RF Off', and a menu bar with buttons for 'Menu', 'Status', 'Logs', 'Local/Remote', 'Reset', and 'Log Out'.

The left-hand side of the Scheduler page displays a monthly calendar (e.g., March 2014). Use the << and >> buttons to navigate between months. Use the < and > buttons to navigate to the beginning and the end of the schedule.

The right-hand side of the Scheduler page contains a Rules section and a Daily Events section. Clicking on a specific date in the monthly calendar displays the rules and daily events, as applicable, for that day.

Figure 3.2.141: Rule Explorer window

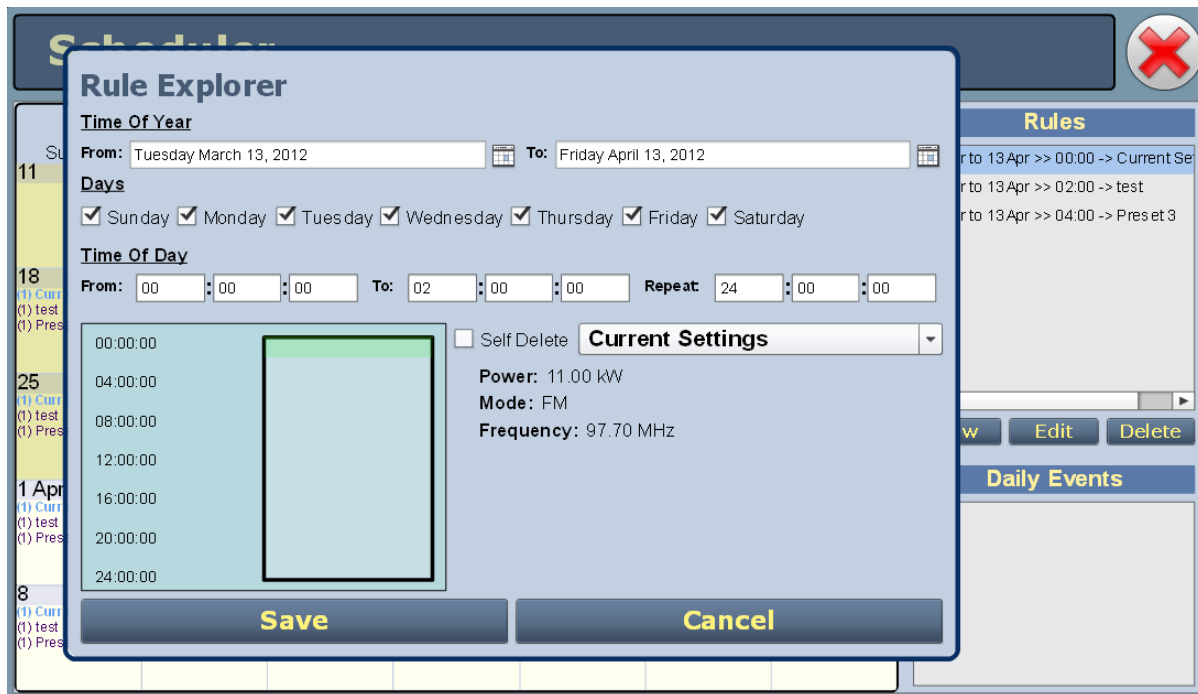

When you click in the Rules list, you have the option to edit or delete an existing rule, or to create a new rule. Click the New or Edit button to display the Rule Explorer window (see [Figure 3.2.141](#)). Click Delete to remove a rule from the list.

Use the Rule Explorer window as follows:

- ❖ In the Time of Year section, set the start (From:) and end (To:) dates for the rule. Start to end dates must be less than one year apart.
- ❖ In the Days section, select the days of the week on which the rule will apply.
- ❖ In the Time of Day section, set the start (From:) and end (To:) times (hours, minutes and seconds) for the rule. Use the Repeat: field to establish a repeating cycle for the rule (e.g., every 24 hours).
- ❖ Use the drop-down menu to select the preset (e.g., Current Settings) for the rule. The preset's power, mode and frequency are displayed below the preset.
- ❖ Unless you edit other rules first, you cannot select a date that occurs before the start of the previous rule or after the start of the following rule.
- ❖ Click the Save button to store the rule in the scheduler or the Cancel button to return to the Scheduler page.

Enabling the Scheduler

You can enable or disable the scheduler using the remote AUI (see [Enabling the Scheduler - AUI](#)) or using the local front panel display (see [Enabling the Scheduler - Front Panel](#)).

Enabling the Scheduler - AUI

Enable or disable the scheduler by clicking the Scheduler button in the Date & Time section (see [Figure 3.2.142](#)).

Figure 3.2.142: Enabling/disabling the scheduler - AUI

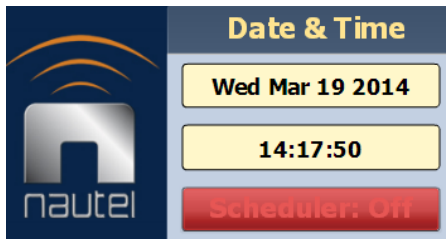

When Scheduler: ON appears, the transmitter will follow the Scheduler settings.

When Scheduler: OFF appears, the transmitter will stop following the schedule and the active preset will be the preset that was operating when the scheduler was disabled.

Enabling the Scheduler - Front Panel

To view the Scheduler enable/disable screen (see [Figure 3.2.143](#)) on the front panel display, select User Settings -> Scheduler from the Main Menu.

Figure 3.2.143: Enabling/disabling the scheduler - Front Panel

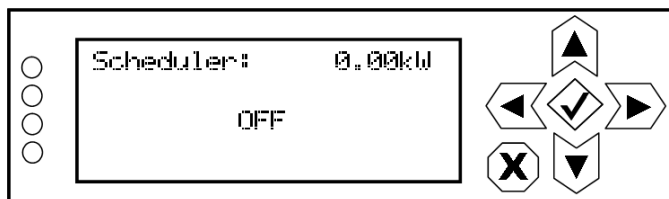

Use the up and down buttons to select ON (enable) or OFF (disable). The default setting is OFF. Press cancel (X) to return to the previous menu.

Audio Player

The built-in audio player (see [Figure 3.2.144](#)) can use a file playlist, Livewire or Shoutcast as an audio source. These sources must be configured before they can be used. This section describes how to configure audio player sources. To view the Audio Player page, select Audio Player from the Menu options. The Audio Player page has two selectable tabs:

- [Playlist](#) - see page 3.2.174
- [Streams](#) - see page 3.2.176

Figure 3.2.144: Audio Player page - Playlist tab shown

The screenshot shows the Nautel Audio Player interface. At the top, there are four main sections: Date & Time (Wed May 16 2012, 13:44:34, Scheduler: ON), Transmitter Configuration (0 kW, FM, 107.7 MHz, Reflected 0 W, Set Point 11.00 kW, Preset: Preset 3), and Exciter (Active Exciter A, FM Modulation 8.99%). Below this is the Playlist Manager section with tabs for Playlists and Streams. The Playlists tab is active, showing a table with one entry: 'Test Playlist'. To the right is the 'Available Files on USB' section with a list of MP3 files including 'Mumford and Sons - Dustbowl Dance.mp3', 'Kenny Chesney - Reality.mp3', 'Young The Giant - My Body.mp3', 'Mumford and Sons - Feel The Tide live at Shepherds Bush L...', 'Mumford and Sons - Sigh No More.mp3', 'Mumford and Sons - The Cave.mp3', 'Mumford and Sons - The Cave live at Shepherds Bush Londo', and 'Avicii - Levels.mp3'. At the bottom, there are buttons for 'Add', 'Delete', 'Insert JMP', 'Delete', 'Add File', and 'Refresh'. The bottom status bar shows 'RF On', 'RF Off', 'Logged in as: Nautel', 'Menu', 'Status', 'Logs', 'Local Remote', 'Reset', and 'Log Out'.

The playlist (or Shoutcast/Livewire stream) is typically used as an audio loss backup. For example, the user may operate with Preset 1 using one of the standard audio sources. Preset 1 can be configured to switch to another preset (e.g., Preset 2), which uses a playlist or stream, if Preset 1 loses its audio. See [Changing the OS Password, on page 3.4.4](#) for more information.

Playlist/stream presets can also be activated by the Scheduler (see [Preset Scheduler, on page 3.2.170](#)).

Playlist

The Playlist tab (see [Figure 3.2.144](#)) displays the audio files and sequence that currently make up the playlist. Only audio files that are supported (e.g., .wav or .mp3 files) will be played. For .mp3 files, using files with bit rates equal to or less than 96 kbps achieves best audio results. Also, you must activate a preset that has Playlist selected in the Main Audio -> Secondary Digital -> Secondary Source in the Presets menu. There are three sections in the Playlist tab - Playlists, Playlist Contents and Available Files on USB.

Figure 3.2.145: Managing Playlist files

The screenshot displays the Nautel transmitter control interface. At the top, there are three main sections: **Date & Time** (Wed May 16 2012, 13:44:34, Scheduler: On), **Transmitter Configuration** (0 kW, 107.7 MHz, 11.00 kW, Reflected 0 W, Set Point 11.00 kW, Preset: Preset 3), and **Exciter** (Active Exciter A, FM Modulation 8.99% / 100% / 160%).

The main area is the **Playlist Manager**, which has tabs for **Playlists**, **Streams**, and **Manage Files**. The **Manage Files** section is active and contains three tables:

Playlists		Playlist Contents		Available Files on USB
Type	Name	#	Path	Path
Playlist	Test Playlist			Mumford and Sons - Dustbowl Dance.mp3
				Kenny Chesney - Reality.mp3
				Young The Giant - My Body.mp3
				Mumford and Sons - Feel The Tide live at Shepherds Bush L
				Mumford and Sons - Sigh No More.mp3
				Mumford and Sons - The Cave.mp3
				Mumford and Sons - The Cave live at Shepherds Bush Londo
				Avicii - Levels.mp3

At the bottom of the interface, there are control buttons: **RF On**, **RF Off**, **Menu**, **Status**, **Logs**, **Local** (selected), **Remote**, **Reset**, and **Log Out**. The status bar also shows "Logged in as: Nautel".

NOTE: You should not change an active (playing) playlist nor should you attempt to delete or move a song that is currently playing. To make changes to the playlist, the audio player must be off (inactive) - or at least not being used as the active preset's source.

The Playlists section is used for adding (Add button) and deleting (Delete button) playlists.

The Playlist Contents section is used for inserting jumps (Insert JMP button) and deleting playlist contents (Delete button). The Insert JMP button allows the user to set up a playlist that can jump to an item in another playlist. You can drag files up and down the Playlist Contents list and you can drag files from the Available Files on USB list to the Playlist Contents list.

The Available Files on USB section is used for adding audio files to the playlist (Add Files button) or refreshing the playlist (Refresh button). Audio files must be stored on an external USB device plugged into the USB-A (A1J8B) or USB-B (A1J8C) connector on the rear of the controller; they are not stored in the transmitter. Only the audio files stored in the root directory of the most recently connected USB device appear on the playlist. The list will be empty if no USB device is connected. The USB drive must be formatted with a FAT32 file system. Click the Refresh button to force an update of the list of files on the mounted USB.

The length of the file name in the Audio Player USB Playlist must not exceed 255 characters and be no larger than 1 GB in size. The playlist should not exceed 700 files (based on an average file character length of 30, including the extension). If the average file character length is more than 30, the playlist file limit will be reduced.

The audio player supports only one USB device at a time. If multiple USB devices are connected, only the most recently connected USB is recognized as the active USB drive. If multiple USB devices are connected and one is removed, both devices are unmounted.

NOTE: MPEG Layer-3 audio coding technology licensed from Fraunhofer IIS and Thomson.

The Manage Files button displays a pop-up window that allows the user to Browse for files and Upload them to the USB or Delete them from the USB. You should not delete files that are part of more than one playlist.

Figure 3.2.146: Audio Player page - Streams tab



Streams

The NV20LT/NV15LT is capable of playing audio streams in either Shoutcast or Livewire format.

The audio player supports Shoutcast playlists and IP addresses for audio streams. For a Shoutcast playlist enter the URL for the station. For an audio stream, enter the URL for that stream.

Note:
 If your Icecast/Shoutcast stream drops out, the transmitter will continuously attempt to reconnect to the server, several times per second.

For Livewire, enter the channel that contains the desired audio.

Figure 3.2.147: Adding Audio Streams

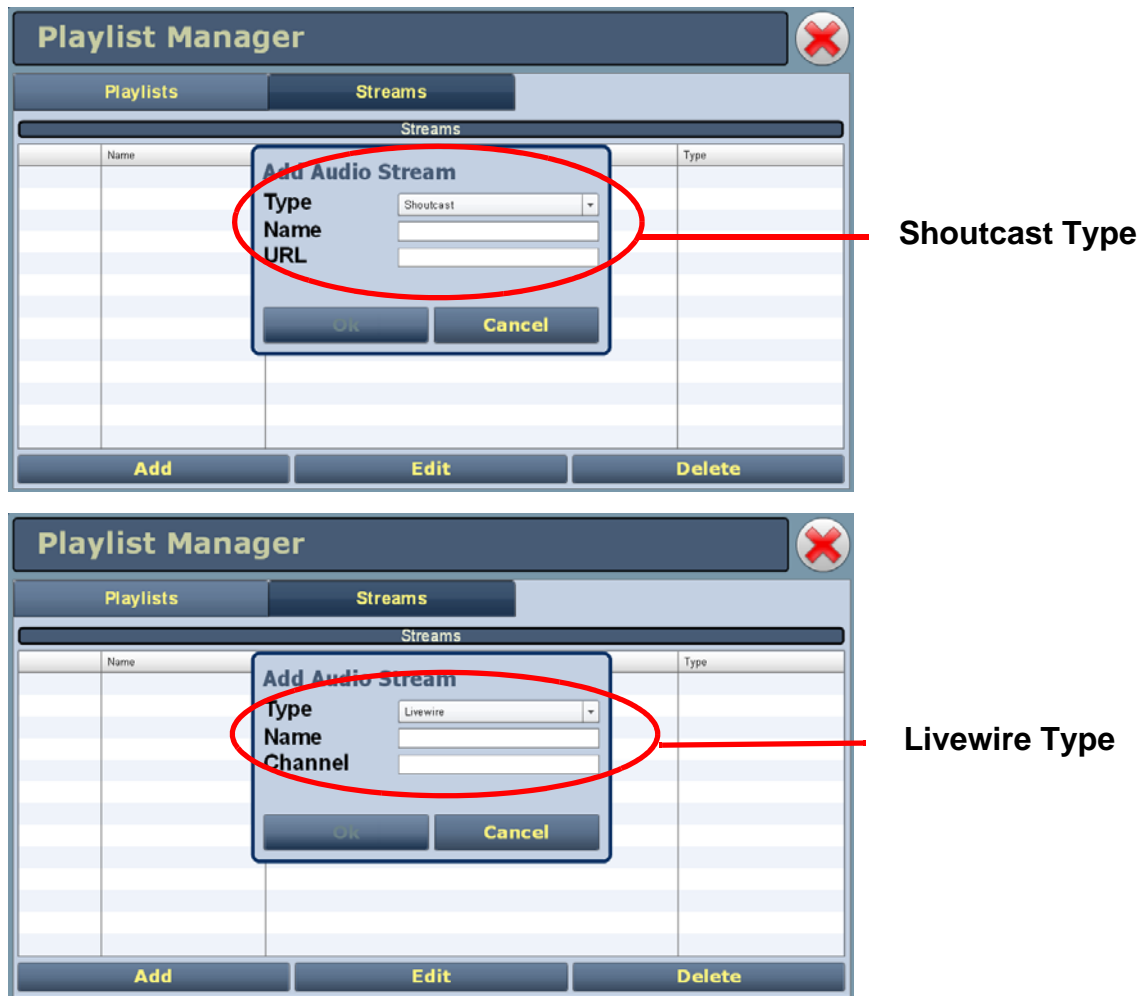

ADDING AN AUDIO STREAM

1. From the Streams tab (see [Figure 3.2.146 on page 3.2.176](#)), click the Add button.
2. Use the drop-down menu to select the desired Type of audio stream - Shoutcast or Livewire (see [Figure 3.2.147](#)).
3. Enter the appropriate information for the audio server (Name and URL for Shoutcast; Name and Channel for Livewire). Make sure the NV20LT/NV15LT can access the location.
4. Click OK to add the audio stream or click Cancel to discard changes.

EDITING OR DELETING AN AUDIO STREAM

1. From the Streams tab (see [Figure 3.2.146 on page 3.2.176](#)), select the desired audio stream from the list. Click the Edit button to modify the audio stream or the Delete button to remove the audio stream.
2. If you are editing an audio stream, enter the appropriate information for the audio server (Name and URL for Shoutcast; Name and Channel for Livewire). Make sure the NV20LT/NV15LT can access the location.
3. Click OK to either edit or delete the audio stream, or click Cancel to discard changes.

Changing Exciter Transfer Settings

If your transmitter contains dual exciters and is configured to operate with dual exciters, you can control the auto exciter transfer function using the remote AUI (see [Exciter Changeover Settings - Using the AUI](#)) or using the local front panel display (see [Exciter Changeover Settings - Using the Front Panel](#), on page 3.2.180).

Exciter Changeover Settings - Using the AUI

To view the Changeover page (see [Figure 3.2.148](#)), select Changeover from the Menu options or click on the Active Exciter area in the top, right-hand corner of the AUI. The Changeover page is only displayed on the Main Menu window and the Active Exciter click shortcut is only available when dual exciters are installed and configured.

NOTE: In order to edit any changeover settings, the transmitter must be configured for *Dual Exciter (A/B)* in the front panel UI's HW Config -> Installed Exc screen (see [Installed Exciter](#), on page 3.2.147).

Figure 3.2.148: Changeover page



- ❖ The Active Exciter is displayed (also displayed in the top, right corner of the AUI).
- ❖ For Main Exciter , select A or B.
- ❖ For Auto Changeover Enabled, select Yes if automatic changeover is desired or No if user selected/manual changeover is desired.

NOTE: If the standby exciter must be removed for service, Nautel recommends you set Auto Changeover Enabled to No while the standby exciter is unavailable for operation, instead of temporarily setting Standby Exciter to No.

- ❖ For Standby Exciter (appears when dual exciters are installed), select Yes if standby operation is available or desired or No if standby operation is not available or not desired. This is factory set and does not typically require adjustment.
- ❖ In the Delay field, enter the desired exciter transfer delay (in seconds; between 2 s and 120 s; default is 2 s) and press Apply.

Exciter Changeover Settings - Using the Front Panel

From the front panel UI, you can set the active exciter, main exciter, auto changeover status, changeover delay and exciter configuration. To view the Changeover screen, select Changeover from the Main Menu (see [Figure 3.2.149](#)).

NOTE: In order to edit any changeover settings, the transmitter must be configured for *Dual Exciter (A/B)* in the front panel UI's HW Config -> Installed Exc screen (see [Installed Exciter](#), on page 3.2.147).

Figure 3.2.149: Changeover Menu

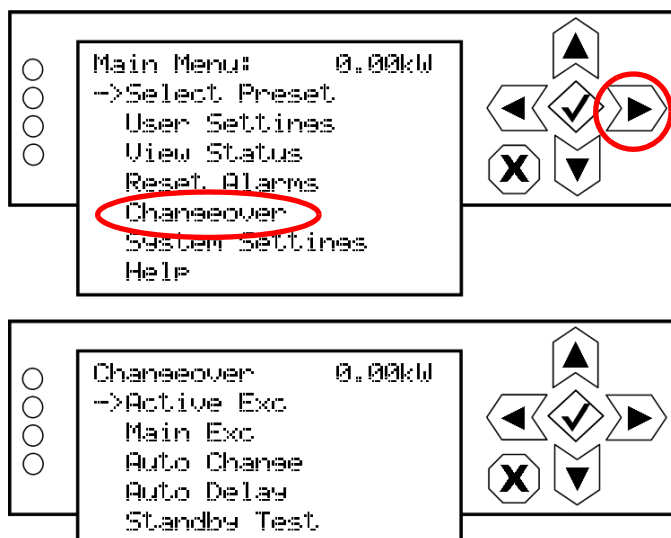

This menu has five sub-menu options. Use the up and down buttons to move the cursor to the desired display setting and then press the right button to enable editing of the setting. [Figure 3.2.150 on page 3.2.181](#) shows the editing screens for the Changeover menu. Within any of the editing screens, use the up and down buttons to edit a setting. Press the accept (checkmark) button to save the change. Press cancel (X) to discard changes and return to the previous menu.

WARNING! Before using the Standby Test function, make sure that the standby exciter's RF output is being applied to a suitably rated test load.

Figure 3.2.150: Changeover Editing Screens

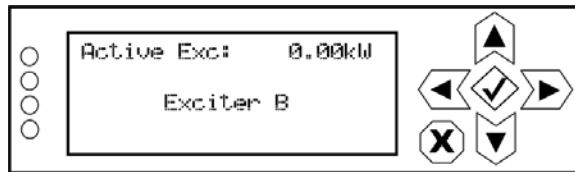

For display only. Indicates the active exciter - Ctrl/Exc A or Exciter B. Press the cancel (X) button to return to the previous menu.

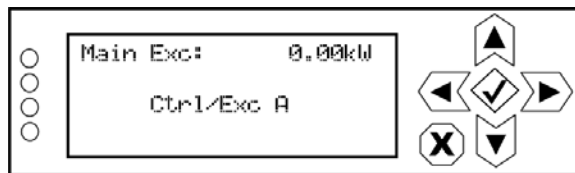

Allows user to set the transmitter's main exciter to Ctrl/Exc A or Exciter B. Typically, the main exciter is the exciter that operates until an automatic changeover occurs. The default setting is Ctrl/Exc A. Press the cancel (X) button to discard changes and return to the previous menu.

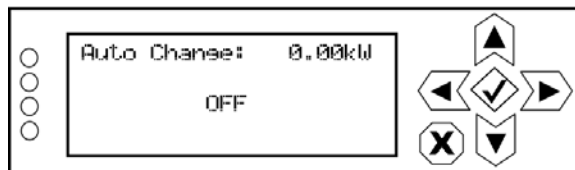

Configures the transmitter to enable (ON) or disable (OFF) automatic exciter changeover. Changeover to the standby exciter occurs if the current/active exciter experiences a fault that inhibits its operation. Press the cancel (X) button to discard changes and return to the previous menu.

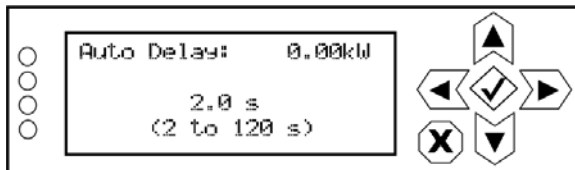

Sets the delay period after which an automatic changeover will occur to a value between 2 and 120 seconds (in 0.1 s increments). Default value is 2 s. Press the cancel (X) button to discard changes and return to the previous menu.

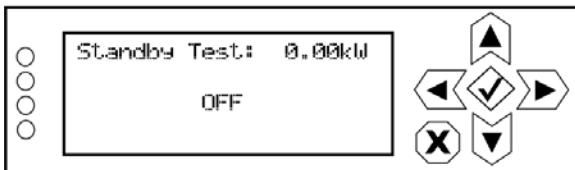

Configures the transmitter to enable (ON) or disable (OFF) the standby exciter's RF power stage to allow testing into a user provided dummy load. When enabled (ON), the exciter will operate at 100 W (ensure the test load is suitably rated). While enabled, auto exciter changeover is disabled (regardless of configuration status). Press the cancel (X) button to discard changes and return to the previous menu.

Enabling and Operating the Orban Audio Processor

This section describes how to configure, enable and operate the optional Orban audio processor after it is installed in your transmitter. You can interface with audio processor functionality locally, using the transmitter's front panel UI, or remotely, using the advanced user interface (AUI). The extent of the features available depends on which interface is used.

- [Configuring the Transmitter for the Orban Audio Processor - see page 3.2.183](#)
- [Enabling the Orban Audio Processor for Preset Selection - see page 3.2.184](#)
- [Selecting an Orban Audio Processor Preset - see page 3.2.187](#)

NOTE: Using the Orban Inside option requires the installation of an Orban audio processor card in your transmitter. If you had a pre-existing transmitter when you received your Orban Inside kit, verify that the Orban card has been installed in the transmitter according to the NVLT - Orban Inside Quick Guide (QG12001), provided with the Orban Inside kit. Refer to the Pre-installation and Installation Manuals for information on purchasing and installing this option.

NOTE: This section contains frequent reference to Orban's Optimod-FM 5500 Digital Audio Processor Operating Manual (see the link below). The equipment covered in the 5500 manual uses the same Orban audio processor as in your transmitter. The 5500 manual provides detailed information on the audio processor's functionality. If a discrepancy exists between the operational instructions in the Orban manual and this document, the latter shall prevail as this document is specific to operation with an NV20LT/NV15LT transmitter. View the Orban Optimod-FM 5500 Digital Audio Processor Operating Manual online at:

<ftp://ftp.orban.com/5500/Documentation/>

(the version number referenced in this link is controlled by a third party and is subject to change without notice)

Configuring the Transmitter for the Orban Audio Processor

NOTE: Audio processor configuration is only available using the front panel display.

Configure the NV20LT/NV15LT to recognize the presence of the Orban card using the front panel UI as follows:

1. With the transmitter turned on and in local mode of operation, navigate to the front panel UI's Main Menu -> System Settings -> HW Config menu. Scroll down through this menu and select Audio Processor (see [Figure 3.2.151](#)).
2. In the Audio Processor screen (see [Figure 3.2.151](#)), use the up and down buttons to toggle between None and Orban Inside (default factory setting is None). Select Orban Inside to enable the Orban audio processor for use (selecting None disables it). Press the accept (checkmark) button to save the change. Press cancel (X) to discard changes and return to the previous menu.
3. Reboot the transmitter by switching the ac power off and then on. This will ensure the transmitter properly detects the Orban Inside card upon recovery.

Figure 3.2.151: Configuring the Transmitter - Front Panel UI HW Config and Audio Processor screens

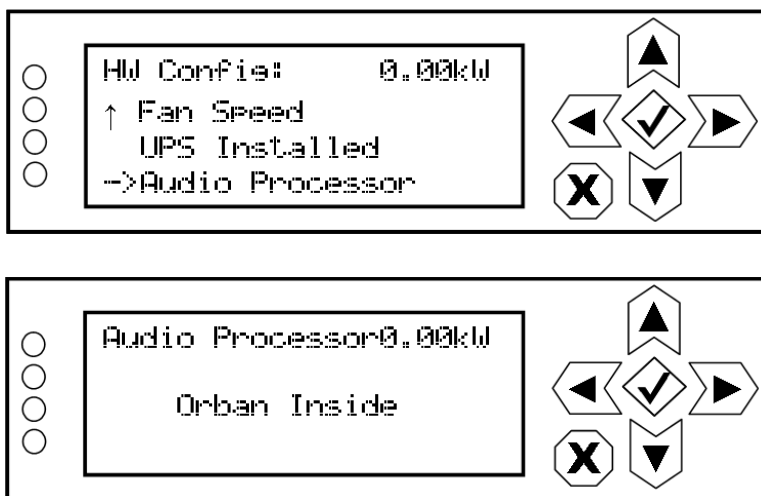

Enabling the Orban Audio Processor for Preset Selection

Enable the Orban audio processor to allow preset selection using either the front panel UI (see [Orban Enabling - Using the Front Panel](#)) or the remotely accessed AUI (see [Orban Enabling - Using the Remote AUI - see page 3.2.186](#)) as follows:

NOTE: Enabling the Orban audio processor locally will cause the remote AUI to display an enabled setting. The same occurs on the front panel UI when enabling remotely.

Orban Enabling - Using the Front Panel

1. With the transmitter turned on and in local mode of operation, navigate to the front panel UI's Main Menu -> User Settings menu. Select Edit Presets (see A in [Figure 3.2.152 on page 3.2.185](#)).
2. In the Edit Presets screen (see B in [Figure 3.2.152 on page 3.2.185](#)), select from the list the desired preset for use with the Orban audio processor or create a new preset.
3. Within the selected preset's screen (see C in [Figure 3.2.152 on page 3.2.185](#)), scroll down and select Main Audio.
4. Within the Main Audio screen (see D in [Figure 3.2.152 on page 3.2.185](#)), scroll down and select Audio Processor. This option appears only when the transmitter has been configured for Orban Inside.
5. Within the Audio Processor screen (see E in [Figure 3.2.152 on page 3.2.185](#)), select Enable. From the Enable screen, select ON to enable the audio processor (selecting OFF disables the audio processor)

NOTE: The Orban Inside card processes only the main audio; however it is possible for the composite SCA inputs to result in excessive modulation. The L/R limiter is automatically disabled when the Orban Inside card is selected; however the other limiters (hard limiter, AGC limiter, 2-slope limiter) remain active. Nautel recommends that you set the thresholds for these other limiters high enough to ensure the signal is unaffected. These other limiters remain as a last resort to prevent over-modulation.

Figure 3.2.152: Enabling the Orban Audio Processor - Front Panel UI

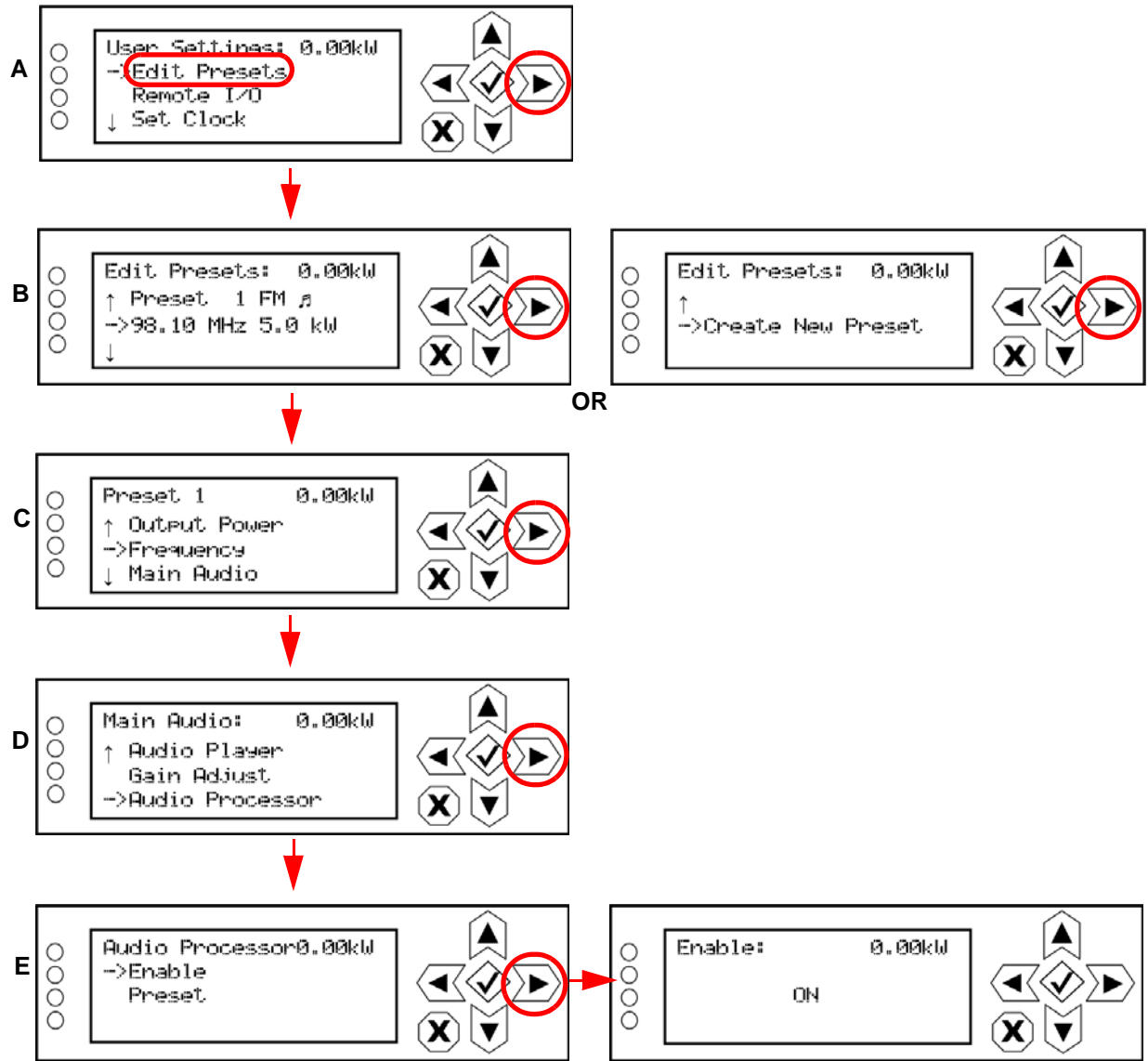

Orban Enabling - Using the Remote AUI

1. With the transmitter turned on, connected to a remote monitoring PC or laptop and in remote mode of operation, navigate to the AUI's Main Menu -> Presets page.
2. For the applicable preset, click on the Other Settings tab (see [Figure 3.2.153](#)).
3. In the Orban Processor drop-down list, select Enabled to enable the audio processor (selecting Disabled disables the audio processor). Click Save to store the change.

Figure 3.2.153: Enabling the Orban Audio Processor - Remote AUI

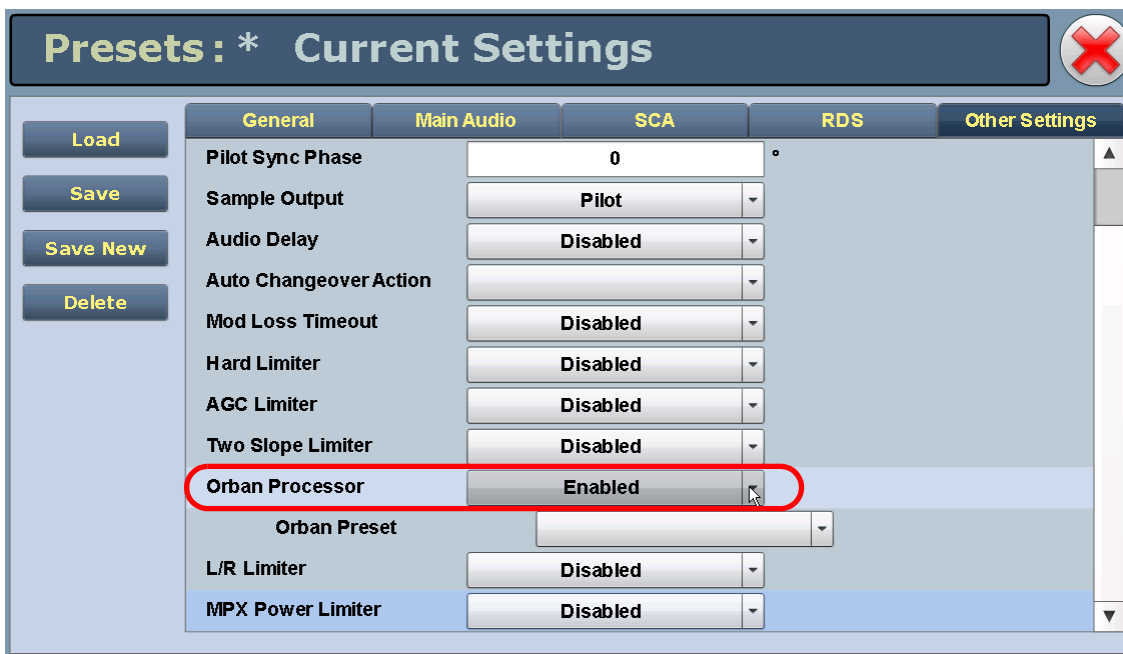

Selecting an Orban Audio Processor Preset

Select an Orban audio processor preset using either the front panel UI (see [Selecting an Orban Preset - Using the Front Panel](#)) or the remotely accessed AUI (see [Selecting an Orban Preset - Using the Remote AUI](#) - see page 3.2.188) as follows:

NOTE: Selecting an Orban preset locally will cause the remote AUI to also reflect the change. The same occurs on the front panel UI when remotely selecting a preset. To create a new Orban Audio Processor Preset, see [Managing an Orban Audio Processor Preset, on page 3.2.189](#).

Selecting an Orban Preset - Using the Front Panel

1. From the User Settings -> Edit Presets -> (Select desired preset to edit) -> Main Audio > Audio Processor menu (see [Figure 3.2.154](#)), select Preset.
2. Use the up and down arrows to scroll through the list of available Orban presets (e.g., ROCK-LOUD, etc). Select the desired preset and press the 'accept' (checkmark) button to activate. Refer to the Orban Optimod 5500 manual for detailed information on the factory programmed presets available.

Figure 3.2.154: Selecting an Orban Preset - Front Panel UI

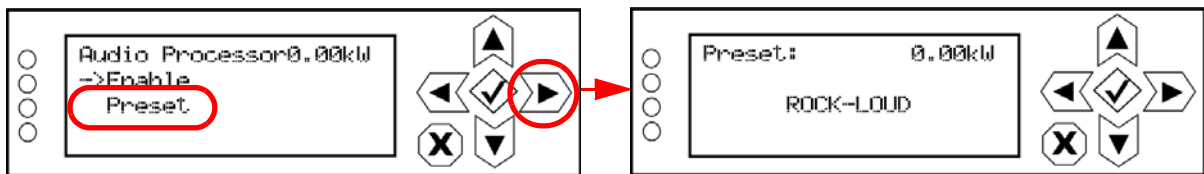

Selecting an Orban Preset - Using the Remote AUI

1. From the AUI's Main Menu -> Presets page, click on the Other Settings tab (see [Figure 3.2.155](#)).
2. From the Orban Preset drop-down list, select the desired Orban preset (e.g., ROCK-LOUD, etc). Refer to the Orban Optimod 5500 manual for detailed information on the factory programmed presets available. Click Save to store the change. To create a new Orban preset, see [Managing an Orban Audio Processor Preset, on page 3.2.189](#).

Figure 3.2.155: Selecting an Orban Preset - Remote AUI

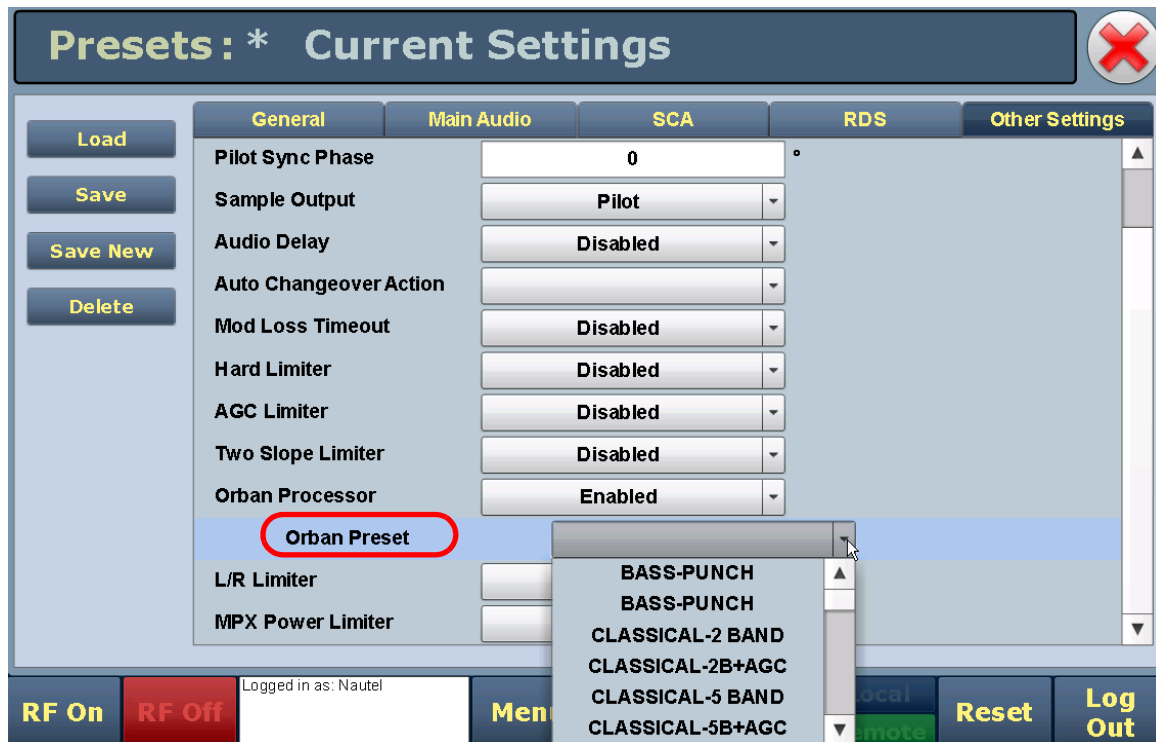

Managing an Orban Audio Processor Preset

Orban presets contain many audio processing settings, including stereo enhancement, AGC, EQ, final clipping and distortion. From the remote AUI (not available from the front panel UI), you can create Orban presets, manage their various settings and save the preset settings to a text file.

When the Orban Inside feature is enabled (see [Enabling the Orban Audio Processor for Preset Selection - see page 3.2.184](#)), an Audio Processor icon appears on the AUI's Main Menu window (see [Figure 3.2.156](#)). Click this icon to enter the Audio Processor menu (see [Figure 3.2.157 on page 3.2.190](#)).

WARNING! When you open the Audio Processor page while the transmitter is on and Orban is enabled, the active preset in the Orban audio processor is loaded by default. Loading another Orban preset causes that preset to become active, Make sure you understand the impact that a preset change will have on your broadcast.

NOTE: The Audio Processor page contains nine tabbed sections that allow managing of Orban presets. These tabbed pages (see [Figure 3.2.157 on page 3.2.190](#) and [Figure 3.2.159 on page 3.2.193](#) through [Figure 3.2.166 on page 3.2.196](#)) illustrate the many parameters associated with an Orban preset. Detailed descriptions are not included in this document. Refer to the Orban Optimod 5500 manual for more information on setting these parameters.

Figure 3.2.156: AUI Main Menu - with Audio Processor icon

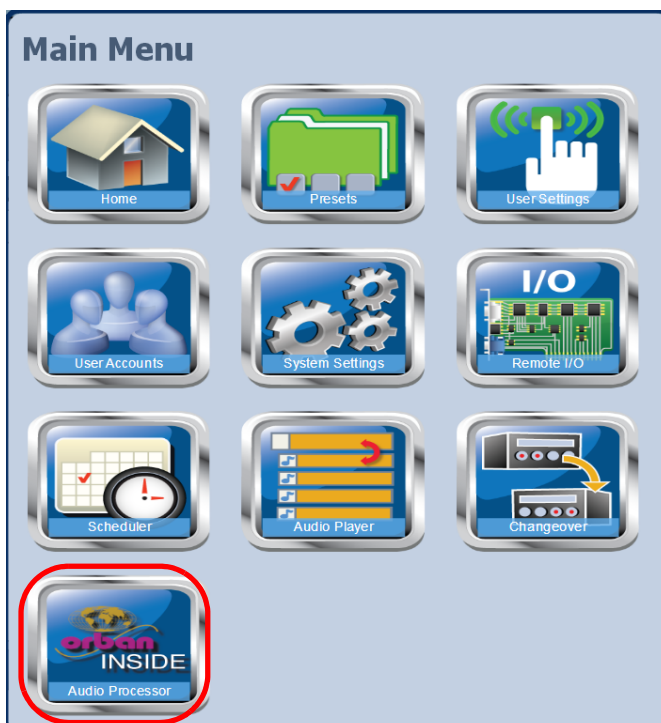

Figure 3.2.157: Audio Processor Menu - Less More tab shown

The screenshot displays the Nautel transmitter control interface. At the top, there are three main sections: **Date & Time** (Thu May 24 2012, 11:19:48, Scheduler: Off), **Transmitter Configuration** (0 kW, 107.7 MHz, 11.00 kW, Preset: *Preset 3), and **Exciter** (Active Exciter: A, FM Modulation: 9.02%). Below this is the **Audio Processor: *EXTREME** section. The **Less More** tab is selected, showing a slider bar with a green section between 1.0 and 10.0, and a current setting of 9.5. Red arrows point to the slider bar (labeled "Slider bar (green section)") and the adjustment buttons (labeled "Adjustment Buttons"). The bottom status bar includes **RF On**, **RF Off**, **Menu**, **Status**, **Logs**, **Local Remote**, **Reset**, and **Log Out**.

Loading and Saving Orban Presets

The left-hand side of the Audio Processor pages has four buttons (see below).



When you first enter the Audio Processor page, the current preset is displayed. If the current preset is not the preset you want to work with, press the Load button to call up a window containing a list of alternate presets. Presets that display an 'F' are factory presets that cannot be modified. Presets that display a 'U' are user presets that can be modified.

To activate any change in the Audio Processor page, press the Save button and then press the Save Preset window's Save As button [Save As and Delete buttons not available for factory (F) presets]. When creating a new preset, you can also enter a new name in the Save Preset window before pressing the Save As button. Press Cancel to discard changes and return to the Audio Processor page.

Pressing this button opens an Audio Processor meter window (see [Figure 3.2.158](#)) that displays various meters that indicate levels for inputs, AGC, gain reduction, multiplex (MPX) power and composite. Refer to the Operation section of the Orban Optimod 5500 manual for detailed information on these meters.

Pressing this button opens a window that allows downloading a text version of the preset to a folder on your PC or laptop.

Figure 3.2.158: Audio Processor meter window

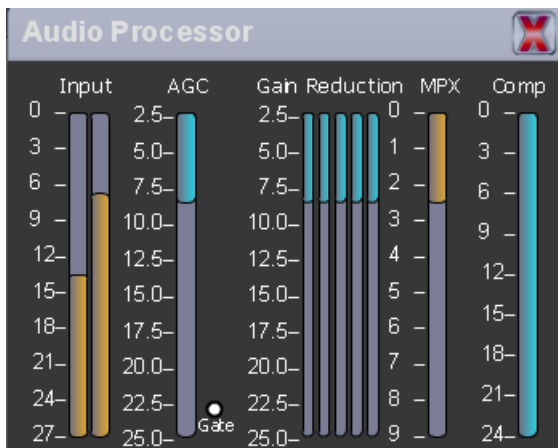

There are two types of Orban audio processor presets: factory presets and user presets. Factory presets, designated by an 'F' in the Load or Save screens, cannot be modified. When a factory preset control is changed, a new preset is automatically created. This preset's default name will be the same as the Orban preset with an asterisk (*) prefix (e.g., * EXTREME). Modified presets should be saved to a new name, otherwise they will be overwritten by any edits made to subsequent presets. A saved preset will display as a User preset, designated by a 'U' in the Load or Save screens. User presets can be modified.

NOTE: When editing saved "User Presets" it is the best practice to load a preset that is close to desired configuration and then tweak the settings for exact configuration.

Tab Sections

The following tabs (and referenced Figure numbers) are available on the Audio Processor page. Each provides specific control functions for the selected preset. Refer to the Orban Optimod 5500 manual for details on these settings.

- ❖ Less More - see [Figure 3.2.157 on page 3.2.190](#)
- ❖ Stereo Enhancer - see [Figure 3.2.159 on page 3.2.193](#)
- ❖ AGC - see [Figure 3.2.160 on page 3.2.193](#)
- ❖ EQ - see [Figure 3.2.161 on page 3.2.194](#)
- ❖ Final Clipping - see [Figure 3.2.162 on page 3.2.194](#)
- ❖ Multiband - see [Figure 3.2.163 on page 3.2.195](#)
- ❖ Compressors - see [Figure 3.2.164 on page 3.2.195](#)
- ❖ Bandmix - see [Figure 3.2.165 on page 3.2.196](#)
- ❖ Distortion - see [Figure 3.2.166 on page 3.2.196](#)

See [Figure 3.2.157 on page 3.2.190](#). Each control shows the current setting (in the middle of the control) and the available range of settings. You can make adjustments either by clicking on the << or >> buttons or by moving (click, hold and move mouse accordingly) the green slider bar, which indicates the setting graphically.

Figure 3.2.159: Audio Processor Menu - Stereo Enhancer tab



Figure 3.2.160: Audio Processor Menu - AGC tab



Figure 3.2.161: Audio Processor Menu - EQ tab



Figure 3.2.162: Audio Processor Menu - Final Clipping tab



Figure 3.2.163: Audio Processor Menu - Multiband tab



Figure 3.2.164: Audio Processor Menu - Compressors tab



Figure 3.2.165: Audio Processor Menu - Bandmix tab



Figure 3.2.166: Audio Processor Menu - Distortion tab



SECTION 3.3: ROUTINE MAINTENANCE

This section provides instructions for performing routine maintenance on the NV20LT/NV15LT transmitter. This section includes the following topics:

- [Scheduled Maintenance](#)
 - ❖ [Cleaning](#)
 - ❖ [Checking Hardware - see page 3.3.2](#)
 - ❖ [Battery Replacement - see page 3.3.2](#)
- [Replacing an Air Filter - see page 3.3.3](#)
- [Performing On-Air Checks - see page 3.3.5](#)
- [Replacing the Controller Assembly's Battery - see page 3.3.6](#)
- [Inspecting Lightning Protection Systems - see page 3.3.8](#)

Scheduled Maintenance

Scheduled maintenance consists of performing a visual inspection of the NV20LT/NV15LT at scheduled intervals. The recommended minimum time between scheduled maintenance visits is three months. Local operating and environmental conditions may dictate more frequent visits, while in remote sites less frequent visits may be acceptable. Experience and system reliability will determine the most practical schedule for a specific installation.

Cleaning

At a minimum, follow the cleaning procedures listed below.

NOTE: A site located in a dirty area using open-air cooling requires more extensive cleaning than a site located in a clean area using closed-air cooling.

1. Check the air filters, noting there is one in the front of the transmitter and one in the back of the transmitter. Remove the air filters, inspect them, then re-install the air filters if they are clean. If an air filter is dirty or damaged, replace it as soon as possible. See ["Replacing an Air Filter" on page 3.3.3](#).
2. Clean the NV20LT/NV15LT using a vacuum cleaner and a soft-bristle brush to remove loose dirt. Clean, damp rags should be used to remove dirt that cannot be removed with a vacuum cleaner. Never use compressed air to clean the NV20LT/NV15LT.

Checking Hardware

All hardware must be checked at least once a year. Thermal cycling from turning the NV20LT/NV15LT on and off will require more frequent checks.

- To prevent damaging the hardware, ensure that the proper sized tools are used. In most cases, hardware is metric.
- A mounting surface or terminal that has changed colour indicates a loose hardware connection.
- Check and, if necessary, retorque the ac input cables on terminal block TB1. See [Section 2.5, "Connecting Ac Power" on page 2.5.1](#) of the NV20LT/NV15LT Installation Manual to determine specific torque values.

Battery Replacement

The controller assembly contains a battery backup circuit that provides a memory of the transmitter time setting during ac power failure. See ["Replacing the Controller Assembly's Battery" on page 3.3.6](#).

Replacing an Air Filter

The transmitter contains four cotton air filters, two in the front panel and two in the upper, rear panel. If an air filter becomes dirty or damaged, replace it as follows:

Interval

As required.

Parts and tools

- Replacement air filter

Procedure

Take the following steps to replace an NV20LT/NV15LT air filter:

1. Order a new filter or filters, as necessary. You can order a standard sized filter from Nautel (Nautel Part # HR140) or from the manufacturer (standard size 15" x 24" x 2", American Air Filter PerfectPleat HC M8 MERV 8 or equivalent; actual size 14.5" x 23.5" x 1.75") or obtain one from any local supplier of HVAC supplies.
2. Unpack the new filter and inspect it for damage.
3. Remove the old or damaged filter (see [Figure 3.3.1 on page 3.3.4](#)) as follows:
 - ❖ For a front air filter, loosen the 13 quarter-turn fasteners on the front panel. Lift the front panel away from the transmitter, noting there are two slots in the bottom edge of the panel. On the back side of the panel, loosen the four quarter-turn fasteners securing the filter bracket to the panel. Lift out the filter bracket, noting it also has slots in its bottom edge. Remove (slide out) the air filter from the panel.
 - ❖ For a rear panel filter, loosen only the four quarter-turn fasteners securing the filter bracket to the panel (removal of the entire rear panel is not necessary). Remove the filter bracket. Remove (slide out) the air filter from the panel.
4. Insert the new air filter into the bracket, noting the air flow direction in [Figure 3.3.1 on page 3.3.4](#). Reinstall the filter bracket on its front or rear panel, as applicable. Tighten the quarter-turn fasteners (two in front or four in rear) to secure the filter bracket to the panel. For the front air filter, re-install the front panel and tighten its 13 quarter-turn fasteners to secure it to the transmitter.
5. Dispose of the dirty or damaged air filter.

Figure 3.3.1: Replacing Air Filters

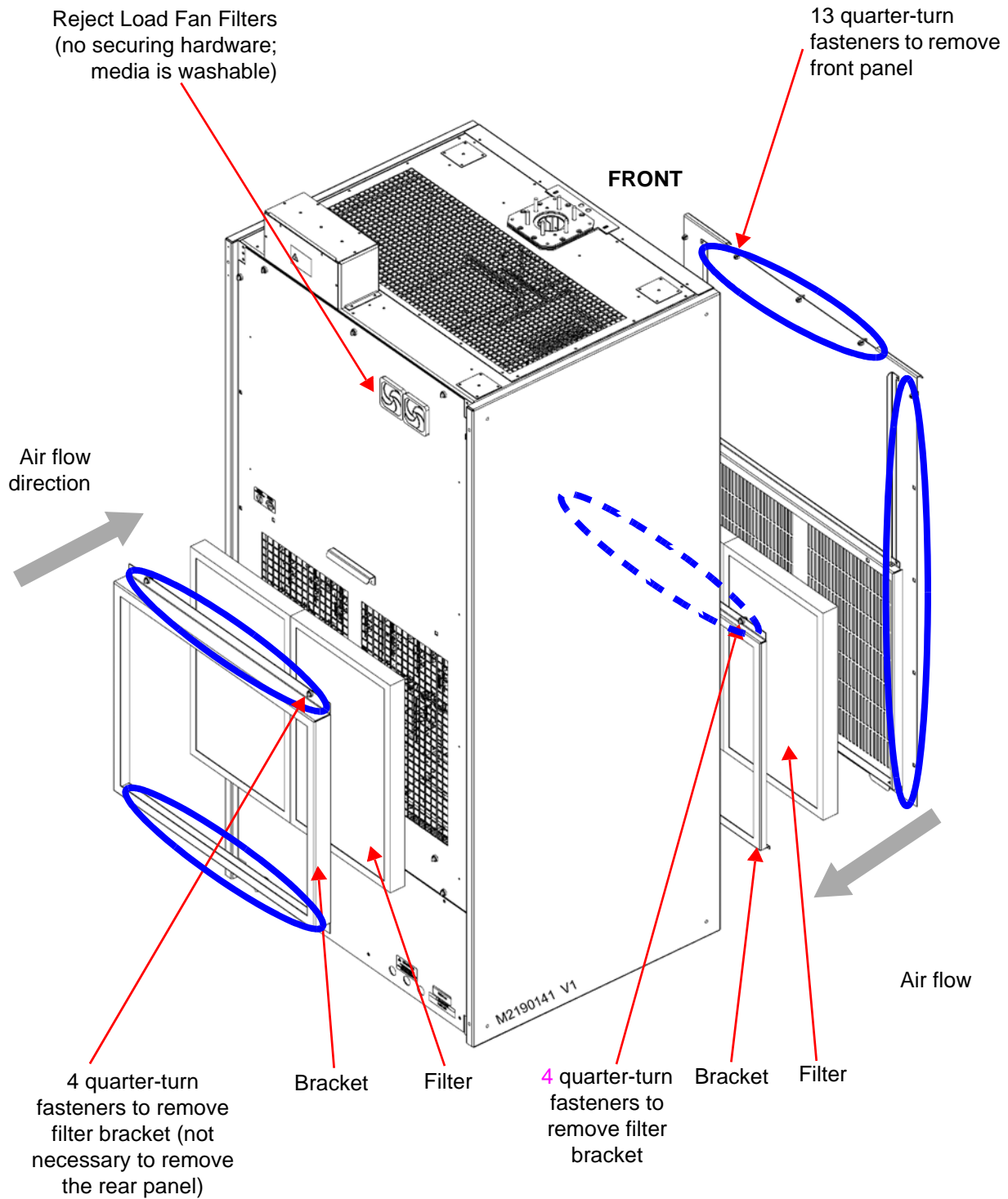

Performing On-Air Checks

You should check the on-air quality of the transmitter's signal periodically. This check can be done locally at the transmitter site, or remotely from another location in the transmitter's coverage area.

Interval

Every 12 months, or as required by law.

Parts and Tools

- High-quality receiver compatible with the modulation scheme used on the transmitter.

Procedure

1. Monitor the transmitter signal to identify any problems:
 - ❖ Use a high quality receiver to monitor audio quality.
 - ❖ Check the spectral output of the transmitter. If you have the optional exciter (NAE107B) installed, you can use the remote AUI's spectrum analyzer to accurately assess the transmitter's spectral output.
 - ❖ Take a portable receiver to different locations in your coverage areas to identify any problems with the antenna pattern or areas of localized interference.
2. Obtain the Critical Parameters sheet that was completed during factory testing and provided with the transmitter. Use the transmitter's AUI to compare current transmitter settings with those on the Critical Parameters sheet.

NOTE: Nautel completes the Critical Parameters sheet with the transmitter terminated into a precision 50 ohm load. Measurements made on site into a dummy load or station antenna may not yield the same readings. Slight variances are acceptable. The data is provided as a troubleshooting aid.

Replacing the Controller Assembly's Battery

Replace the battery on the controller assembly's exciter/control PWB (A4A1) once a year, or whenever the Controller - Low Battery alarm appears (on the remote AUI or via remote output). Chemical leakage from an old battery can cause damage. Nautel recommends you turn off (disable) the transmitter's ac power during this procedure.

Interval

Every 12 months.

Parts and Tools

Replacement battery: 3 V lithium coin cell, 20 mm (Panasonic # CR2032 or equivalent).

Procedure

Perform the following steps to replace the battery:

1. Ensure ac power to the transmitter is turned off or disabled.
2. Remove the upper, rear filter panel by loosening the 16 quarter-turn fasteners securing the panel to the transmitter.
3. Replace the battery in the 3V BATTERY holder on the rear of the controller assembly (see [Figure 3.3.2 on page 3.3.7](#)).
4. Re-install the upper, rear filter panel removed in [Step 2](#) and turn on (enable) ac power to the transmitter.
5. Check for any alarms on the front panel UI or the remote AUI (see ["Viewing Transmitter Status - AUI" on page 3.2.82](#)). Battery related alarms should clear.
6. Reset the system clock via the front panel UI or the remote AUI (see ["Setting the Clock" on page 3.2.120](#)).

NOTE: If the NTP server feature has been enabled, your clock setting will automatically reset within approximately five minutes. See ["Configuring NTP Servers" on page 3.2.123](#) for more information.

NOTE: If you are replacing the controller assembly's exciter/control PWB, remove the battery from the board's battery holder (XBT1) before installing it in the controller assembly.

Figure 3.3.2: Replacing Controller Battery

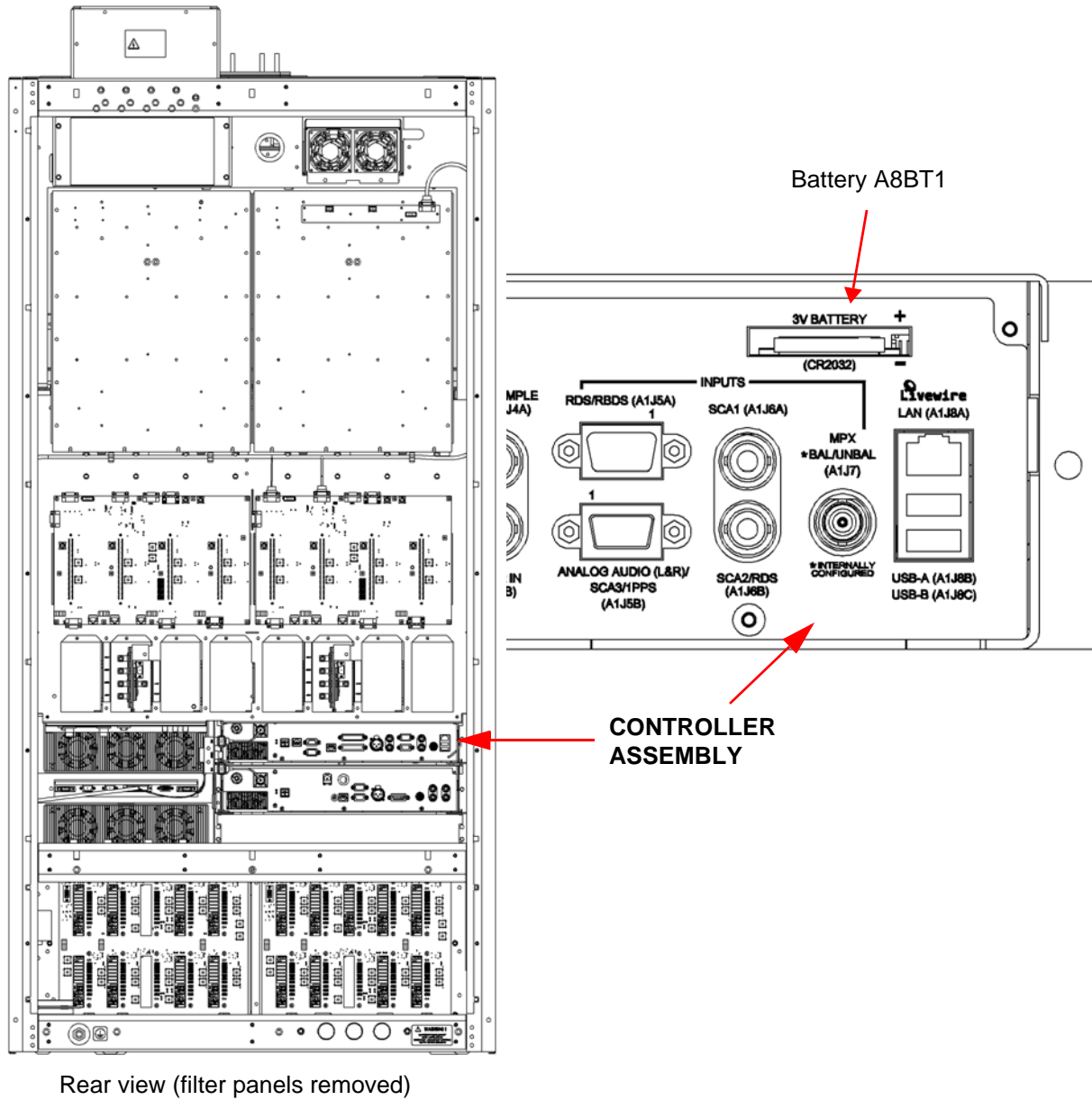

Inspecting Lightning Protection Systems

You should inspect the lightning protection systems that are connected to your NV20LT/NV15LT transmitter, ac power, RF feedline, antenna and tower periodically to ensure that your site, equipment and personnel are fully protected.

Interval

Every 6 months.

Parts and Tools

Depends on your site, but may include a digital multimeter, ladder, binoculars, and continuity tester.

Procedure

Perform the following steps to test the lightning protection systems:

1. Test the continuity between ground available at your lightning arrestor and ground available on various pieces of equipment connected to the transmitter. Ensure that there is no resistance (near 0 ohms, accounting for multimeter test lead resistance).
2. Physically inspect the lightning arrestor to ensure that all connections are tight. Also look for any sign of scoring or burning (indications of possible damage from earlier lightning strikes).
3. Using binoculars, visually inspect the hardware on the tower. Look for charred, broken or frayed connections and corrosion.

SECTION 3.4: NON-STANDARD MAINTENANCE

This section provides instructions for performing non-standard maintenance on the NV20LT/NV15LT transmitter. This section includes the following topics:

- [Upgrading Software](#)
- [Changing the OS Password on page 3.4.4](#)
- [Configuring a Mod Loss Backup Preset - see page 3.4.5](#)
- [Select the preset within the Save Preset window and click Save. This completes configuration of the Primary Audio preset. Return to the home AUI panel. - see page 3.4.9](#)

Upgrading Software

Periodically, enhancements or improvements to the operating system are identified and made available. Perform a software upgrade, as required, as follows:

NOTE: Nautel recommends you perform a software upgrade at the transmitter site.

NOTE: *For port-forwarded transmitters, uploading of the .tgz file must occur locally or on the transmitter side of the router.*

Parts and Tools

- Laptop (i.e., local computer for direct connection) or network computer with Windows and Internet Explorer Web browser
- CAT5 Ethernet cable
- Upgrade software (*.tgz file), provided via email or web download

Preliminary Checks

1. Determine the current software revision installed. Via the advanced user interface (AUI) screen, go to Menu/System Settings/Upgrade Software. Select the *.tgz file in the Select Upgrade File list (should highlight in blue) and click Details. Note the current software revision for Audio Player, AUI, Axia Livewire Module, Controller, Exciter A and B (if applicable), Orban Inside (if applicable), Rack, Server, SNMP Agent and Watchdog.
2. Contact Nautel for the most recent software revision and download *.tgz file to a laptop or network location.

3. Maximize the ARM's disk space by deleting the old .tgz files. Use the Manage Files button to display the Upload Files window, select the file(s) to delete, and click the Delete button

Transferring Upgrade File

The following steps assume either the laptop will be used to connect directly to the transmitter OR the transmitter and network computer are currently connected to the same network.

Transmitter IP Configuration

1. From the transmitter AUI, go to Menu/User Settings/Network Setup.
2. Record your current network settings (IP Address, Subnet Mask, Default Gateway).
3. If connecting to the transmitter directly with a laptop, you must set a static IP address. This can only be done via the front panel interface. From the front panel UI's Main Menu, go to User Settings/Network Settings and set the IP address as follows:
 - DHCP: OFF
 - IP Address: 10.10.10.2
 - Netmask: 255.255.255.0
4. Set the transmitter for Remote control.

Laptop IP Setup

The following steps assume the operating system is Windows XP. Adapt as required for computers with different operating systems.

1. On the laptop go to Start Menu/Control Panel/Network Connections/Local Area Network.
2. In the Local Area Network Status, open the General tab and choose Properties. Scroll down and highlight Internet Protocol (TCP/IP). Choose Properties.
3. In the Internet Protocol (TCP/IP) Properties window, select Use the following IP address.
4. Enter the following settings:
 - IP Address: 10.10.10.1
 - Subnet Mask: 255.255.255.0
 - Default Gateway: 192.168.1.2
5. In the Internet Protocol (TCP/IP) Properties window, select OK.
6. In the Local Area Connection Properties window, select OK.

7. In the Local Area Connection Status window, select Close.
8. Close the Network Connections window.

Transfer Software Upgrade File to Transmitter

1. If using a laptop, connect the laptop network interface card to the transmitter LAN (A1J8A) connector on the rear panel using a CAT5 Ethernet cable. Open Internet Explorer and search for 10.10.10.2. The transmitter login screen should appear.
2. If using a network computer, open Internet Explorer and search for the IP address recorded in [Step 2 of Transmitter IP Configuration, on page 3.4.2](#). The transmitter login screen should appear.
3. At the transmitter login screen enter:
 - User: "Nautel" or "****", where **** is the user assigned user name
 - Password: leave blank (default) or "****", where **** is the user assigned password
4. Navigate through the AUI to Menu/Software/Upload Files, select the upgrade files tab and press Browse. Locate the software update *.tgz file stored on the laptop or network computer, and press Upload to load the file into the transmitter upload file list. Allow this operation to complete.

Installing New Software

1. Set the transmitter to RF Off and for Remote control. If the transmitter is already in Remote control mode, turn off the transmitter using the AUI on the laptop. Perform the following steps remotely using the AUI on the laptop.
2. Go to the AUI Menu/System Settings/Upgrade Software screen and select the update *.tgz file from the Select Upgrade File list (should highlight in blue) and press Start Upgrade.

CAUTION! Do not leave this page until the flash process is complete.

3. After a successful load (status is 100% complete and a message indicates a successful load), cycle the ac power (turn off, then on) on the NV20LT/NV15LT.
4. This completes the software upgrade. Restore the former network settings on the transmitter and laptop as required (see [Step 2 of Transmitter IP Configuration, on page 3.4.2](#)).
5. Login and repeat [Step 1 of Preliminary Checks, on page 3.4.1](#) to determine if the current version is the same as the upgrade version - this confirms the upgrade was successful.
6. If the upgrade was not successful, repeat [Step 1](#) through [Step 5](#). If still unsuccessful, contact Nautel.

Changing the OS Password

The OS (operating system) password is a unique, factory set password that is recorded in the OS Password document provided with the transmitter. It should not be necessary to change this password unless there has been a network security breach and access to the transmitter is compromised.

To change the OS Password, you will need to remotely connect to a Linux computer using SSH. PuTTY is a common utility for Windows users (available at <ftp://www3.nautel.com/Utilities/putty/putty.exe>; if unable to open this link, use a search engine to find new URL), while Linux users can use 'ssh' from the command line. Change the OS password as follows:

1. Connect to the transmitter IP address using your selected SSH client.
2. Login with username root and the OS Password provided with your transmitter on the OS Password document.
3. At the prompt, type the command `passwd`. This is the Linux command to change your password.
4. Enter and confirm your new password.
5. Record your new password on the OS Password document provided with the transmitter. If you would like Nautel to track your password for support purposes, please email support@nautel.com with your new information.

Close the console window.

NOTE: *If a replacement CF (compact flash) card is purchased through Nautel, the OS Password will be programmed with what we have on file for your transmitter. If no password is on file, a new unique password will be programmed and sent along with the CF card.*

Configuring a Mod Loss Backup Preset

The NV20LT/NV15LT contains an audio level detection circuit that can be used, when enabled, to allow switching to a secondary (backup) audio input source upon the loss of the primary source. Configure the desired transmitter preset to perform this function as follows (refer also to Section 2 of this manual for operating instructions of the front panel (UI) and remote (AUI) interfaces:

NOTE: You must configure a minimum of two presets to allow this feature to operate. One preset will act as the primary, or normal operating preset. The second preset will act as the secondary, or backup audio preset. Configure the backup audio preset first.

Configuring the Backup Audio Preset

1. Consider the following limitations when selecting a backup preset:
 - ❖ If the exciter has an Orban Inside installed and enabled, then only one AES source can be used for either the primary or backup source.
 - ❖ If MPX over AES is used for either the primary or backup, the other source cannot be AES (either primary or secondary).
 - ❖ If MPX over AES is used for either the primary or backup, the other source can only be composite
 - ❖ If MPX SCAs are enabled, then audio backup cannot be used with MPX as either the main or backup source.
 - ❖ If running AES as either primary or backup source, then the other source cannot be the audio player
2. From the transmitter AUI, go to Menu/Presets/Load. The Load Preset window in [Figure 3.4.1](#) shall display.
3. Select a suitable preset to use as a template to create a new backup audio preset. Click Load.

Figure 3.4.1: Load the Backup Preset Template

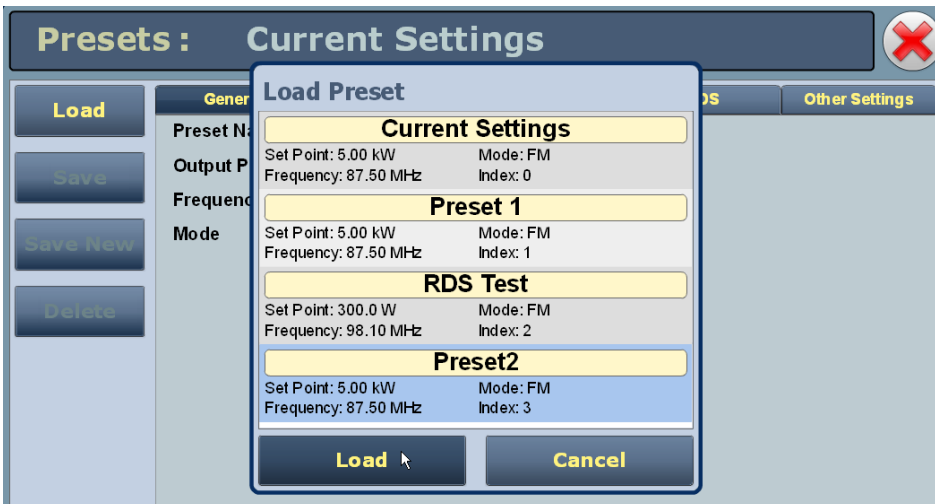

Figure 3.4.2: Backup Preset Main Audio Screen



- The setup page for the selected preset should now appear. Click the Main Audio tab (see [Figure 3.4.2](#)).
- Click the Audio Source field's drop-down arrow to view the available audio sources. Select the desired backup audio source.
- Configure the other fields associated with your Audio Source selection.

7. To save your changes without affecting the original template preset's settings, create a new preset as follows (see also [Figure 3.4.3 on page 3.4.7](#)):
 - ❖ Click the Save button on the left side of the AUI display. The Save Preset window will appear.
 - ❖ The template preset's name appears just below the list of presets. Click in the name field and enter the new name of the backup preset being created (e.g., Back Up Audio Preset).
 - ❖ Do not click Save. It will overwrite or rename the original template preset.
 - ❖ After naming the new backup audio preset, click the Save As button.
 - ❖ This will save the preset as a new preset and not effect the original template preset. This completes configuration of the Backup Audio preset. Return to the home AUI panel.

Figure 3.4.3: Saving the Backup Preset



Configuring the Primary Audio Preset

1. Go to Menu/Presets/Load. The Load Preset window in [Figure 3.4.1](#) shall display.
2. Select your primary or normal preset to allow editing of its audio loss parameters. Click Load.
3. The setup page for the selected preset should appear. Click the Other Settings tab (see [Figure 3.4.4 on page 3.4.8](#)).
4. Open the Mod Loss Timeout field's drop-down menu. Select Yes. This will display five sub-fields - Action, Mod Loss Preset, Timeout Minutes, Timeout Seconds and Threshold.
 - ❖ Open the Action field's drop-down menu. Select Change Preset.
 - ❖ Open the Mod Loss Preset field's drop-down menu. Select the newly created backup audio preset.
 - ❖ Enter in the Timeout Minutes and/or Timeout Seconds fields the desired delay between the loss of audio and the action to change to the backup preset.
 - ❖ Enter in the Threshold field the desired percentage level of audio at which the timeout period begins. Typically, this is set to 10%.

Figure 3.4.4: Normal Preset - Other Settings screen

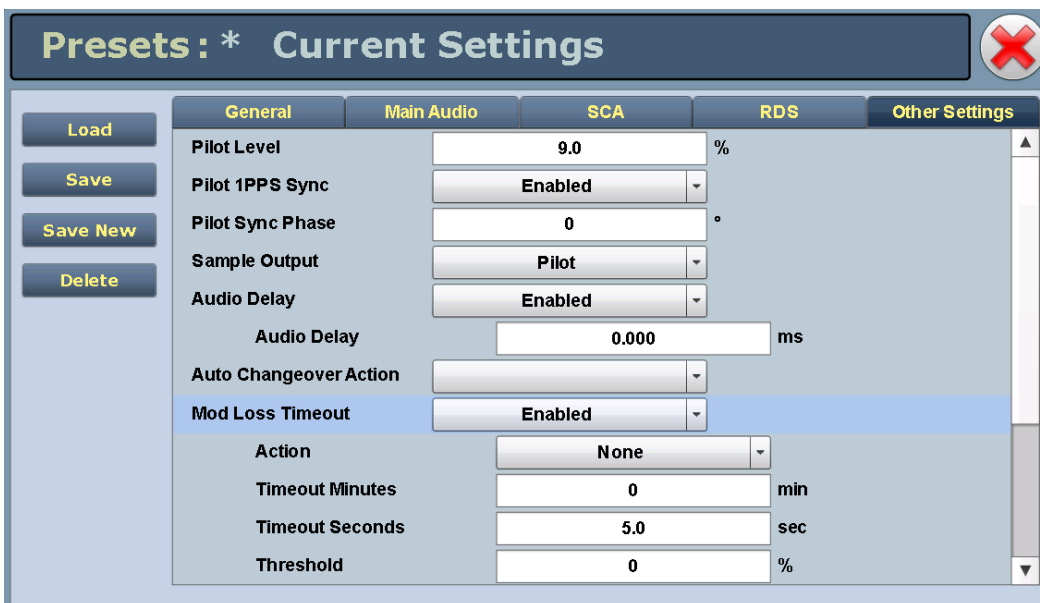

NOTE: SCA, RDS and Pilot modulation levels are additive and contribute the audio level. If their combined levels exceed the audio loss threshold level, a preset change will not occur. Stations with audio content containing extended nulls or silent periods (e.g., classical music) should consider reducing the audio loss threshold or increasing the timeout period.

5. After configuring the modulation loss parameters, click the Save button. The Save Preset window will appear.
6. Select the preset within the Save Preset window and click Save. This completes configuration of the Primary Audio preset. Return to the home AUI panel.

Reducing Power Below Minimum Set-Point (Safe Tower Maintenance)

To safely perform antenna tower maintenance within the United States (as per FCC RFR) and Canada (as per Health Canada’s Safety Code 6), the NV20LT/NV15LT’s RF output power must be reduced below the normal minimum set-point. To achieve this, RF power modules are inhibited (disabled), using their front panel ENABLE/DISABLE switch until the output power is below 600 W.

Table 3.4.1: Minimum power set-points for NV20LT/NV15LT operating modes

Operating Mode	Minimum Power Set-Point (W)
FM (analog)	600

1. In the current preset, note the operating mode and the current RF output power set-point, then set the output power for the minimum power set-point (see [Table 3.4.1](#)).
2. Open the transmitter’s front doors.
3. While monitoring the RF output power, set the ENABLE/DISABLE switch of RF power module 1 to the DISABLE (down) position. Continue disabling odd-number RF power modules (3, 5, etc.), and if necessary, even-number RF power modules (2, 4, etc.) until the RF output is less than 600 W. This inhibits the RF outputs of these modules and reduces the total power output (TPO) of the transmitter below 600 W.

NOTE: *You can reduce power further below 600 W if desired, by disabling more RF power modules.*

4. The transmitter output power is now below 600 W. Perform the remaining required site or antenna tower tasks - as per site operating procedures - to make tower make tower maintenance safe for personnel.

When maintenance is complete, restore RF output power to the previous level by setting the ENABLE/DISABLE switch of the disabled RF power modules to the ENABLE (up) position and then resetting the output power to the original level in [Step 1](#). Close the transmitter’s front doors.

SECTION 3.5: LIST OF TERMS

This section defines some of the terms that are used in Nautel documentation.

AES/EBU. Audio Engineering Society/European Broadcasting Union (AES/EBU) is the name of a digital audio transfer standard. The AES/EBU digital interface is usually implemented using 3-pin XLR connectors (the same type connector used in professional micros). One cable carries both left-channel and right-channel audio data to the receiving device.

AUI. The Advanced User Interface is the advanced remote control/monitoring feature that allows for extensive remote control and monitoring of the transmitter.

CUTBACK. A reduction in RF output power, caused by the occurrence of multiple shutbacks within a pre-defined period.

DHCP. Dynamic Host Carrier Protocol.

DSP. Digital Signal Processing.

EEPROM. Electrically Erasable Programmable Read-Only Memory.

FOLDBACK. A reduction in RF output power, caused by adverse load conditions (high VSWR). No shutbacks or cutbacks have occurred.

LED. Light Emitting Diode (also referred to as lamp).

LVPS. Low Voltage Power Supply. A module or modules used in the ac-dc power stage that generates the low level dc supply voltage for the transmitter.

PRESET. A setting that controls power level, frequency and audio parameters. The NV20LT/NV15LT allows you to pre-program multiple presets.

PWB. Printed Wiring Board.

SHUTBACK. A complete, but temporary loss of RF output power, caused by any one of a variety of faults, including high VSWR, high reject load power, RF drive failure, or an open external interlock.

SHUTDOWN. A complete and permanent loss of RF output power. Typically follows repeated cutback, foldback or shutback events.

SURGE PROTECTION PANEL. An electrical panel that protects equipment from electrical surges in the ac power supply, antenna or site ground caused by lightning strikes.

UI. The User Interface is the front panel LCD screen that allows for extensive local control and monitoring of the transmitter.

VSWR. Voltage standing wave ratio. This is an expression of the ratio of reverse voltage to forward voltage on the feedline and antenna system. An ideal VSWR of 1:1 provides maximum transmitter-antenna efficiency.

NV20LT/NV15LT OPERATIONS & MAINTENANCE MANUAL

Document: NHB-NV15LT-NV20LT-OPS

Issue: 2018-02-26

Nautel Limited

10089 Peggy's Cove Road
Hackett's Cove, NS Canada B3Z 3J4

Toll Free: +1.877.6NAUTEL (662.8835)
(Canada & USA only) or

Phone: +1.902.823.3900 or

Fax: +1.902.823.3183

Nautel Inc.

201 Target Industrial Circle
Bangor, Maine USA 04401

Phone: +1.207.947.8200

Fax: +1.207.947.3693

Customer Service (24-hour support)

+1.877.628.8353 (Canada & USA only)

+1.902.823.5100 (International)

Email: support@nautel.com

Web: www.nautel.com

© Copyright 2018 NAUTEL. All rights reserved.

