



3: OPERATIONS & MAINTENANCE MANUAL

GV5/GV3.5 TRANSMITTER

Document ID:	NHB-GV3.5-GV5-OPS
Version:	0.2
Issue Date:	2014-07-23
Status:	Preliminary



Contact Information

Nautel Limited

10089 Peggy's Cove Road
Hackett's Cove, NS Canada B3Z 3J4

Toll Free: +1.877.6NAUTEL (662.8835)
(Canada & USA only) or

Phone: +1.902.823.3900 or

Fax: +1.902.823.3183

Nautel Inc.

201 Target Industrial Circle
Bangor, Maine USA 04401

Phone: +1.207.947.8200

Fax: +1.207.947.3693

Customer Service (24-hour support)

+1.877.628.8353 (Canada & USA only)

+1.902.823.5100 (International)

Email: support@nautel.com

Web: www.nautel.com

The comparisons and other information provided in this document have been prepared in good faith based on publicly available information. For verification of materials, the reader is encouraged to consult the respective manufacturer's most recent publication on the official website or through contact with Customer Service.

© Copyright 2013 NAUTEL. All rights reserved.

CONTENTS

Contact Information	3.iii
<hr/>	
RELEASE CONTROL RECORD	3.vii
<hr/>	
DESCRIPTION	3.1.1
Ac-Dc Power Stage	3.1.1
Control/Monitor Stage	3.1.3
RF Drive Stage	3.1.4
RF Power Stage	3.1.5
<hr/>	
OPERATING THE TRANSMITTER	3.2.1
User Interface Options	3.2.4
Advanced User Interface (AUI)	3.2.9
Controller Front Panel	3.2.17
Home Page	3.2.24
Viewing Transmitter Log	3.2.27
Viewing Tool Menu Panels	3.2.37
Viewing Real-Time Meters	3.2.53
Presets - Editing Operational Settings	3.2.60
Resetting Alarms	3.2.98
Viewing Transmitter Status - using the AUI	3.2.99
System Settings	3.2.101
User Accounts	3.2.130
Changing Exciter Transfer Settings	3.2.134
User Settings - AUI	3.2.137
User Settings - Controller UI	3.2.166
Configuring Remote Inputs and Outputs	3.2.173
Preset Scheduler	3.2.187
Audio Player	3.2.190

Enabling and Operating the Orban Audio Processor	3.2.196
--	---------

ROUTINE MAINTENANCE	3.3.1
Scheduled Maintenance	3.3.1
Replacing an Air Filter	3.3.3
Performing On-Air Checks	3.3.6
Replacing the Controller Module's Battery	3.3.7
Inspecting Lightning Protection Systems	3.3.9

NON-STANDARD MAINTENANCE	3.4.1
Upgrading Software	3.4.1
Configuring a Mod Loss Backup Preset	3.4.4

LIST OF TERMS	3.5.1
----------------------	--------------

RELEASE CONTROL RECORD

ISSUE	DATE	REASON
0.1	2013-04-04	Preliminary Release of GV5/GV3.5 (NARF71A/02)
0.2	2014-07-23	Updated Section 2: Operating the Transmitter for software version 4.1; added information for Xmtr PA Bias routine

SECTION 3.1: DESCRIPTION

This section provides a high-level description of the transmitter's key sections. The transmitter circuitry is subdivided into four basic stages:

- [Ac-Dc Power Stage](#)
- [Control/Monitor Stage - see page 3.1.3](#)
- [RF Drive Stage - see page 3.1.4](#)
- [RF Power Stage - see page 3.1.5](#)

Refer to the functional block diagrams: [Figure 3.1.1 on page 3.1.9](#) (GV5/GV3.5 transmitter) and [Figure 3.1.2 on page 3.1.10](#) (audio path).

GV5/GV3.5 Electrical Schematics

Some descriptions in this section refer to electrical schematics (SD-#s) . These are located in Section 4 of the GV5/GV3.5 Troubleshooting Manual.

Ac-Dc Power Stage

See electrical schematic Figure SD-1. The ac-dc power stage provides power to operate the low voltage power supplies, which generate the 40 to 48 V dc voltage that is converted to the low level dc voltages (± 15 V and +5 V) used throughout the transmitter. This voltage is also conditioned to operate cooling fans in the RF power module and reject load assemblies. The ac-dc power stage also converts the ac power source to a positive dc voltage (PA volts) for the transmitter's RF power amplifiers and exciter(s). The transmitter accepts a wide range of ac input voltage options:

- ❖ 3-phase, 180 - 264 V ac (208 V ac nominal)
- ❖ 3-phase, 312 - 457 V ac (380 V ac nominal)
- ❖ 1-phase, 180 - 264 V ac (240 V ac nominal)

The ac-dc power stage comprises ac input terminal block TB1, power supply interface PWB (A1), low voltage power supply (LVPS) modules A (U2), B (U3), and power supply modules (U4 through U7), two for each of the two RF power modules. There are three amber LED pilot lamps (DS1 through DS3), located in the bottom, rear of the cabinet, that indicate the presence of each ac phase.

Power Supply Interface PWB

See electrical schematic Figure SD-1. The power supply (PS) interface PWB (A1):

- ❖ interfaces between the ac input on terminal block TB1 and the LVPS and power supply modules.
- ❖ distributes LVPS voltage to the RF drive (exciter) stage and the control/monitor stage.
- ❖ distributes PA voltage to the RF power stage and the control/monitor stage.
- ❖ controls, with the controller module, the LVPS output voltage.
- ❖ provides RS485 serial communication between the module control/interface PWB and the RF power module power supplies.
- ❖ allows configuration of the LVPS modules if the UPS option is installed.
- ❖ provides status and alarm outputs from the LVPS and power supply modules, consisting of Module Present, Power Fail Warning, Rectifier Fault and Overtemp Warning (provided to the module control/interface PWB over a serial bus).

LVPS Modules

See electrical schematic Figure SD-1. LVPS modules A (U2) and B (U3) convert the ac input voltage to the regulated output (40 - 48 V dc, nominally 40 V) that is applied to, and controlled by, the controller module via the module control/interface PWB. +5 V, +15 V and -15 V regulated outputs are developed from the LVPS output voltage (40 - 48 V dc) on the module control/interface PWB.

Power Supply Modules

See electrical schematic Figure SD-1. Power supply modules U4 through U7 convert the ac input voltage to a regulated dc supply (PA volts) for both RF power modules. Each switching power supply module is rated for a nominal 2725 W and provides an output voltage between 18 V and 53 V (typically 40 V). The modules regulate the output voltage based on a serial control input from the controller module (A4), applied via the module control/interface PWB. Each module has a built-in cooling fan, senses excessive temperature conditions and applies an Overtemp Warning signal (for indication purposes only) to the module control/interface PWB. The module also senses out-of-regulation on the ac input and dc output, and applies a Power Fail Warning signal to the module control/interface PWB. Both conditions cause the power supply to shut itself down, thus reducing the transmitter's RF output. All power supply module signals are applied to the controller for system level monitoring.

Control/Monitor Stage

See electrical schematic Figure SD-2. The control/monitor stage performs many critical functions for the transmitter. It:

- ❖ contains monitoring and protection circuits to prevent transmitter damage under adverse or fault conditions, including high speed SWR protection and interlock/muting.
- ❖ monitors the current value of various parameters including cooling fan tachometer outputs, transmitter output forward and reflected power, module temperature, PA current levels, and PA power supply status signals.
- ❖ measures and monitors the output voltage from the power supply modules as well as the low voltage power supplies.
- ❖ generates the signals that enable the power supply modules and control their output voltage.
- ❖ provides the status of any controller fault conditions.
- ❖ contains an integral DSP that performs all audio processing including filtering and FM baseband modulation.
- ❖ interfaces with the RF and power supply sections of the transmitter to perform control and monitoring functions.
- ❖ provides local and remote interfacing for the transmitter. Local interfacing is performed via the local AUI touch screen on the front door of the transmitter and the controller module's front panel UI - a 4 x 20 graphic LCD display - and its adjacent keypad. The AUI and controller UI each contain a menu-based series of pages that serve specific functions. The AUI is also available via remote access. The AUI is a flash graphic that can be used on any web-based PC or handheld device. The remote interface PWB (A16) allows the user a more convenient method to interface with the transmitter from a remote location using discrete wiring.

The primary components of the control/monitor stage are the single-board computer (A4A1) and controller PWB (A4A1), which are part of the controller module (A4) and the module control/interface PWB (A3).

The UI interface PWB (A4A2), also part of the controller module, provides an interface between the controller UI and the module control/interface PWB (A3). It also contains the pushbutton switches (RF ON, RF OFF and LOCAL/REMOTE) and associated status LEDs that protrude through the front panel, adjacent to the UI.

The remote interface PWB (A16) provides a convenient method to remotely control and monitor of the transmitter. It contains push-button switches that provide backup control for the RF on/off, local/remote, power increase/decrease and reset functions. It also contains LEDs that serve as an alternate means to monitor status (local/remote and RF on/off) and various status and alarm parameters.

RF Drive Stage

See electrical schematic Figure SD-3. The RF drive stage converts the exciter's RF output to the intermediate RF level needed to drive the RF power modules. It consists of exciter A (A5), optional exciter B (A6) and RF drive splitter/changeover assembly (A7).

Exciter(s)

Exciter A (A5) and B (A6, optional) are the RF drive sources for the transmitter. They accept the external audio program information (see the GV5/GV3.5 Pre-installation Manual for details on various program input types). For dual exciter applications, the exciters' main/standby operation is controlled using the local (or remote) AUI or the controller UI. The exciter outputs are applied to the RF drive splitter/changeover assembly (A7). The exciter provides a nominal RF drive signal of 11 W (in analog mode).

RF Drive Splitter/Changeover Assembly

See also electrical schematic Figure SD-33. The RF drive splitter/changeover assembly (A7) controls the routing of the main exciter and, if applicable, the standby exciter and provides the RF drive signals for the two RF power modules. The assembly is comprised of the splitter/changeover PWB (A7A1) and the 2-way RF drive splitter/attenuator PWB (A7A2).

Exciter Relay Control - Dual Exciters Only

The RF drive outputs from exciters A and B are applied to the RF drive splitter/changeover assembly at A7A1J1 and A7A1J2 respectively. The Exciter Relay Control input (A7A1J3-4) is a signal applied from the control/monitor stage that controls relay A7A1K1.

- ❖ When exciter A is selected as the main RF drive source, the Exciter Relay Control input is open circuit and relay A7A1K1 will be de-energized. Exciter A's output will be applied to 3 dB hybrid coupler A7A1U1.
- ❖ When exciter B is selected as the main RF drive source, the Exciter Relay Control input is near ground potential (0 V) and relay A7A1K1 will be energized. Exciter B's output will be applied to 3 dB hybrid coupler A7A1U1.

Exciter Drive Splitter

The splitter/changeover PWB's 3 dB hybrid coupler (A7A1U1) is connected as a splitter. The RF drive source (A or B) selected by relay A7A1K1 is applied to A7A1U1's input. The signal is split into two equal amplitude signals that are 90° out-of-phase. These split signals are applied to 2-way RF drive splitter/attenuator PWB A7A2.

2-Way RF Drive Splitter/Attenuator

The 2-way RF drive splitter/attenuator PWB (A7A2) accepts the outputs from the splitter/changeover PWB's 3 dB hybrid coupler and splits it into two equal amplitude signals, using two 3 dB couplers identical to A7A1U1. The outputs of the 3 dB couplers are applied to attenuators, as required, for application to the two RF power modules. Attenuation values are set in order to balance the RF drive output levels.

RF Power Stage

See electrical schematic Figure SD-4. The RF power stage accepts the intermediate RF drive inputs from the RF drive stage and generates the final RF output. It consists of two RF power modules, the module control/interface PWB (A3), a 10 kW combiner/filter (A12), an output power probe (A15), a 2-input reject load assembly (A13) and a 2-way fan tray assembly (A14).

RF Power Module

See electrical schematic Figure SD-34. Each of the two RF power modules provides up to 3000 W (for GV5) or 2250 W (for GV3.5) of RF output power. Each module contains four power amplifier (PA) PWBs (A1 through A4), a splitter/interface PWB (A5), combiner PWBs (A6 and A7), and six cooling fans. The intermediate RF drive outputs from the RF drive stage are applied to the RF power modules via the module control/interface PWB (A3). Within each RF power module, the RF drive signal is sampled and then split to drive the module's four PAs. The PA Volts inputs from the associated power supply modules control the RF output of the four PAs.

Module Control/Interface PWB

See also electrical schematics Figures SD-9 through SD-16. The module control/interface PWB:

- ❖ interfaces with all RF power module inputs and outputs, except for the RF output.
- ❖ interfaces between the controller module (A4) and the rest of the transmitter, distributing forward and reflected power samples, exciter control signals, and metering for reject load assemblies and the RF drive splitter/changeover assembly.
- ❖ distributes RF drive power, PA voltage and PA bias voltage to the RF power modules.
- ❖ monitors critical parameters of the RF power modules, such as RF drive sample, reject power sample, heatsink temperature and cooling fan speed. Monitoring circuits determine if a parameter is out of tolerance and generate the necessary control signal to compensate for the out of tolerance condition or to inhibit the RF power module's associated power supplies.
- ❖ applies control signals to the power supply modules from the controller and also monitors status signals and critical meters from the power supply modules and applies them to the controller. The controller can inhibit the power supply modules, as necessary (RF off, PS Temp alarm), or enable the power supply modules (RF on).
- ❖ generates a sample of the PA voltage applied to each RF power module and applies it to the control/monitor stage.
- ❖ samples the RF power module meters and generates the necessary PA bias voltages for each RF power module's PAs.

Combiner/Filter

The 5 kW combiner/filter (A12) accepts the RF outputs from two RF power modules and uses a 3 dB hybrid coupler to provide a single RF output. The 3 dB hybrid coupler accepts the outputs of two RF power modules. The equal amplitude, 90° out-of-phase (quadrature) RF signals are combined at the 3 dB hybrid coupler output and applied to a 5 kW low pass filter before being applied to the output power probe (A15).

Any amplitude or phase imbalance between the 3 dB hybrid coupler inputs causes a proportional signal to be applied to the reject load assembly's 5kW Rej Ld Pwr (1/2) via J5.

Reject Load Assembly

The reject load assembly (A13) provides a means to dissipate reject power from the outputs of the combiner/filter's 3 dB hybrid couplers. The reject load assembly contains power resistors to dissipate reject power. Cooling air for the reject load assembly is provided by fans in the fan tray assembly (A14). The module control/interface PWB (A3) monitors the speed of the cooling fans and regulates the voltage being applied to them accordingly.

Reject power generated by the combining stage of the combiner/filter is dissipated by resistors in the 1-input reject load assembly. Micro-strip transmission lines (on 2-input reject load PWB A13A1) in close proximity to the reject load signals induce one true RF sample voltage of the associated reject power. This sample is peak detected and applied to the control/monitor stage via the module control/interface PWB (A3). The module control/interface PWB provides an interface between the ac-dc power stage's Rej Fan Volts supply and the fan tray assembly's cooling fans. It also acts as the interface between the cooling fans' Rej Fan Tach signals and the control/monitor stage.

Output Power Probe

See electrical schematic Figure SD-36. The output power probe (A15) monitors the transmitter's forward and reflected power and generates the Fwd Pwr Sample (A1J1) and Refld Pwr Sample (A2J1) signals applied to the control/monitor stage for protection and monitoring. RF monitor PWB A3 provides a nominal 1.6 V (GV5) or 1.3 V (GV3.5) rms [at 5 kW (GV5) or 3.75 kW (GV3.5)] signal at A3J1, which is applied to the panel mount connector (W8J1) behind the front door. This can be used with a modulation monitor or spectrum analyzer. RF sample PWBs A4 and A5 provide similar samples at A4J1 and A5J1. These samples are applied to exciter B (if used) for use by the remote AUI's spectrum analyzer display.

GV3.5 / GV5 BLOCK DIAGRAM

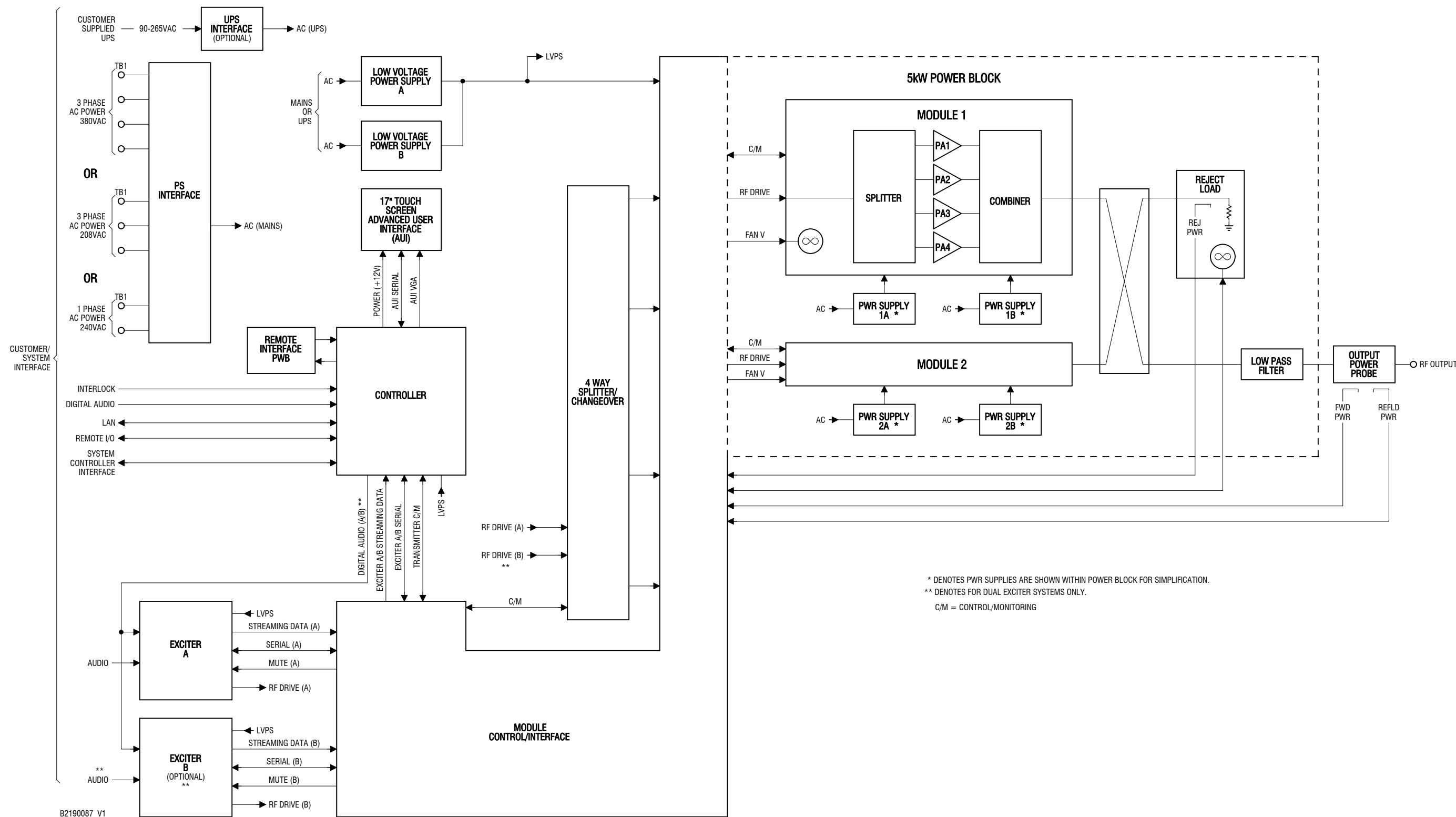
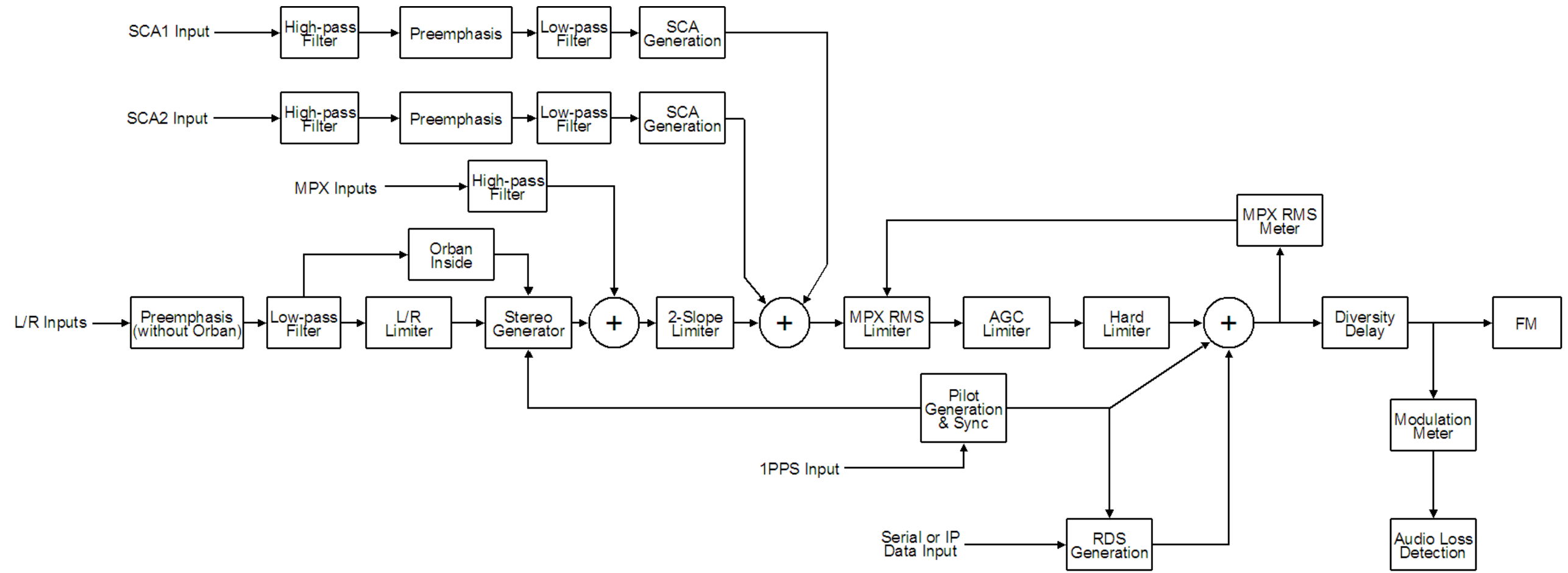

Figure 3.1.1: GV5/GV3.5 Transmitter Block Diagram



:[i fY" "%& ; J)# J' ") '5i X]c'DUH '6cV\ '8]U[fUa

SECTION 3.2: OPERATING THE TRANSMITTER

This section provides information about operating the GV5/GV3.5 transmitter:

- [User Interface Options](#) - see page 3.2.4
 - [Advanced User Interface \(AUI\)](#) - see page 3.2.9
 - [Controller Front Panel](#) - see page 3.2.17
- [Home Page](#) - see page 3.2.24
- [Menu Page - Describing Transmitter Operations](#) - see page 3.2.25
- [Viewing Transmitter Log](#) - see page 3.2.27
 - [Transmitter Log - Using the AUI](#) - see page 3.2.27
 - [Transmitter Alarms and Log - Using the Controller UI](#) - see page 3.2.36
- [Viewing Tool Menu Panels](#) - see page 3.2.37
- [Viewing Real-Time Meters](#) - see page 3.2.53
 - [Viewing Real-Time Meters - using the AUI](#) - see page 3.2.53
 - [Viewing Real-Time Meters - using the Controller UI](#) - see page 3.2.57
- [Presets - Editing Operational Settings](#) - see page 3.2.60
 - [Managing Presets - using the AUI](#) - see page 3.2.60
 - [Managing Presets - using the Controller UI](#) - see page 3.2.74
- [Resetting Alarms](#) - see page 3.2.98
- [Viewing Transmitter Status - using the AUI](#) - see page 3.2.99
- [System Settings - using the AUI](#) - see page 3.2.101
 - [Reset](#) - see page 3.2.102
 - [Upgrade Software](#) - see page 3.2.103
 - [Exciter TCXO](#) - see page 3.2.105
 - [IBOC Settings](#) - see page 3.2.106
 - [Spectrum/Efficiency Optimizer](#) - see page 3.2.108
 - [Hardware Configuration](#) - see page 3.2.109
 - [FM Polarity](#) - see page 3.2.111
 - [Audio Input Calibration](#) - see page 3.2.112

- System Settings - using the Controller UI - see page 3.2.113
 - Resetting the Single-Board Computer (SBC) - see page 3.2.114
 - Configuring SBC Watchdog - see page 3.2.114
 - Updating Firmware - see page 3.2.115
 - Adjusting Display Settings - see page 3.2.115
 - Setting Exciter TCXO Offset - see page 3.2.117
 - Optimizing HD Parameters - see page 3.2.118
 - Configuring Installed Hardware - see page 3.2.120
 - FM Polarity - see page 3.2.124
 - Adjusting Factory Settings - see page 3.2.125
- User Accounts - see page 3.2.130
 - Setting User Permission Level - see page 3.2.131
 - Editing Account Information - see page 3.2.131
 - First-Time Login - see page 3.2.133
- Changing Exciter Transfer Settings - see page 3.2.134
 - Exciter Changeover Settings - using the AUI - see page 3.2.134
 - Exciter Changeover Settings - using the Controller UI - see page 3.2.135
- User Settings - AUI - see page 3.2.137
 - Network Setup - see page 3.2.138
 - Email Configuration - see page 3.2.143
 - Notifications - see page 3.2.145
 - Configuring Engine Settings - see page 3.2.147
 - Nautel Phone Home - see page 3.2.149
 - SNMP Configuration - see page 3.2.150
 - Capturing Critical Parameters - see page 3.2.152
 - Using an External 10 MHz Input - see page 3.2.153
 - Spectrum Mask - see page 3.2.155
 - Setting the Clock - see page 3.2.156
 - Configuring NTP Servers - see page 3.2.159
 - Setting User Thresholds - see page 3.2.161
 - Setting Call Sign/ID - see page 3.2.164
 - Turn-On Behaviour - see page 3.2.165

- User Settings - Controller UI - see page 3.2.166 (additional settings to those included under AUI)
 - Setting Pilot Sample Level - see page 3.2.167
 - Configure Test Signal Generator - see page 3.2.168
 - Selecting FM Mask - see page 3.2.170
 - Turn-On Delay Setting - see page 3.2.171
 - Ramp-Up Speed Setting - see page 3.2.172
- Configuring Remote Inputs and Outputs - see page 3.2.173
 - Remote I/O Settings - using the AUI - see page 3.2.173
 - Remote I/O Settings - using the Controller UI - see page 3.2.179
 - Monitoring Analog Outputs - see page 3.2.182
 - Site Control Settings - see page 3.2.184
- Preset Scheduler - see page 3.2.187
 - Enabling the Scheduler - see page 3.2.189
- Audio Player - see page 3.2.190
- Enabling and Operating the Orban Audio Processor - see page 3.2.196
 - Configuring the Transmitter for the Orban Audio Processor - see page 3.2.197
 - Enabling the Orban Audio Processor for Preset Selection - see page 3.2.199
 - Selecting an Orban Audio Processor Preset - see page 3.2.202
 - Managing an Orban Audio Processor Preset - see page 3.2.204

User Interface Options

The user can interface with the GV5/GV3.5 using one of four methods:

- Locally, using the 17-inch front panel touch screen AUI (advanced user interface) (see [Advanced User Interface \(AUI\)](#), on page 3.2.9).
- Locally, using the controller module's front panel display and its navigational buttons (see [Controller Front Panel](#), on page 3.2.17) and the RF On, RF Off and Local/Remote control push-buttons (see [Controller Pushbuttons](#), on page 3.2.19). This interface is considered a backup to the local AUI.
- Remotely, via a LAN connection, using the advanced user interface (AUI) pages (same as local AUI interface).
- Remotely, via remote input/output (I/O) wiring connected to the controller (A4) or the remote interface PWB (A16) (see the GV5/GV3.5 Pre-installation Manual for I/O details).

See the complete menu hierarchy illustrated in Figure 3.2.1 (for the local/remote AUI menu) and Figures 3.2.2 and 3.2.3 (for the controller UI menu). When a user interfacing function can be performed from both the AUI and the controller UI, both are described in this section.

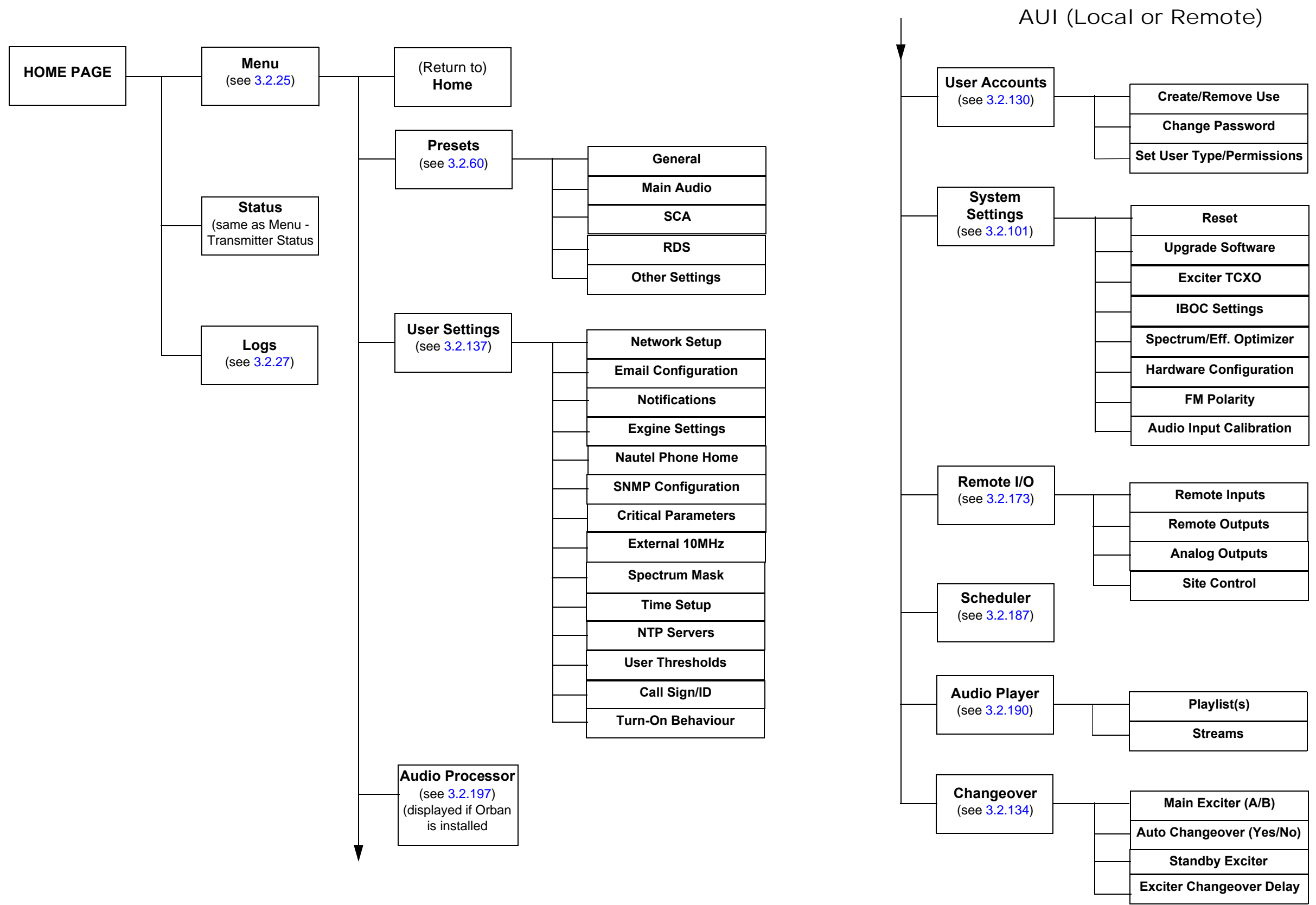

Figure 3.2.1: GV Transmitter AUI Flow Diagram

Controller UI

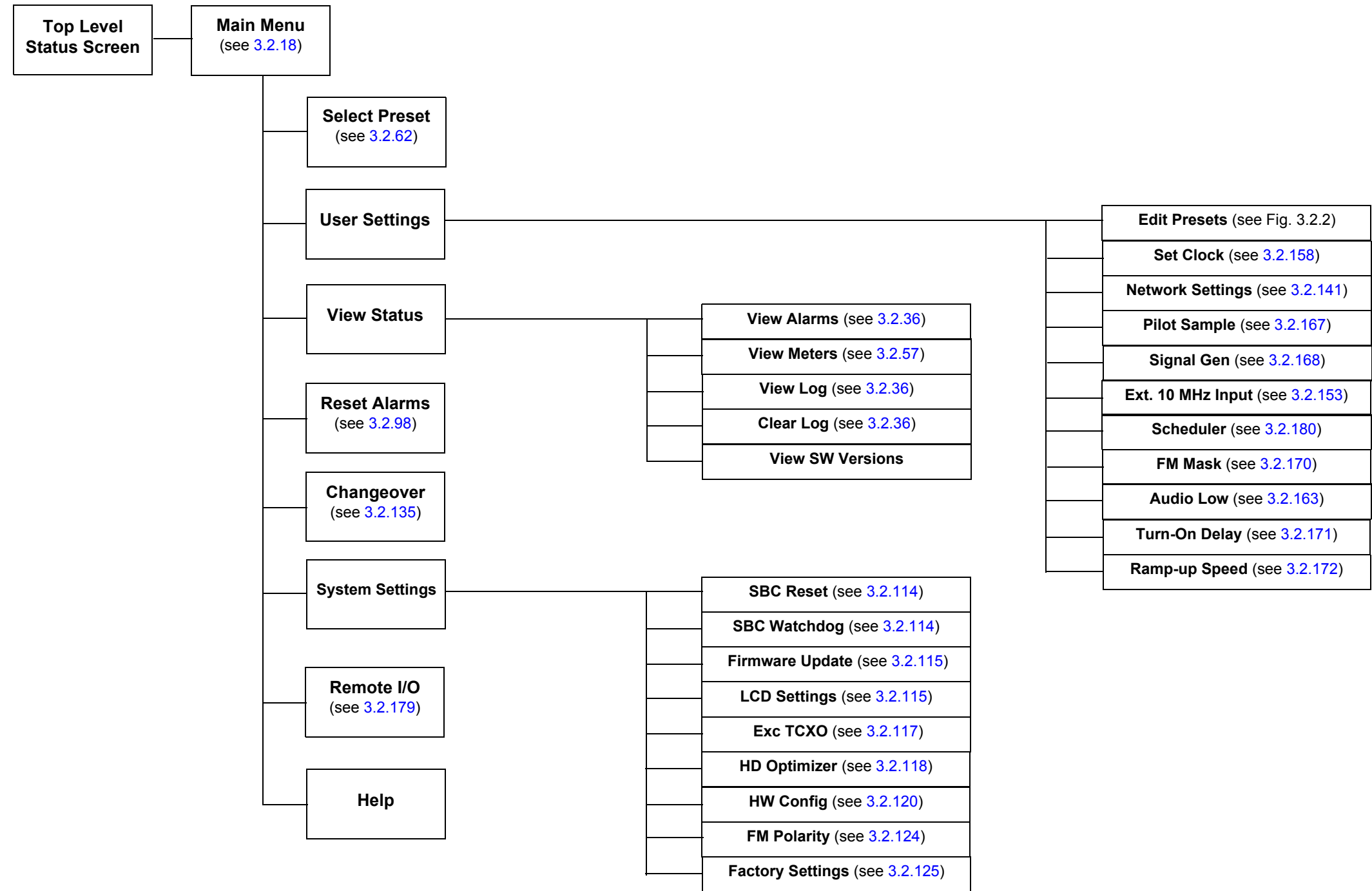

Figure 3.2.2: GV Transmitter - Controller UI Menu Tree (Sheet 1 of 2)

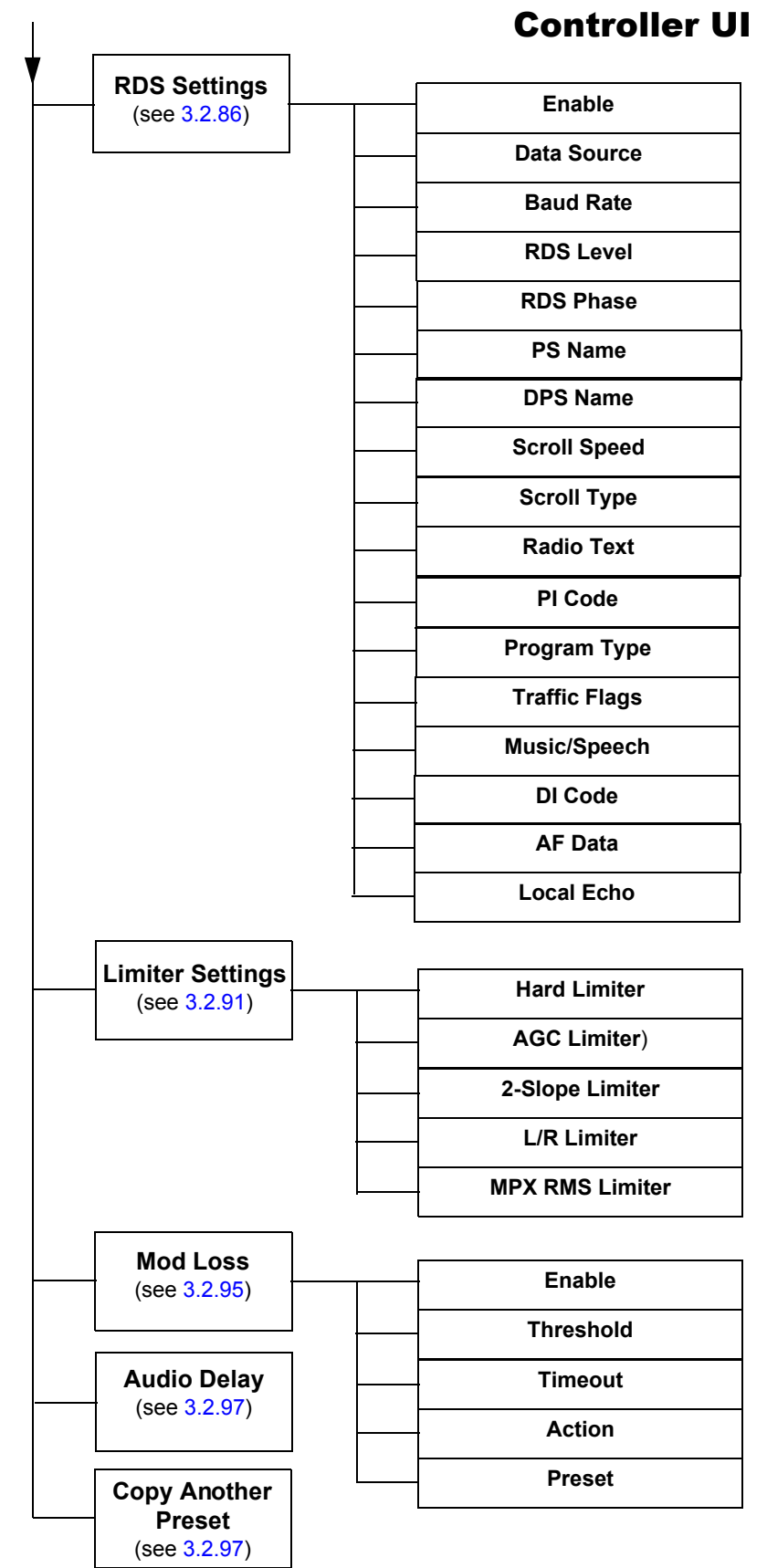
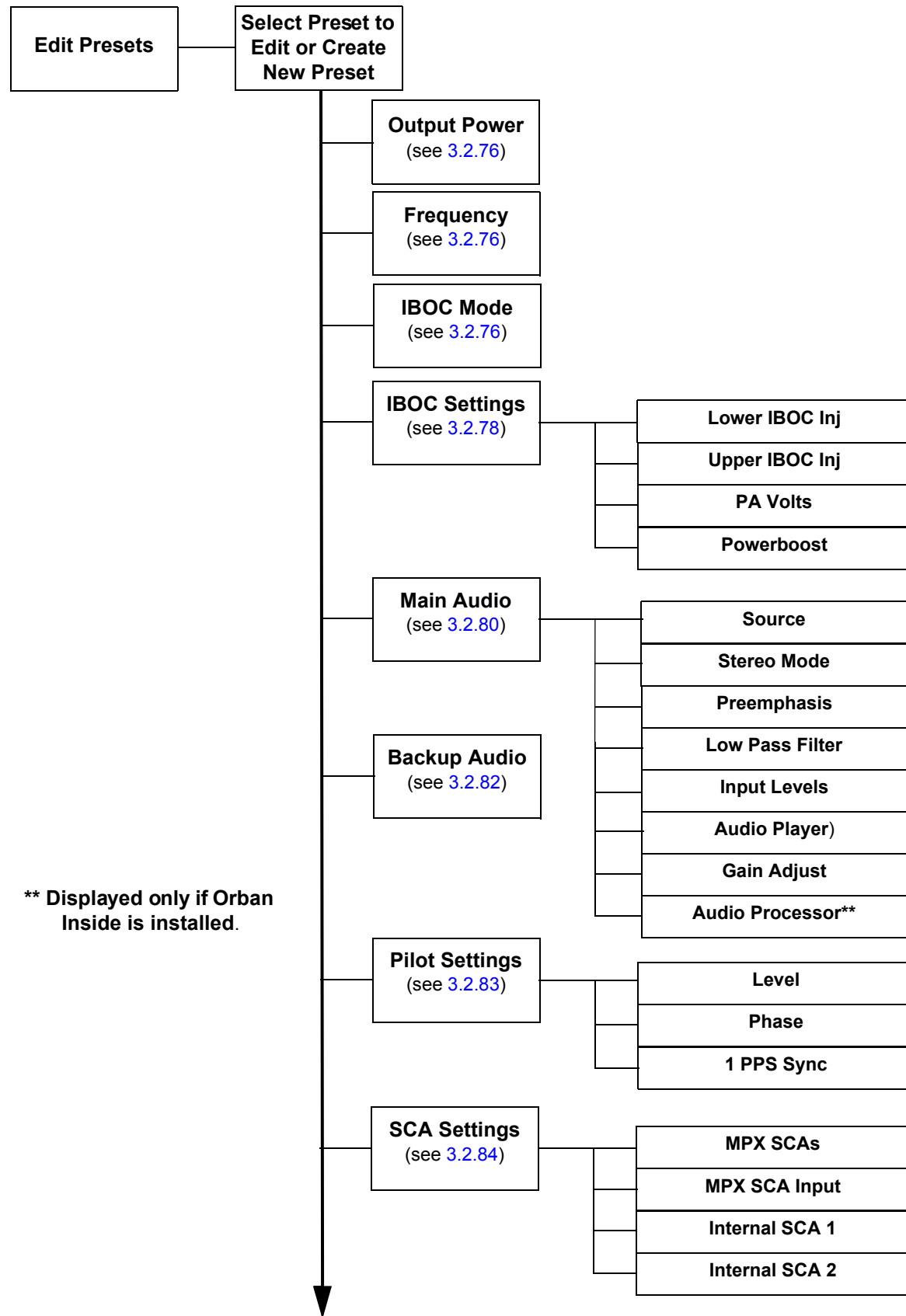

Figure 3.2.3: GV Transmitter - Controller UI Menu Tree - Edit Presets (Sheet 2 of 2)

Advanced User Interface (AUI)

The GV5/GV3.5 has an advanced user interface (AUI) that is displayed on a 17-inch, colour LCD screen mounted on the front of the transmitter (see [Figure 3.2.4](#)). You can access the AUI:

- locally via the touch screen, or
- remotely using a PC and a web browser, directly or through a switch or network - via the controller module's (A4) rear panel LAN connection or the remote interface PWB's (A16) LAN connection (J1), behind the front door.

This section includes the following topics:

- [Logging into the AUI, on page 3.2.10](#)
- [Describing the AUI Layout, on page 3.2.12](#)
- [List of AUI Pages, on page 3.2.13](#)
- [Navigating from Page to Page, on page 3.2.16](#)

Figure 3.2.4: GV5/GV3.5 AUI

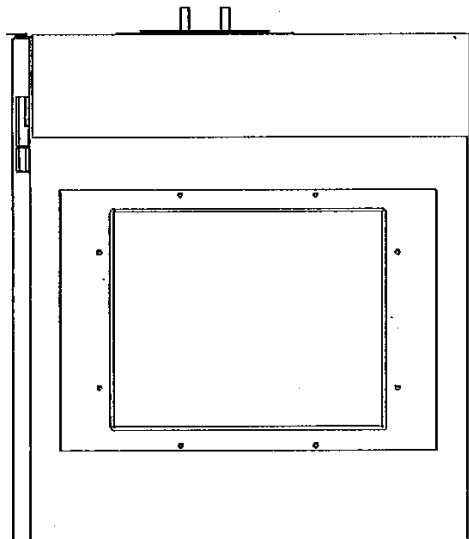

Logging into the AUI

The transmitter's AUI provides a means to restrict local and remote access to transmitter control functions to authorized users only. Users can create accounts that can be pre-defined to set access restriction from view-only (no control), full control (all permissions), custom (select permissions) and administrative control.

Remote Access

To access the transmitter's AUI remotely, perform the following steps:

1. Configure your network settings (see [Network Setup, on page 3.2.138](#)).
2. On your router or firewall software, open ports 3501 (3501 is factory default; use corresponding other port if changed) and 80 and close (restrict access to) all other ports. If you are using RDS data, open port 7005. If you are using SNMP, open ports 161 (Agent) or 162 (Traps).
3. When properly configured as noted above, the login menu (see [Figure 3.2.5 on page 3.2.10](#)) will appear in your web browser when the IP address is accessed. Your IP address and any login messages appear in a box at the top, beside the logo.

Figure 3.2.5: AUI Login Menu

IP address and login messages

The screenshot shows the AUI Login Menu. At the top left is the Nautel logo. To its right, a red-bordered box contains the text: "Connected to 10.0.96.55:3501" and "Please enter a username and password." Below the logo is a "Language" dropdown menu currently set to "English (1.0)". To the right of the dropdown is a separate box titled "shown for reference only" containing a list of languages: "English (1.0)", "Türk (1.0)", "中文 (1.1)", and "Español (1.0)". Below the language dropdown are input fields for "User" and "Password", and a "Submit" button at the bottom right. Red arrows point from the text "IP address and login messages" to the connection message box, and from the text "shown for reference only" to the language selection dropdown.

-
4. Log in to the AUI by entering the appropriate parameters in the login window.
 - In the Language field, press the down-arrow to review a drop-down menu displaying the available language options, and select one.
 - In the User field, enter the username. Default is "Nautel".
 - In the Password field, enter the password. Default is blank.

NOTE: The Nautel AUI is factory configured with a default login username and password. Nautel recommends that you change the password to improve overall system security. See [Changing the Password, on page 3.2.132](#).

- Press Submit to accept your login parameters and display the AUI home page ([Figure 3.2.11 on page 3.2.24](#)). Note: The opening screen (the Home page) will have the layout from the previous login session.

NOTE: If you do not have a user account, it must be set up by an existing user with proper permissions. See [Adding an Account, on page 3.2.131](#).

NOTE: If no login attempt is made after 60 seconds, a timeout feature will be activated and the web browser will need to be refreshed or the Retry button pressed (appears on AUI window after timeout) in order to attempt another login.

Local Access

When properly configured, (but without auto login selected) the login menu will appear on the transmitter 17-inch LCD touchscreen. Log into the AUI by entering the appropriate parameters in the login window.

- In the Language field, press the down-arrow to review a drop-down menu displaying the available language options, and select one.
- In the User field, enter the username. Default is "Nautel".
- In the Password field, enter the password. Default is blank.
- Press Submit to accept your login parameters and display the AUI home page ([Figure 3.2.11 on page 3.2.24](#)). Note: The opening screen (the Home page) will have the layout from the previous login session.
- If auto login is set the AUI will appear automatically without the required previous steps (see [Setting Auto Login \(Local Only\) Status on page 3.2.132](#)).

Describing the AUI Layout

The AUI begins with the Home page and all further navigation will start from this screen (see [Figure 3.2.6 on page 3.2.14](#)).

Any user can view the AUI pages on the front panel of the transmitter, regardless of the login status; however, only users with the appropriate permission level can access functions that alter the transmitter control settings.

Users can access the login menu by pressing the Change User button located in the bottom banner of the AUI when logged in locally. It should be noted that this same button is shown as Log Out if viewing the AUI remotely (see [Figure 3.2.6 on page 3.2.14](#)).

List of AUI Pages

Table 3.2.1 defines the available AUI pages.

Table 3.2.1: AUI Pages

AUI Page	Function	See Page
Home	View meters, tool menu panels, choose options and navigate to other pages.	page 3.2.24
Menu	Choose options and navigate to other pages.	page 3.2.25
Transmitter Status	View transmitter's current active faults and operational status.	page 3.2.99
Transmitter Log	View transmitter event history.	page 3.2.27
Tool Menu	Choose tool menu panel options.	page 3.2.37
Meters List View	Choose meters for display.	page 3.2.53
Presets	Edit user-defined presets.	page 3.2.60
User Settings	Set network information, configure email and alarm notification parameters, configure Engine interface information, configure SNMP information, capture critical parameters, set time and date, enable/configure NTP servers, set call sign/ID, set user thresholds (audio and forward power alarms), set turn-on behaviour.	page 3.2.137
User Accounts	Set user permission rights and define user account information.	page 3.2.130
System Settings	Users determine critical system configuration parameters.	page 3.2.101
Remote I/O	Define remote digital inputs/outputs and configure analog outputs.	page 3.2.173
Scheduler	Define a preset schedule for daily/monthly operation.	page 3.2.187
Audio Player	Manage audio playlist and stream sources.	page 3.2.188
Changeover	Set main exciter and auto exciter changeover function. Icon displays only if configured for dual exciter operation.	page 3.2.134
Audio Processor	Configure the transmitter for use with the Orban Inside option, if applicable. Icon displays only if Orban Inside is installed.	page 3.2.187

Each AUI page provides information about a specific transmitter function. All navigation through the AUI pages begins on the main screen shown in [Figure 3.2.6 on page 3.2.14](#).

Figure 3.2.6: Using the AUI

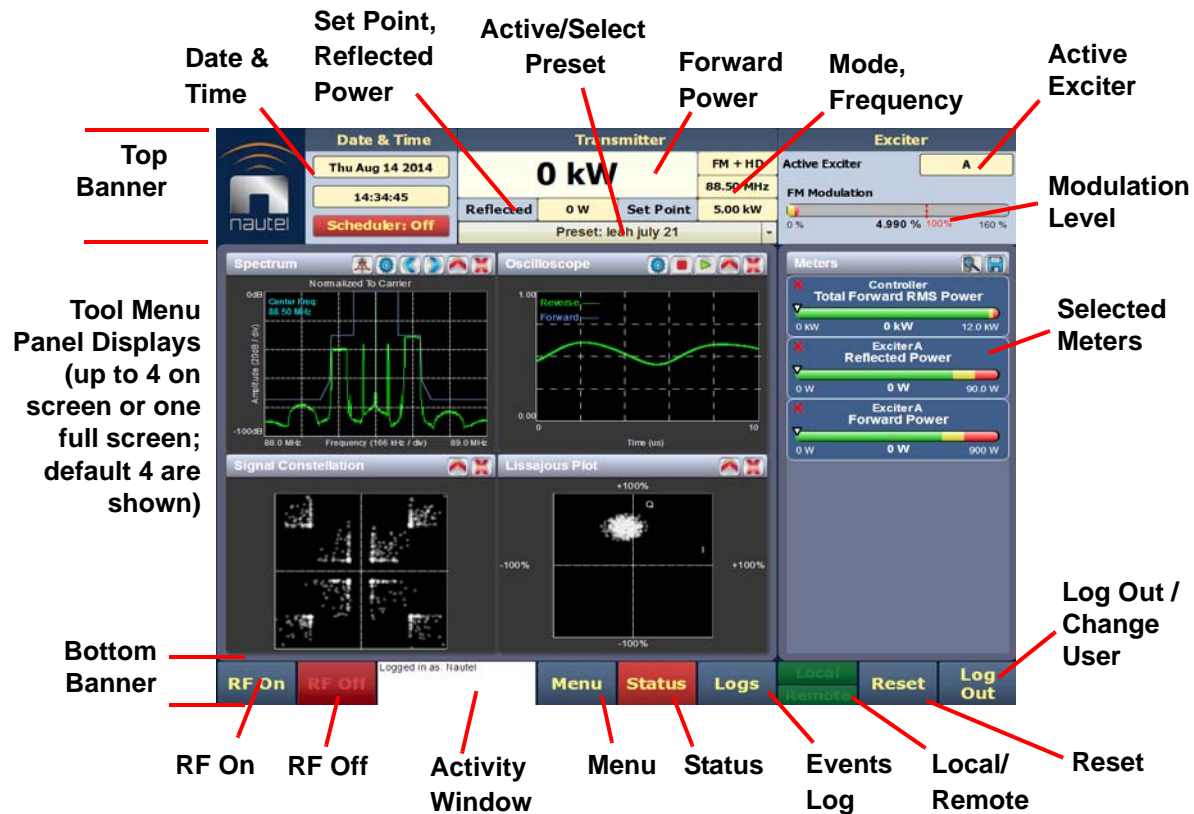

The top banner is permanent on all AUI pages and includes:

- Logo: From any AUI page, press the displayed logo to return to the Home page.
- Date & Time: Displays the date (including day of the week, month, day and year) and current time (see [Setting the Clock, on page 3.2.156](#)).
- Transmitter: Displays the name of the active preset, current forward power (and power set point based on the active preset) and reflected power levels as well as the operating mode (FM, FM+HD, HD, etc.) and carrier frequency. (see [Managing Presets - using the AUI, on page 3.2.60](#)). Press Menu/Presets (bottom panel) to open the Presets page and edit this information. Also the call Sign/ID is displayed here (see [Setting Call Sign/ID, on page 3.2.164](#)).
- Preset: Displays the active preset. Press this area to open the Activate Preset menu and select the active preset.

- Exciter: Displays the active exciter and the peak (red) FM modulation value. Press in the Active Exciter field to shortcut to the Changeover page. The active exciter is displayed in the top, right corner (see [Figure 3.2.11](#)).
- Forward Power: Displays the analog power output when in FM or FM +HD modes and displays the HD power output when in HD (only) mode.

The bottom banner is also permanent on all AUI pages and includes the following buttons, some of which open other menus and displays:

- RF On: Press to enable the transmitter's RF power stage. When the button is highlighted green, RF is enabled (on). When the button is highlighted amber, a fault condition exists that is preventing the RF power stage from turning on.
- RF Off: Press to disable the transmitter's RF power stage. When button is highlighted in red, RF is disabled (off).
- Activity Window: Displays various messages to reflect specific user interface commands, such as which user is logged in, if the transmitter RF is held off, etc.
- Menu: Press to open the Menu page, which allows navigation to various other pages (see [Menu Page - Describing Transmitter Operations on page 3.2.25](#)).
- Status: Press to open the Transmitter Status page (see [Viewing Transmitter Status - using the AUI on page 3.2.99](#)), which provides current alarm and status details for the transmitter. When the Status button is red, one or more alarms of "high" severity is currently being reported and the transmitter is in an 'off-air' state. When the Status button is amber, "medium" or yellow "low" one or more lower level alarms is currently being reported, but the transmitter is still 'on-air', possibly at reduced power. When the Status button is green, the transmitter is operating normally. In this case there are no alarms being reported.
- Logs: Press to shortcut to the Transmitter Log page, which displays historical alarm and status records for the transmitter (see [Viewing Transmitter Log on page 3.2.27](#)).
- Local/Remote: Displays the operational control status of the transmitter. From the touch screen, press the desired button. If Local is highlighted green, only local control of the AUI is possible. If both Local and Remote are highlighted green, both local and remote controls are enabled.
- Reset: Press to reset protection circuits and restore any RF power modules (and associated power supplies) that were inhibited, but are now alarm-free.
- Change User/Log Out: Press to display a login menu. Enter your username and password, then press Done. If you do not have a user account, see [User Accounts, on page 3.2.130](#). Change User button will display as Log Out while viewing AUI remotely.

The displays between the top and bottom menus, contains user selected pages. These pages provide access to a variety of AUI functions such as transmitter status and hardware settings. The following paragraphs describe how to use these pages.

- **Tool Menu:** Display up to four panels on the screen at one time. To reveal the Tool Menu options, press **X** in the upper right corner of one panel to close an existing panel, and then press in the blank space to display a menu of panels (see [Describing Instrument Panel Options on page 3.2.38](#)).
- **Meters:** Displays the real-time meters that provide a system review of the transmitter (see [Viewing Real-Time Meters - using the AUI on page 3.2.53](#)).

Navigating from Page to Page

You can easily navigate through the AUI from its Home page (see [Figure 3.2.11 on page 3.2.24](#)) or Menu page (see [Figure 3.2.12 on page 3.2.25](#)). During navigation, all Menu pages will feature a red exit page button (see [Figure 3.2.7](#)). Press this button to exit the Menu page you are on and return to the Home page.

Figure 3.2.7: Exit Page Button



Press this button to exit all menu pages.

Controller Front Panel

The controller's front panel has a user interface (UI) featuring a 4 x 20 character graphic LCD display (see [Figure 3.2.9 on page 3.2.18](#)). The UI can be controlled by its adjacent keypad. The UI contains a menu-based series of pages that serve specific functions. Similar interfacing, as well as more advanced functionality, is available on the AUI (see [Advanced User Interface \(AUI\), on page 3.2.9](#)). The controller front panel also has push-button switches that allow RF on, RF off and local/remote selection (see [Navigational Buttons, on page 3.2.18](#)).

LCD Display (UI)

This display shows all the UI screens. The display's top level screen, used for viewing purposes only, is shown in [Figure 3.2.8](#).

Figure 3.2.8: Top Level Screens

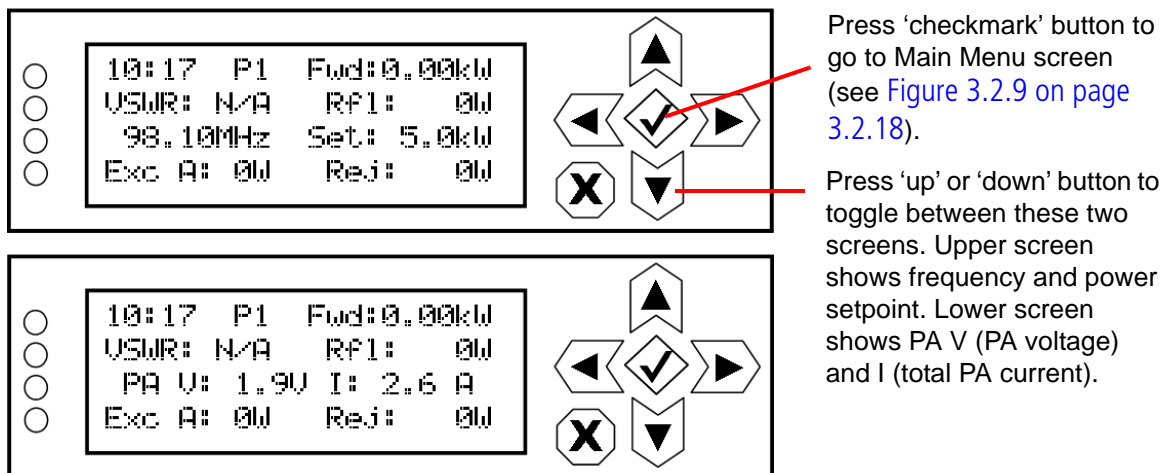

The top level screen displays the following information:

- ❖ Line 1: current time, active preset (e.g., P1) and the transmitter's actual forward power.
- ❖ Line 2: VSWR ratio and the transmitter's reflected power level.
- ❖ Line 3: operating frequency and the desired power setpoint (or PA voltage and total PA current).
- ❖ Line 4: active exciter's forward power level and the total system reject power.

Main Menu

This main menu is the starting point for navigating through the UI screens. See [Table 3.2.2 on page 3.2.20](#) for a list of screens and their basic functions.

Figure 3.2.9: Main Menu

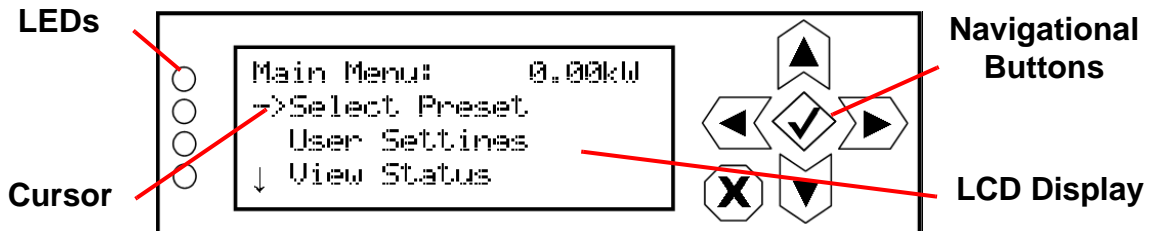

Navigational Buttons

There are six push-buttons on the right-hand side of the LCD display that allow navigation through the UI pages, as well as modifying selected settings.

- ❖ Up and down - on menu and list screens, moves cursor up and down through the associated page; on edit screens, increases and decreases the value of a parameter being modified.
- ❖ Left - on menu and list screens, exits to the next higher level screen; on edit screens, moves the editing cursor left, as applicable.
- ❖ Right - on menu and list screens, goes to the next lower level screen; on edit screens, moves the editing cursor right, as applicable.
- ❖ Checkmark - on menu screens, goes to the next lower level screen; on edit screens, acts as an "accept" or "save" function; in some cases the display will prompt its use.
- ❖ X - on menu and list screens, exits to the next higher level screen; on edit screens, acts as a "cancel" function; in some cases the display will prompt its use.

Saving Settings

Many of the UI screens allow for modifying a selected setting. Use the checkmark button to save a change. Use the X button to cancel a change and revert back to the previously stored value.

LEDs

There are four LEDs on the left-hand side of the LCD display that provide the operational status of various sections of the transmitter - Exciter, Power Amplifier, Output Network and Power Supply (see [Figure 3.2.9 on page 3.2.18](#)). The LEDs can glow green, amber or red. Typically, green indicates normal operation, amber indicates a warning, and red indicates a fault or error. Refer to the Troubleshooting section for more detailed information on LED status.

Controller Pushbuttons

The front panel contains three pushbutton switches that provide local control of the transmitter's RF on/off status and the local/remote operational control status (see [Figure 3.2.10](#)).

Figure 3.2.10: Front Panel Pushbutton Switches

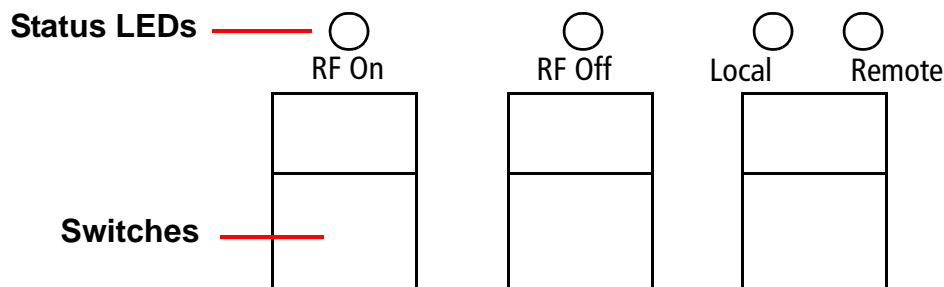

- ❖ RF On - In local mode, press the pushbutton switch to turn on the RF power stage and cooling fans. The RF On LED will be on (amber) when the RF power stage is on and the external interlock circuit is intact. The transmitter will operate at the level stored in the selected preset.
- ❖ RF Off - Regardless of the remote enable/disable status, press the pushbutton switch to turn off the RF power stage. The RF Off LED will be on (amber) when the RF power stage is off.

NOTE: The RF On and RF Off LEDs may blink if there are alarms occurring that prevent the transmitter from enabling the RF power stage (e.g., interlock open, combiner matching, etc.)

- ❖ Local/Remote - Press the switch to toggle between "remote enabled" (Remote amber LED on; local and remote control) and "remote disabled" (Remote LED off; local control only). The transmitter's local controls are always enabled. In Local mode (Local amber LED on), all of the remote controls (except the external interlock) are disabled. In Remote mode, control of transmitter functions is also provided to the remote (web-accessed) AUI or remote input/output control via the remote interface PWB or the rear of the controller module. The bottom of the remote AUI home page will display the control status. When remote control is enabled, only the Remote button is green. When remote control is disabled, only the Local button is green.

Controller UI Screens

Table 3.2.2 defines the available UI display screens on the controller module.

Table 3.2.2: Controller UI Screens

Controller UI Screen	Function	See Page
Main Menu	Choose options and navigate to other screens.	page 3.2.18
Select Preset	Select and activate a user-defined preset.	page 3.2.74
User Settings	Edit various transmitter user settings (see other User Settings options in this table).	-
User Settings - Edit Presets	Edit various parameters for a user-defined preset (see the following rows for all Edit Presets options).	page 3.2.75
User Settings - Edit Presets - Output Power	Edit the selected preset's output power.	page 3.2.76
User Settings - Edit Presets - Frequency	Edit the selected preset's operating frequency.	page 3.2.76
User Settings - Edit Presets - IBOC Mode	Edit the selected preset's mode of operation (FM, FM+HD, HD or DRM+).	page 3.2.76
User Settings - Edit Presets - IBOC Settings	Edit the selected preset's settings for IBOC (digital) operation.	page 3.2.78
User Settings - Edit Presets - Main Audio	Edit the selected preset's main audio characteristics such as source, stereo mode, pre-emphasis and low pass filtering.	page 3.2.80
User Settings - Edit Presets - Backup Audio	Enable and edit the selected preset's backup audio characteristics such as source, stereo mode, pre-emphasis and low pass filtering.	page 3.2.82
User Settings - Edit Presets - Pilot Settings	Edit the selected preset's pilot settings such as level, phase and 1 PPS synchronization.	page 3.2.83
User Settings - Edit Presets - SCA Settings	Edit the selected preset's SCA settings such as SCA reduction, MPX SCAs, MPX SCA input and internal SCA (1 and 2) generator characteristics.	page 3.2.84
User Settings - Edit Presets - RDS Settings	Edit the selected preset's RDS settings such as enable/disable, data source, baud rate, level, phase, program type, alternate frequency data, etc.	page 3.2.86
User Settings - Edit Presets - Limiter Settings	Edit the selected preset's limiter settings. Limiter types include hard limiter, AGC limiter, 2-slope limiter, L/R limiter and MPX RMS limiter.	page 3.2.91

Table 3.2.2: Controller UI Screens

Controller UI Screen	Function	See Page
User Settings - Edit Presets - Mod Loss	Edit the selected preset's modulation loss functionality, such as enable/disable, setting threshold, setting timeout period, setting resulting action and selecting a backup preset.	page 3.2.95
User Settings - Edit Presets - Audio Delay	Edit the selected preset's audio delay.	page 3.2.97
User Settings - Edit Presets - Copy Another Preset	Copy the selected preset's settings to another preset.	page 3.2.97
User Settings - Set Clock	Set precise time and date.	page 3.2.158
User Settings - Network Settings	View and/or set network information such as MAC address (view only), DHCP on/off status, IP address, netmask and gateway.	page 3.2.141
User Settings - Pilot Sample	Set the pilot sample level for the controller's rear panel BNC connector.	page 3.2.167
User Settings - Signal Gen	Enable/disable and setup the internal signal generator.	page 3.2.168
User Settings - Ext. 10 MHz Inp	Enable/disable the use of an external 10 MHz signal.	page 3.2.154
User Settings - Scheduler	Enable/disable the scheduler.	page 3.2.189
User Settings - FM Mask	Select the FM mask - FCC, ETSI or None (turns off mask).	page 3.2.170
User Settings - Audio Low	Set the low audio thresholds and associated timeout delays.	page 3.2.163
User Settings - Turn-On Delay	Set the transmitter turn-on delay period.	page 3.2.171
User Settings - Ramp-Up Speed	Set the transmitter's ramp-up delay period.	page 3.2.172
View Status	View various transmitter parameters (see other View Status options in this table).	-
View Status - View Alarms	View all active transmitter alarms.	page 3.2.36
View Status - View Meters	View the levels of various transmitter parameters, including forward power, reflected power, PA voltage, PA current and low level dc supply voltages.	page 3.2.57
View Status - View Log	View the transmitter's events log, including alarms, commands, etc.	page 3.2.36
View Status - Clear Log	Clear the transmitter's events log.	page 3.2.36

Table 3.2.2: Controller UI Screens

Controller UI Screen	Function	See Page
View Status - View SW Versions	View the versions of software installed on the transmitter.	-
Reset Alarms	Initiate an attempt to reset all alarms controlled by latched protection circuits.	page 3.2.98
Changeover	For dual exciters, controls the auto exciter transfer function. You can also enable the standby exciter test function (local control only).	page 3.2.135
System Settings	Edit various transmitter system settings (see other System Settings options in this table).	-
System Settings - SBC Reset	Initiate a reset of the SBC.	page 3.2.114
System Settings - SBC Watchdog	Enable, disable or force a reset of the SBC watchdog feature.	page 3.2.114
System Settings - Firmware Update	Perform a software upgrade on the transmitter.	page 3.2.115
System Settings - LCD Settings	Set the front panel display's contrast, backlight and timeout.	page 3.2.115
System Settings - Exciter TCXO	Calibrate the internal clock to a user supplied external high precision 10 MHz clock reference	page 3.2.117
System Settings - HD Optimizer	Set parameters for the HD Optimizer feature, which can be used to maximize the efficiency of the transmitter's RF spectrum.	page 3.2.118
System Settings - HW Config	Configure various system hardware parameters (see other System Settings - HW Config options in this table).	-
System Settings - HW Config - Installed Exc	Configures the transmitter for single or dual exciter installation.	page 3.2.121
System Settings - HW Config - LVPS Hardware	Configures the transmitter for single or redundant LVPS installation.	page 3.2.121
System Settings - HW Config - LVPS Voltage	Set the normal-state level of the low voltage power supply.	page 3.2.122
System Settings - HW Config - Fan Speed	Set the normal-state speed of the transmitter's cooling fans.	page 3.2.123
System Settings - HW Config - UPS Installed	Set the transmitter for UPS operation.	page 3.2.123
System Settings - HW Config - Audio Processor	Set audio processor to none or Orban Inside.	page 3.2.200

Table 3.2.2: Controller UI Screens

Controller UI Screen	Function	See Page
System Settings - FM Polarity	Set the polarity for FM deviation; positive modulation signal yields positive frequency deviation or negative modulating signal yields positive frequency deviation.	page 3.2.124
System Settings - Factory Settings	Sets critical thresholds, calibration values and operating values for key transmitter parameters. These settings are established at the factory and do not normally require user adjustment (see other System Settings - Factory Settings options in this table).	page 3.2.125
System Settings - Factory Settings - Thresholds	Set protection thresholds for various parameters (e.g., SWR shutback, high/low exciter power, low/very low forward power, etc.).	page 3.2.126
System Settings - Factory Settings - Calibration	Set calibration values or run calibration routines for various parameters (e.g., forward/reflected power, program input levels, etc.).	page 3.2.127
System Settings - Factory Settings - Exciter Power	Set the normal operating power level for the active exciter, in FM mode.	page 3.2.129
System Settings - Factory Settings - Exciter HD PA V	Set the HD exciter's PA voltage.	page 3.2.129
Remote I/O	Configure the remote digital inputs, digital outputs and analog outputs for the transmitter.	page 3.2.173

Home Page

The Home page (see [Figure 3.2.11](#)) is the first screen to appear when you login into the AUI. You can return to the Home page, from any screen, by pressing on the logo (upper left corner) or by pressing Menu > Home.

Figure 3.2.11: Home Page

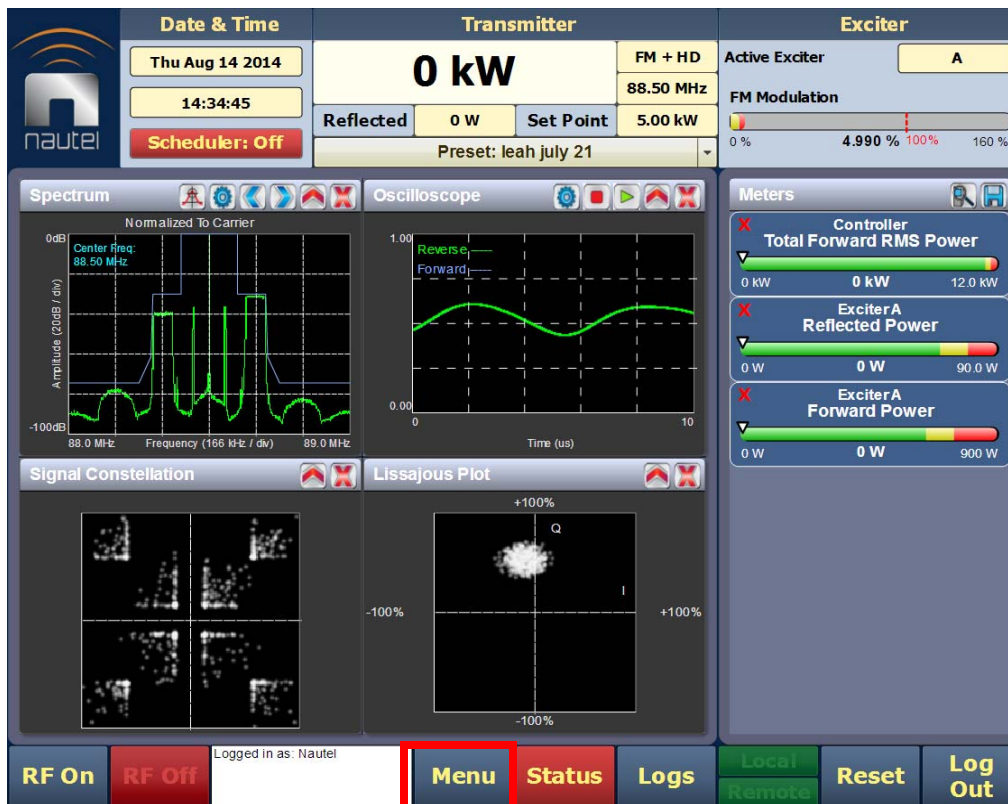

Press the Menu button to view the various sub-menu options (see [Figure 3.2.12](#) on page 3.2.25).

Menu Page - Describing Transmitter Operations

From the Home Page, press the Menu button to view the Menu page (see [Figure 3.2.12](#)). The Menu page displays icons that link to pages that control various transmitter operations.

Figure 3.2.12: Menu Page

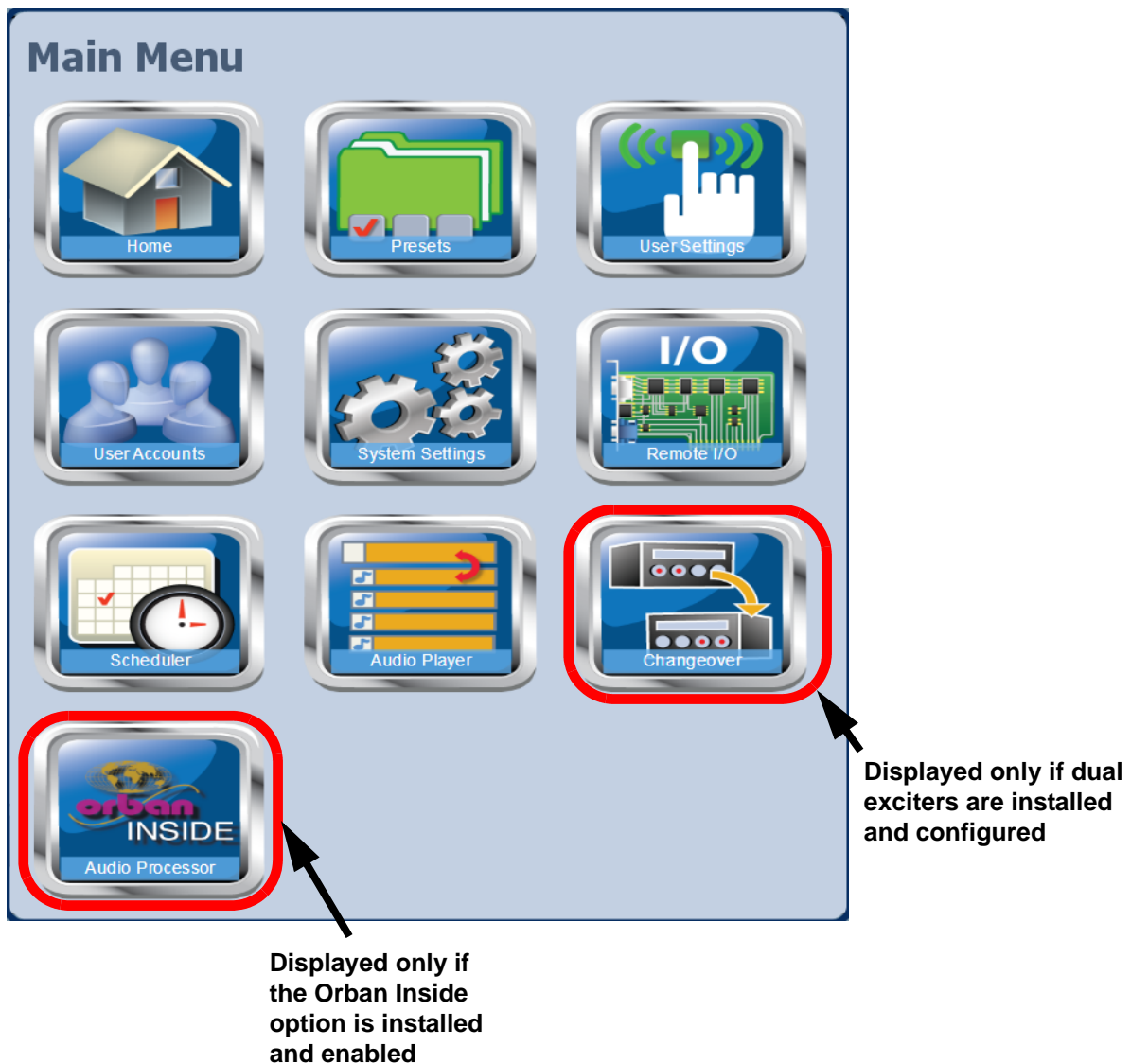

-
- ❖ Select Home to return to the home page (see [Home Page](#), on page 3.2.24).
 - ❖ Select Presets to load, edit, or save presets (see [Presets - Editing Operational Settings](#), on page 3.2.60).
 - ❖ Select User Settings to access a page that provides help with performing network configuration, email configuration, alarm notifications, SNMP configuration, capturing critical transmitter data, using and external 10 MHz source, setting the system date and time, and configuring NTP servers (see [User Settings - AUI](#), on page 3.2.137).
 - ❖ Select User Accounts to access a page that displays a list of users with access to the AUI. Depending on the user's permission level, allows editing of user accounts (see [First-Time Login](#), on page 3.2.133).
 - ❖ Select System Settings to access pages that allow rebooting of the AUI or active exciter, calibration of the exciter TCXO, upgrading of software files and calibration of audio inputs (see [System Settings](#), on page 3.2.101).
 - ❖ Select Remote I/O to access a page that allows assignation of remote digital inputs, digital outputs and analog outputs (see [Configuring Remote Inputs and Outputs](#), on page 3.2.173).
 - ❖ Select Scheduler to access a page that allows setting of daily preset schedules (see [Preset Scheduler](#), on page 3.2.187).
 - ❖ Select Audio Player to access a page that allows managing of program playlists and streams (see [Playlist Manager](#), on page 3.2.188).
 - ❖ Select Changeover to access a page that allows setting of the main exciter (if applicable), the status of the automatic exciter changeover feature and its associated changeover delay (see [Changing Exciter Transfer Settings](#), on page 3.2.134)
 - ❖ Select Audio Processor, if the Orban Inside card has been installed and enabled, to access pages that allow creation and management of Orban audio processor presets (see [Enabling and Operating the Orban Audio Processor](#), on page 3.2.196).

Viewing Transmitter Log

You can view transmitter log information using the AUI (see [Transmitter Log - Using the AUI](#)) or using the controller UI display (see [Transmitter Alarms and Log - Using the Controller UI](#), on page 3.2.36).

Transmitter Log - Using the AUI

The Logs page allows you to review the transmitter's event logs to check the operational status, historical alarms, perform troubleshooting, or identify recent changes to transmitter controls. Press **Logs** (located on bottom panel) on any AUI window to open this page (see [Figure 3.2.13 on page 3.2.28](#)).

This section includes the following topics:

- [Viewing Event Logs, on page 3.2.28](#)
- [Understanding the Log Manager Window, on page 3.2.30](#)
- [Filtering Logs, on page 3.2.31](#)
- [Copying Logs, on page 3.2.32](#)
- [Deleting Logs, on page 3.2.33](#)
- [Viewing Log Statistics, on page 3.2.34](#)
- [Viewing the Legend, on page 3.2.35](#)

Figure 3.2.13: Logs Page

Page number of displayed page

Page 1/4

Device	Event	State	Severity	Time of Event
Controller	Local/Remote	REMOTE	Warning	Fri Dec 14 2012 09:44:03 490ms
Controller	Local/Remote	LOCAL	Warning	Fri Dec 14 2012 09:43:25 090ms
Controller	Local/Remote	REMOTE	Warning	Fri Dec 14 2012 09:43:02 760ms
Controller	Local/Remote	LOCAL	Warning	Fri Dec 14 2012 09:43:00 290ms
Controller	RF On/Off	Green Checkmark	Warning	Fri Dec 14 2012 09:07:28 860ms
Controller	RF On/Off	Red Bell	Warning	Fri Dec 14 2012 09:07:12 180ms
Controller	RF On/Off	Green Checkmark	Warning	Fri Dec 14 2012 09:07:04 410ms
Controller	AC Phase Loss 1	Red Bell	Warning	Thu Dec 13 2012 15:32:23 270ms
Controller	AC Phase Loss 3	Red Bell	Warning	Thu Dec 13 2012 15:32:23 270ms
Controller	All Supplies Failed	Red Bell	Warning	Thu Dec 13 2012 15:32:23 270ms
Controller	Fan PS B High Temp	Red Bell	Warning	Thu Dec 13 2012 15:32:23 270ms
Controller	Fan PS A High Temp	Red Bell	Warning	Thu Dec 13 2012 15:32:23 270ms

first page

page-by-page

row-by-row

row-by-row

page-by-page

last page

Navigate through the table using these arrows

Viewing Event Logs

The Logs page displays a “read only” chronological table of log events under the following column headings (see Figure 3.2.13):

- Device - identifies the origin device of the alarm (e.g., Controller, Exciter, or RF Module).
- Event - identifies the alarm name.
- State - indicates whether the alarm state is active (red bell) or cleared (green checkmark) and in some cases, indicates whether the RF was turned on or off. This column will also display which control state (Local or Remote) the transmitter is in, which preset index was selected, the frequency that is set and the power level.
- Severity - indicates how seriously the alarm affects transmitter operation (see Figure 3.2.14 on page 3.2.29).
- Time of Event indicates the time and date that the event occurred.

Figure 3.2.14: Alarm Severity Legend

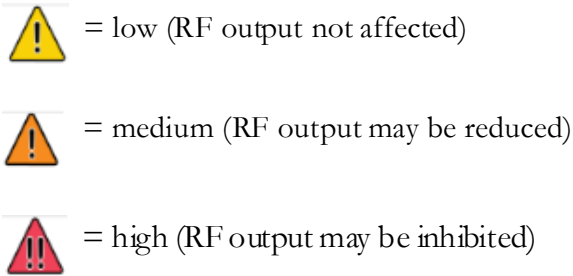

To navigate through the table, press the arrow keys on the right-side of the screen or use the scroll bar that appears when more than one page is available.

The table of log information can span over more than one page. The current page number is identified above the table on the right-side of the screen. When there are more than 100 matches in the list, a Page #/# tab will appear to allow viewing of further listings. For example, Page 1/4 means that the displayed page is one out of a possible 4 pages. Press the Page button to reveal information about the pages. The number of log matches displayed is shown below the Log Manager button (e.g., 353 Matches Sorted by Time of Event).

You can access a more detailed listing of events and resolve any alarm issues via the Log Manager window. Pressing the Log Manager button on the Logs page will provide access to this window (see [Figure 3.2.15 on page 3.2.30](#)).

Refer to the GV5/GV3.5 Troubleshooting Manual to cross-reference the alarm name to possible causes and troubleshooting tips.

Understanding the Log Manager Window

The Log Manager window contains the functions that edit the logs listed in the Logs page. Press the Log Manager button to open a configurable window with the following display options identified by tabs across the top of the screen (see [Figure 3.2.15](#)):

- Filter Logs: Press to determine filter parameters by date and frequency.
- Copy Logs: Press to copy the selected logs (remote view only).
- Delete: Press to remove all selected logged events.
- Statistics: Press to display detailed information about an event(s).
- Legend: The Legend tab opens a "read only" display of alarm symbols to help you interpret the ones listed in the Logs page or in the Statistics window (see [Figure 3.2.19](#) on page 3.2.34).

Each of these tabs, opens a secondary window or changes the active window options to suit the tab function.

Figure 3.2.15: Log Manager Window

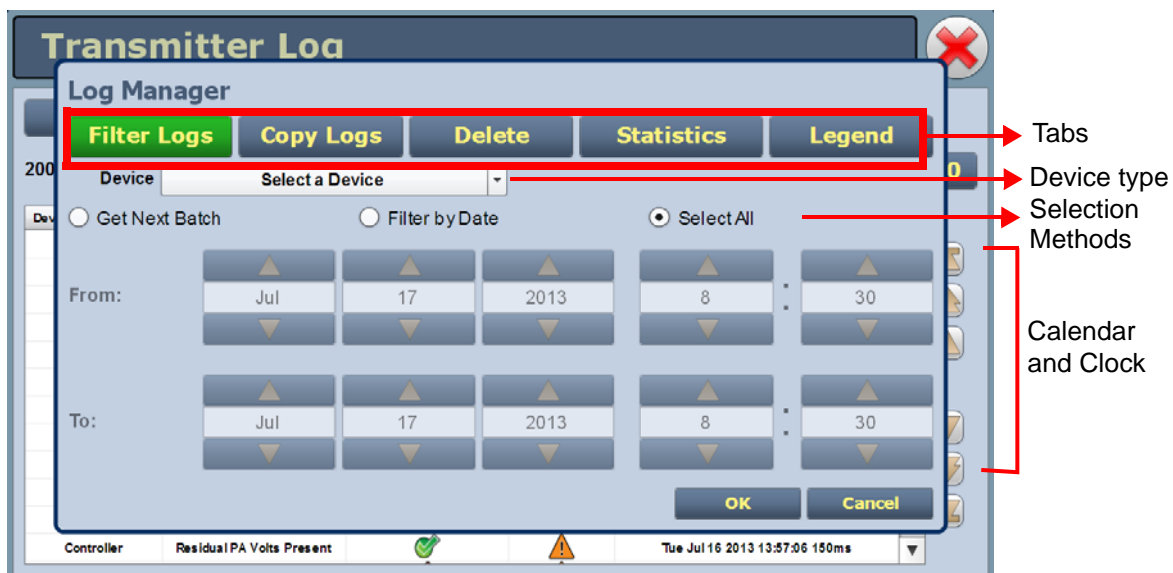

Filtering Logs

You can filter transmitter events based on their origin or date by pressing the **Filter Logs** button in the Log Manager (see [Figure 3.2.16 on page 3.2.31](#)).

Press the **Select a Device** drop-down arrow, and select the desired device type to filter events based on the type selected. Press the **OK** button or the **Cancel** button when done.

- ❖ No selection - displays all transmitter events (shown as **Select a Device**)
- ❖ Controller - displays controller events only
- ❖ Exciter A or B - displays applicable exciter events only
- ❖ Rack # - displays applicable Rack # events only
- ❖ RF Module # - displays applicable RF Module # events only

Activate a log mode option by selecting the adjacent radio button:

- ❖ Get Next Batch - allows users to see log events in batches of 2000
- ❖ Filter by Date - activates the calendar portion of the screen and allows users to select a date range
- ❖ Select All - selects all logs for display

Click the **Cancel** button to close this window and discard changes.

Figure 3.2.16: Log Manager - Filter Logs

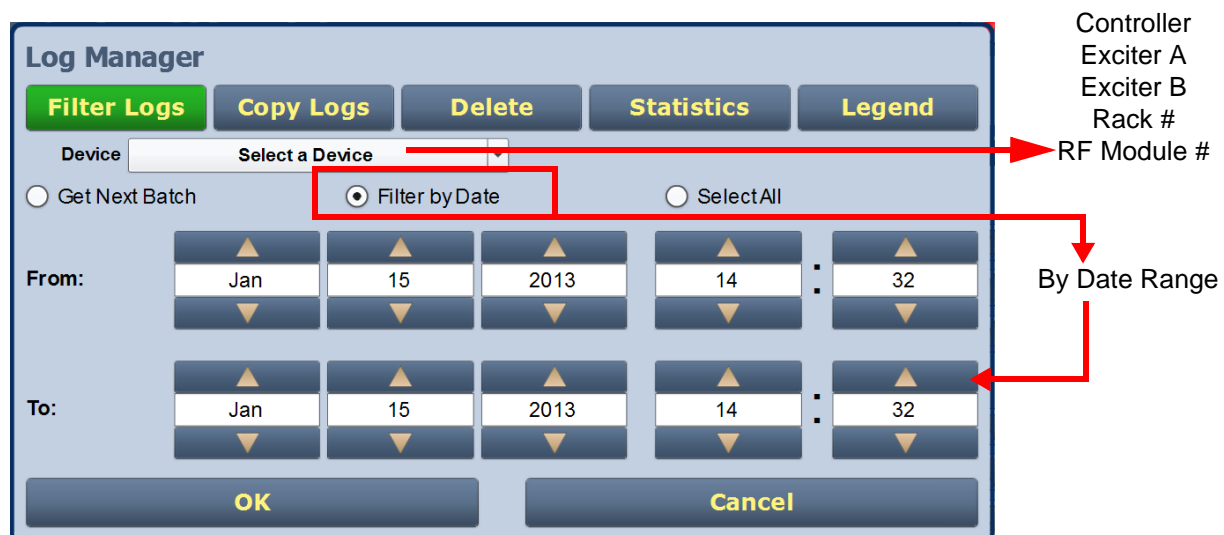

Copying Logs

Using the remote AUI only, you can create a copy of all the logs in the selected list (copied to the remote user's computer clipboard) by pressing the Copy Logs button in the Log Manager (see [Figure 3.2.17](#)). You can paste the tab-delimited text copy of the logs into a text editing program such as Word, Excel, Notepad, etc. Press OK or Cancel to close this window and return to the Transmitter Log.

Figure 3.2.17: Log Manager - Copy Logs

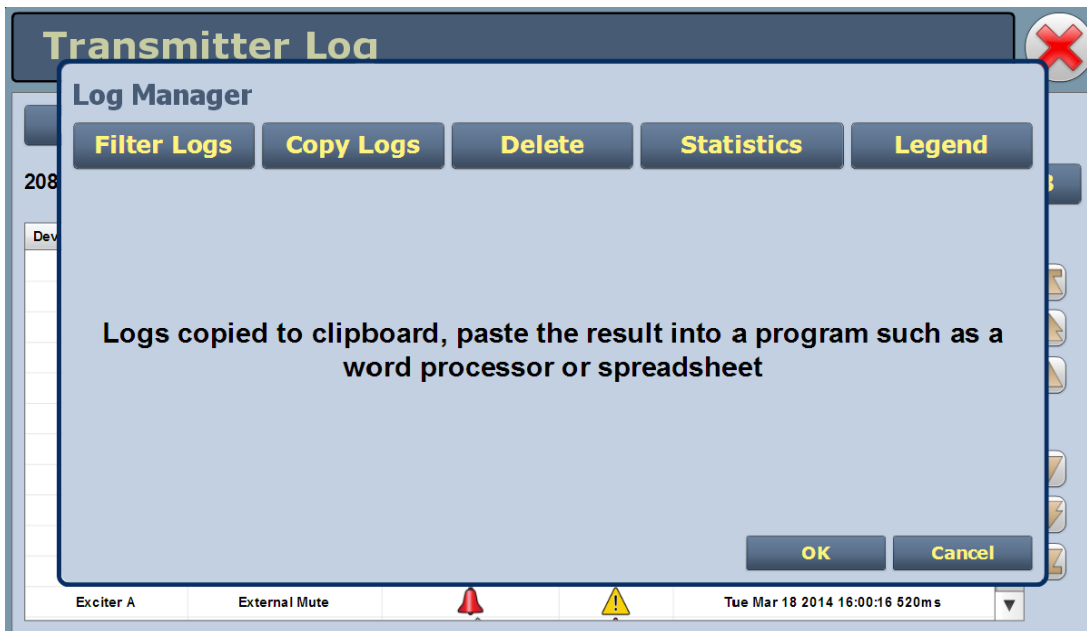

Deleting Logs

You can delete all events or a selection of events by pressing the Delete button in the Log Manager (see [Figure 3.2.18](#)).

- Delete by date - activates the calendar and clock (24-hour clock) where users can press the arrows to establish a date and time. Log events older than this date will be removed from the events list.
- Delete All - removes all the logs in the list.
- Press OK to accept the configuration or press Cancel button to close this window and return to the Transmitter Log.

Figure 3.2.18: Log Manager - Delete Logs

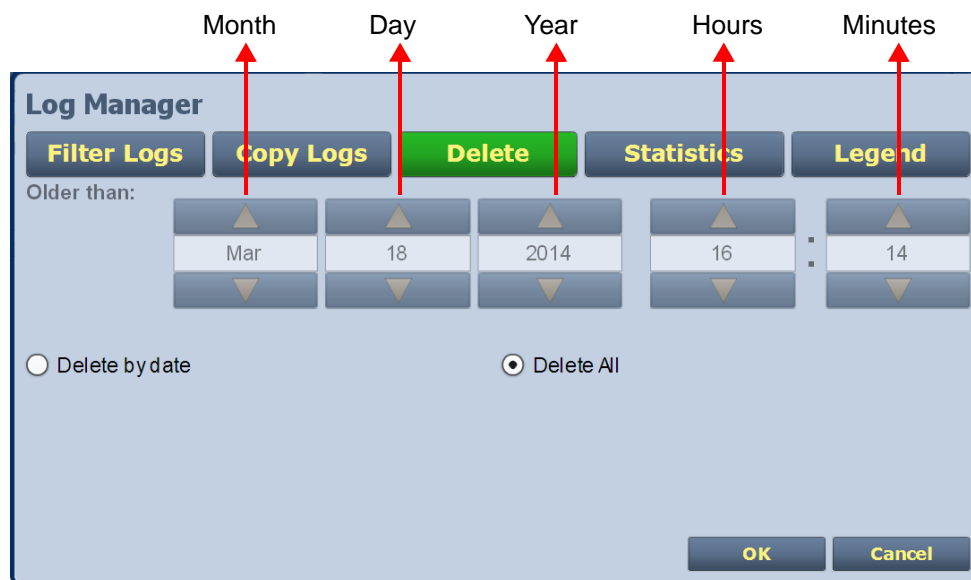

Viewing Log Statistics

You can view statistical information on the events being displayed by pressing the Statistics button in the log manager (see [Figure 3.2.19](#)).

NOTE: *Only events subject to the filtering parameters are displayed on the Statistics screen.*

The Statistics screen displays the events that occurred within the filtered period as well as the time and date of the earliest and latest event occurrence for each. You can move through the list using the scroll bar (if applicable) or the up and down arrow buttons to the right of the scroll bar. Press OK or Cancel to close this window. The columns in the display indicate specific information about the events:

- Device - refers to the device (Controller, Exciter, Rack, RF Module) associated with the alarm.
- Event - describes the alarm (e.g., Local/Remote switch)
- Severity - identifies the seriousness of the alarm (see [Viewing the Legend](#), on page 3.2.35).
- # Events - reveals the number of occurrences for that event during the filtered period.
- Earliest - refers to the first time of an alarm event, within the filtered period.
- Latest - refers to the latest time of an alarm event, within the filtered period. If an alarm has only one occurrence (i.e., # Events column is 1), then the time in the "Earliest" column will be the same as the time in the "Latest" column. If an alarm has more than one occurrence (e.g., # Events column is 4), then the "Earliest" column reveals the time of the first alarm (back in time), while the "Latest" column reveals the time of the last alarm (closest to the present).

Figure 3.2.19: Log Manager - Statistics

Selects item at top of current page
 Selects next higher page items
 Scrolls up one item
 Scrolls down one item
 Selects next lower page items
 Selects item at bottom of current page

Device	Event	Sever...	# Eve...	Earliest	Latest
Controller	Local/Remote	⚠	6	16:04:34 Mon Mar 17 2014	15:49:21 Tue Mar 18 2014
Controller	RF On/Off	⚠	17	15:53:12 Mon Mar 17 2014	16:12:56 Tue Mar 18 2014
Controller	External Interlock Op	⚠	12	15:53:07 Mon Mar 17 2014	16:12:46 Tue Mar 18 2014
Controller	Low RF Drive	⚠	2	15:39:23 Tue Mar 18 2014	15:39:32 Tue Mar 18 2014
Controller	Missing Preset	⚠	3	11:20:16 Tue Mar 18 2014	11:20:37 Tue Mar 18 2014
Controller	Entered Firmware Up	⚠	2	11:15:17 Tue Mar 18 2014	11:15:27 Tue Mar 18 2014
Controller	Rebooted Exciter	⚠	7	10:57:42 Tue Mar 18 2014	16:00:12 Tue Mar 18 2014
Controller	Reboot Required	⚠	1	11:20:16 Tue Mar 18 2014	11:20:16 Tue Mar 18 2014
Controller	Exciter A Offline	⚠	7	10:57:46 Tue Mar 18 2014	16:00:16 Tue Mar 18 2014
Controller	Mode/Frequency Mis	⚠	12	16:05:42 Mon Mar 17 2014	16:00:10 Tue Mar 18 2014
Controller	Chassis in Break	⚠	11	10:57:49 Tue Mar 18 2014	16:07:22 Tue Mar 18 2014

Viewing the Legend

Press the Legend button in the Log Manager (see [Figure 3.2.20](#)) to display a legend that describes the symbols shown in the State and Severity columns of the Logs page. Press OK or Cancel to close this window and return to the Transmitter Log page.

Figure 3.2.20: Log Manager - Legend



Transmitter Alarms and Log - Using the Controller UI

When you select View Status -> View Alarms or View Status -> View Log from the Main Menu (see [Figure 3.2.21](#)), you can view various active or logged events, respectively, of the GV5/GV3.5. These parameters are likely displayed on multiple pages and require that you scroll to view all of them.

NOTE: This screen is for viewing purposes only and does not offer the same level of analytical features as the AUI's Logs page (see [Figure 3.2.13 on page 3.2.28](#)).

Figure 3.2.21: View Alarms and View Logs Screens

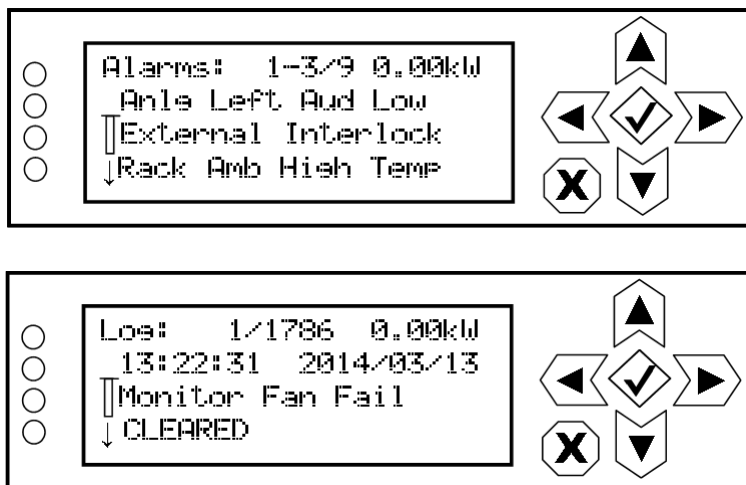

The View Alarms screen displays only alarms that are currently active. Older alarms that have cleared may still be present in the View Log screen.

Use the up and down buttons to scroll through the list of alarms or logged events.

Refer to the GV5/GV3.5 Troubleshooting Manual to cross-reference the alarm name to possible causes and troubleshooting tips.

When you select Clear Log from the View Status menu, you will delete all logged events.

Use the Reset Alarms command in the front panel UI's Main Menu -> Reset Alarms screen to attempt to clear any latching alarms that are holding the transmitter in an "off-air" state. If the offending alarm has cleared, the transmitter should resume operation. See [Resetting Alarms, on page 3.2.98](#).

Viewing Tool Menu Panels

The center area of the AUI's Home page displays up to four panels of instrument information. Users can choose the panels for display from 11 possible instrument panels (depending on purchased options).

This section include the following topics:

- Describing Instrument Panel Options, on page 3.2.38
- Viewing Instrument Panels, on page 3.2.39
- Instrument Panel Procedures, on page 3.2.39
- Available Instrument Panels, on page 3.2.41

Figure 3.2.22: Tool Menus on Home page

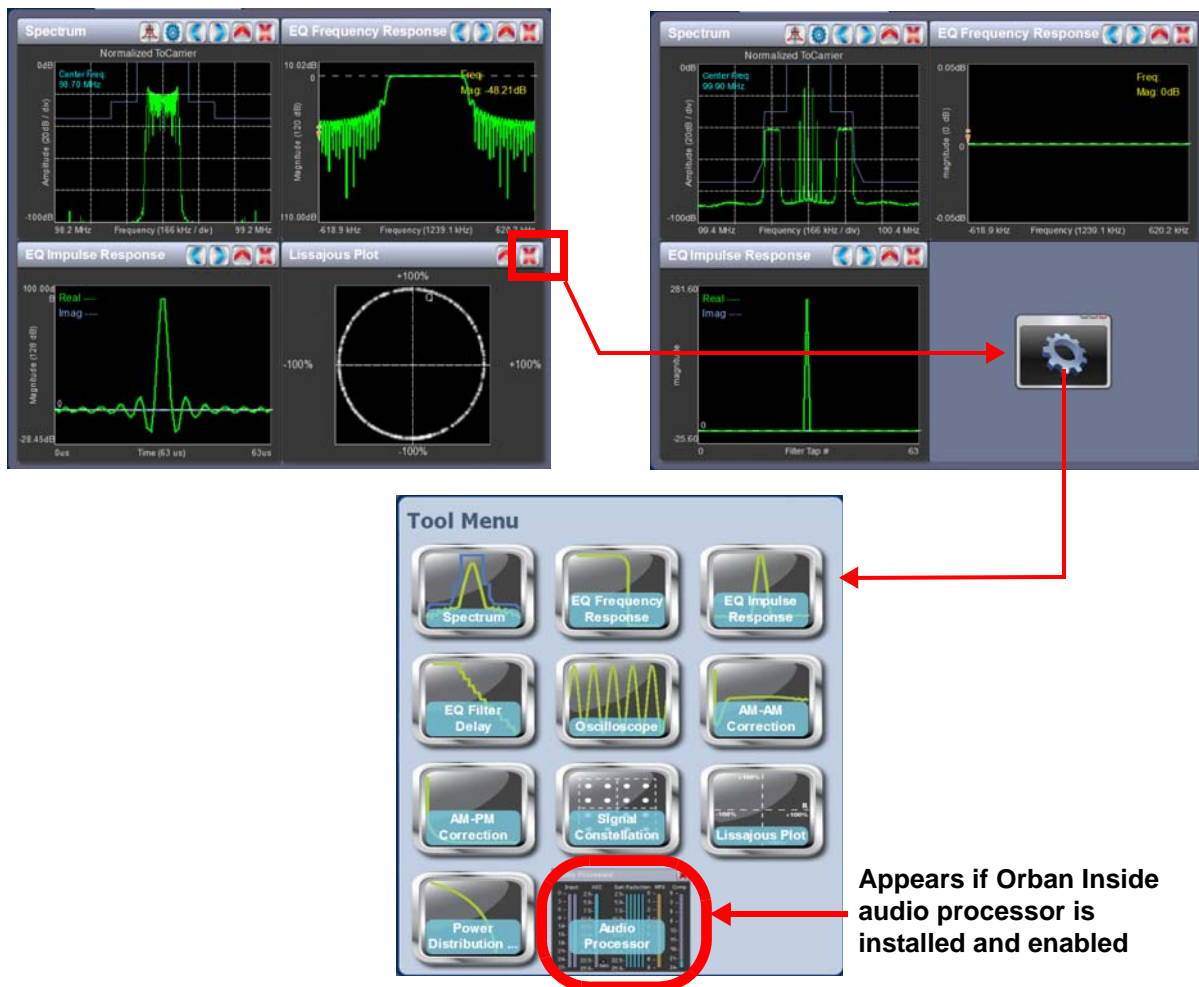

To view the Tool Menu options (see [Figure 3.2.22 on page 3.2.37](#)), close an existing panel by pressing X in the upper, right corner and then press the icon in the blank space. Select an icon to display that panel. See [Table 3.2.3](#) for a description of each tool menu panel.

Describing Instrument Panel Options

Table 3.2.3: Tool Menu Panels

TOOL MENU	DESCRIPTION	REFERENCE
Spectrum	Displays a spectrum analyzer, capable of monitoring the transmitter's RF output and various RF sections of the exciter or an audio spectrum analyzer that displays the composite baseband signal.	See page 3.2.43
EQ Frequency Response	Displays the frequency response of the modulator's EQ filter.	See page 3.2.43
EQ Impulse Response	Displays the impulse response of the modulator's EQ filter.	See page 3.2.44
EQ Filter Delay	Displays the delay of the modulator's EQ filter across its bandwidth	See page 3.2.45
Oscilloscope	Displays an oscilloscope, capable of monitoring various audio inputs and the precorrection forward/reverse signal.	See page 3.2.43
AM-AM Correction	Displays the amplitude compensation being applied to the magnitude signal.	See page 3.2.48
AM-PM Correction	Displays the phase compensation being applied to the phase signal.	See page 3.2.49
Signal Constellation	Displays the phase and amplitude of the symbols being modulated within an OFDM sub-carrier as dots on a cartesian graph. Also displays timing, MER and data carrier information.	See page 3.2.50
Lissajous Plot	Displays a Lissajous figure that represents the relationship between the two applicable channels (either L and R or I and Q).	See page 3.2.51
Power Distribution	Displays a CCDF plot that indicates the probability of exceeding a given power level, based on the average power level. Aids in determining peak power capability.	See page 3.2.52
Audio Processor (optional)	Appears only when Orban Inside audio processor is installed and enabled. Displays various audio processor meters that indicate levels for inputs, AGC, gain reduction, multiplex (MPX) power and composite. Refer to Enabling and Operating the Orban Audio Processor on page 3.2.196 and the Orban Optimod 5500 manual for detailed information on these meters.	See page 3.2.206

Viewing Instrument Panels

Each instrument panel has a menu bar that may be different from other panels (see [Figure 3.2.23](#)).

Figure 3.2.23: Instrument Panel Menus

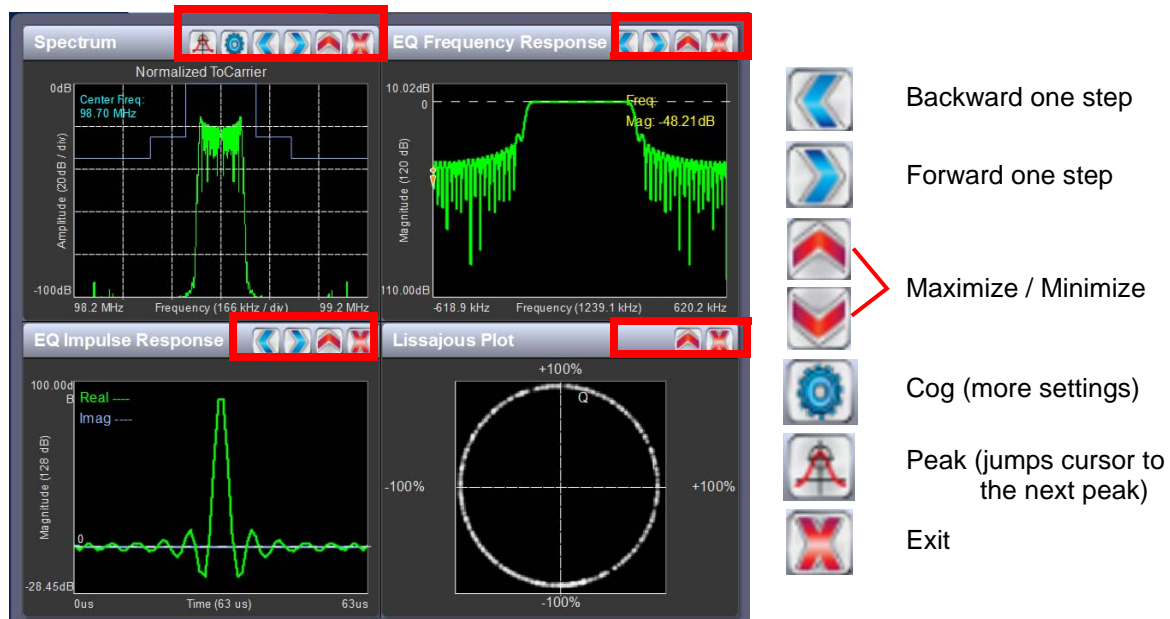

Each panel has a tool bar at the top of the display

Instrument Panel Procedures

Procedure to view instrument readings on the panel:

- To display a cursor in the panel, click or touch the screen where you want the cursor (see [Figure 3.2.24](#) on page 3.2.40). The cursor position is noted in the upper, right-hand corner of the panel (e.g., frequency and amplitude for the spectrum analyzer). Select other areas of the instrument to provide a coarse adjustment of the cursor position.
- To make fine adjustments, use the backward and forward buttons (see [Figure 3.2.23](#)).
- To enlarge/reduce the instrument panel, use the maximize/minimize buttons. Some instrument displays show more information when maximized (e.g., EQ Impulse Response (see [Figure 3.2.25](#) on page 3.2.40).
- To display additional settings in the Spectrum Analyzer or Oscilloscope panel, select the "cog" button (see [Figure 3.2.23](#)). For the spectrum analyzer tool, this shows the resolution bandwidth, span, averaging rate and the actual measurement source (transmitter output, audio analyzer, etc.) that is being displayed. Select the "peak" button (see [Figure 3.2.23](#)) to place the cursor on the next successive peak in the spectrum.

Figure 3.2.24: Instrument Cursor Manipulation

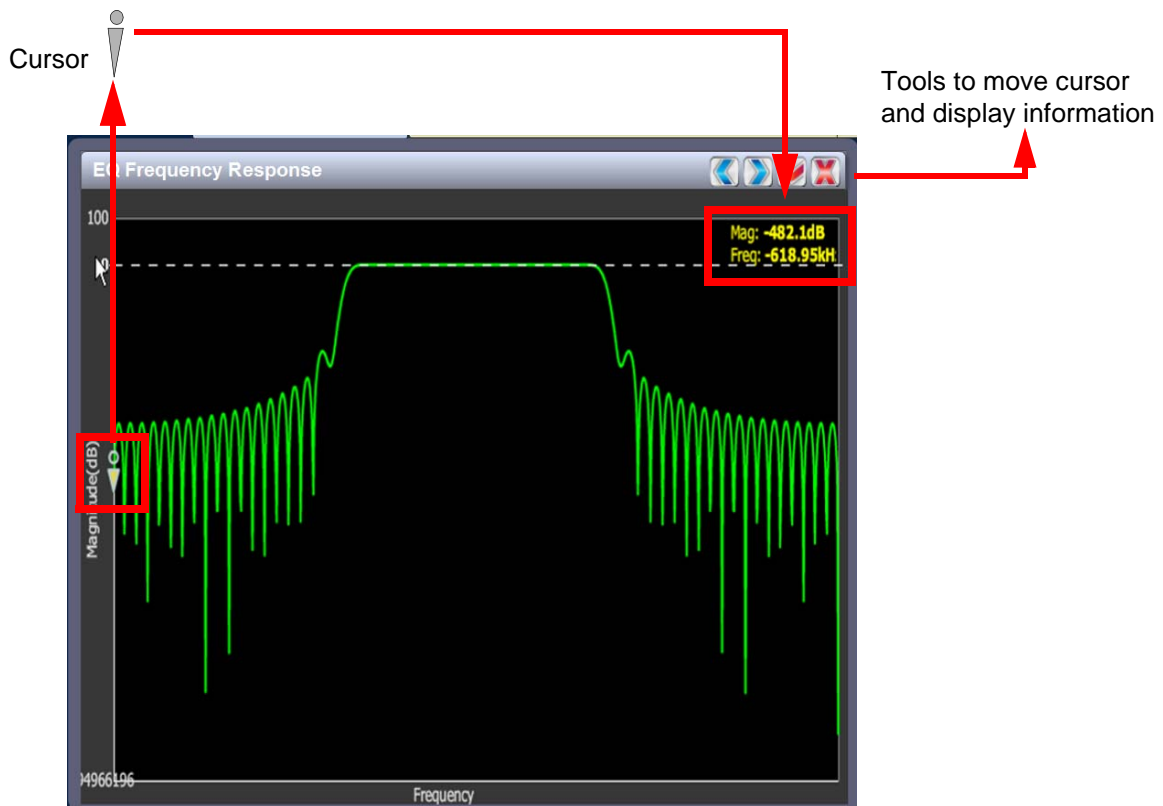
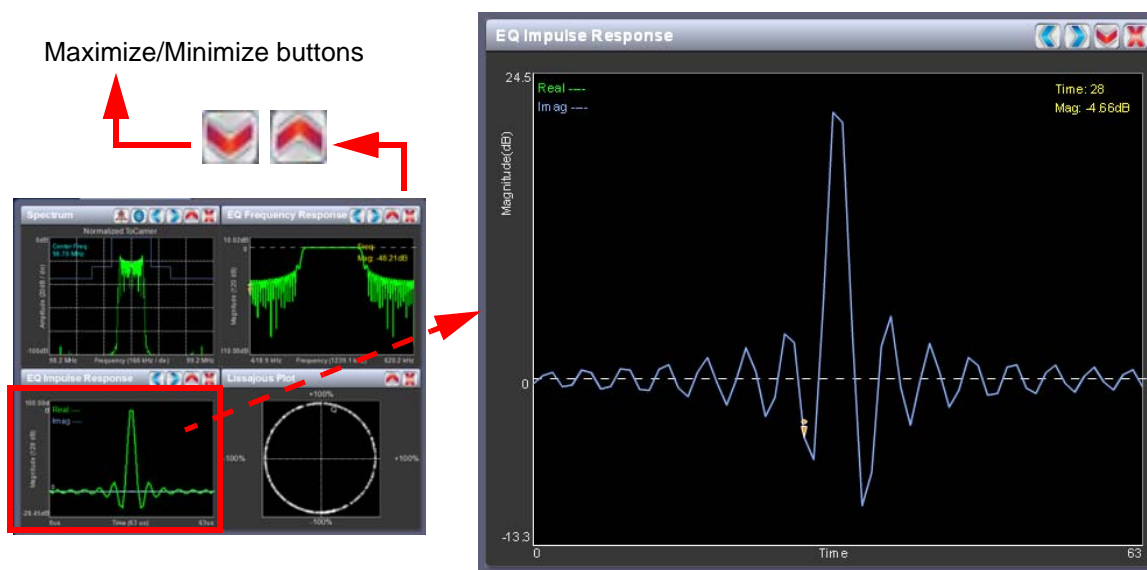

Figure 3.2.25: Instrument Panel - Expansion Example



Available Instrument Panels

Spectrum Analyzer

See [Figure 3.2.26](#). The carrier level is normalized to its unmodulated carrier level at 0 dB. The graph center is always at the carrier frequency, as defined by the active preset's Frequency value.

Masks are shown based on transmission mode and are defined by the latest versions of the following standards:

- IBOC: NRSC-5
- European Standard: ETSI EN 302 018-2
- FCC CFR 47, Part 73.317 and IC BETS-6e

NOTE: While very accurate, the spectrum analyzer may display artifacts (spurs) as some operating carrier frequencies that are a function of the analyzer and are not actually present on the output of the transmitter. If these spurious emissions are observed on the spectrum analyzer, Nautel recommends that a calibrated, external spectrum analyzer be used to verify the presence of spurs.

Click or touch on the panel to display a cursor in the approximate area. The cursor position (frequency and amplitude) is noted in the upper, right-hand corner of the panel. Select other areas of this instrument panel to provide a coarse adjustment of the cursor position.

Figure 3.2.26: Spectrum Analyzer

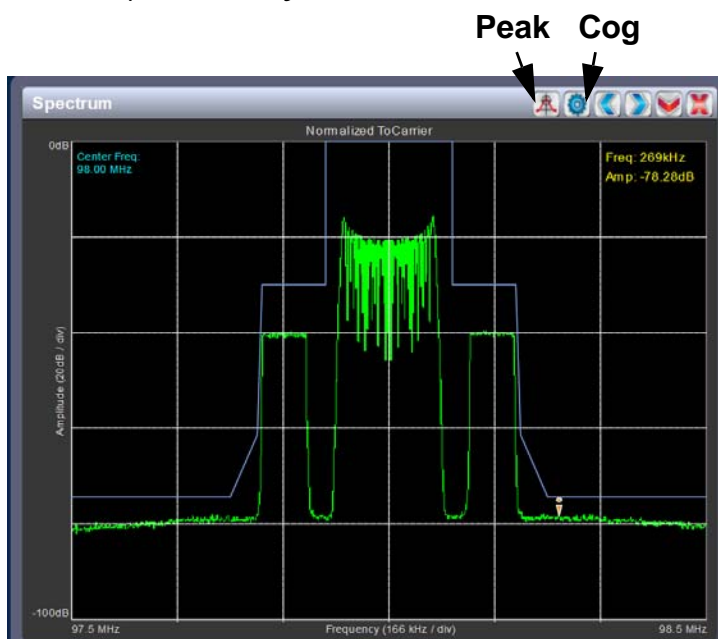

Use the left and right buttons to make fine adjustments.

Use the maximize or minimize buttons as required.

Use the "peak" button to place the cursor on the next successive peak (moving left to right) in the spectrum.

Use the "cog" button to gain access to spectrum settings (see [Figure 3.2.27](#)) such as:

- Resolution Bandwidth: determines the FFT bin size or the smallest frequency that can be resolved. Allowable range is 75 - 10,000 Hz. Default setting is 1000 Hz.
- Span: determines the start and stop frequencies of the analyzer with the carrier frequency always at the center. Allowable range is 10 - 1200 kHz. Default setting is 1000 kHz.
- Averages: determines the number of averages that the analyzer performs per sweep. Press the Clear Averaging button to restart the averaging process. Allowable range is 0 - 100. Default setting is 19.
- Measurement Source: determines the source of the spectrum plot (transmitter output, audio analyzer, etc.) that is being displayed. Selecting TX Output uses the exciter's RF sample feedback signal to display the RF output spectrum. Selecting Internal (Post EQ) displays the signal that will be produced by the exciter. Selecting Internal (FM) uses the exciter's RF signal, before being equalized (if applicable). FM spectrum analyzer bandwidth is defaulted to 1 MHz, but can be increased to 1.2 MHz. Selecting MPX bandwidth displays the entire composite baseband signal (100 kHz wide).

Figure 3.2.27: Spectrum Settings

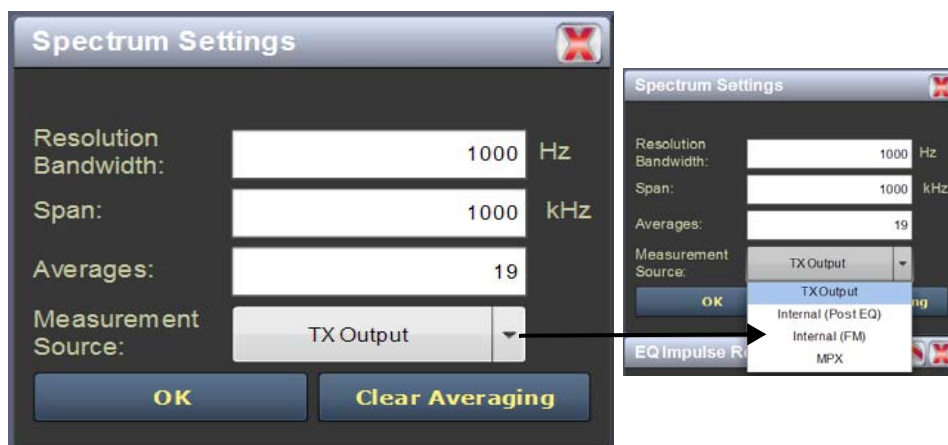

Equalizer Screens

The GV5/GV3.5's exciter includes a fixed equalizer to optimize audio performance. There are three menus available in the tool panel - EQ Frequency, EQ Impulse Response and EQ Filter Delay. Coefficients are selected based on your channel frequency. All frequencies shown are relative to the channel frequency.

Figure 3.2.28: EQ Frequency Response

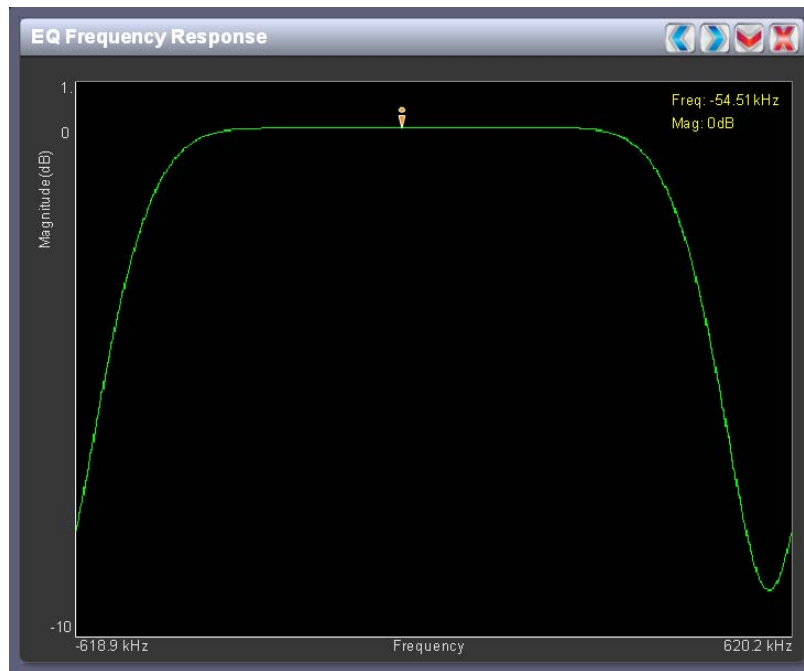

EQ Frequency Response

See [Figure 3.2.28](#). This panel displays the frequency response of the exciter's EQ filter. The panel displays the gain of the filter with respect to the magnitude and frequency of the modulating signal. A dashed line is displayed at the 0 dB level.

This tool is useful for installations featuring filter coefficients loaded to compensate for a channel combiner response.

Click or touch on the panel to display a cursor in the approximate area. The cursor position (magnitude and amplitude) is noted in the upper, right-hand corner of the panel. Select other areas of the panel to provide a coarse adjustment of the cursor position.

Use the left and right buttons to make fine adjustments to the cursor position.

Use the up or down button to maximize (if it was minimized) or minimize (if it was maximized) the panel size.

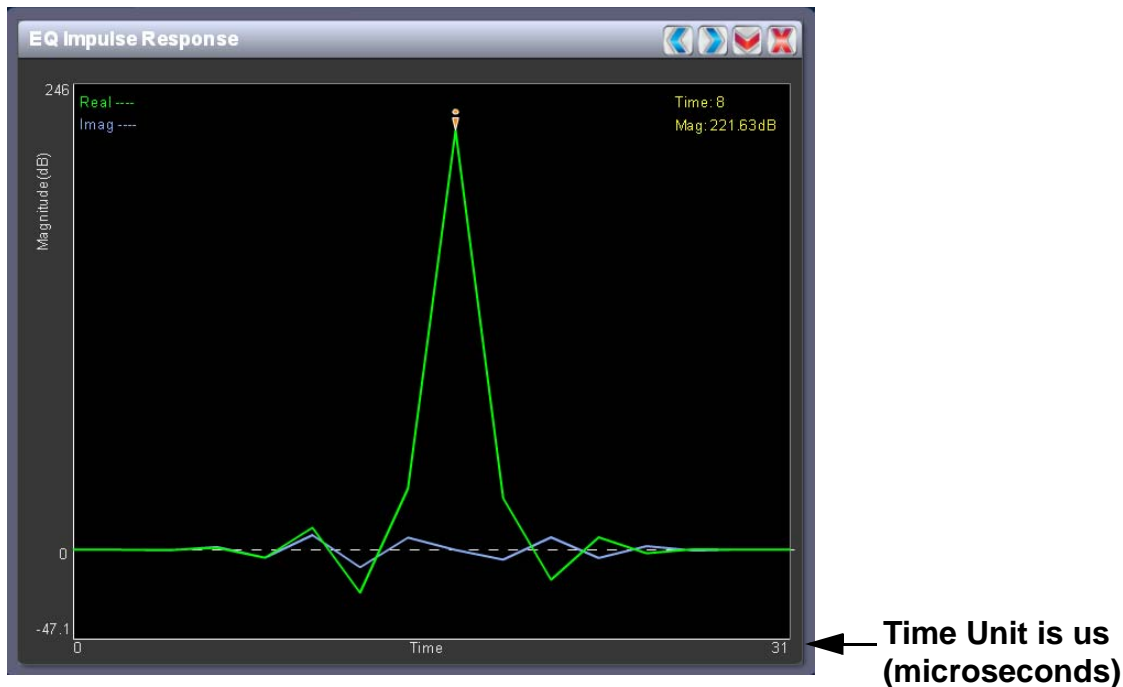
Figure 3.2.29: EQ Impulse Response

EQ Impulse Response

See [Figure 3.2.29](#). This panel displays the impulse response of the modulator's EQ filter in the time domain. This is a static display tool so the screen image is not fluid and will not change.

Click or touch on the panel to display a cursor in the approximate area. The cursor position (time and magnitude) is noted in the upper, right-hand corner of the panel. Select other areas of the panel to provide a coarse adjustment of the cursor position.

Use the left and right buttons to make fine adjustments to the cursor position.

Use the up or down button to maximize (if it was minimized) or minimize (if it was maximized) the panel size.

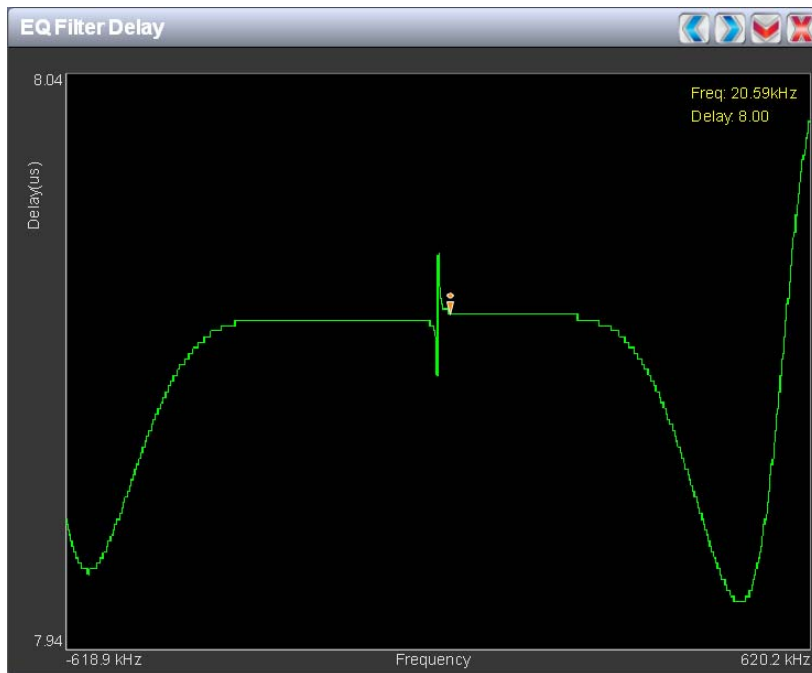
Figure 3.2.30: EQ Filter Delay

EQ Filter Delay

See [Figure 3.2.30](#). This panel displays the delay of the modulator's EQ filter across its bandwidth.

Click or touch on the panel to display a cursor in the approximate area. The cursor position (frequency and delay) is noted in the upper, right-hand corner of the panel. Select other areas of the panel to provide a coarse adjustment of the cursor position.

Use the left and right buttons to make fine adjustments to the cursor position.

Use the up or down button to maximize (if it was minimized) or minimize (if it was maximized) the panel size.

Oscilloscope

See [Figure 3.2.31](#). The GV5/GV3.5's exciter includes an oscilloscope to allow monitoring of audio input parameters. The oscilloscope displays a real-time waveform for the selected audio input (e.g., L/R audio input). The audio input(s) being monitored is displayed in the upper, left-hand corner of the panel (e.g., R in green, L in blue for L/R audio input.) The limits for the amplitude axis (volts/division) and time axis (microseconds/division) are preset in software for each selected input and cannot be adjusted. The following button controls are available:

Figure 3.2.31: Oscilloscope (Left/Right Audio input shown)

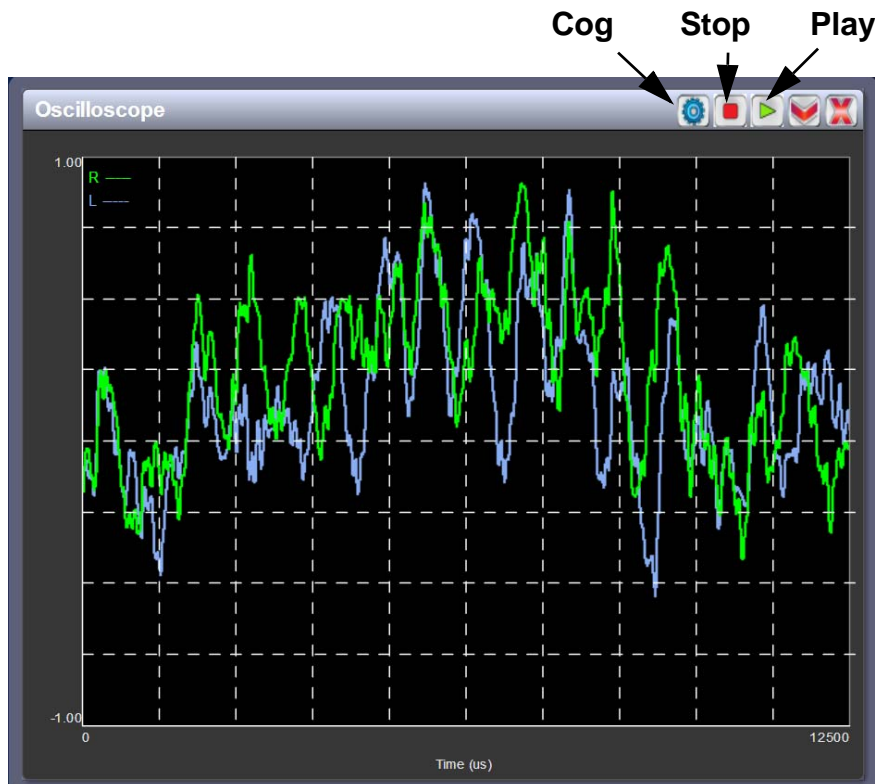

Use the "cog" button to gain access to the measurement source setting (see [Figure 3.2.32](#) on page 3.2.47). Use the drop-arrow to select from the the various options - Precorrection Forward/Reverse (shows reverse and forward sample signals), MPX Audio, Left/Right Audio (shows left and right signals) or Audio I/Q (shows I and Q signals).

NOTE: If the controller UI's test signal generator is enabled, the test signal may appear on certain oscilloscope displays. To view the actual audio input's signal, disable the test signal generator (see [Configure Test Signal Generator](#), on page 3.2.168).

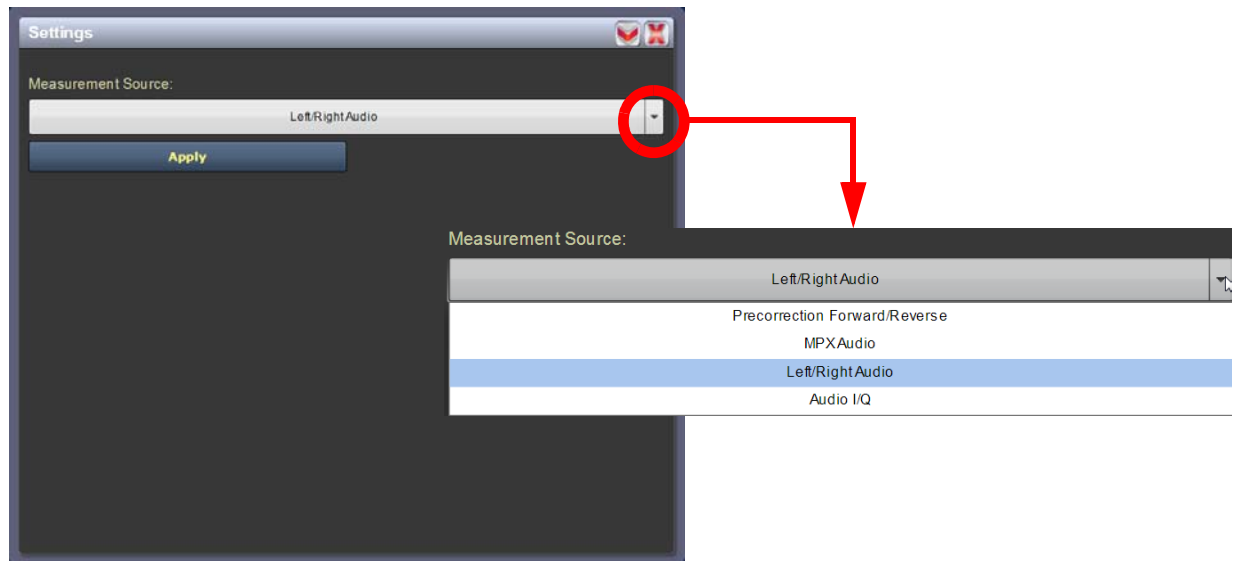
Figure 3.2.32: Measurement Source Settings

Use the 'stop' button to display a snapshot of the waveform for analysis, printing, etc.

Use the 'play' button to resume the live, real-time display of the waveform.

Use the up or down button to maximize (if it was minimized) or minimize (if it was maximized) the panel size.

AM-AM and AM-PM Correction Screens

When the transmitter is operating with digital carriers, the exciter linearizes the transmitter's RF drive signal by performing adaptive pre-correction. There are two correction parameters - AM-AM Correction (see [Figure 3.2.33](#)) and AM-PM Correction (see [Figure 3.2.34 on page 3.2.49](#)), which can be viewed as an instrument panel.

Figure 3.2.33: AM-AM Correction

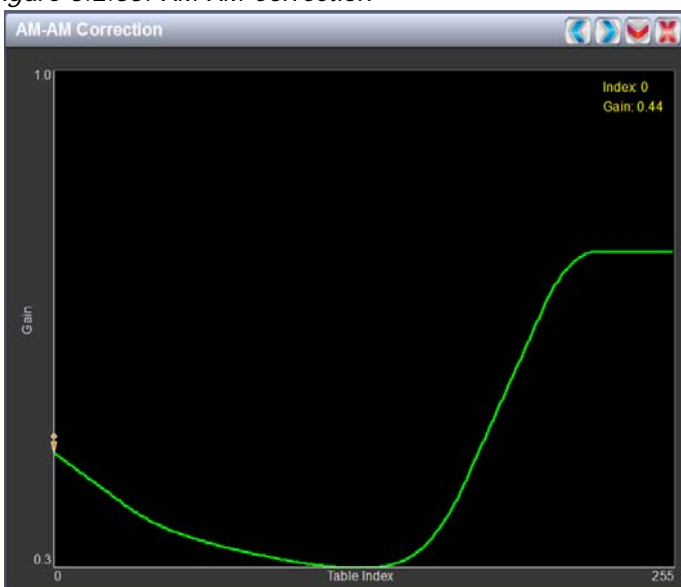

AM-AM Correction

This panel displays the amplitude correction being applied to the RF drive signal in order to compensate for the transmitter amplitude (gain) response, which is non-linear. The x-axis represents the signal amplitude and the y-axis represents the gain correction applied for a given amplitude value. A look up table (LUT) index value of 0 represents low transmitter output power (RF drive). A LUT index value of 255 represents the maximum transmitter output power (RF drive).

The LUT curve can show that at low transmitter output power, more RF drive power is required to correct for low final stage amplifier gain - the curve sharply increases as it drops to 0 table value. (This low gain can also be overcome using additional bias, however pre-correction is more efficient.) Equally, the curve could also increase sharply at the top end of the table, suggesting that high RF drive power (gain) is required to connect for low gain at final stage amplifiers (PA compression peak limiting). It is technically the inverse of the transmitter's power amplifier gain response.

Touch on the panel to display a cursor in the approximate area. The cursor position (Gain and LUT index) is noted in the upper, right-hand corner of the panel. Touch in other areas of this instrument panel to provide a coarse adjustment of the cursor position. Use the left/right fine adjustment buttons and the maximize/minimize buttons as required.

Figure 3.2.34: AM-PM Correction

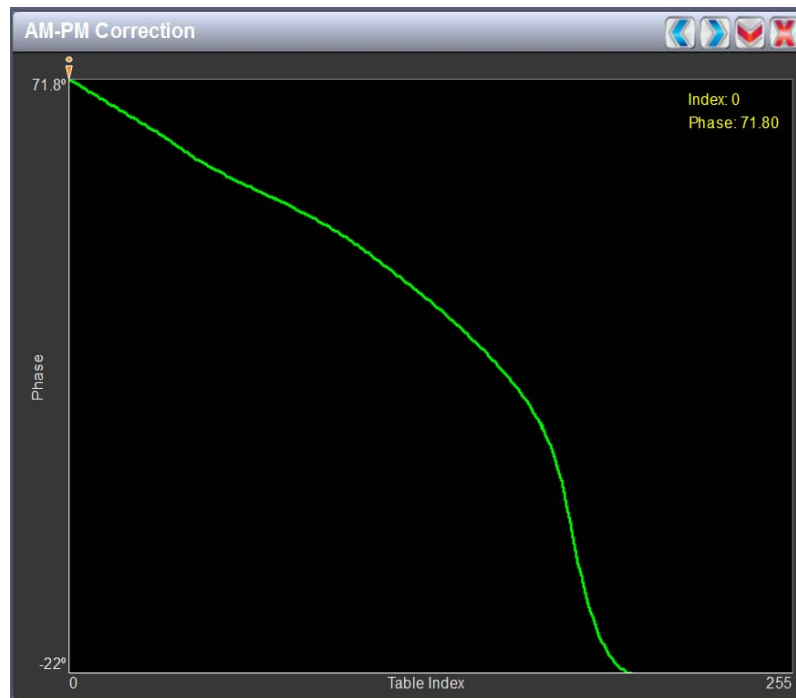

AM-PM Correction

This panel displays the phase correction being applied to the RF drive signal in order to compensate for the transmitter's (exciter +PA stage) phase non-linearity versus the output power. For example, in [Figure 3.2.34](#) the transmitter output power is low, so the curve in the plot shows positive phase correction. Inversely, a negative phase correction will be displayed in the plot given high output power levels. This correction is represented on the plot via the x-axis (table index value of between 0-255). The y-axis represents the phase shift correction applied for a given amplitude value.

Touch on the panel to display a cursor in the approximate area. The cursor position (phase and LUT index) is noted in the upper, right-hand corner of the panel. Touch in other areas of this instrument panel to provide a coarse adjustment of the cursor position.

Use the left and right buttons as fine adjustments.

Use the maximize or minimize buttons as required.

Figure 3.2.35: Signal Constellation

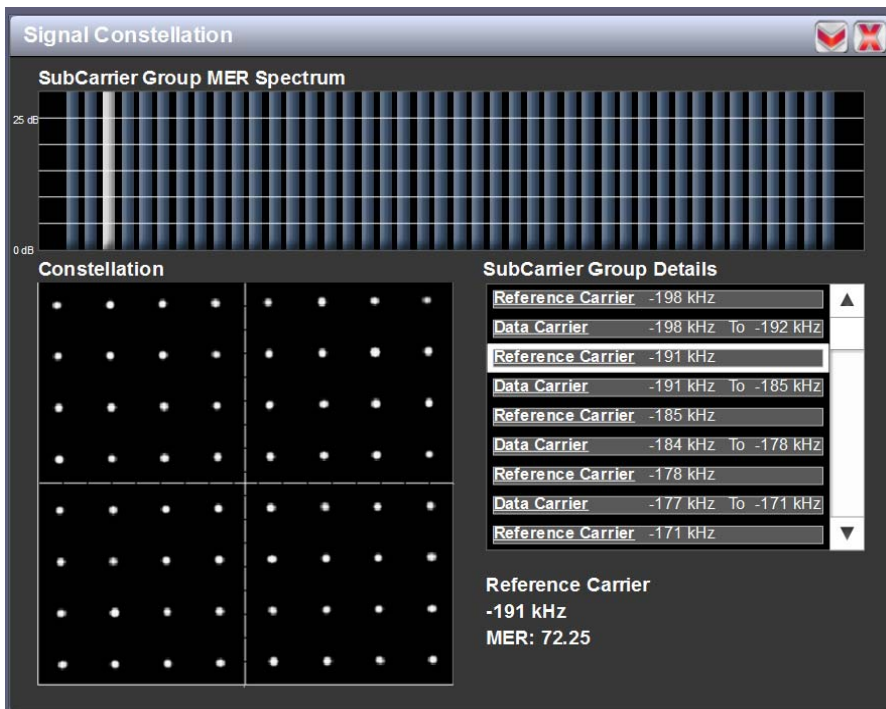

Signal Constellation

See [Figure 3.2.35](#). The exciter constantly measures the transmitter signal and performs basic demodulation of the digital carriers. The Signal Constellation panel displays the phase and amplitude of the symbols being modulated within an OFDM sub-carrier as dots on a cartesian graph. There are separate screens for each sub-carrier. Typically, the dots will be grouped together around the ideal data points. When the transmitter is on, the signal constellation display is representative of the transmitter output. When the transmitter is off, the display is representative of the forward path that will be transmitted.

Sub-carrier group information is shown in the lower, right section of the screen. Displayed information includes the sub-carrier group name, the bandwidth that the selected carrier group occupies and the modulation error ratio (MER) for the selected carrier group. MER quantifies the performance of the transmitted digital signal as the ratio between the RMS power of the ideal signal and the RMS power of the received signal's error vector. A higher MER value is characteristic of a smaller error, and therefore a higher quality signal. There is a NRSC minimum requirement of a MER value of no less than 14 dB.

Use the scroll bar to select a higher or lower sub-carrier for viewing. Some sub-carriers are for timing and synchronization. Others are modulated with data/content. Use the maximize or minimize buttons as required.

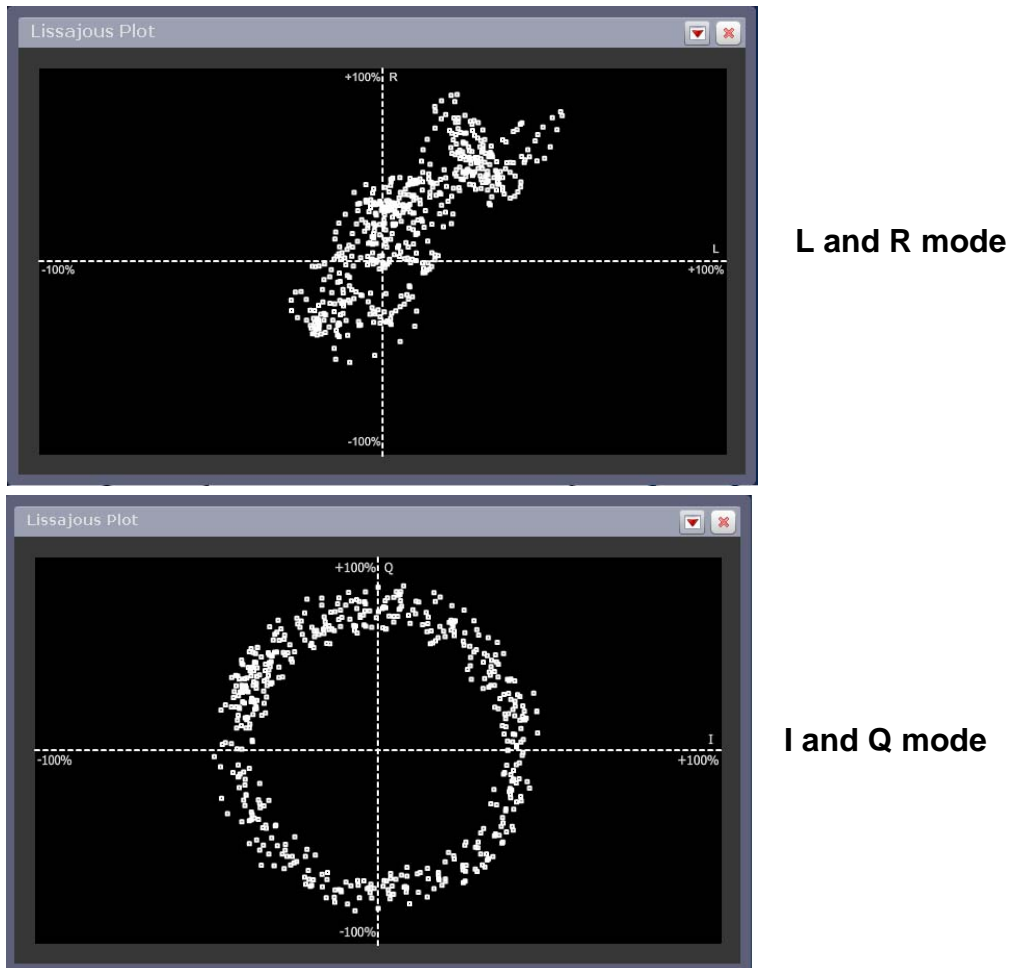
Figure 3.2.36: Lissajous Plots

Lissajous Plot

See [Figure 3.2.36](#). This panel displays a Lissajous plot that represents either left and right audio content or a representation of the FM modulated signal (I and Q). I and Q will be automatically selected when using MPX as the main audio source. Left and right audio content is displayed for all other audio sources.

The plot consists of a group of sequential samples to allow signal analysis. In L and R mode, the L+R portion of the signal tends to dominate the plot, resulting in the majority of samples appearing in the lower, left and upper, right quadrants. In I and Q mode, signals that are of equal frequency and 90 degrees out-of-phase result in a circular display.

Use the maximize or minimize buttons as required.

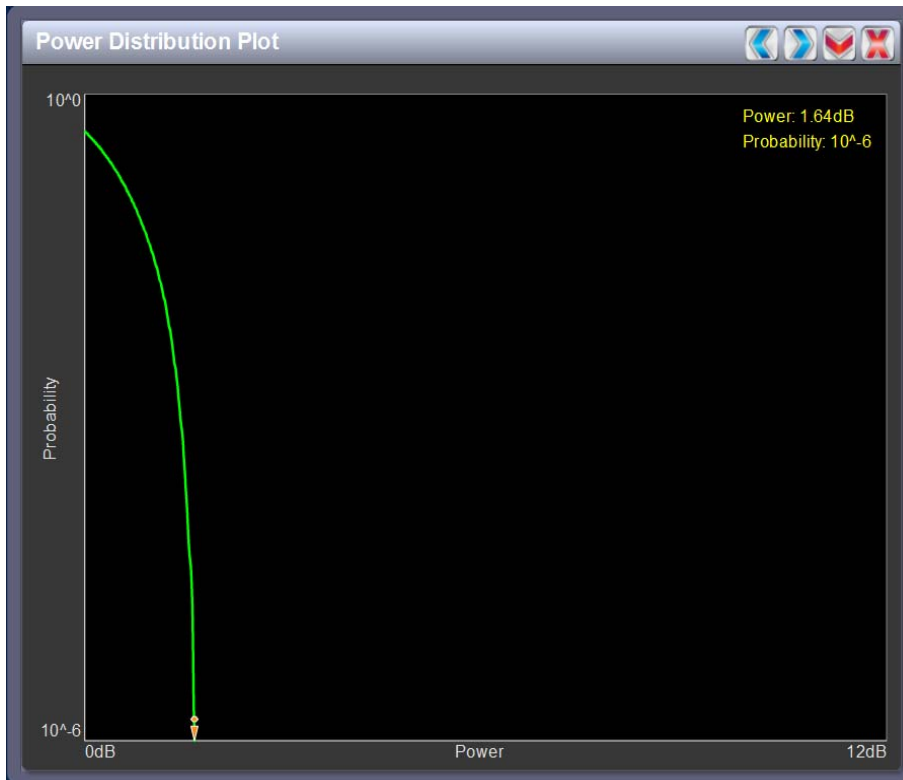
Figure 3.2.37: Power Distribution Plot

Power Distribution Plot

See [Figure 3.2.37](#). The exciter measures the relative power levels of the signal and determines the probability of exceeding a given power level, relative to the average power. The data is plotted in the Power Distribution Plot as a CCDF (complementary cumulative distribution function). The x-axis displays the relative power level in dB, with the reference representing the average power. The average power is 0 dB. The y-axis displays the probability of exceeding that power level. This plot can be used to assess the distribution of a given signal, and provides an indication of the amount of peak power capability required from the transmitter in order to prevent peak clipping/distortion of the output signal.

Touch on the panel to display a cursor in the approximate area. The cursor position (power gain and probability index) is noted in the upper, right-hand corner of the panel. Touch in other areas of this instrument panel to provide a coarse adjustment of the cursor position.

Use the left and right buttons as fine adjustments.

Use the maximize or minimize buttons as required.

Viewing Real-Time Meters

You can view meters using the AUI (see [Viewing Real-Time Meters - using the Controller UI](#), on page 3.2.57) or using the controller UI (see [Viewing Real-Time Meters - using the Controller UI](#), on page 3.2.57).

Viewing Real-Time Meters - using the AUI

The AUI can be used to display metered parameters on the Home page (see [Figure 3.2.38](#)), if selected individually from the Meters List View page or saved in a meter list layout and set to default.

This section includes the following topics:

- [Describing the Meter Display](#), on page 3.2.54
- [Accessing Meter Information](#), on page 3.2.54
- [Identifying Meter Information on a Specific Sub-device](#), on page 3.2.55
- [Saving a Meter List](#), on page 3.2.56

Figure 3.2.38: Meters Page

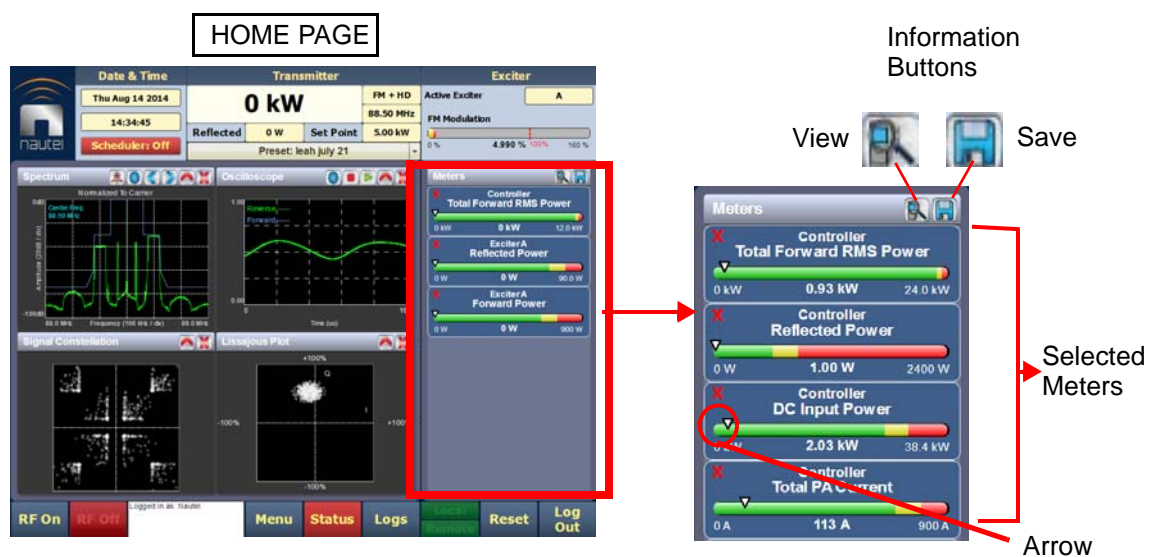

Describing the Meter Display

The meters displayed in the AUI represent the active meters selected for display. Each meter is a colour-coded bar with minimum and maximum values (see [Figure 3.2.38](#)). The current value for a meter is indicated by an arrow on the colour-coded bar, as well as a numeric value below the meter.

- ❖ A parameter value in the green section of a meter bar indicates the parameter is within the range for normal operation.
- ❖ A parameter value in the yellow section (as applicable) of a meter bar indicates the parameter is still within an operational range, but is approaching design limitations.
- ❖ A parameter value in the red section of a meter bar indicates the parameter is outside normal operating conditions.

Accessing Meter Information

Procedures for accessing and editing information in the Meters section of the AUI screen:

- ❖ To delete a meter from the Home page, press **X** in the Meters window ([Figure 3.2.39](#)).
- ❖ To review all the meter options, press the meter list view shortcut button (magnifying glass) at the top of the meters panel (see [Figure 3.2.39](#)). This will open the Meter List View window.
- ❖ On the Meter List View screen users can see all relevant meters of a sub-device. Select the sub-device in question under the Transmitter Layout column and the Relevant Meters column will be populated. The desired Meters can now be selected.

Figure 3.2.39: Meters List View Window (Exciter A shown)

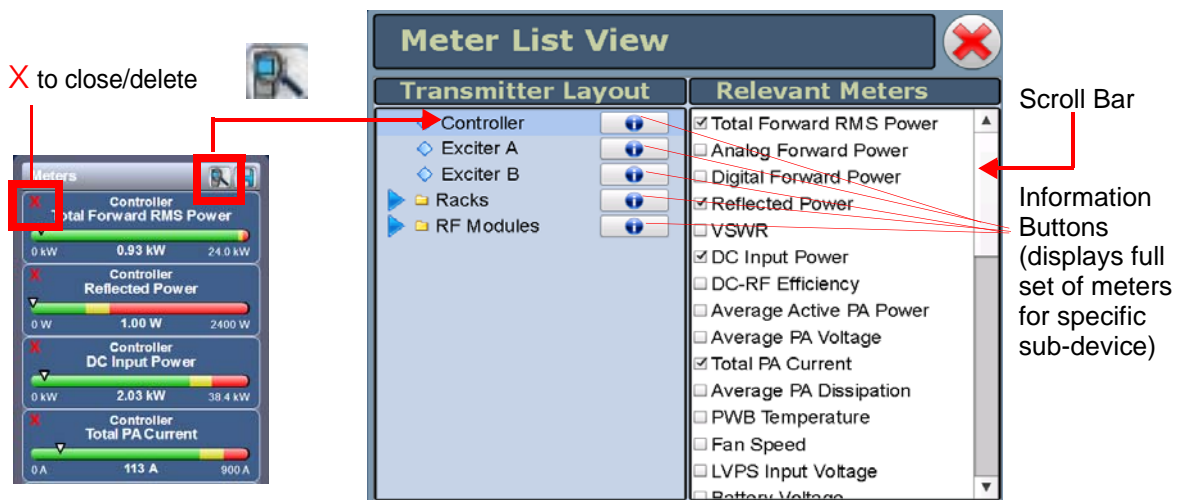

Identifying Meter Information on a Specific Sub-device

- Open the Meters List View window and select one of the desired transmitter sub-devices.
 - ❖ Controller
 - ❖ Exciter A or B
 - ❖ Rack - Multiple racks supported
 - ❖ RF Modules - Multiple modules supported
- Under Transmitter Layout, press the information button (i) beside a device type. This will open an information window in tabular format (see [Figure 3.2.40](#)).
- To choose individual meters for display in the Meters window of the Home page: Select the device type name in the Transmitter Layout panel and select the checkbox next to the desired meters shown in the Relevant Meters panel (see [Figure 3.2.39 on page 3.2.54](#)). If the Relevant Meters panel contains more than one page of information, use the scroll bar (right-side) to find the desired meter

NOTE: When a meter value is updated, a blue box briefly appears around that value. Typically, updates occur every one or two seconds.

Figure 3.2.40: Meters - Information (Device type Controller shown)

Controller

Firmware Version		1.0.0.74	
CPLD Version		1.0.0.0	

Meters

Local/Remote	Remote	Total PA Current	0 A	+1.8V	1.82 V	Splitter Fan 1 Speed	0 rpm
RF On/Off	Off	Average PA Dissipation	0 W	+1.2V	1.19 V	5kW Reject Fan 1 Speed	0 rpm
Total Forward RMS Power	0 kW	PWB Temperature	45.9 °C	Total RF Drive Power	6.10 W	5kW Reject Fan 2 Speed	0 rpm
Analog Forward Power	0 kW	Fan Speed	0 rpm	Total Reject Power	0 W	5kW Reject Fan 3 Speed	0 rpm
Digital Forward Power	0 kW	LVPs Input Voltage	48.0 V	5kW Reject 1-2 Power	0 W	10kW Reject Fan 1 Speed	0 rpm
Reflected Power	0 W	Battery Voltage	3.06 V	5kW Reject 3-4 Power	0 W	10kW Reject Fan 2 Speed	0 rpm
VSWR	N/A	+15V	15.1 V	5kW Reject 5-6 Power	0 W	Final Reject Fan 1 Speed	0 rpm
DC Input Power	0 kW	+12V A (AUI)	12.0 V	5kW Reject 7-8 Power	0 W	Final Reject Fan 2 Speed	0 rpm
DC-RF Efficiency	N/A	+12V B (BBC)	12.2 V	10kW Reject 1-4 Power	0 W		
Average Active PA Power	0 W	+5V	4.67 V	10kW Reject 5-8 Power	0 W		
Average PA Voltage	1.89 V	+3.3V	3.34 V	20kW Reject 1-8 Power	0 W		

Alarms

Exciter B Offline

Monitor Fan Fail

Saving a Meter List

NOTE: Meter lists are associated with user accounts. Lists saved in this screen are only displayed in the current user account. Setting a list as default will define the meters that will appear when logging into the current account (or after an ac power interruption in the local AUI if this is the default user account).

To save meter specifics for display on the Home page:

Open the Meter List Save window from the Home page using the floppy disk button (Figure 3.2.41).

- ❖ Press Save As to save the currently displayed meters. Enter a name in the Layout Name entry box and press OK.
- ❖ Press Delete to discard the selected meter list.
- ❖ Press Set Default to set the selected meter list as the default for the current user account. The * symbol shows the default.
- ❖ Press Save to overwrite the selected meter list with the currently displayed meters.
- ❖ Press Load to display the meters saved under the currently selected meter list in the Meters panel on the right-hand side of the Home page.

Figure 3.2.41: Meter List Save Window

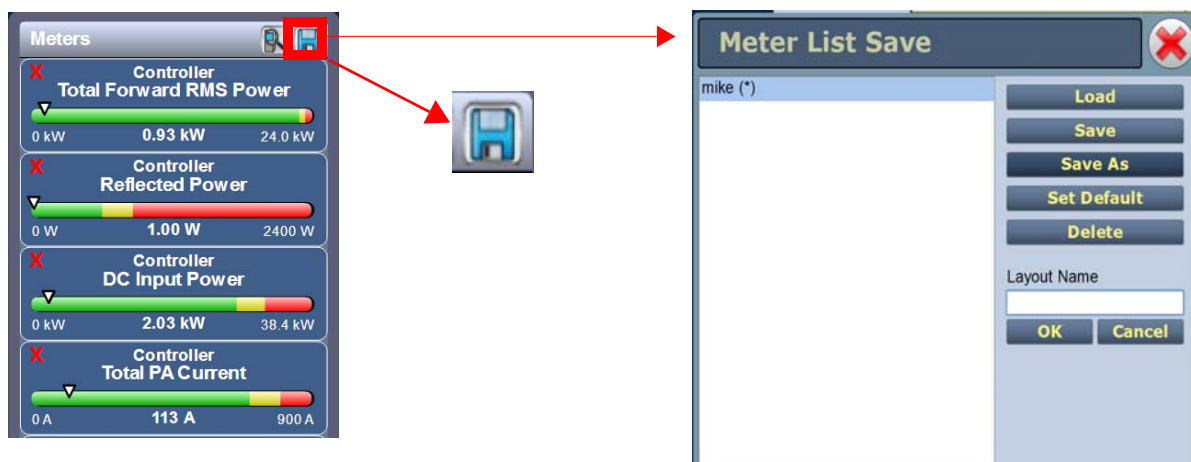

Viewing Real-Time Meters - using the Controller UI

When you select View Status -> View Meters from the Main Menu (see [Figure 3.2.42](#)) you can view various metered parameters of the GV5/GV3.5. These parameters are divided into sections. When you select a particular section, the applicable meters are displayed as a list on the appropriate screen.

NOTE: *The View Meters screens are for viewing purposes only and do not offer the same level of analytical features as the AUI's Meter List View page (see [Figure 3.2.38](#) on page 3.2.53).*

Figure 3.2.42: View Meters Screens

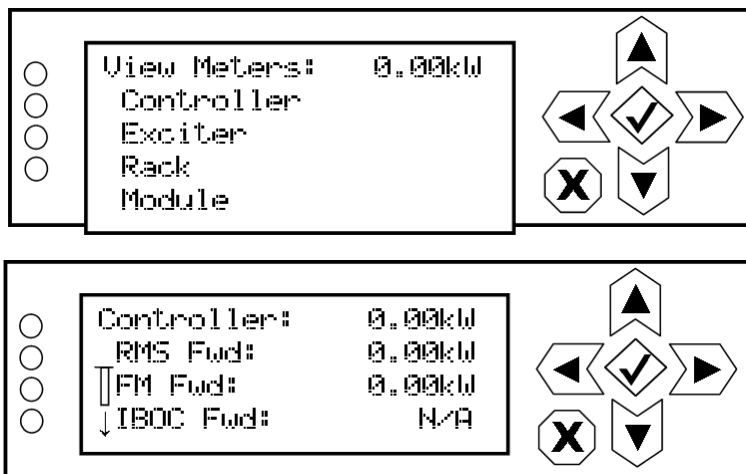

Controller screen shown,

See the tables on the following pages for full list of meters available for Controller, Exciter, Rack and RF Module sections.

Use the up and down buttons to scroll through the meter sections. Press the accept (checkmark) button to enter the meters screen for that section (see Controller example in [Figure 3.2.42](#)). Use the up and down buttons to scroll through the list of metered parameters, noting that the following parameters are available for viewing:

CONTROLLER:

RMS Forward Power	+12 V B	Reject 13-16 Power, as applicable
FM Forward Power	+5V	Reject 1-8 Power, as applicable
IBOC Forward Power	+3.3V	Reject 9-16 Power, as applicable
Reflected Power	+1.8V	Splitter Fan 1 Speed
VSWR	+1.2V	Splitter Fan 2 Speed
DC Power In	RF Drive Power	Reject 5kW Fan1 Speed
DC-RF Efficiency	Total Reject Power	Reject 5kW Fan2 Speed
RF Power Per PA	Reject 1-2 Power	Reject 5kW Fan3 Speed
Avg. PA Volts	Reject 3-4 Power	Reject 5kW Fan4 Speed
Avg PS Current	Reject 5-6 Power, as applicable	Reject 5kW Fan5 Speed
Total PA Current	Reject 7-8 Power, as applicable	Reject 5kW Fan6 Speed
Avg. PA Dissipated Power	Reject 9-10 Power, as applicable	Reject 10kW Fan1 Speed
PWB Temperature	Reject 11-12 Power, as applicable	Reject 10kW Fan2 Speed
Fan Speed	Reject 13-14 Power, as applicable	Reject 10kW Fan3 Speed
LVPS Voltage	Reject 15-16 Power, as applicable	Reject Final Fan1 Speed
Battery Voltage	Reject 1-4 Power	Reject Final Fan2 Speed
+15V	Reject 5-8 Power, as applicable	Reject Final Fan3 Speed
+12V A	Reject 9-12 Power, as applicable	

EXCITER (A/B, AS APPLICABLE):

Exc Fwd Power	Exc -15V	Dig 2 R Level
Exc Refl Power	Exc +5V_A	MPX SCA Level
Exc PA VSWR	Exc +5V_B	MPX RMS %
Exc PA Voltage	Exc +3.3V	AGC Limit %
Exc PA Current	Exc +1.8V	MPX Limit %
Exc PA Bias Voltage	Exc +1.2V	Delta 10 MHz
Exc PA Dissipation	Exc Battery Voltage	MPX RMS %
Exc Preamp Voltage	Exc Peak Mod %	DAC Gain %
Exc Preamp I (current)	Bal L Level	Forward Attenuation
Exc Preamp Bias Voltage	Bal R Level	Reverse Attenuation
Exc Fan Voltage	MPX Level	Reverse Gain
Exc Fan Speed	Int SCA1 Level	Mask Delta
Exc PA Temp	Int SCA2 Level	Exc Tilt
Exc PWB Temperature	Dig 1 L Level	Exc Data MER
Exc LVPS	Dig 1 R Level	Exc Ref MER
Exc +15V	Dig 2 L Level	Exc 10 MHz Delta (ppm)

RACK # (1 THROUGH 8, AS APPLICABLE):

Rk +15V	Rk LVPS
Rk +5V	Rk Ambient Temperature
Rk +3.3V	Rk Reject Fan Voltage

RF MODULE (PM1, REPEAT FOR PM2):

PM1 Drive Power	PM1 PS A Input Voltage	PM1 Temperature
PM1 PA Voltage A	PM1 PS B Input Voltage	PM1 PS A Voltage
PM1 PA Voltage B	PM1 PS A Input Current	PM1 PS B Voltage
PM1 PA 1 Curr	PM1 PS B Input Current	PM1 PS A Current
PM1 PA 2 Curr	PM1 Fan Voltage	PM1 PS B Current
PM1 PA 3 Curr	PM1 Fan 1 Speed	PM1 PS A Fan Speed
PM1 PA 4 Curr	PM1 Fan 2 Speed	PM1 PS B Fan Speed
PM1 Bias 1 Voltage	PM1 Fan 3 Speed	PM1 PS A Temperature
PM1 Bias 2 Voltage	PM1 Fan 4 Speed	PM1 PS B Temperature
PM1 Bias 3 Voltage	PM1 Fan 5 Speed	PM1 PS A Run Time
PM1 Bias 4 Voltage	PM1 Fan 6 Speed	PM1 PS B Run Time
PM1 Reject Power		

Presets - Editing Operational Settings

You can manage presets using the AUI (see [Managing Presets - using the AUI](#)) or using the controller UI (see [Managing Presets - using the Controller UI, on page 3.2.74](#)).

Managing Presets - using the AUI

The Presets page (see [Figure 3.2.43](#)) allows users with the appropriate permissions to view operational data (power level, frequency, mode, program input characteristics), plus create and control preset settings. Users can create up to 62 presets or edit existing presets. To view the Presets page, select Presets in the Menu page. This section includes the following topics:

- [Editing or Creating Presets, on page 3.2.61](#)
- [Loading Presets, on page 3.2.62](#)
- [Understanding the Preset Tabs, on page 3.2.63](#)

Figure 3.2.43: Presets Page - General Tab

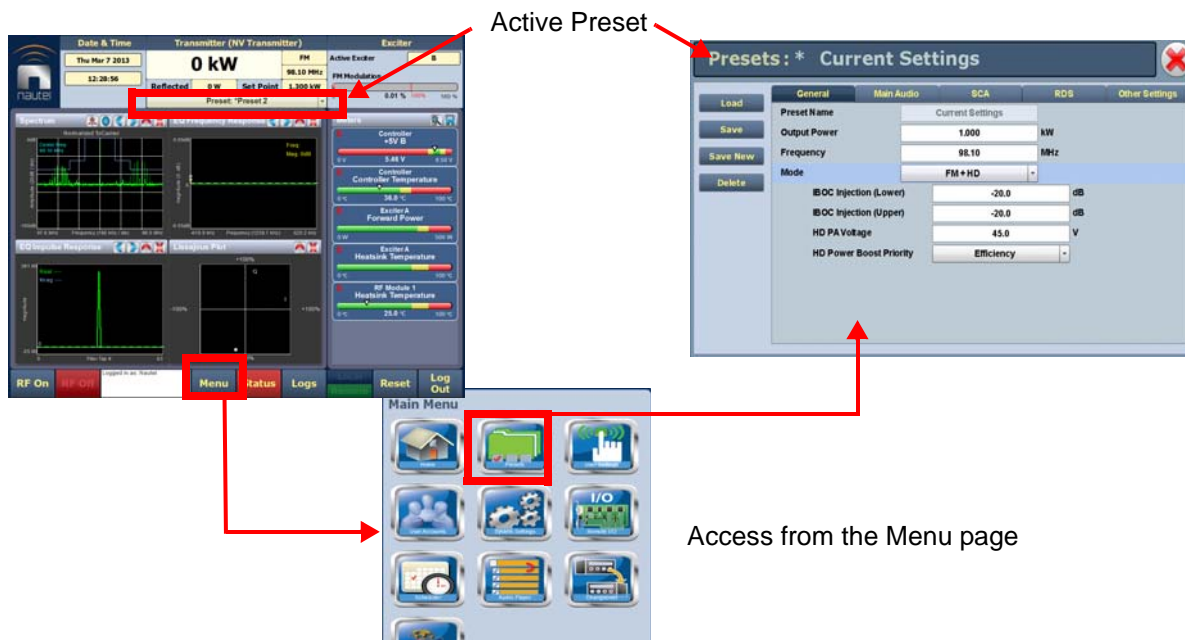

NOTE: When asked to enter a value in a field, an error message may appear (red text at the bottom of the screen) showing the limits of the requested value. Re-enter the desired value, ensuring it falls within the limits shown.

For example: **Output Power - Valid values: 0.15kW to 5.5kW**

Editing or Creating Presets

When a presets page is opened from the menu, (for example see [Figure 3.2.43 on page 3.2.60](#)), the Current Settings of the transmitter are displayed. They define the current operational state of the transmitter. Current Settings can be edited and then immediately activated by pressing the Save button.

To edit a saved preset, you must load that preset from the Presets page (see [Loading Presets, on page 3.2.62](#)). If the edited preset was active before it was edited, saving the preset will update the preset, but the Current Settings will not change. To update the operation of the transmitter, re-activate the preset through the top banner (see [Activating Presets, on page 3.2.62](#)).

In the top banner (see [Activating Presets, on page 3.2.62](#)), an asterisk (*) appears next to the preset name when the Current Settings have changed since the last preset was loaded. Current Settings are not saved through an ac power cycle; when the transmitter recovers from an ac power loss, it loads the preset that was last activated.

On the Presets page, an asterisk (*) appears next to the preset name in the header when there are unsaved changes to the preset.

When changes are complete, press the Save button and then press the Save Preset window's Save button to enable the changes. If you are creating a new preset, you can also enter a new name (e.g., Preset 4 - IBOC) in the preset window before clicking the Save or Save New button.

Parameters that can be edited are discussed in detail in [Understanding the Preset Tabs, on page 3.2.63](#).

To remove a preset, select it and press the Delete button.

To ignore any changes, press Cancel to return to the Presets page.

NOTE: *If you change an FM+HD or HD preset, particularly its power level or frequency, it is possible to optimize the transmitter's performance using the HD Optimizer function (see [Spectrum/Efficiency Optimizer, on page 3.2.108](#) or [Optimizing HD Parameters, on page 3.2.118](#)).*

Loading Presets

When first entering the Presets page, the current "active" preset is displayed (see [Figure 3.2.43 on page 3.2.60](#)). If the current preset is not the desired one, use the Load button on the left-side of the AUI to call up a window containing a list of available presets.

Select the desired preset and press the Load button to view or enable editing of the preset. Press the Delete button to delete the selected preset. Users cannot delete the current "active" (operational) preset or any preset that is referenced in the Remote I/O menu as either a remote input or output. Those links in the Remote I/O menu must be deleted before the associated preset can be deleted. Press Cancel to return to the Presets page.

Activating Presets

In the Transmitter block in the AUI's top banner, press the bar that contains the active preset name and the drop-down arrow (see [Figure 3.2.44](#)). The Activate Preset window will appear, which contains a list of all preset options. Press and highlight the desired preset and press the Activate button to enable the preset as the transmitter's active preset. Press the Cancel button to close this window.

Figure 3.2.44: Activating Presets



Understanding the Preset Tabs

The Presets page consists of tabs across the top with functions on the left-side and parameters displayed in the center and right-side of the window. A separate display appears for each of the following tabs:

General - (see [Figure 3.2.43](#) on page [3.2.60](#))

- **Preset Name** : This field identifies the current preset settings. Users must load a preset to directly edit this field (see [Activating Presets](#), on page [3.2.62](#)).
- **Output Power**: Set the output power level (in kW). Output power limits are a function of the transmitter mode of operation (see Table 1-1 of the Pre-Installation Manual for RF output power ratings for this transmitter).
- **Frequency**: Set value. Valid frequencies are between 87.00 and 108.00 MHz.
- **Mode**: Set the overall transmission mode. Available options are:
 - ❖ **FM**: an analogue only mode, transmits a carrier, frequency modulated with audio.
 - ❖ **HD**: all digital mode; this mode transmits the upper and lower digital sidebands of OFDM IBOC carriers. HD transmitter is typically high-level combined (coupler or spatial) with a paired FM only transmitter. See page [3.2.64](#) for additional calibration settings. This mode requires additional hardware.
 - ❖ **FM+HD**: also known as hybrid/simulcast or low-level combined, this mode transmits the analog carrier (FM modulated) and the upper and lower digital sidebands of OFDM IBOC carriers. See page [3.2.64](#) for additional calibration settings. This mode requires additional hardware.
 - ❖ **DRM+**: transmits a DRM OFDM signal using the I/Q stream from a DRM modulator connected to the desired AES input. See page [3.2.64](#) for additional calibration settings. This mode requires additional hardware.

NOTE: *Settings on the Presets tabs are shown/hidden based on the chosen settings. Not all settings are available in all modes.*

Mode - Additional Calibration Settings:

- ❖ IBOC Injection (Lower): for FM+HD and HD modes, enter value, in dB, between -20 and -10 dB for the IBOC injection level of the lower sideband of digital carriers. This value determines the relationship between the digital carriers power and the analog carrier power. Example: -20 dB indicates that the total RMS power of the digital carriers will be 1/100 of the total RMS power of the analog carrier. -10 dB indicates that the total RMS power of the digital carriers will be 1/10 of the total RMS power of the analog carrier.
- ❖ IBOC Injection (Upper): for FM+HD and HD modes, enter value, in dB, between -20 and -10 dB for the IBOC injection level of the lower sideband of digital carriers. This value determines the relationship between the digital carriers power and the analog carrier power. Example: -20 dB indicates that the total RMS power of the digital carriers will be 1/100 of the total RMS power of the analog carrier. -10 dB indicates that the total RMS power of the digital carriers will be 1/10 of the total RMS power of the analog carrier.

NOTE: *The actual digital sideband power is 3 dB less than that indicated in the upper or lower IBOC Injection fields; Example: if -20 dBc is entered in the upper and lower IBOC Injection fields, the upper and lower digital sideband power levels are actually -23 dBc; this way, when added, the resultant total digital power level is -20 dBc.*

For symmetrical sideband transmission: if -14 dBc IBOC Injection level is desired (total digital power of upper + lower sidebands is 4% of analog carrier power), set the upper and lower IBOC Injection levels to -14 dBc.

For asymmetrical sideband transmission, account for the fact that the actual sideband power level is 3 dB less than that shown. For example, if the upper digital sideband IBOC Injection level is entered as -14 dBc, the actual power level will be -17 dBc. This is equally true for the lower digital sideband.

- ❖ HD PA Volts: for FM+HD, HD and DRM+ modes, enter value, in volts, between 30.0 V and 53.0 V (default is 53.0 V). This value sets the drain voltage applied to the PAs in the RF power modules, from their associated power supplies. This value affects IBOC/DRM+ performance. Larger values result in an improved spectrum, but decreased efficiency. Conversely, smaller values result in improved efficiency, but degrade the spectrum. Typical values are between 35 V and 50 V, and depend on many variables such as power level, frequency and injection level. You can also use the HD optimizer feature to maximize your transmitter's performance (see [Spectrum/Efficiency Optimizer](#), on page 3.2.108 or [Optimizing HD Parameters](#), on page 3.2.118).
- ❖ HD Power Boost: for FM+HD mode only. Enable this setting to engage Nautel's digital PowerBoost process, an advanced peak-to-average power ratio reduction that increases hybrid-mode transmitter efficiency and power capability. When enabled, selection options are Priority: Efficiency and Priority: MER.

Figure 3.2.45: Presets - Main Audio

The screenshot displays the Nautel transmitter control interface. At the top, there are three main sections: **Date & Time** (Wed Aug 6 2014, 16:00:11, Scheduler: Off), **Transmitter (leah)** (0 kW, 88.50 MHz, Reflected 0 W, Set Point 10.00 kW, Preset: *leah july 21), and **Exciter** (Active Exciter A, FM Modulation 112.9%).

The main area is titled **Presets: * Current Settings** and contains a sidebar with **Load**, **Save**, **Save New**, and **Delete** buttons. The settings are organized into tabs: **General**, **Main Audio**, **SCA**, **RDS**, and **Other Settings**. The **Main Audio** tab is active, showing the following parameters:

- Audio Source: Left/Right/Mono
- Analog Level: 0.0 dBu
- Audio Mode: Stereo
- 15kHz Lowpass: Off
- Preemphasis: 0us
- Main Audio Gain Adjust: 0.0 dB
- Audio Backup: Enable

Below these settings, there is a section for backup audio source settings:

- Audio Source: Left/Right/Mono
- Analog Level: 0.0 dBu
- Audio Mode: Mono L+R
- 15kHz Lowpass: Off
- Preemphasis: 0us

At the bottom of the interface, there are control buttons: **RF On**, **RF Off**, **Menu**, **Status**, **Logs**, **Local Remote**, **Reset**, and **Log Out**. The status bar also shows "Logged in as: Nautel".

Main Audio - (see [Figure 3.2.45 on page 3.2.65](#)):

- Audio Source: Connects the appropriate exciter input for use. Available options are:
 - ❖ Left/Right/Mono: this source allows for further configuration via Analog Level, Audio Mode (Mono L+R, Mono L, Mono R, Stereo), 15kHz Lowpass, Preemphasis, Main Audio Gain Adjust settings (see below).
 - ❖ MPX: this source allows for further configuration via the MPX Level setting (see below).
 - ❖ Primary Digital: this source allows for further configuration via Digital Level, Audio Mode (Mono L+R, Mono L, Mono R, Stereo), 15kHz Lowpass, Preemphasis, Main Audio Gain Adjust settings (see below).
 - ❖ Secondary Digital: this source allows for further configuration via Digital Level, Audio Mode (Mono L+R, Mono L, Mono R, Stereo), 15kHz Lowpass, Preemphasis, Main Audio Gain Adjust settings (see below).
 - ❖ MPX Over AES: this source allows for further configuration via the Digital Level setting (see below).
 - ❖ Audio Player Over AES: this source allows for further configuration via the Digital Level setting (see below).
 - ❖ Analog Level: applies to Left/Right/Mono source only; enter value between -12 and +12 dBu, which represents the input voltage level that yields 100% modulation (typically 4.7 dBu).
 - ❖ Digital Level: applies to Primary Digital, Secondary Digital and MPX Over AES sources only; enter value between -25.5 and 0 dBFS (typically -4 dBFS for 100% modulation value).
 - ❖ Audio Mode: select Mono L, Mono R, Mono L+R or Stereo (applies to Left/Right/Mono, Primary Digital or Secondary Digital sources; selecting Stereo applies a 19 kHz pilot).
 - ❖ 15kHz Lowpass Filter: applies to Left/Right/Mono, Primary Digital, and Secondary Digital audio modes; select On (applies 15 kHz low-pass filter to audio input) or Off.
 - ❖ Preemphasis: select 0 us, 25 us, 50 us or 75 us. This setting applies to all sources except MPX.
 - ❖ Main Audio Gain Adjust: applies to Left/Right/Mono source only; allowable range is -20 to 10 dB. This configuration setting will increase the incoming signal level and yield a proportional increase in % modulation.
 - ❖ MPX Level: applies to MPX source only. Set this parameter level in Vpp (typically 3.5 Vpp - 100% modulation value). The allowable range for this setting is between 1-5 Vpp.
 - ❖ Audio Backup: When you set Audio Backup to Enable, you can select a backup Audio Source and edit various parameters for the backup audio similarly to the main audio described above. The backup audio source, if enabled and present, will replace the main audio source if the main audio level is less than its user-determined trip threshold (see [Setting User Thresholds, on page 3.2.161](#)). The main audio source will be restored as the active source if it returns and is present for at least one second.

Figure 3.2.46: Presets - SCA

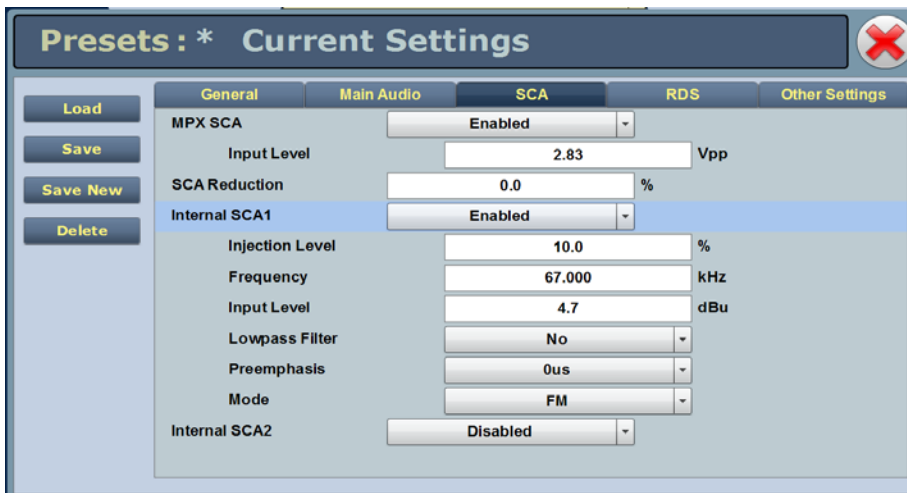

SCA - (see Figure 3.2.46):

- MPX SCA: Connector (J7:A for SCA1, J7:B for SCA2) for use with an externally generated SCA; select Enabled or Disabled. When enabled, all the selections listed below are active.
 - ❖ Input Level: signal level that represents 10% modulation. Enter a value between 1 and 5 V p-p (typically 2.83 V p-p).
- SCA Reduction: Attenuation applied to the SCA input; set between 0 and 20% (used to reduce the modulation level of the main audio when SCAs are enabled; typically, for every 2% of SCA modulation, the main audio modulation must be reduced by 1%).
- Internal SCA1/2: Enable or disable the appropriate internal SCA (SCA1 or SCA2). When enabled, the settings listed below are active for the associated SCA signal (1 or 2).
 - ❖ SCA1 or SCA2 Injection Level: enter value between 0 and 20% (typically 10%); this level is added to the composite baseband signal.
 - ❖ SCA1 or SCA2 Frequency: enter value between 20 and 100 kHz (typically set to 67 kHz or 92 kHz).
 - ❖ SCA1 or SCA 2 Input Level: enter value between -12 and +12 dBu, which represents the input voltage level that yields 10% modulation (typically 4.7 dBu).
 - ❖ SCA1 or SCA2 Lowpass Filter: select Enabled (applies 7.5 kHz low-pass filter to audio input) or Disabled.
 - ❖ SCA1 or SCA2 Preemphasis: select 0 us, 50 us, 75 us or 150 us.
 - ❖ SCA1 or SCA2 Mode: select FM (frequency modulated sub-carrier, typical) or DSB-SC (double side band suppressed carrier).

Figure 3.2.47: Presets page - RDS tab (upper and lower sections)

UPPER SECTION

Setting	Value
RDS	Enabled
RDS Local Echo	Enabled
Data Source	Internal
Injection Level	5.0 %
Phase	0.0 °
Baud Rate	115200bps
PI Code (hex)	0x0000
PS Name	
Scrolling Enable/Speed	Fast
Scrolling PS Name	harlie delta echo foxtrot golf hote
Scrolling Type	Word
Radio Text	at is less but completely differer

LOWER SECTION

Setting	Value
Scrolling PS Name	harlie delta echo foxtrot golf hote
Scrolling Type	Word
Radio Text	at is less but completely differer
PTY	4: SPORT/TALK
PTYN	talk tim
Music/Speech	Speech
Traffic Info	None
Alt. Frequencies	None
Artificial Head	Off
Compression Flag	Off
Dynamic	Static
Stereo	Mono

NOTE: Refer to FCC guidelines for allowable modulation depth with SCAs or RDS enabled.

RDS - (see [Figure 3.2.47](#)):

- RDS: When Enabled, all the selections listed below are active.

NOTE: For RDS operation, an external unit or software can send data to the exciter. The exciter generates the RBDS carrier and injects the data. Nautel supports the strings listed below. The data format is XX=yyyy.

- ❖ RDS Local Echo: select Enabled or Disabled. When Enabled, the exciter RDS port transceiver will echo all inputs and controls received back to the terminal.
- ❖ Data Source: select Internal, Ext. ASCII, Ext. UECP, ASCII Over IP, UECP Over IP.

NOTE: For ASCII over IP data, for ASCII Over IP data, send RDS information to the IP address of the GV5/GV3.5, port 7005.

- ❖ Injection Level: enter value between 0 and 10% (typically 5%). This level is added to the composite baseband signal.
- ❖ Phase: enter value in degrees.
- ❖ Baud Rate: select 75, 150, 300, 600, 1200, 2400, 4800, 9600, 19200, 38400, 57600 or 115,200 bps. This selection does not apply to internal data sources.
- ❖ PI (programme identification) Code (hex): this unique code is used to identify a broadcast station. Every station gets assigned a specific code with a country identifying prefix. In the USA this code is determined by applying a formula to the station's call sign. Additional information can be found at www.nrcstandards.org. This selection applies to internal data sources only.
- ❖ PS (programme service) Name: this is simply an eight-character static display that represents the call letters or station identity name. Most RDS capable receivers display this information and, if the station is stored in the receiver's presets, will cache this information with the frequency and other details associated with that preset. This selection applies to internal data sources only.
- ❖ Scrolling Enable/Speed: select Off (disabled), Slow or Fast. Default is Off.
- ❖ Scrolling PS Name: if used, enter up to 64 characters for the PS name that will scroll (if enabled) at the speed selected in the Scrolling Enable/Speed field. This selection applies to internal data sources only.
- ❖ Scrolling Type: select the type of scrolling to be used by the receiver - Word or Character. Word scrolling displays one word of the Scrolling PS Name at a time. Character scrolling displays one character of the Scrolling PS Name at a time. The default selection is Word. This selection applies to internal data sources only.

- ❖ Radio Text: Most RDS radios can receive short messages that may include information about the presenter, station or program you are listening to. (e.g., a web address for the station). You can enter a radio text up to 64 characters scroll. This selection applies to internal data sources only.
- ❖ PTY: this coding of up to 31 pre-defined programme types allows users to find similar programming by genre. This selection applies to internal data sources only.
- ❖ PTYN (programme type name): this field can be used for detailed description of the PTY by 8 digits. Example: if the PTY is 4 (Sport) a PTYN like "Cycling" could be transmitted. The PTYN is intended for displaying additional information only and cannot be used for automatic station tuning like the PTY. The PTYN is optional and not obligatory. This selection applies to internal data sources only.
- ❖ Music/Speech: select Music or Speech. This selection applies to internal data sources only.
- ❖ Traffic Info: select None, TA (Traffic Announcement), TP (Traffic Programme) or TA+TP. The receiver can often be set to pay special attention to this flag and, for example, stop the tape/ pause the CD or retune to receive a traffic bulletin. The TP flag is used to allow the user to find only those stations that regularly broadcast traffic bulletins whereas the TA flag is used to signal an actual traffic bulletin in progress. This selection applies to internal data sources only.
- ❖ Alternate Frequencies: select None or 1 through 6. This allows a receiver to re-tune to a different frequency providing the same station information when the first signal becomes too weak. This is often utilized in car stereo systems. This selection applies to internal data sources only.
- ❖ Artificial Head: select Yes or No. This selection is a decoder identification operating mode flag.
- ❖ Compression Flag: select Yes or No. This selection is a decoder identification operating mode flag.
- ❖ Dynamic: select Yes or No. This selection is a decoder identification operating mode flag.
- ❖ Stereo: select Yes or No. This selection is a decoder identification operating mode flag.

NOTE: *Artificial Head, Compression Flag, Dynamic and Stereo are part of the DI (Decoder Information) data (see Controller UI editing screens on [Figure 3.2.70](#) on page 3.2.89). RDS Data is provided as a single-digit hex input between 0 and F, that encodes the flags for the four settings as a 4-bit code. For example: hex number 3 is bit-represented by 0011, from bit 3 on the left to bit 0 on the right. This number is decoded to mean Stereo = Yes (bit 0=1), Artificial Head = Yes (bit 1=1), Compression = No (bit 2=0) and Dynamic = No (bit 3=0).*

Figure 3.2.48: Presets page - Other Settings tab (upper, middle and lower sections)

Presets: * Current Settings 

General	Main Audio	SCA	RDS	Other Settings
Pilot Level		9.0	%	
Pilot 1PPS Sync		Enabled		
Pilot Sync Phase		0	°	
Sample Output		Pilot		
Audio Delay		Enabled		
Audio Delay		0.000	ms	
Auto Changeover Action				
Mod Loss Timeout		Enabled		
Action		None		
Timeout Minutes		0	min	
Timeout Seconds		5.0	sec	
Threshold		0	%	

UPPER SECTION

Presets: * Current Settings 

General	Main Audio	SCA	RDS	Other Settings
Hard Limiter		Enabled		
Hard Limit		160	%	
AGC Limiter		Enabled		
AGC Limit		120	%	
Time Constant		300	ms	
Two Slope Limiter		Enabled		
Threshold		160	%	
Gain		50.0	%	
Orban Processor		Enabled		
Orban Preset				
L/R Limiter		Enabled		
Max Gain		12.0	dB	

MIDDLE SECTION

Presets: * Current Settings 

General	Main Audio	SCA	RDS	Other Settings
Time Constant		300	ms	
Two Slope Limiter		Enabled		
Threshold		160	%	
Gain		50.0	%	
Orban Processor		Enabled		
Orban Preset				
L/R Limiter		Enabled		
Max Gain		12.0	dB	
Decay Time		5.000	s	
Hold Time		5.000	s	
MPX Power Limiter		Enabled		
MPX RMS Limit		0.0	dBr	

LOWER SECTION

Other Settings - (see [Figure 3.2.48](#)):

- Other Settings: Provides the following sub-functionality:
 - ❖ Pilot Level: enter value between 6 and 12 % (typically 9 %). This level is added to the composite baseband signal.
 - ❖ Pilot 1 PPS Sync: select Enabled or Disabled.
 - ❖ Pilot Sync Phase: if Pilot 1 PPS Sync is enabled, enter value between 0 and 360 degrees (typically 0 degrees).
 - ❖ Sample Output: determines which sample signal will be present on exciter's rear panel PILOT/MPX SAMPLE OUT BNC connector. Select Pilot (default setting, pilot sample present) or MPX (Composite) (composite baseband signal present).
 - ❖ Audio Delay: select Enabled, then enter value in the allowable range of 0 to 12000 ms. Default is 0. Audio Delay is used to time align the receiver output of decoded analog and digital audio signals.
 - ❖ Mod Loss Timeout: select Enable if so required. If Enable is selected the following sub-fields will appear:
 - Action: select the action to take on the loss of a modulating signal post the timeout period. Select **None** (no resulting action), **Inhibit** (inhibits the RF output and fans until the audio returns) or **Change Preset** (changes the active preset).
 - Mod Loss Preset: displayed only if Action is set to **Change Preset**. Select the preset from the drop down list that will activate upon the loss of a modulating signal, post the timeout period.
 - Timeout Minutes: sets the delay, in minutes, between modulation loss detection and the resulting action. Enter a value in the allowable range of 0 and 255 minutes.
 - Timeout Seconds: sets the delay, in seconds, between modulation loss detection and the resulting action. Enter a value in the allowable range of 0 and 59.9 seconds.
 - Threshold: sets the threshold for modulation loss detection. Enter a value in the allowable range of 0 and 100%. (see [Configuring a Mod Loss Backup Preset on page 3.4.4](#) for detailed instructions).
 - ❖ Hard Limiter: select Enabled, then enter the hard limit threshold percentage (allowable range is 0-160%, defaulted to 140%). If enabled, the modulation level will be limited (audio signal clipped or distorted) if it exceeds the hard limit threshold.

-
- ❖ AGC Limiter: select Enabled, then enter AGC Limit percentage (allowable range is 0-160%, defaulted to 120%) and Time Constant (allowable range is 0-1000 ms, defaulted to 0 ms). If Enabled, when the modulation level exceeds the AGC Limit, the gain of the audio input will instantly decrease in order to reduce the modulation level below the AGC limit threshold. Recovery from this audio gain reduction is dependent on the Time Constant delay (fast attack, slow recovery). The input signal is briefly distorted by the audio gain reduction when the threshold is exceeded.
 - ❖ Two Slope Limiter: if Enabled, when the modulation level exceeds the Threshold, the gain of the audio input will instantly change according to the gain percentage setting (percentage of the initial gain, that which is below the threshold). The input signal is distorted by the audio gain change.
 - Threshold: allowable range is 0-160%, defaulted to 120%.
 - Gain: allowable range is 0-100%, defaulted to 56.2%.
 - ❖ L/R Limiter: this look-ahead limiter can be applied to the signal immediately before the stereo generator in the exciter. It has a fixed attack time (and corresponding delay) of approximately 1 ms. It can be configured to reduce the signal, if the gain setting is 0 dB or less, or can be used to perform an AGC function and boost quiet sections of the audio if a positive gain setting is used. If Enabled, enter the following parameters:
 - Max Gain: allowable range is -20 to 20 dB, defaulted to 0 dB.
 - Decay Time: allowable range is 0 to 60 s, defaulted to 0 s.
 - Hold Time: allowable range is 0 to 60 s, defaulted to 0 s.
 - ❖ MPX Power Limiter: if Enabled, enter MPX RMS Limit . This limit allows the broadcast signal to remain in compliance with the MPX power limits as suggested in ITU-R BS.412-9. While the limiter will keep the transmitter in compliance, it is recommended that adjustment to the processing be made in such a way as to minimize the reductions performed by the limiter. Otherwise, the signal will not take advantage of the peak modulation capability available.
 - MPX RMS Limit (allowable range is -12 to 12 dB_r, defaulted to 0 s).

Managing Presets - using the Controller UI

The Presets page (see [Figure 3.2.43](#)) allows users with the appropriate permissions to view operational data (power level, frequency, mode, program input characteristics), plus create and control preset settings. Users can create up to 62 presets or edit existing presets. To view the Presets page, select Presets in the Menu page. This section includes the following topics:

- [Selecting the Active Preset](#)
- [Editing or Creating Presets](#)

Selecting the Active Preset

When you choose Select Preset from the Main Menu (see [Figure 3.2.49](#)) you can select the active preset for transmitter operation.

Figure 3.2.49: Select Preset screen

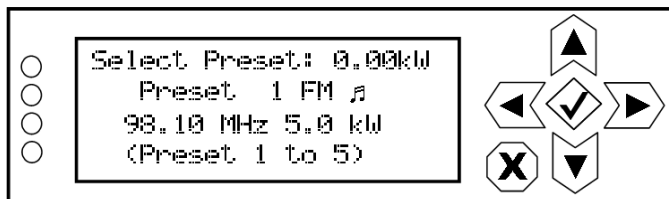

Use the up and down buttons to scroll through the existing presets. Press the accept (checkmark) button to enable the preset as the transmitter's active preset. Press the cancel (X) button to return to the previous menu.

Editing or Creating Presets

When you select User Settings -> Edit Presets from the Main Menu (see [Figure 3.2.50](#)) you can create up to 63 operating presets or edit existing presets.

Figure 3.2.50: Edit Preset screen

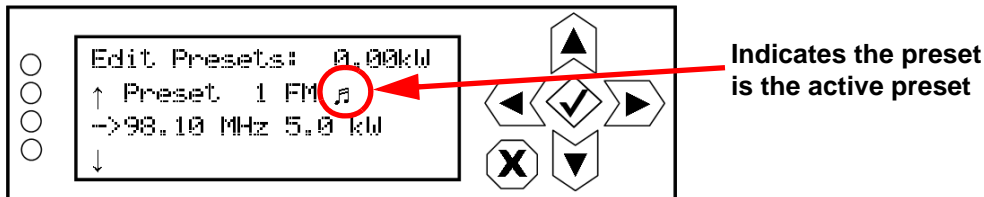

Use the up and down buttons to scroll through the existing presets, or scroll to the bottom of the list to Create New Preset (see [Figure 3.2.51](#)). Press the accept (checkmark) button to enter the editing menu for that preset (see [Figure 3.2.52](#)). Press the cancel (X) button to return to the previous menu. When you create a new preset, the next available preset number is assigned (e.g., Preset 5).

Figure 3.2.51: Create New Preset screen

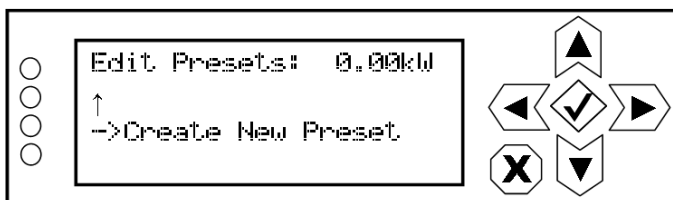
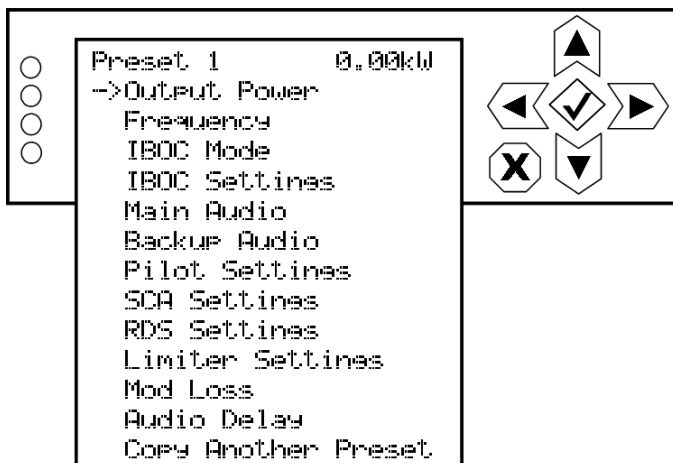

Figure 3.2.52: Preset Editing menu



Within the Preset Editing menu, use the up and down buttons to scroll through the options and press the accept (checkmark) button to enter the selected editing menu/screen. Press the cancel (X) button to return to the previous menu. Parameters that can be edited are:

OUTPUT POWER. See [Figure 3.2.53](#). Use the up and down buttons to edit the output power (in 50 W increments, then press the accept (checkmark) button to save the change.

For analog only transmitters [FM (analog) mode only], the maximum power setting is 5.5 kW (for GV5) or 4.15 kW (for GV3.5) and the minimum power setting is 0.15 kW (for both GV5 and GV3.5).

Press the cancel (X) button to discard changes and return to the previous menu.

Figure 3.2.53: Output Power screen

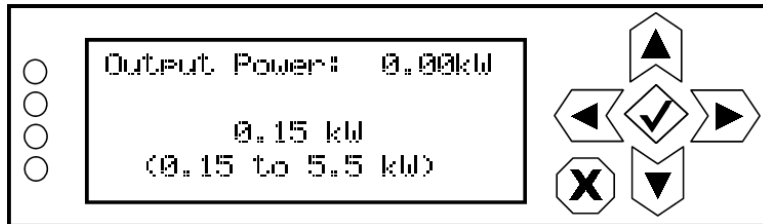

FREQUENCY. See [Figure 3.2.54](#). Use the up and down buttons to edit the carrier frequency (in 0.01 MHz increments, then press the accept (checkmark) button to save the change. Press the cancel (X) button to return to the previous menu.

Figure 3.2.54: Frequency screen

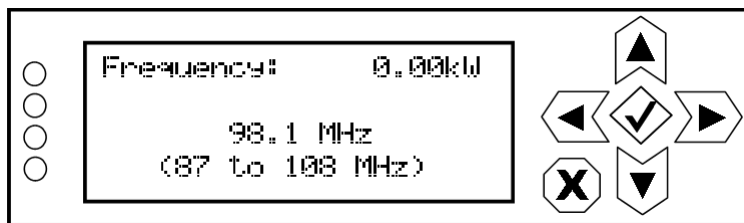

IBOC MODE. See [Figure 3.2.55](#). Use the up and down buttons to select the overall transmission mode, noting the options below, then press the accept (checkmark) button to save the change. Press the cancel (X) button to return to the previous menu.

Figure 3.2.55: IBOC Mode screen

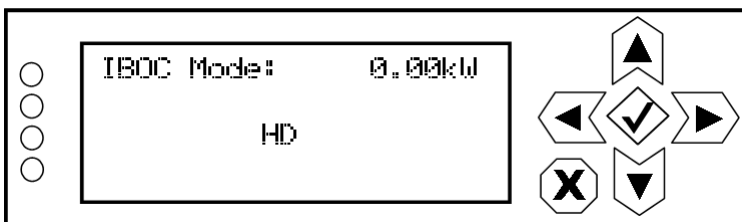

IBOC mode options include:

- ❖ FM: an analogue only mode, transmits a carrier, frequency modulated with audio.
- ❖ HD: all digital mode; this mode transmits the upper and lower digital sidebands of OFDM IBOC carriers. HD transmitter is typically high-level combined (coupler or spatial) with a paired FM only transmitter. See [IBOC Settings, on page 3.2.78](#) for additional calibration settings. This mode requires additional hardware.
- ❖ FM+HD: also known as hybrid/simulcast or low-level combined, this mode transmits the analog carrier (FM modulated) and the upper and lower digital sidebands of OFDM IBOC carriers. See [IBOC Settings, on page 3.2.78](#) for additional calibration settings. This mode requires additional hardware.
- ❖ DRM+: transmits a DRM OFDM signal using the I/Q stream from a DRM modulator connected to the desired AES input. See [IBOC Settings, on page 3.2.78](#) for additional calibration settings. This mode requires additional hardware.

IBOC SETTINGS. See [Figure 3.2.56](#). When you select IBOC Settings from the Preset editing options screen, you can edit various IBOC parameters

Figure 3.2.56: IBOC Settings menu

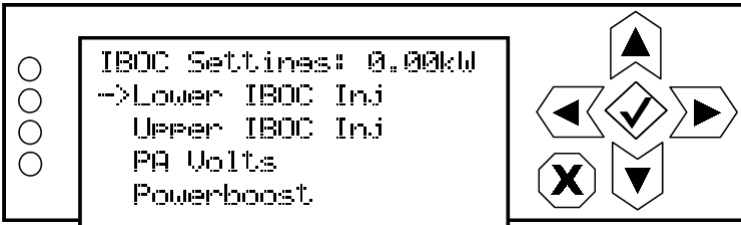

Use the up and down buttons to scroll through the IBOC settings options, then press the accept (checkmark) or right arrow button to enter the selected editing screen. [Figure 3.2.57 on page 3.2.79](#) shows the editing screens for the IBOC Settings menu. Press the cancel (X) button to discard changes and return to the previous menu.

Figure 3.2.57: IBOC Settings editing screens

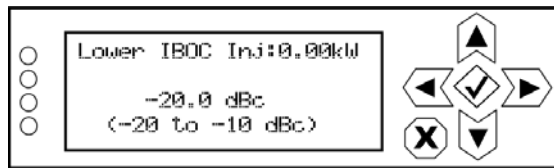

For FM+HD and HD modes, use the up and down buttons to select a value between -20 and -10 dB for the IBOC injection level of the lower sideband of digital carriers. This value determines the relationship between the digital carriers power and the analog carrier power. Example: -20 dBc indicates that the total RMS power of the digital carriers will be 1% of the total RMS power of the analog carrier. -10 dB indicates that the total RMS power of the digital carriers will be 10% of the total RMS power of the analog carrier.

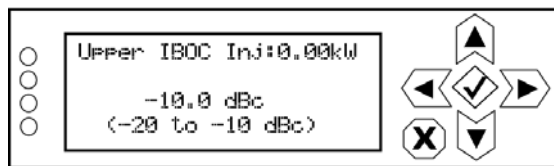

For FM+HD and HD modes, use the up and down buttons to select a value between -20 and -10 dB for the IBOC injection level of the upper sideband of digital carriers. This value determines the relationship between the digital carriers power and the analog carrier power. Example: -20 dBc indicates that the total RMS power of the digital carriers will be 1% of the total RMS power of the analog carrier. -10 dB indicates that the total RMS power of the digital carriers will be 10% of the total RMS power of the analog carrier.

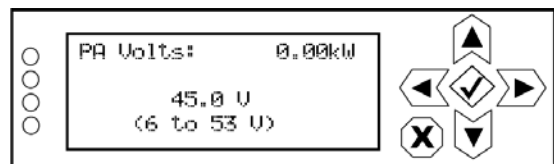

NOTE: The preferred option to maximize IBOC performance is by using the HD Optimizer feature (see [Optimizing HD Parameters, on page 3.2.118](#)). In this case, leave PA Volts setting at its default value (53.0 V).

For FM+HD, HD and DRM+ modes, use the up and down buttons to enter a value between 30.0 V and 53.0 V. This value sets the drain voltage applied to the PAs in the RF power modules, from their associated power supplies. This value affects IBOC/DRM+ performance. Larger values result in an improved spectrum, but decreased efficiency. Conversely, smaller values result in improved efficiency, but degrade the spectrum. Typical values are between 35 V and 50 V, and depend on many variables such as power level, frequency and injection level.

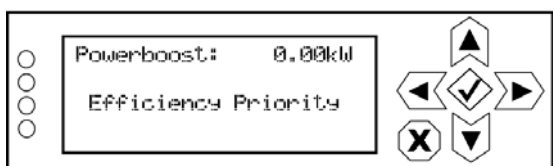

For FM+HD mode only. Use the up and down buttons to toggle between Efficiency Priority (default setting) and MAX MER Priority. Selecting Efficiency Priority instructs the PowerBoost function to make efficiency and power capability the priority when reducing the peak-to-average power ratio, while ensuring that the MER (modulation error ratio) of the transmitted HD signal meets transmission requirements.

Selecting MAX MER Priority instructs the PowerBoost function to make maximum MER the priority. Transmitter efficiency and power capability will be reduced as a result.

PowerBoost is only available in transmitters with the appropriate exciter configuration.

MAIN AUDIO. When you select Main Audio from the Preset editing options screen, you can edit various main audio parameters (see [Figure 3.2.58](#)).

Figure 3.2.58: Main Audio menu



Use the up and down buttons to scroll through the main audio menu options, then press the accept (checkmark) or right arrow button to enter the selected editing screen. [Figure 3.2.59 on page 3.2.81](#) shows the editing screens for the Main Audio menu. Press the cancel (X) button to discard changes and return to the previous menu.

Figure 3.2.59: Main Audio editing screens

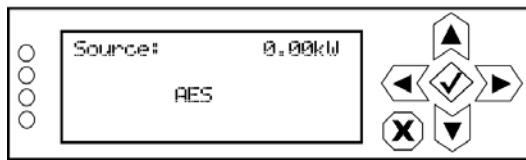

Use the up and down buttons to locate the desired audio source - MPX, Analog L/R, MPX Over AES, Audio Player -> AES 2, Audio Player -> AES 1, AES 2 or AES 1, then press the accept (checkmark) button to save the change. Press the cancel (X) button to discard changes and return to the previous menu.

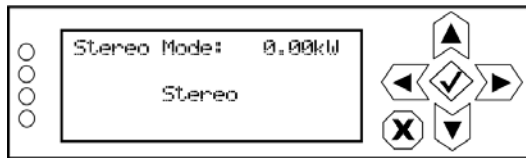

Use the up and down buttons to locate the desired stereo mode - Stereo, Right Mono, Left Mono or L+R Mono then press the accept (checkmark) button to save the change. Press the cancel (X) button to discard changes and return to the previous menu.

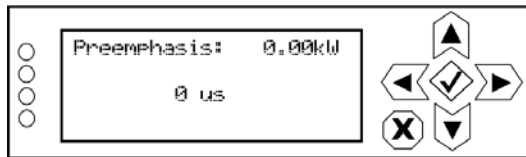

Use the up and down buttons to locate the desired preemphasis characteristic - 0 us, 25 us, 50 us or 75 us, then press the accept (checkmark) button to save the change. Press the cancel (X) button to discard changes and return to the previous menu.

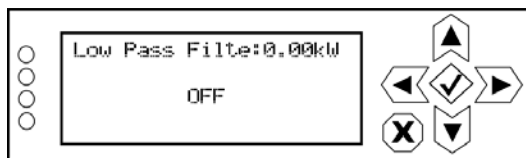

Use the up and down buttons to toggle between ON or OFF, then press the accept (checkmark) button to save the change. Press the cancel (X) button to discard changes and return to the previous menu. Default setting is OFF.

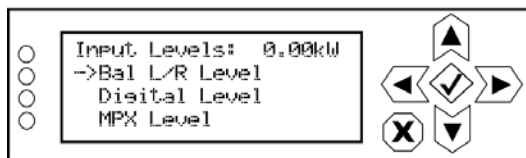

Use the up and down buttons to move the cursor to the desired audio input and then press the right button to enable editing of the parameter. [Figure 3.2.60 on page 3.2.82](#) shows all the editing screens for the Input Levels sub-menu. Within any of the editing screens, use the up and down buttons to edit a parameter value, noting the minimum and maximum limitations indicated at the bottom of the display. When complete, press the accept (checkmark) button to save the change. Press the cancel (X) button to discard changes and return to the previous menu.

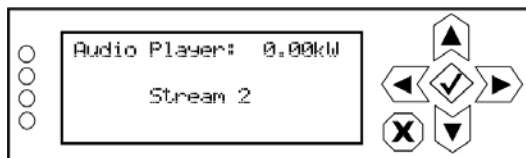

Use the up and down buttons to select File Playlist or Stream 1 through Stream 255, then press the accept (checkmark) button to save the change. Press the cancel (X) button to discard changes and return to the previous menu.

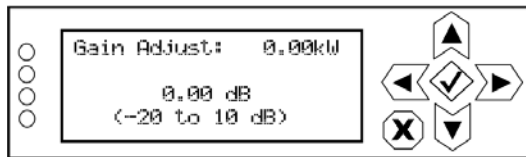

Use the up and down buttons to select again adjust level between -20 and 10 dB (in 0.01 dB increments), then press the accept (checkmark) button to save the change. Press the cancel (X) button to discard changes and return to the previous menu.

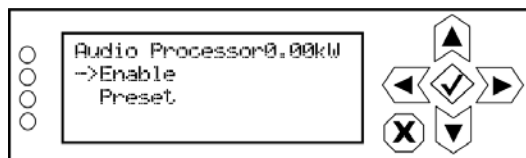

Use the up and down buttons to move the cursor to the desired sub-menu (Enable or Preset) and then press the right button to enable editing within the sub-menu. See [Enabling and Operating the Orban Audio Processor, on page 3.2.196](#) for more details. Press the cancel (X) button to discard changes and return to the previous menu.

Figure 3.2.60: Input Levels editing screens

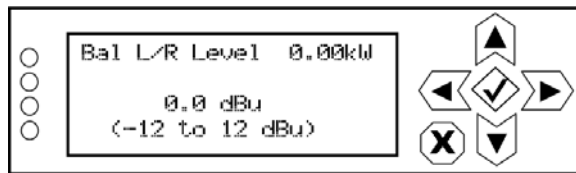

Use the up and down buttons to select a level between -12 and 12 dBu (in 0.1 dBu increments) then press the accept (checkmark) button to save the change. Press the cancel (X) button to discard changes and return to the previous menu. Default level is 0.0 dBu.

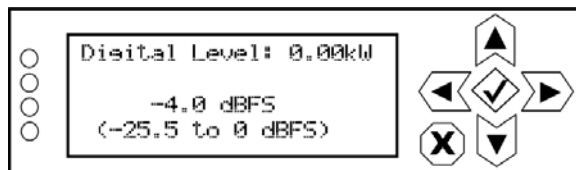

Use the up and down buttons to select a level between -25.5 and 0 dBFS (in 0.1 dBFS increments) then press the accept (checkmark) button to save the change. Press the cancel (X) button to discard changes and return to the previous menu. Default level is -4.0 dBFS.

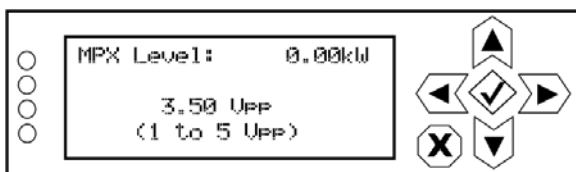

Use the up and down buttons to select a level between 1 and 5 V peak-to-peak (in 0.1 V increments), then press the accept (checkmark) button to save the change. Press the cancel (X) button to discard changes and return to the previous menu. Default level is 3.5 V pp.

BACKUP AUDIO. When you select Backup Audio from the Preset editing options screen, you can enable a backup audio source and edit various backup audio parameters (see [Figure 3.2.61](#)).

Figure 3.2.61: Backup Audio menu

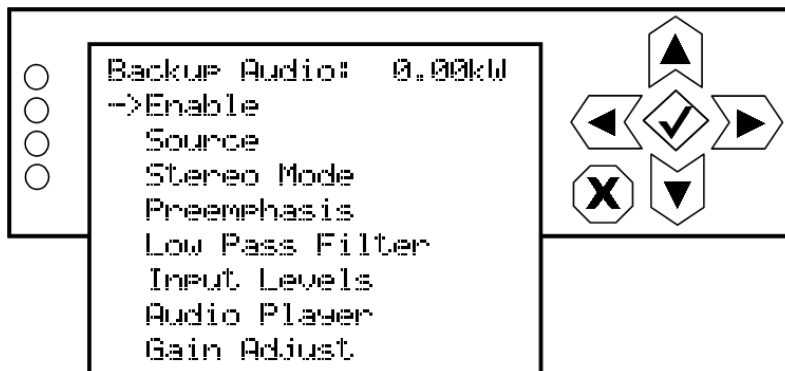

Use the up and down buttons to scroll through the backup audio menu options, then press the accept (checkmark) or right arrow button to enter the selected editing screen. With the exception of the Enable screen (select ON to enable, OFF to disable), the editing screens for the Backup Audio menu are the same as the Main Audio menu (see [Figure 3.2.59](#)). Press the cancel (X) button to discard changes and return to the previous menu.

PILOT SETTINGS. When you select Pilot Settings from the Preset editing options screen, you can edit the settings of the pilot signal (see [Figure 3.2.62](#)).

Figure 3.2.62: Pilot Settings menu

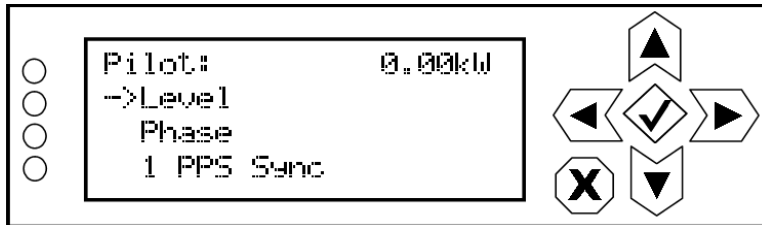

Use the up and down buttons to move the cursor to the desired pilot setting and then press the right button to enable editing of the parameter. [Figure 3.2.63](#) shows all the editing screens for the Pilot Settings menu. Within any of the editing screens, use the up and down buttons to edit or toggle a parameter value, noting the minimum and maximum limitations indicated at the bottom of the display. When complete, press the accept (checkmark) button to save the change. Press the cancel (X) button to discard changes and return to the previous menu.

Figure 3.2.63: Pilot Settings editing screens

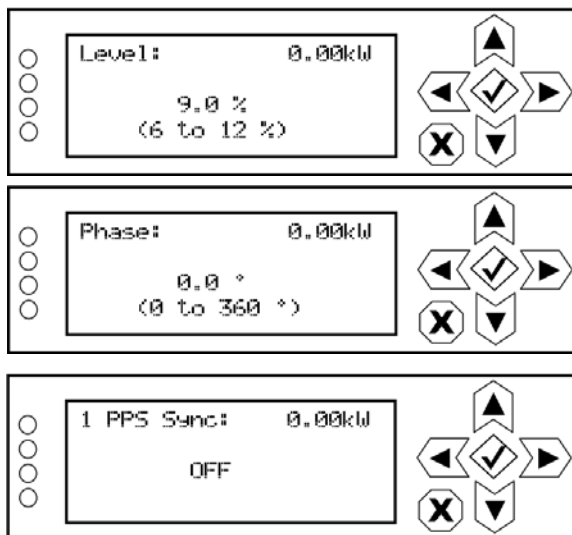

Use the up and down buttons to select a level between 6 and 12% (in 0.1% increments), then press the accept (checkmark) button to save the change. Press the cancel (X) button to discard changes and return to the previous menu. Default level is 9%.

Use the up and down buttons to select a phase angle between 0 and 360 degrees (in 0.1 degree increments), then press the accept (checkmark) button to save the change. Press the cancel (X) button to discard changes and return to the previous menu. Default level is 0.0 degrees.

Use the up and down buttons to select ON or OFF, then press the accept (checkmark) button to save the change. Press the cancel (X) button to discard changes and return to the previous menu. Default setting is OFF.

SCA SETTINGS. When you select SCA Settings from the Preset editing options screen, you can edit various SCA parameters (see [Figure 3.2.64](#)).

Figure 3.2.64: SCA Settings menu

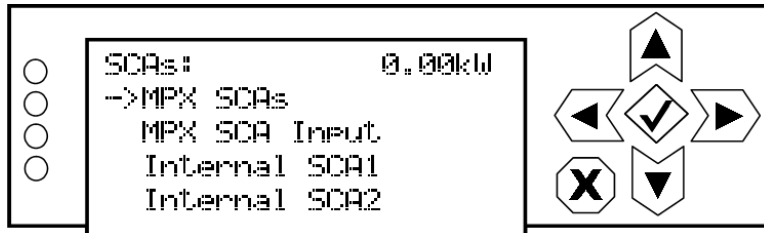

Use the up and down buttons to move the cursor to the desired SCA setting and then press the right button to enable editing of the parameter. [Figure 3.2.65](#) shows the editing screens for the SCA Settings menu. Within any of the editing screens, use the up and down buttons to edit or toggle a parameter value, noting the minimum and maximum limitations indicated at the bottom of the display. When complete, press the accept (checkmark) button to save the change. Press the cancel (X) button to discard changes and return to the previous menu.

If you select Internal SCA1 or Internal SCA2, there is a sub-menu that contains additional SCA settings (see [Figure 3.2.66](#) on page 3.2.85).

Figure 3.2.65: SCA Settings editing screens

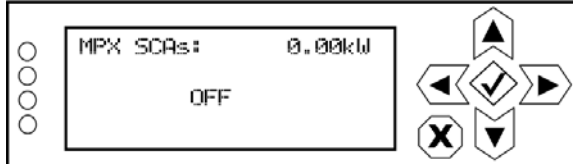

Use the up and down buttons to select ON or OFF, then press the accept (checkmark) button to save the change. Press the cancel (X) button to discard changes and return to the previous menu. Default setting is OFF.

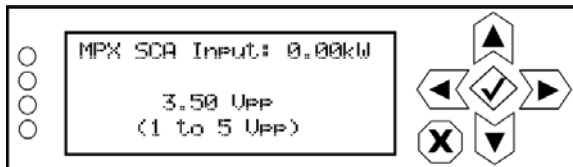

Use the up and down buttons to select a level between 1 and 5 V peak-to-peak (in 0.01 V increments), then press the accept (checkmark) button to save the change. Press the cancel (X) button to discard changes and return to the previous menu. Default level is 3.5 V pp.

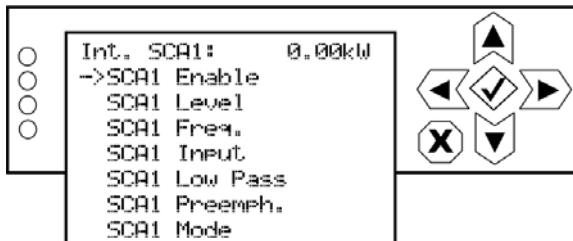

Use the up and down buttons to select the desired parameter for editing. See [Figure 3.2.66](#) on page 3.2.85 for more details. Press the accept (checkmark) button to enter the sub-menu for that parameter. Press the cancel (X) button to return to the previous menu.

Figure 3.2.66: Internal SCA1 and SCA2 editing screens

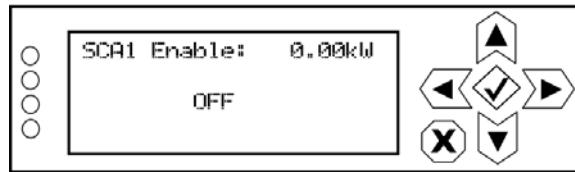

Use the up and down buttons to select ON or OFF, then press the accept (checkmark) button to save the change. Press the cancel (X) button to discard changes and return to the previous menu. Default setting is OFF.

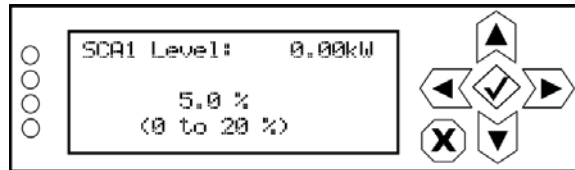

Use the up and down buttons to select a level between 0 and 20%, then press the accept (checkmark) button to save the change. Press the cancel (X) button to discard changes and return to the previous menu. Default level is 5.0%.

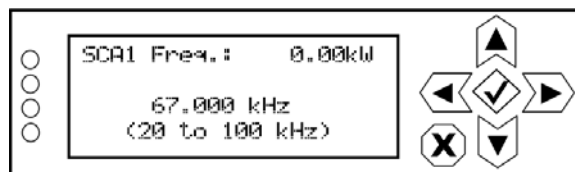

Use the up and down buttons to select a frequency between 20 and 100 kHz, then press the accept (checkmark) button to save the change. Press the cancel (X) button to discard changes and return to the previous menu. Default level is 67 kHz; typical setting is 67 kHz or 92 kHz.

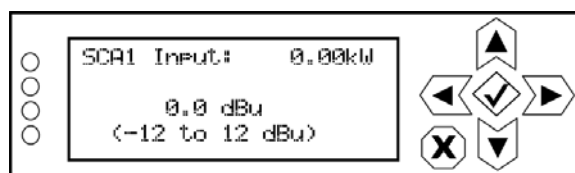

Use the up and down buttons to select a level between -12 and 12 dBu, then press the accept (checkmark) button to save the change. Press the cancel (X) button to discard changes and return to the previous menu. Default level is 0 dBu.

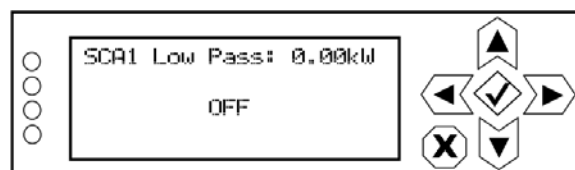

Use the up and down buttons to select ON or OFF, then press the accept (checkmark) button to save the change. Press the cancel (X) button to discard changes and return to the previous menu. Default setting is OFF.

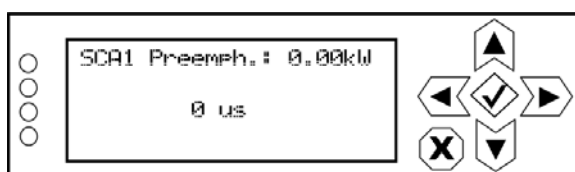

Use the up and down buttons to select a pre-emphasis of 0 us, 50 us, 75 us or 150 us, then press the accept (checkmark) button to save the change. Press the cancel (X) button to discard changes and return to the previous menu. Default level is 0 us.

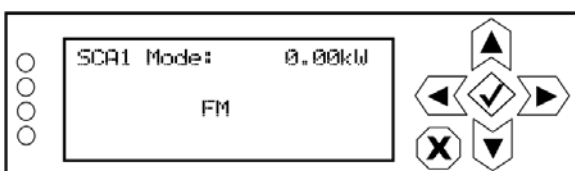

Use the up and down buttons to select FM or DSB-SC, then press the accept (checkmark) button to save the change. Press the cancel (X) button to discard changes and return to the previous menu. Default setting is FM.

RDS SETTINGS. When you select RDS Settings from the Preset editing options screen, you can edit various RDS parameters (see [Figure 3.2.67](#)).

Figure 3.2.67: RDS Settings menu

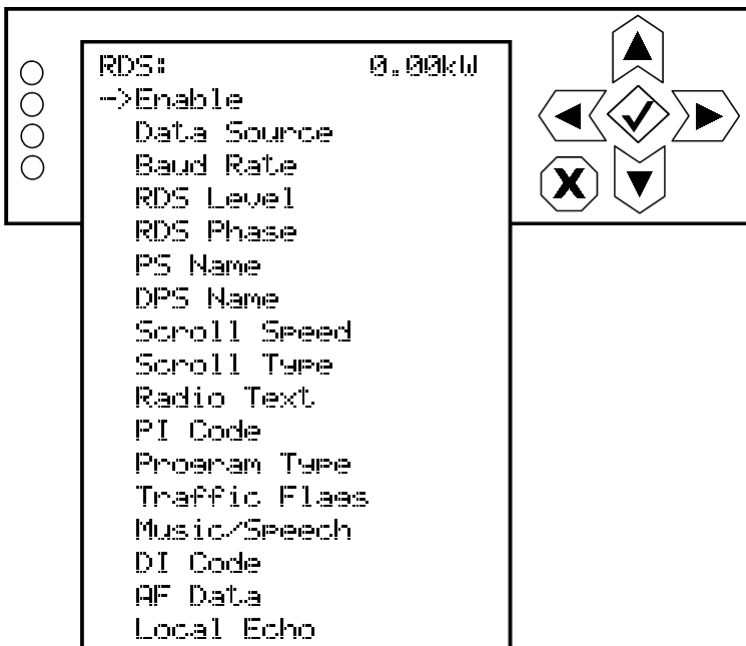

Use the up and down buttons to move the cursor to the desired RDS setting and then press the right button to enable editing of the parameter. [Figure 3.2.68 on page 3.2.87](#) and [Figure 3.2.69 on page 3.2.88](#) show all the editing screens for the RDS Settings menu. Within any of the editing screens, use the arrow buttons to edit or toggle a parameter value, noting the minimum and maximum limitations indicated at the bottom of the display (as applicable). When complete, press the accept (checkmark) button to save the change. Press the cancel (X) button to discard changes and return to the previous menu.

If you select DI Code (see [Figure 3.2.70 on page 3.2.89](#)) or AF Data (see [Figure 3.2.72 on page 3.2.90](#)), there are associated sub-menus that contain additional setting options.

Figure 3.2.68: RDS Settings editing screens (1 of 3)

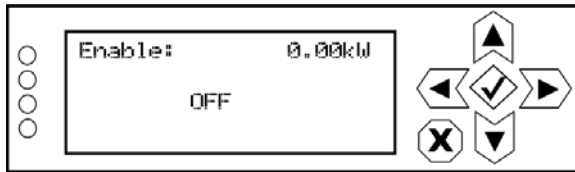

Use the up and down buttons to select ON or OFF, then press the accept (checkmark) button to save the change. Press the cancel (X) button to discard changes and return to the previous menu. Default setting is OFF.

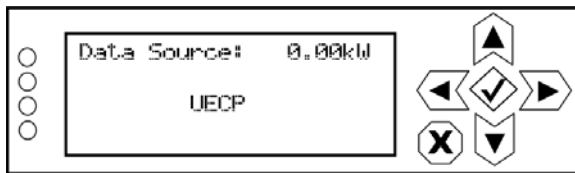

Use the up and down buttons to select Select Internal, ASCII, Ext. UECP, ASCII Over IP, or UECP Over IP, then press the accept (checkmark) button to save the change. Press the cancel (X) button to discard changes and return to the previous menu. Default setting is UECP.

NOTE: For an ASCII Over IP data source, RDS information should be sent to the IP address of the GV5/GV3.5, port 7005.

NOTE: For title/artist functionality, the GV5/GV3.5 supports the radiotext (RT) data type, using the UECP or Ext. ASCII data source.

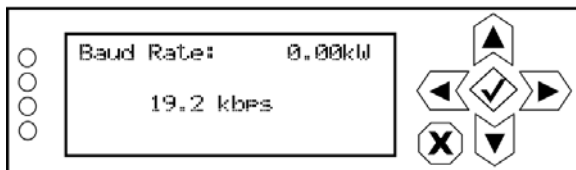

Use the up and down buttons to select Select 150 bps, 300 bps, 600 bps, 1.2 kbps, 2.4 kbps, 4.8 kbps, 9.6 kbps, 19.2 kbps, 38.4 kbps, 57.6 kbps or 115.2 kbps, then press the accept (checkmark) button to save the change. Press the cancel (X) button to discard changes and return to the previous menu. Default baud rate is 19.2 kbps.

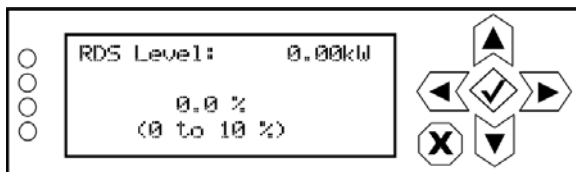

Use the up and down buttons to select a level between 0 and 10% (in 0.1% increments), then press the accept (checkmark) button to save the change. Press the cancel (X) button to discard changes and return to the previous menu. Default level is 0.0%.

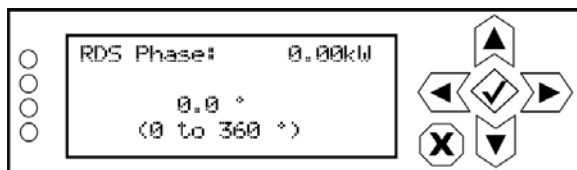

Use the up and down buttons to select a phase angle between 0 and 360 degrees (in 0.1 degree increments), then press the accept (checkmark) button to save the change. Press the cancel (X) button to discard changes and return to the previous menu. Default level is 0.0 degrees.

Figure 3.2.69: RDS Settings editing screens (2 of 3)

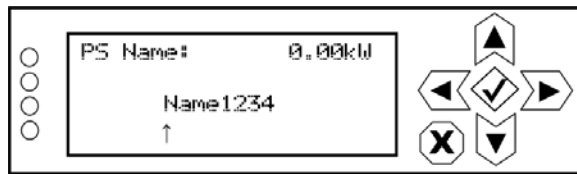

Enter an 8-character name. Use the right and left arrows to move the cursor to the desired character. Use the up and down arrows to edit the character, then press the accept (checkmark) button to save the change. Press the cancel (X) button to discard changes and return to the previous menu.

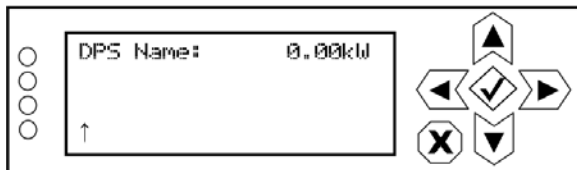

Enter a name. Use the right and left arrows to move the cursor to the desired character. Use the up and down arrows to edit the character, then press the accept (checkmark) button to save the change. Press the cancel (X) button to discard changes and return to the previous menu.

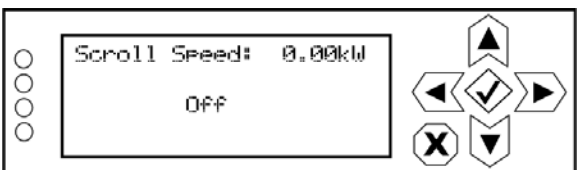

Use the up and down arrows to select Off, Fast or Slow, then press the accept (checkmark) button to save the change. Press the cancel (X) button to discard changes and return to the previous menu. The default selection is Off.

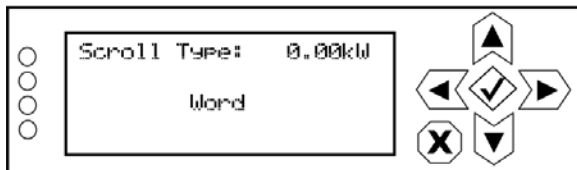

Use the up and down arrows to select Word or Character, then press the accept (checkmark) button to save the change. Press the cancel (X) button to discard changes and return to the previous menu. The default selection is Word.

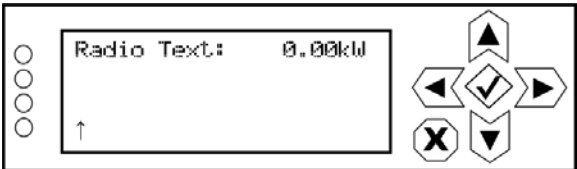

Enter a name. Use the right and left arrows to move the cursor to the desired character. Use the up and down arrows to edit the character, then press the accept (checkmark) button to save the change. Press the cancel (X) button to discard changes and return to the previous menu.



Use the up and down arrows to select a hex value between 0x0000 and 0xFFFF, then press the accept (checkmark) button to save the change. Press the cancel (X) button to discard changes and return to the previous menu. The default hex value is 0x0000.

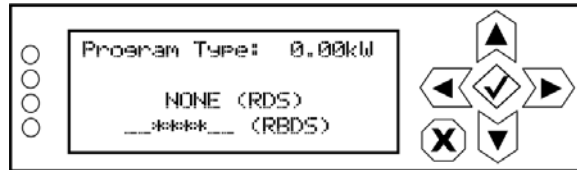

Use the up and down arrows to select the program type from the various options, then press the accept (checkmark) button to save the change. Press the cancel (X) button to discard changes and return to the previous menu. The default selection is NONE.

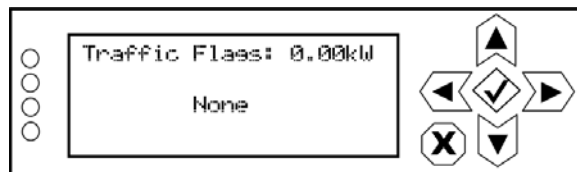

Use the up and down arrows to select None, TA/TP, TP or TA, then press the accept (checkmark) button to save the change. Press the cancel (X) button to discard changes and return to the previous menu. The default selection is NONE.

Figure 3.2.70: RDS Settings editing screens (3 of 3)

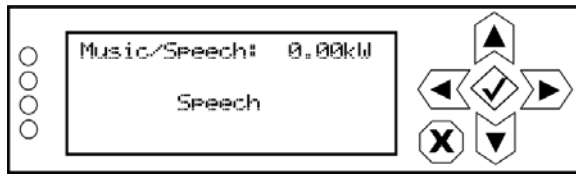

Use the up and down arrows to select Music or Speech, then press the accept (checkmark) button to save the change. Press the cancel (X) button to discard changes and return to the previous menu. The default selection is Speech.

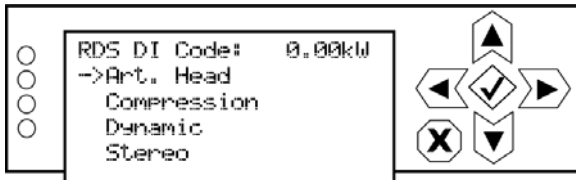

Use the up and down buttons to select the desired parameter for editing. See [Figure 3.2.70 on page 3.2.89](#) for more details. Press the accept (checkmark) button to enter the sub-menu for that parameter. Press the cancel (X) button to return to the previous menu.

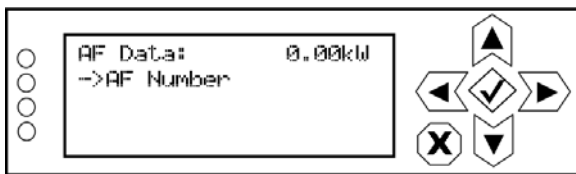

Use the up and down buttons to select AF Number for editing. See [Figure 3.2.72 on page 3.2.90](#) for more details. Press the accept (checkmark) button to enter the sub-menu for that parameter. Press the cancel (X) button to return to the previous menu.

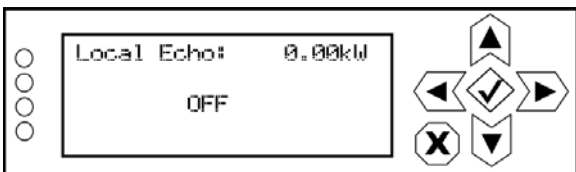

Use the up and down arrows to select ON or OFF, then press the accept (checkmark) button to save the change. Press the cancel (X) button to discard changes and return to the previous menu. The default selection is OFF.

Figure 3.2.71: DI Code editing screens

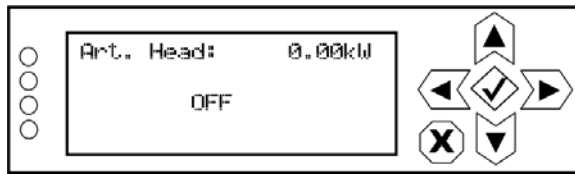

Use the up and down arrows to select ON or OFF, then press the accept (checkmark) button to save the change. Press the cancel (X) button to discard changes and return to the previous menu. The default selection is OFF.

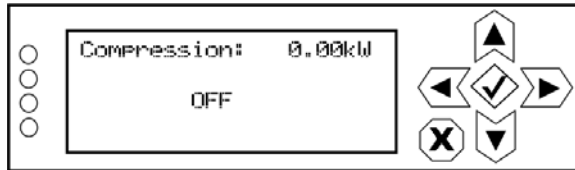

Use the up and down arrows to select ON or OFF, then press the accept (checkmark) button to save the change. Press the cancel (X) button to discard changes and return to the previous menu. The default selection is OFF.

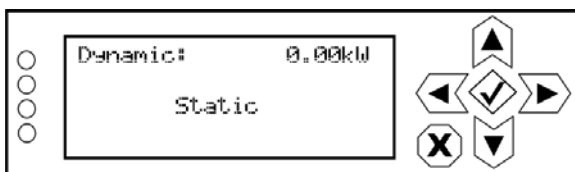

Use the up and down arrows to select Dynamic or Static, then press the accept (checkmark) button to save the change. Press the cancel (X) button to discard changes and return to the previous menu. The default selection is Static.

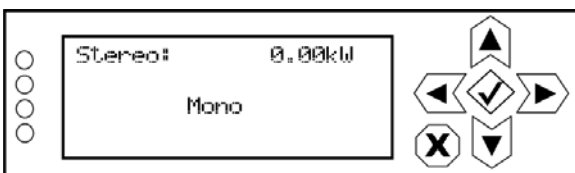

Use the up and down arrows to select Stereo or Mono, then press the accept (checkmark) button to save the change. Press the cancel (X) button to discard changes and return to the previous menu. The default selection is Mono.

Figure 3.2.72: AF Data editing screen

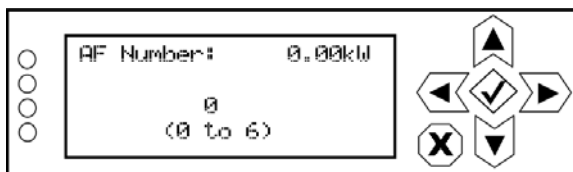

Use the up and down arrows to select the number of alternate frequencies (between 0 and 6), then press the accept (checkmark) button to save the change. Press the cancel (X) button to discard changes and return to the previous menu. The default number is 0.

LIMITER SETTINGS. When you select Limiter Settings from the Preset editing options screen, you can edit various limiter parameters (see [Figure 3.2.73](#)).

Figure 3.2.73: Limiter Settings menu

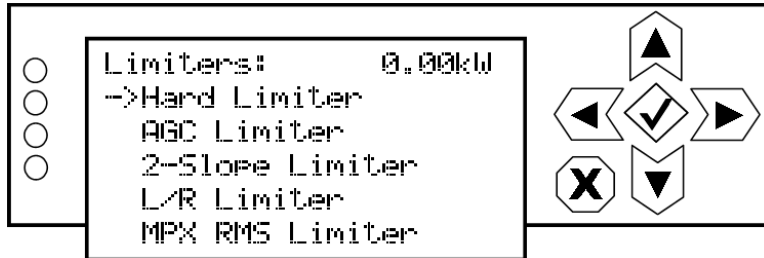

Use the up and down buttons to move the cursor to the desired limiter and then press the right button to enter the associated sub-menu for:

- ❖ Hard Limiter (see [Figure 3.2.74 on page 3.2.92](#))
- ❖ AGC Limiter (see [Figure 3.2.75 on page 3.2.92](#))
- ❖ 2-Slope Limiter (see [Figure 3.2.76 on page 3.2.93](#))
- ❖ L/R Limiter (see [Figure 3.2.77 on page 3.2.94](#))
- ❖ MPX RMS Limiter (see [Figure 3.2.78 on page 3.2.95](#))

Within a sub-menu, use the up and down buttons to move the cursor to the desired limiter setting and then press the right button to enter the associated editing screen. Within any of the editing screens, use the arrow buttons to edit or toggle a parameter value, noting the minimum and maximum limitations indicated at the bottom of the display (as applicable). When complete, press the accept (checkmark) button to save the change. Press the cancel (X) button to discard changes and return to the previous menu.

Figure 3.2.74: Hard Limiter sub-menu and editing screens

Use the up and down arrows to select ON or OFF, then press the accept (checkmark) button to save the change. Press the cancel (X) button to discard changes and return to the previous menu. The default selection is OFF.

Use the up and down arrows to select a limit between 0 and 160%, then press the accept (checkmark) button to save the change. Press the cancel (X) button to discard changes and return to the previous menu. The default limit is 160%.

Figure 3.2.75: AGC Limiter sub-menu and editing screens

Use the up and down arrows to select ON or OFF, then press the accept (checkmark) button to save the change. Press the cancel (X) button to discard changes and return to the previous menu. The default selection is OFF.

Use the up and down arrows to select a limit between 0 and 160%, then press the accept (checkmark) button to save the change. Press the cancel (X) button to discard changes and return to the previous menu. The default limit is 120%.

Use the up and down arrows to select a time constant between 0 and 1000 ms (1 s), then press the accept (checkmark) button to save the change. Press the cancel (X) button to discard changes and return to the previous menu. The default selection is 300 ms.

Figure 3.2.76: 2-Slope Limiter sub-menu and editing screens

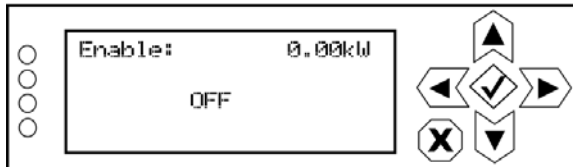
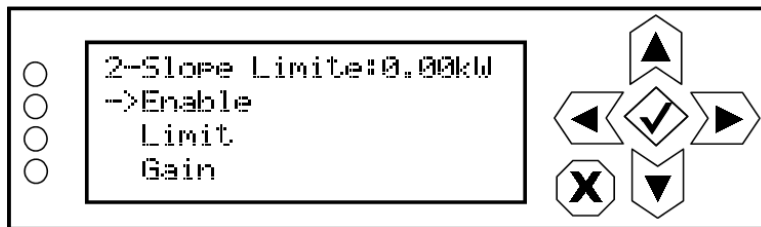

Use the up and down arrows to select ON or OFF, then press the accept (checkmark) button to save the change. Press the cancel (X) button to discard changes and return to the previous menu. Default selection is OFF.

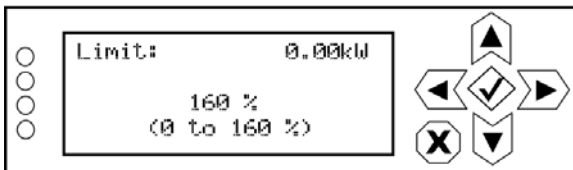

Use the up and down arrows to select a limit between 0 and 160%, then press the accept (checkmark) button to save the change. Press the cancel (X) button to discard changes and return to the previous menu. Default limit is 160%.

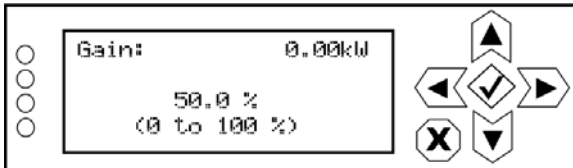

Use the up and down arrows to select a gain between 0 and 100%, then press the accept (checkmark) button to save the change. Press the cancel (X) button to discard changes and return to the previous menu. Default gain is 50%.

Figure 3.2.77: L/R Limiter sub-menu and editing screens

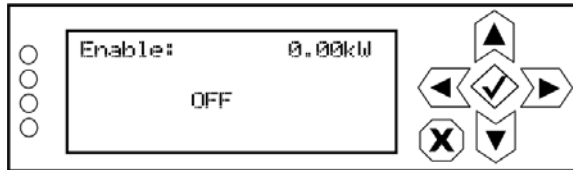
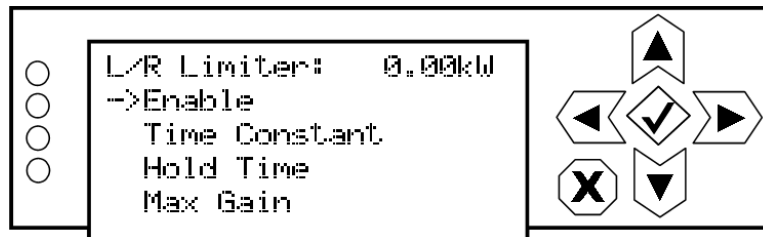

Use the up and down arrows to select ON or OFF, then press the accept (checkmark) button to save the change. Press the cancel (X) button to discard changes and return to the previous menu. Default selection is OFF.

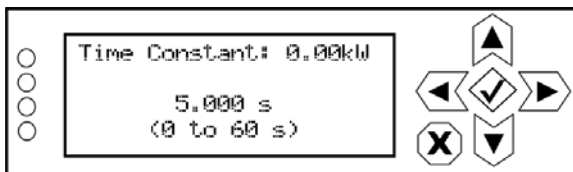

Use the up and down arrows to select a time constant between 0 and 60 s, then press the accept (checkmark) button to save the change. Press the cancel (X) button to discard changes and return to the previous menu. Default time constant is 5.000 s.

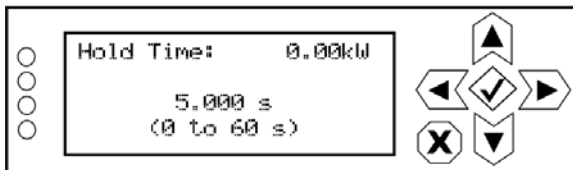

Use the up and down arrows to select a hold time between 0 and 60 s, then press the accept (checkmark) button to save the change. Press the cancel (X) button to discard changes and return to the previous menu. Default hold time is 5.000 s.

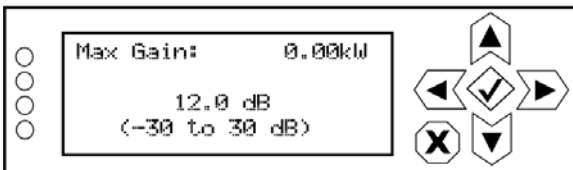

Use the up and down arrows to select a maximum gain between -30 and 30 dB, then press the accept (checkmark) button to save the change. Press the cancel (X) button to discard changes and return to the previous menu. Default gain is 12.0 dB.

Figure 3.2.78: MPX RMS Limiter sub-menu and editing screens

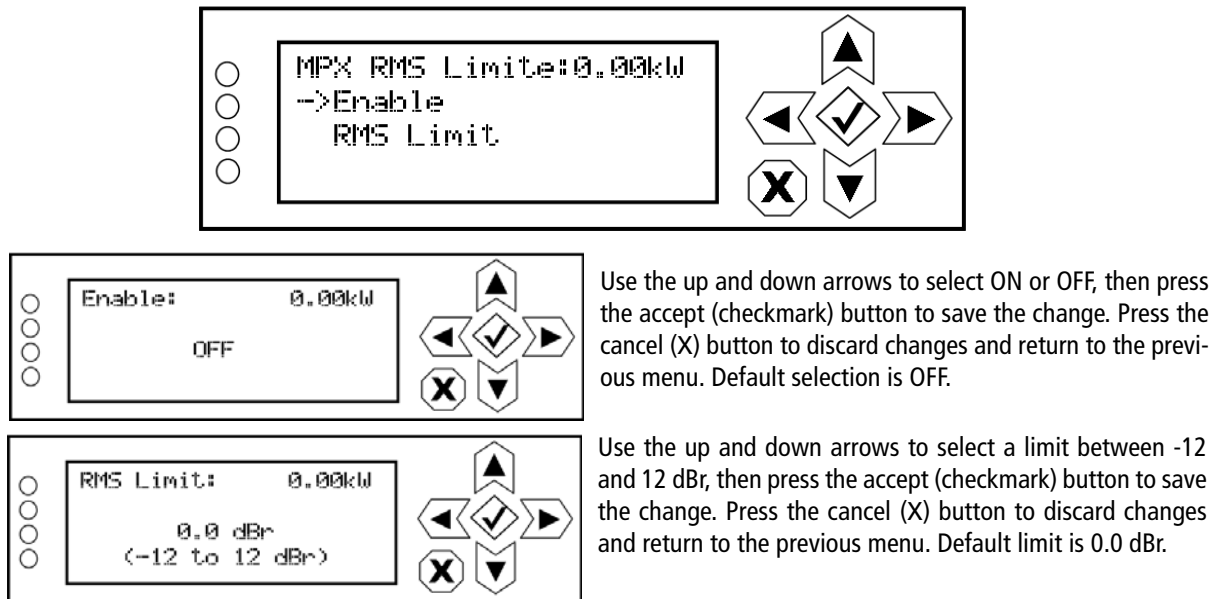

MOD Loss. When you select Mod Loss (modulation loss) from the Preset editing options screen, you can edit the parameters related to a loss of modulation (see [Figure 3.2.79](#)).

Figure 3.2.79: Mod Loss menu

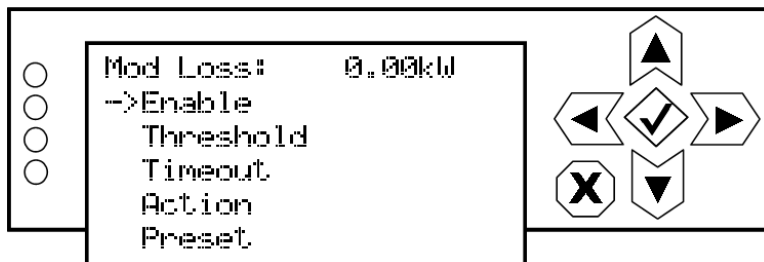

Use the up and down buttons to move the cursor to the desired mod (modulation) loss menu item and then press the right button to enable editing of the item. [Figure 3.2.80](#) shows all the editing screens for the Mod Loss menu. Within any of the editing screens, use the up and down buttons to edit a parameter value, noting the minimum and maximum limitations indicated at the bottom of the display (as applicable). When complete, press the accept (checkmark) button to save the change. Press the cancel (X) button to discard changes and return to the previous menu.

See [Configuring a Mod Loss Backup Preset, on page 3.4.4](#) for detailed instructions.

Figure 3.2.80: Mod Loss editing screens

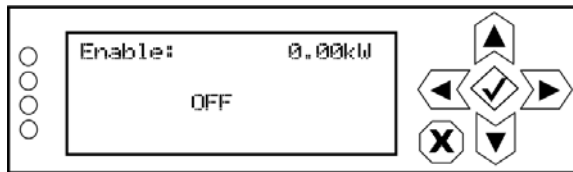

Determines whether the audio loss feature is used. Use the up and down arrows to select ON (enable) or OFF (disable), then press the accept (checkmark) button to save the change. Press the cancel (X) button to discard changes and return to the previous menu. Default selection is OFF.

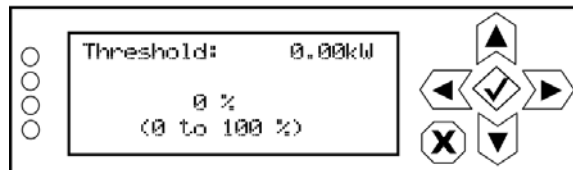

Sets the modulation threshold below which the transmitter will take action. Use the up and down arrows to select a threshold between 0 and 100% (adjustable in 1% steps), then press the accept (checkmark) button to save the change. Press the cancel (X) button to discard changes and return to the previous menu. Default threshold is 0%.

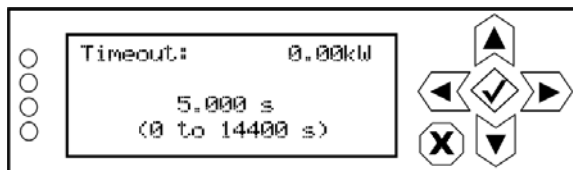

Sets the time period of low modulation (based on the threshold setting) after which the transmitter will take action. Use the up and down arrows to select a value between 0 and 14400 seconds (240 minutes) (in 0.05 s increments), then press the accept (checkmark) button to save the change. Press the cancel (X) button to discard changes and return to the previous menu. Default timeout is 0 s.

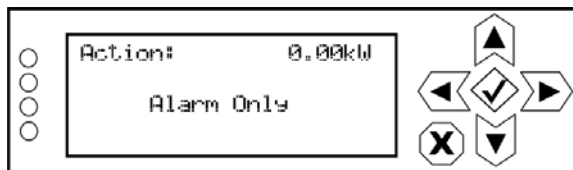

Determines the action taken by the transmitter when the modulation has been below the threshold for the timeout period. Use the up and down arrows to select Alarm Only, Switch Preset or RF Inhibit, then press the accept (checkmark) button to save the change. Press the cancel (X) button to discard changes and return to the previous menu. Default setting is Alarm Only.

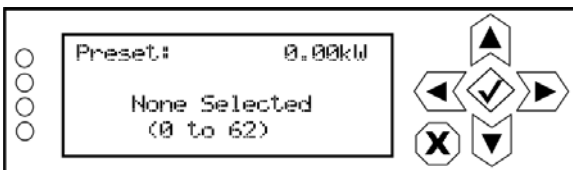

Determines the preset that becomes active after a modulation loss if the mod loss action is set to Switch Preset. Use the up and down arrows to select None Selected or Preset 1 to 62, then press the accept (checkmark) button to save the change. Press the cancel (X) button to discard changes and return to the previous menu. Default setting is None Selected.

AUDIO DELAY. When you select Audio Delay from the Preset editing options screen, you can edit or disable the audio delay period (see [Figure 3.2.81](#)).

Figure 3.2.81: Audio Delay menu

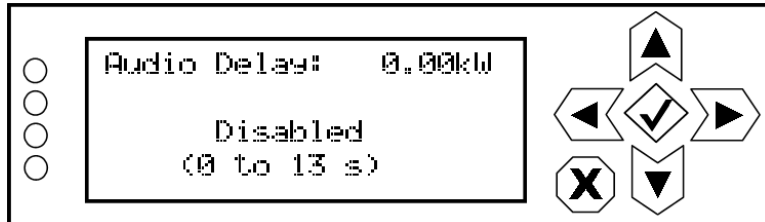

Use the up and down buttons to change the audio delay setting between disabled (= 0 s) and any time period to a maximum of 13 seconds (in 1 us steps), then press the accept (checkmark) button to save the change. Press the cancel (X) button to discard changes and return to the previous menu.

COPY ANOTHER PRESET. When you select Copy Another Preset from the Preset editing options screen, you can copy the settings from another preset into the preset that is being edited (see [Figure 3.2.82](#)).

Figure 3.2.82: Copy Another Preset Screen

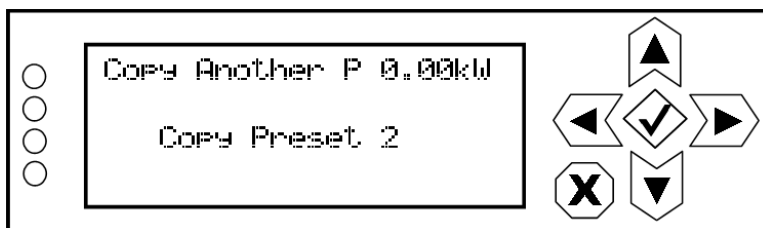

Use the up and down buttons to select the preset that you wish to copy to the selected preset for editing (e.g., Copy Active Preset, Copy Preset 2, etc.) or select Cancel. Press the accept (checkmark) button to save the change. Press the cancel (X) button to discard changes and return to the previous menu.

Resetting Alarms

You can attempt to reset any latching transmitter alarms that are holding the transmitter in an “off-air” state using the remote AUI’s Reset button (see [Resetting Alarms, on page 3.2.100](#)) or using the controller’s UI display (see [Resetting Alarms - Using the Controller UI](#)).

Resetting Alarms - Using the Controller UI

When you select Reset Alarms from the Main Menu, you can attempt to reset latched protection circuits in the GV5/GV3.5 (see [Figure 3.2.83](#)). If the alarm condition has been cleared, the alarm indication on the View Alarms screen should disappear.

Figure 3.2.83: Reset Alarms Screen

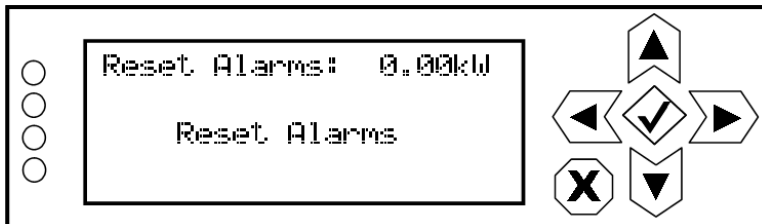

Use the up and down buttons to toggle between Reset Alarms and Cancel. Press the accept (checkmark) button to save the change. Press the cancel (X) button to return to the previous menu.

Viewing Transmitter Status - using the AUI

You can view the GV5/GV3.5's operational status using the [Transmitter Status page](#) - see Figure 3.2.84. This page shows current active alarms and status to aid in fault diagnosis. To view the [Transmitter Status page](#), select Status from the AUI bottom banner. Click X to return to the home page.

You can also use the controller UI to view active alarms (see [Transmitter Alarms and Log - Using the Controller UI](#), on page 3.2.36).

This section includes the following topics:

- [Viewing Alarm Details](#), on page 3.2.100
- [Status Button Colour Indications](#), on page 3.2.100
- [Resetting Alarms](#), on page 3.2.100

Figure 3.2.84: Transmitter Status page

The screenshot displays the Transmitter Status page with the following data:

Date & Time	Transmitter	Exciter
Mon Jul 29 2013 13:16:26 Scheduler: Off	0 kW 98.00 MHz Reflected 1.00 W Set Point 5.00 kW Preset: Preset 1	Active Exciter: A FM Modulation: 0% to 160% (current at 9.00%)

Device	Alarm	Level
Controller	External Interlock Open	High (Red Triangle)
Exciter A	Analog Left Audio Low	Medium (Yellow Triangle)
Exciter A	Analog Right Audio Low	Medium (Yellow Triangle)

Bottom navigation bar includes: RF On, RF Off, Logged in as: Nautel, Menu, Status, Logs, Local/Remote, Reset, Log Out.

Viewing Alarm Details

The [Transmitter Status](#) page - see [Figure 3.2.84](#) on [page 3.2.99](#) displays a table that lists the active alarm details under the following columns:

- Device - identifies the alarms by their originating device (e.g., Controller, Exciter A, Rack, etc.)
- Alarm - identifies the type of alarm (alarm name).
- Level - identifies the severity level of the alarm (see below).

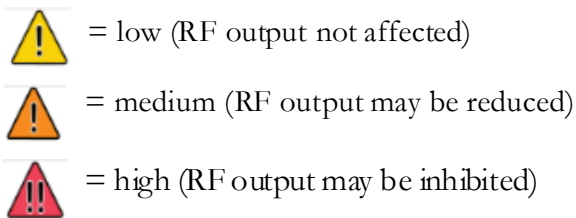

NOTE: When viewing alarms, cross-reference the alarm name, (which appears in the Alarm column of the Transmitter Status page) with Table 4.1.1 of the Troubleshooting Manual.

Status Button Colour Indications

- When the Status button is red, one or more active alarms are indicating that the transmitter may be in an 'off-air' state.
- When the Status button is amber, one or more active alarms are indicating that the transmitter is still 'on-air', but may be at reduced power.
- When the Status button is green, no alarms are being reported and the transmitter is operating normally.

Resetting Alarms

When an alarm is present, use the Reset button, at the bottom of any AUI screen, (see [Figure 3.2.85](#)) to clear any latching alarms that are holding the transmitter in an "off-air" state. If the offending alarm has cleared, then the transmitter should resume operation.

Figure 3.2.85: Reset Button



System Settings

Users can determine critical system configuration parameters using the AUI (see [System Settings - using the AUI](#)) or using the controller UI (see [System Settings - using the Controller UI](#), on page 3.2.113)

System Settings - using the AUI

The AUI's System Settings page (see [Figure 3.2.86](#)) is accessible from the Main Menu options. It contains the following options:

- [Reset](#), on page 3.2.102
- [Upgrade Software](#), on page 3.2.103
- [Exciter TCXO](#), on page 3.2.105
- [IBOC Settings](#), on page 3.2.106
- [Spectrum/Efficiency Optimizer](#), on page 3.2.108
- [Hardware Configuration](#), on page 3.2.109
- [FM Polarity](#), on page 3.2.111
- [Audio Input Calibration](#), on page 3.2.112

Figure 3.2.86: System Settings Page

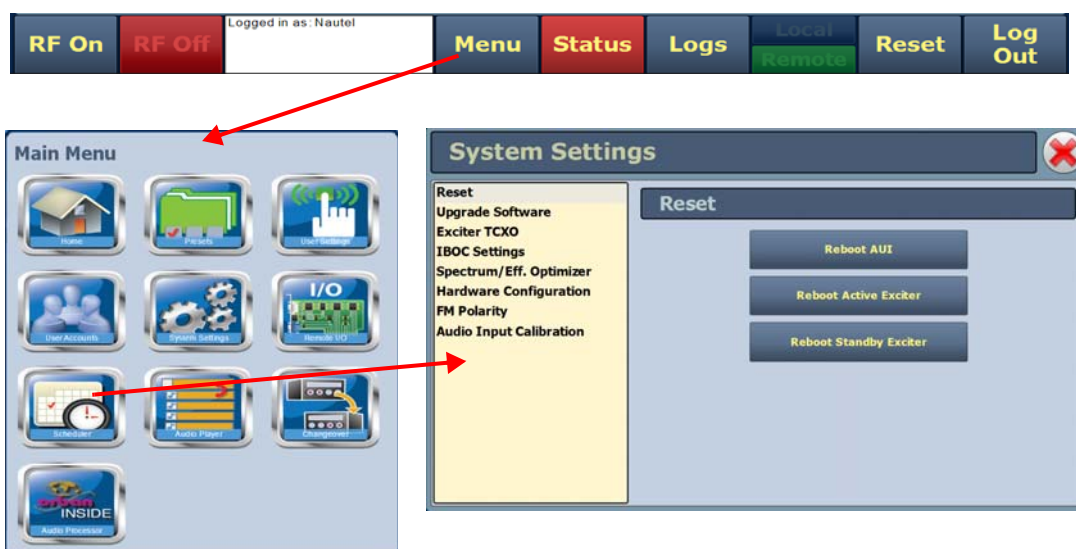

Reset

The Reset page (see [Figure 3.2.87](#)) allows users to reboot three items - the AUI, the active exciter and the standby exciter (if installed).

Figure 3.2.87: System Settings - Reset

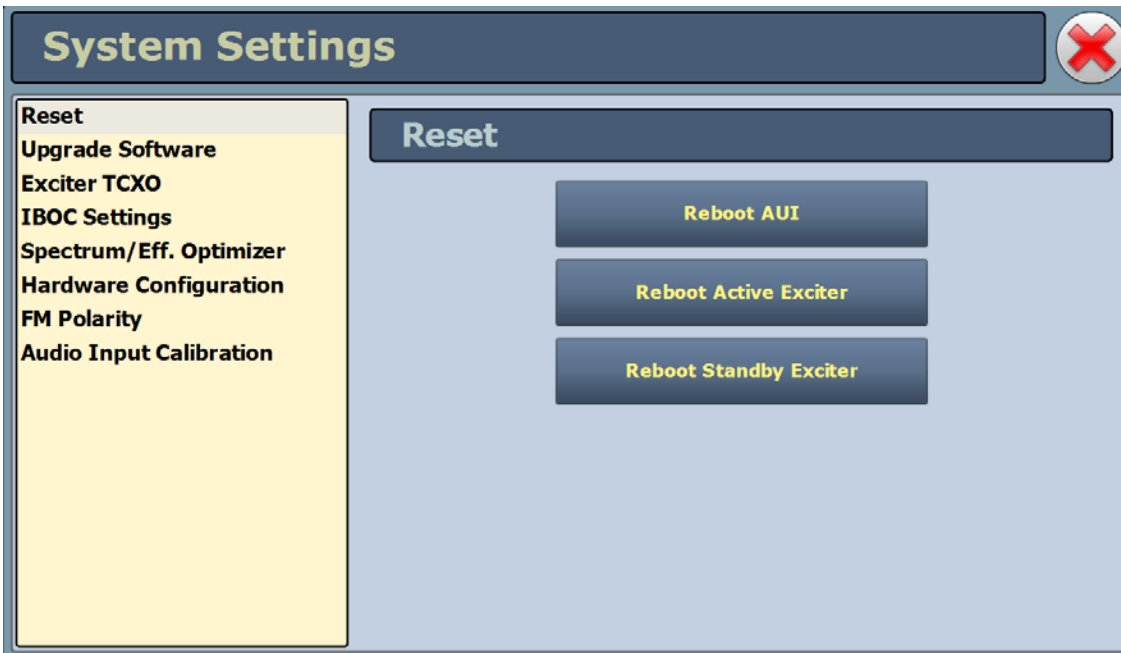

- To reset the AUI, press the Reboot AUI button. This will function with remote control enabled or disabled. After the reboot delay, you must log in to the AUI again to reset the ARM (see also [Exciter Power, on page 3.2.129](#)).
- To reset the active exciter, press the Reboot Active Exciter button, if the button is available (highlighted). NOTE: If the active exciter is reset, a brief interruption in transmitter operation will occur.
- To reset the standby exciter (for dual exciters), press the Reboot Standby Exciter button, if the button is available (highlighted).
- Press X in the upper, right corner to close this page and return to the Home page.

Upgrade Software

The Upgrade Software page (see [Figure 3.2.88](#)) allows for uploading a suite of software upgrade files (.tgz files) via remote connection. Navigate the page as described below. Note that users cannot add upgrade files via the local AUI touchscreen. For additional information on loading software, see [Upgrading Software, on page 3.4.1](#).

Figure 3.2.88: Upgrade Software page

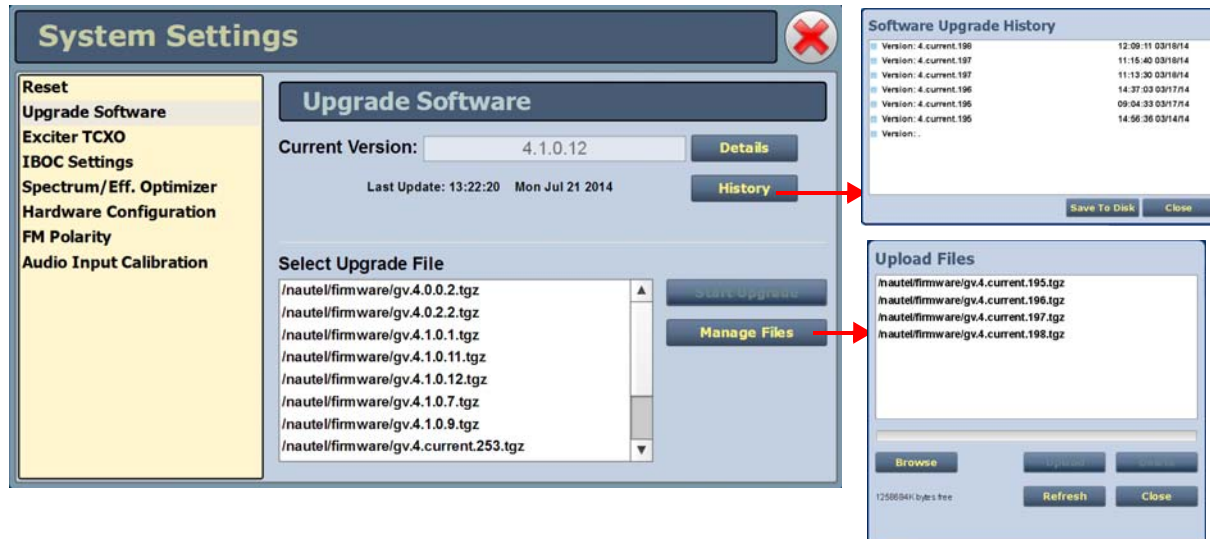

Select the Upgrade Software option from the left side of the System Settings page to open a related window on the right side of the page. The page consists of the following sections and buttons:

- Current Version: indicates the current software version.
- Select Upgrade File: displays the available upgrade files uploaded to the transmitter.
- Details: opens a window containing information about the installed software. If an upgrade file is selected, the screen shows a comparison between the installed version and the selected upgrade by component. Identical versions are shown in green; different versions are shown in red. You can also view the details of the previous upgrade by pressing the View Last Upgrade checkbox.
- History: displays a window containing a history of the upgrades to the software. Press the + button to maximize the details of the software. You can save this information to disk as a .txt file from the remote AUI.
- Start Upgrade: begins to upgrade the current software with the selected upgrade file.

- Manage Files (available through the remote AUI only): opens a window displaying the files you can upload to upgrade the software. You can add or delete files from this list using the Browse, Upload and Delete buttons in the window.

NOTE: Before performing a software upgrade, maximize the SBC's disk space by deleting the old .tgz files. Press the Manage Files button to display the Upload Files window, select the file(s) to delete, and press the Delete button.

Exciter TCXO

The Exciter TCXO page (see [Figure 3.2.89](#)) allows users to calibrate the internal clock to a user supplied external high precision 10 MHz clock reference (e.g. GPS synchronized 10 MHz clock). Once this external 10 MHz clock reference is connected, the 10MHz Int-Ext Offset field will display the difference between the internal and external frequencies (in ppm). Users can press the Start button to automatically calibrate the internal TCXO to the external reference source; equally, they can manually enter the measured internal-external offset value into the TCXO Offset Value field and press Apply.

If no external high precision 10 MHz clock reference is connected, but the actual transmitter carrier frequency is being measured with a calibrated external frequency counter, operators can manually offset the internal TCXO by entering the appropriate ppm difference in the TCXO Offset Value field. For example, if the frequency of the transmitter is 1 ppm too high, then a positive 1 ppm should be entered in the TCXO Offset Value field in order to compensate. Similarly, if the transmitter frequency is too low, enter a negative ppm value. After an adjustment is made, press Apply.

To calibrate another exciter, switch to that exciter and repeat the calibration.

Figure 3.2.89: AUI - Exciter TCXO calibration page

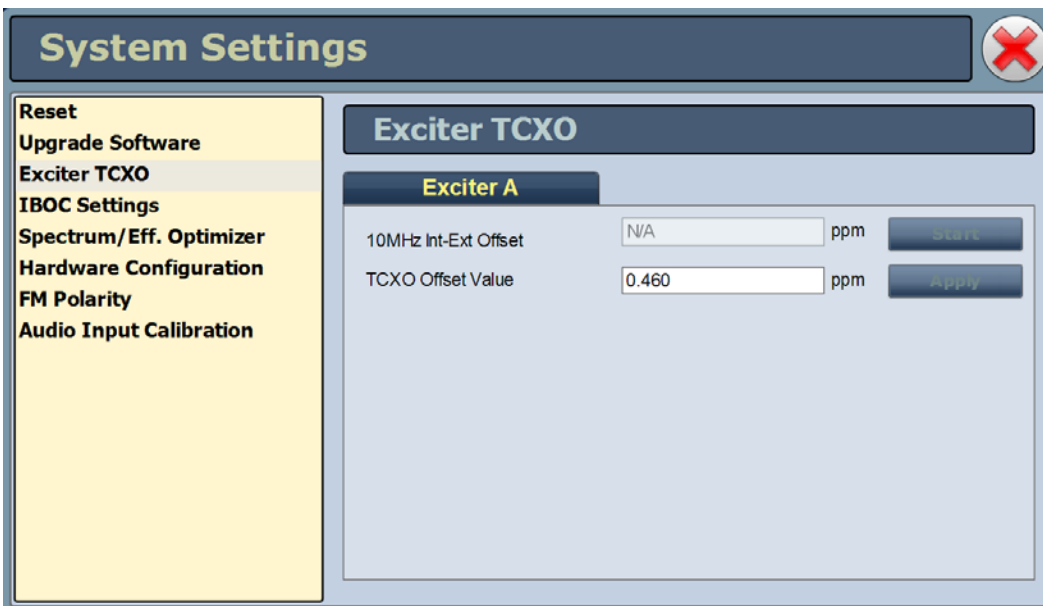

The screenshot shows a software interface titled "System Settings" with a red close button in the top right. On the left is a yellow sidebar with the following menu items: "Reset", "Upgrade Software", "Exciter TCXO" (highlighted), "IBOC Settings", "Spectrum/Eff. Optimizer", "Hardware Configuration", "FM Polarity", and "Audio Input Calibration". The main content area is titled "Exciter TCXO" and has a sub-tab for "Exciter A". It contains two input fields: "10MHz Int-Ext Offset" with a value of "N/A" and "ppm" unit, and "TCXO Offset Value" with a value of "0.460" and "ppm" unit. There are "Start" and "Apply" buttons next to each field.

NOTE: You can also adjust the exciter TCXO offset value and run a TCXO calibration from the controller UI (see [Setting Exciter TCXO Offset, on page 3.2.117](#)).

IBOC Settings

The IBOC Settings page (see [Figure 3.2.90](#)) allows users to establish Forward Tap Delay, FM+HD Low Inj Gain, FM+HD High Inj Gain and HD only system Gain levels. It also allows for an IBOC power calibration. Changes apply to the active exciter (A or B) only. To calibrate the other exciter, switch to the other exciter and repeat the change.

- Forward Tap Delay - Displays the time delay (in unit taps) between the forward path signal from the exciter and the reverse path signal into the exciter, fed back from the output of the transmitter. This value is factory set (to synchronize the phase of the forward and reverse signals so that pre-correction can operate properly) and should not require any adjustment in the field.
- Auto-Find Gain - Press the Start button to automatically find the optimized gain while the transmitter is RF On and in the applicable preset mode/injection level.
- FM+HD Low Inj Gain - Applicable for FM+HD mode only (at -20 dBc to -15.1 dBc injection levels) and represents the starting/default gain applied to the forward path signal within the exciter at initial turn on/ramp-up.
- FM+HD High Inj Gain - Applicable for FM+HD mode only (at -15 dBc to -10 dBc injection level) and represents the starting/default gain applied to the forward path signal within the exciter at initial turn on/ramp-up.
- HD Gain - Applicable for HD mode only and represents the starting/default gain applied to the forward path signal within the exciter at initial turn on/ramp-up.
- IBOC Power Calibration - This calibration occurs at the factory and should not require any adjustment in the field. This calibration is performed in FM mode.
- Calibration Value - Displays the calibration of the exciter's measurement of the transmitter power.

Figure 3.2.90: System Settings - IBOC Settings

IBOC Settings	
Exciter A	
Forward Tap Delay	125.0
Auto-Find Gain	Start
FM+HD Low Inj Gain	0.5502
FM+HD High Inj Gain	0.5501
HD Gain	0.6502
IBOC Power Calibration	
Calibration Value	1.0776

NOTE: You can also establish IBOC settings using the controller UI (see [IBOC Settings](#), on page 3.2.78).

Spectrum/Efficiency Optimizer

The Spectrum/Eff. Optimizer page (see [Figure 3.2.91](#)) allows users to optimize the transmitter's spectrum and/or efficiency by adjusting the following parameters:

- Optimization Enabled - Select Yes or No. Selecting Yes allows the optimizer to adjust the PA voltage setting to maximize efficiency based on the transmitter output spectrum. Depending on other settings in this section, it may require other actions to maintain the transmitter's compliance.
- Reduce Digital Power If Required: Select Yes or No. Selecting Yes enables a reduction in injection level (digital power) if the spectrum mask requires it.
- Reduce Power Set-Point If Required: Select Yes or No. Selecting Yes enables a reduction in the transmitter power set-point if the spectrum mask requires it.
- Desired Mask Delta - Set the desired clearance (between -10 dB and 0 dB) from the spectral mask. The default setting is -1 dB, which will maintain a 1 dB clearance from the mask for maximum efficiency. This settings will not cause any reduction in output power.
- Required Mask Delta - Sets the value (between -10 db and 10 dB) that is considered to be absolutely required. If this level is exceeded, the digital power from the transmitter will be reduced if the PA voltage is at maximum. If the spectral mask still cannot be met and the setting for it is enabled, the transmitter power set-point will be reduced.

Figure 3.2.91: System Settings - Spectrum/Efficiency Optimizer

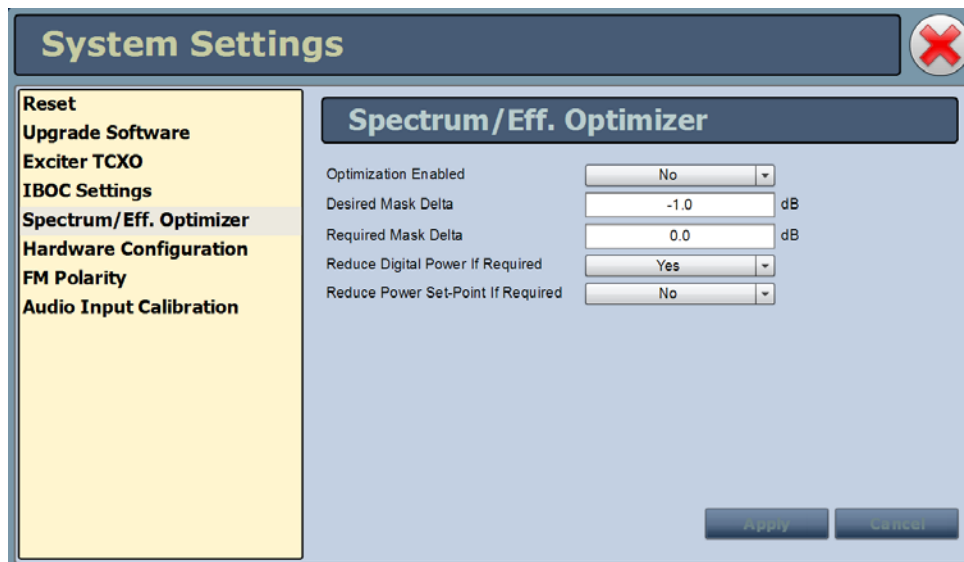

NOTE: You can also perform HD optimization using the controller UI (see [Optimizing HD Parameters](#), on page 3.2.118).

Hardware Configuration

The Hardware Configuration page (see [Figure 3.2.92](#)) allows configuration of the transmitter for any installed hardware that has optional variations (e.g, quantity of exciters or LVPS modules, fan speed) or is non-standard (e.g., UPS or audio processor).

NOTE: These settings are established at the factory based on the configuration that existed at time of shipping. Changes to these setting are only necessary if hardware is added or removed by the user. For all changes, press Apply to save the change or press Cancel to abort the change.

NOTE: You can also configure transmitter hardware using the controller UI (see [Configuring Installed Hardware, on page 3.2.120](#)).

- **Installed Exciter(s):** Select Single (A) or Dual (A/B), depending on the number of installed exciters. If you have upgraded your transmitter to dual exciters, you may have already been prompted to change this configuration.
- **LVPS Hardware:** Select Single LVPS: A or Dual LVPS: A/B, depending on the number of installed LVPS modules. The standard transmitter ships with dual LVPS modules.
- **LVPS Voltage:** Set the default LVPS voltage (between 35 and 53 V) used by the transmitter during normal operation. Under fault conditions, if the LVPS voltage requires an increase, the control system automatically increases the LVPS voltage, then decreases it back to the set value when the fault condition clears. This setting should not require adjustment.
- **Fan Speed:** Set the default speed of the transmitter's cooling fans to a percentage between 63 and 100% of the maximum speed during normal operation. The 63% default corresponds to a fan voltage of approximately 31 V. A 100% setting corresponds to approximately 48 V. Under fault conditions, the control system determines if an increase in fan speed is required and automatically adjusts the fan speed.

NOTE: The transmitter control function automatically adjusts fan speed to ensure adequate cooling based on all operating conditions. As a result this setting should not require adjustment. Increasing the fan speed will allow for cooler transmitter operation, but will also decrease efficiency and increase acoustic noise levels. A 20% reduction in fan speed can yield up to 5 dB improvement in acoustic noise from the transmitter, as well as decrease power consumption (i.e., utility costs) and extend the operating life of the cooling fans.

Figure 3.2.92: System Settings - Hardware Configuration

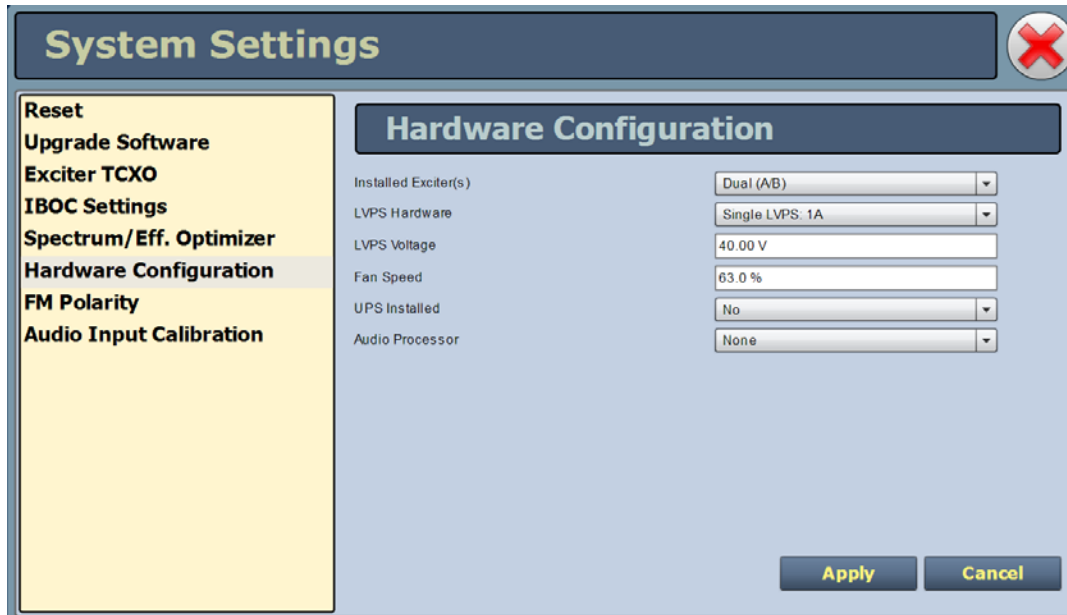

- UPS Installed: Select Yes if a UPS interface kit is installed in the transmitter to allow operation with an external, user-provided UPS. Select No if there is no UPS interface kit installed. If you have upgraded your transmitter with the UPS interface, you may have already been prompted to change this configuration.
- Audio Processor: See [Enabling and Operating the Orban Audio Processor, on page 3.2.196](#).

FM Polarity

The FM Polarity page (see [Figure 3.2.93](#)) allows users to invert the polarity of the frequency modulation (i.e., positive going modulation signal yields positive deviation; or positive going modulation signal yields negative deviation). Options are Normal (default) or Inverted.

Figure 3.2.93: FM Polarity

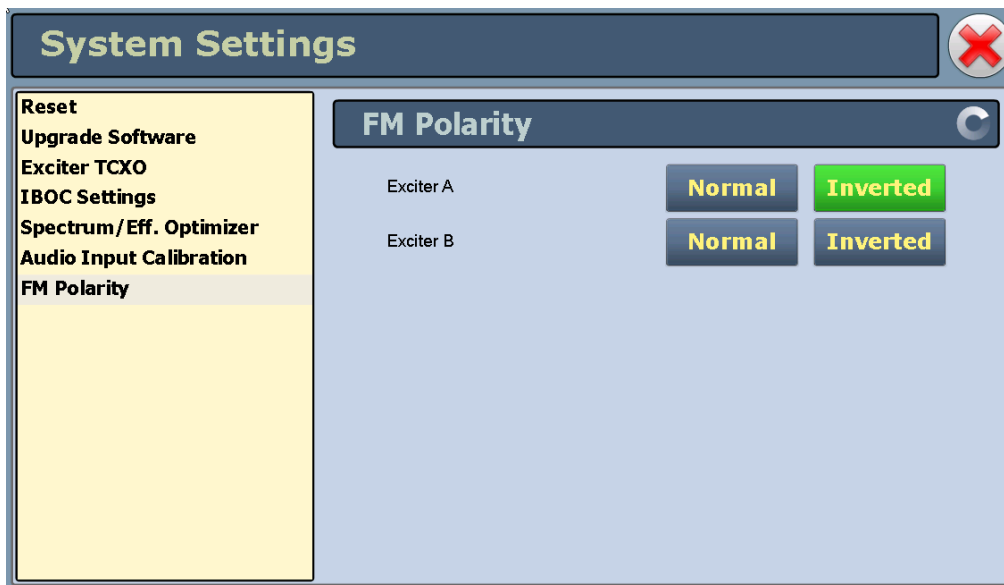

NOTE: You can also adjust FM polarity using the controller UI (see [FM Polarity](#), on page 3.2.124).

Audio Input Calibration

NOTE: Audio inputs are factory set using a high accuracy source and do not typically require user adjustment. Changes to factory calibrations could cause low or excessive modulation and non-compliance to strict regulatory limits. If you need to re-calibrate an audio input, make sure you have a reliable calibrated audio source.

The Audio Input Calibration page (see [Figure 3.2.94](#)) allows the user to calibrate analog and MPX (composite) audio inputs. The peak meter value of each calibrated audio input (analog left, analog right, MPX or MPX SCA, Int. SCA1 or Int. SCA2) that is applied will be displayed. Enter a valid calibration value and click Apply to save the changes. Press X in the upper, right corner to close this page and return to the home page.

Figure 3.2.94: Audio Input Calibration page

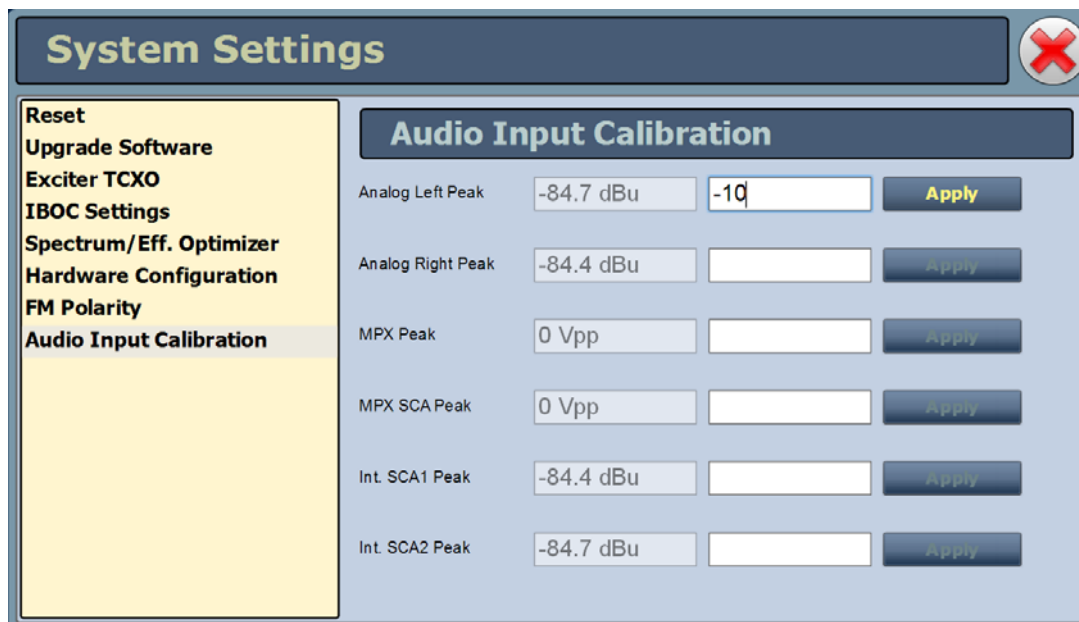

The screenshot shows the 'System Settings' application window with a close button (X) in the top right corner. The 'Audio Input Calibration' section is active, displaying a list of audio inputs with their current peak values and input fields for calibration. Each input has an 'Apply' button next to it.

Audio Input	Current Peak Value	Input Field	Action
Analog Left Peak	-84.7 dBu	-10	Apply
Analog Right Peak	-84.4 dBu		Apply
MPX Peak	0 Vpp		Apply
MPX SCA Peak	0 Vpp		Apply
Int. SCA1 Peak	-84.4 dBu		Apply
Int. SCA2 Peak	-84.7 dBu		Apply

NOTE: You can also perform audio input calibration using the controller UI (see [User Accounts](#), on page 3.2.130).

System Settings - using the Controller UI

WARNING! System settings are established at Nautel and should not require any adjustment. Making changes to these settings may void your warranty. Contact Nautel before making changes.

You can perform the following functions using the System Settings menu of the controller UI:

- [Resetting the Single-Board Computer \(SBC\) - see page 3.2.114](#)
- [Configuring SBC Watchdog - see page 3.2.114](#)
- [Updating Firmware - see page 3.2.115](#)
- [Adjusting Display Settings - see page 3.2.115](#)
- [Setting Exciter TCXO Offset - see page 3.2.117](#)
- [Optimizing HD Parameters - see page 3.2.118](#)
- [Configuring Installed Hardware - see page 3.2.120](#)
- [FM Polarity - see page 3.2.124](#)
- [Adjusting Factory Settings - see page 3.2.125](#)

NOTE: Changing values in the System Settings -> Factory Settings is not normally required, and should only be performed by trained personnel. Information on some of these sub-menus is not included in the manual. Contact Nautel for assistance.

Resetting the Single-Board Computer (SBC)

NOTE: An SBC reset is available using the controller UI. It can also be performed from the AUI, using the Reboot AUI button on the Reset page (see [Reset](#), on page 3.2.102). Once the SBC is reset, all users that were remotely connected (logged in) will be logged out.

From the controller UI, you can reset the SBC. To view the SBC Reset screen, select System Settings -> SBC Reset from the Main Menu (see [Figure 3.2.95](#)).

Figure 3.2.95: SBC Reset Screen

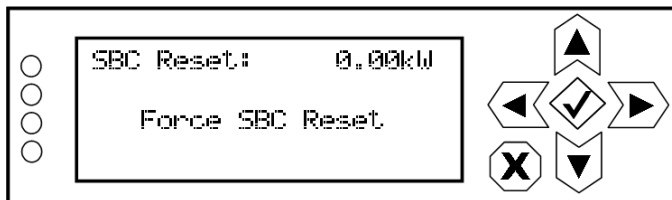

Use the up and down buttons to toggle between Force SBC Reset and Cancel. Press the accept (checkmark) button to save the change. If a reset is selected, it will occur immediately. Select Cancel or press X to abort the reset and return to the previous menu.

Configuring SBC Watchdog

NOTE: SBC watchdog configuration is only available using the controller UI.

From the controller UI, you can enable or disable the SBC watchdog feature. This feature, when enabled, monitors communication between the SBC and the DSP processor on the exciter/control PWB within the controller module. If communication is lost for more than 30 seconds, the transmitter will initiate an alarm and reboot the SBC. To view the SBC Watchdog screen, select System Settings -> SBC Watchdog from the Main Menu (see [Figure 3.2.96](#)).

Figure 3.2.96: SBC Watchdog Screen

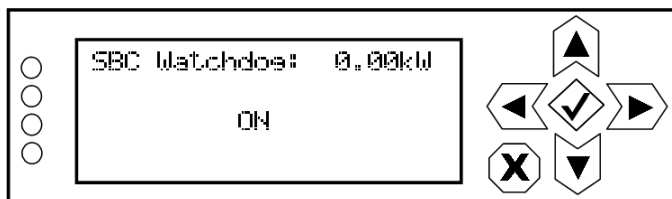

Use the up and down buttons to toggle between ON (enabled) and OFF (disabled). Press the accept (checkmark) button to save the change. Press cancel (X) to discard changes and return to the previous menu.

Updating Firmware

NOTE: A firmware update is available using the controller UI. It can also be performed from the AUI, using the Upgrade Software page in the System Settings menu (see [Upgrade Software, on page 3.2.103](#)). Once the SBC is reset, all users that were remotely connected (logged in) will be logged out.

From the controller UI, you can update firmware used in the transmitter. To perform a firmware update, select System Settings -> Firmware Update from the Main Menu (see [Figure 3.2.97](#)).

Figure 3.2.97: Firmware Update Screen

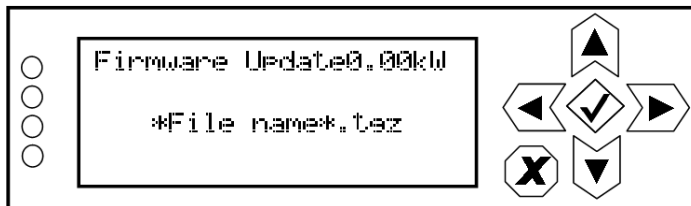

Adjusting Display Settings

NOTE: Controller UI display settings are only available using the controller UI.

From the controller's UI, you can configure the LCD display's contrast, brightness and backlight settings. To view the LCD Settings screen, select User Settings -> LCD Settings from the Main Menu (see [Figure 3.2.98](#)).

Figure 3.2.98: LCD Settings Menu

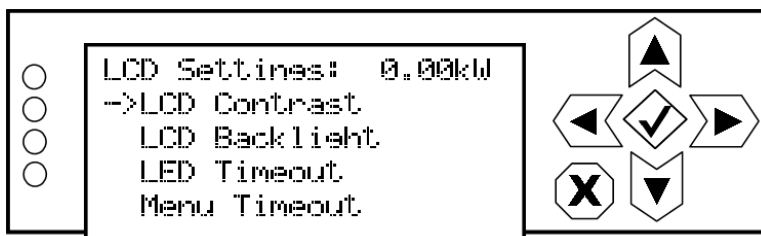

This menu has four sub-menu options:

- ❖ LCD Contrast - sets the display contrast.
- ❖ LCD Backlight - sets the brightness of the display's backlight during normal use.
- ❖ LED Timeout - sets a time delay, after a period of non-use, that the brightness of the display's backlight will dim. This feature can also be disabled.
- ❖ Menu Timeout - sets a time delay, after a period of non-use, that the front panel screen will revert back to the main menu.

Use the up and down buttons to move the cursor to the desired display setting and then press the right button to enable editing of the setting. [Figure 3.2.99 on page 3.2.116](#) shows the editing screens for the LCD Settings menu. Within any of the editing screens, use the up and down buttons to edit a setting. Press the accept (checkmark) button to save the change. Press cancel (X) to discard changes and return to the previous menu.

Figure 3.2.99: LCD Settings Editing Screens

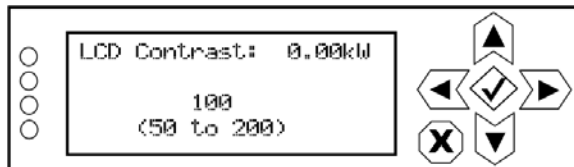

Select a value between 50 (lighter contrast) and 200 (darker contrast) (in increments of 5). Press the cancel (X) button to discard changes and return to the previous menu. Default setting is 100.

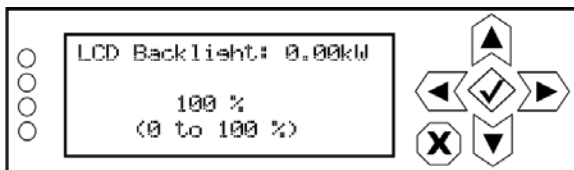

Select a value between 0 and 100% (in 5% increments). Press the cancel (X) button to discard changes and return to the previous menu. Default setting is 100%.

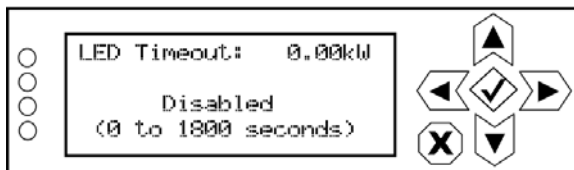

Select disabled (i.e., no timeout) or select a time period between 0 and 1800 seconds (30 minutes) (in 5 s increments). Press the cancel (X) button to discard changes and return to the previous menu. Default setting is 900 s (15 minutes).

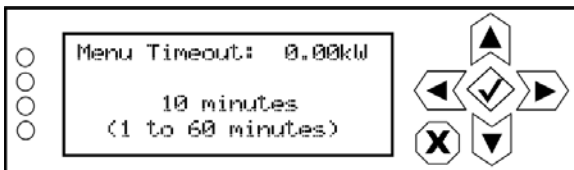

Select a time period between 1 and 60 minutes (in 1 minute increments). Press the cancel (X) button to discard changes and return to the previous menu. Default setting is 10 minutes.

Setting Exciter TCXO Offset

NOTE: You can also adjust the exciter TCXO offset value using the AUI (see [Exciter TCXO](#), on page 3.2.105).

To view the controller UI's Exc TCXO screens (see [Figure 3.2.100](#)), select System Settings -> Calibration from the Main Menu.

Figure 3.2.100: Exc TCXO screens

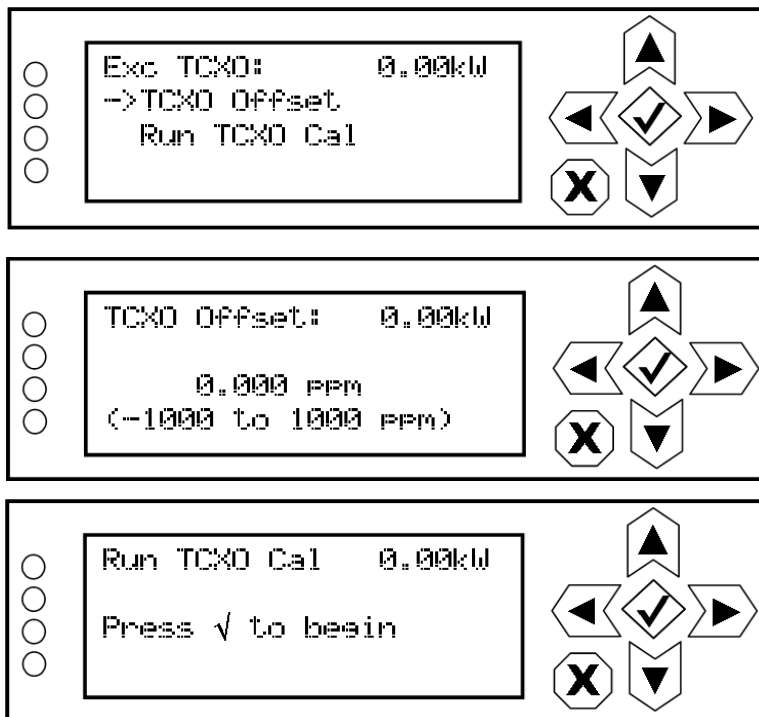

Use the up or down arrow to place the cursor next to TCXO Offset, then press the accept (checkmark) button to enter the TCXO Offset screen. Use the up and down arrows to set the TCXO offset value (in ppm) for the external 10 MHz source. When complete, press the accept (checkmark) button to save the change. Press cancel (X) to discard changes and return to the previous menu.

From the Exc TXCO menu, press the down arrow to place the cursor next to Run TCXO Cal, then press the accept (checkmark) button to enter the Run TCXO Cal screen. The calibration routine will begin when the external 10 MHz source is connected.

Optimizing HD Parameters

NOTE: You can also optimize the digital signal (spectrum mask) using the AUI (see [Spectrum/Efficiency Optimizer](#), on page 3.2.108).

From the controller's UI, you can enable and configure various HD signal parameters (e.g., injection level, TPO, etc.) in an attempt to optimize the digital signal's overall efficiency. To view the HD Optimizer screen, select User Settings -> HS Optimizer from the Main Menu (see [Figure 3.2.98](#)).

Figure 3.2.101: HD Optimizer Menu

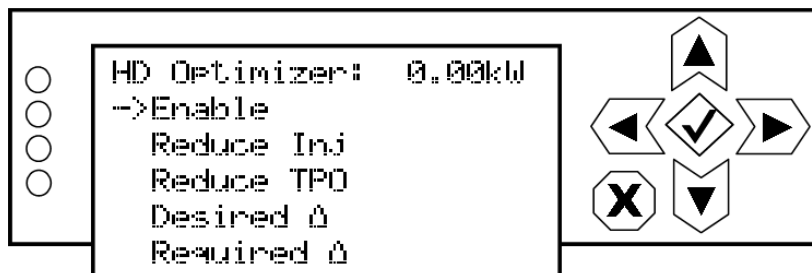

This menu has five sub-menu options:

- ❖ Enable
- ❖ Reduce Inj
- ❖ Reduce TPO
- ❖ Desired Delta
- ❖ Required Delta

Use the up and down buttons to move the cursor to the desired setting and then press the right button to enable editing of the setting. [Figure 3.2.102 on page 3.2.119](#) shows the editing screens for the HD Optimizer menu. Within any of the editing screens, use the up and down buttons to edit a setting. Press the accept (checkmark) button to save the change. Press cancel (X) to discard changes and return to the previous menu.

Figure 3.2.102: HD Optimizer Screens

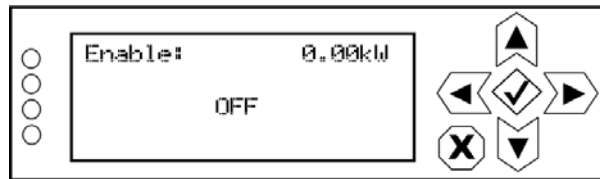

Select ON to allow the optimizer to adjust the PA voltage setting to maximize efficiency based on the transmitter output spectrum. Depending on other settings in this section, it may require other actions to maintain the transmitter's compliance. Select OFF to disable. When disabled, other HD Optimizer settings will have no effect.

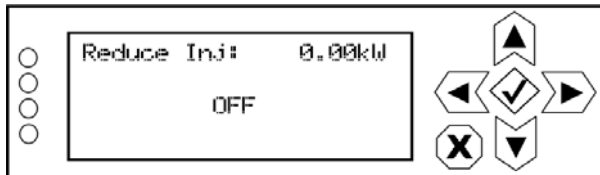

Select ON to enable a reduction in IBOC injection (digital power) if the spectrum mask requires it. Select OFF to disable this setting.

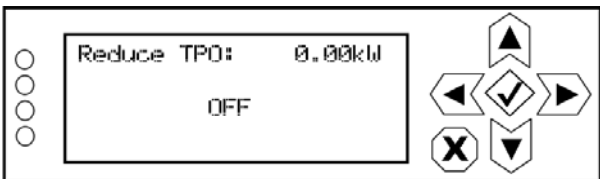

Select ON to enable a reduction in the power set-point if the spectrum mask requires it. Select OFF to disable this setting.

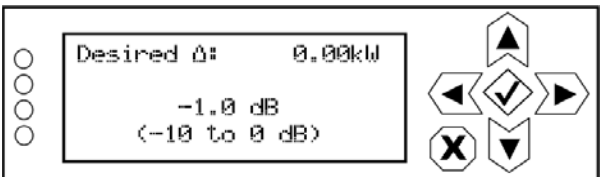

Set the desired clearance (between -10 dB and 0 dB) from the spectral mask. The default setting is -1 dB, which will maintain a 1 dB clearance from the mask for maximum efficiency. This settings will not cause any reduction in output power.

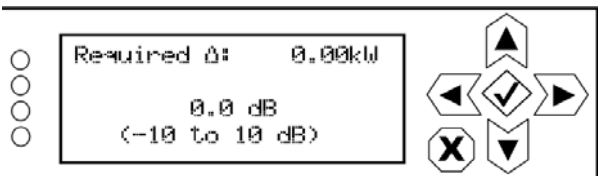

Sets the value (between -10 db and 10 dB) that is considered to be absolutely required. If this level is exceeded, the digital power from the transmitter will be reduced if the PA voltage is at maximum. If the spectral mask still cannot be met and the setting for it is enabled, the transmitter power set-point will be reduced. Default setting is 0.0 dB.

Configuring Installed Hardware

NOTE: You can also configure transmitter hardware using the AUI (see [Hardware Configuration](#), on page 3.2.109).

From the controller's UI, you can configure the transmitter for any installed hardware that has optional variations (e.g., quantity of exciters or LVPS modules, fan speed) or is non-standard (e.g., UPS or audio processor). To view the HW Config screen, select User Settings -> HW Config from the Main Menu (see [Figure 3.2.98](#)).

NOTE: These settings are established at the factory based on the configuration that existed at time of shipping. Changes to these setting are only necessary if hardware is added or removed by the user.

Figure 3.2.103: HW Config Menu



This menu has six sub-menu options:

- ❖ [Installed Exciter - see page 3.2.121.](#)
- ❖ [LVPS Hardware - see page 3.2.121](#)
- ❖ [LVPS Voltage - see page 3.2.122](#)
- ❖ [Fan Speed - see page 3.2.122](#)
- ❖ [UPS Installed - see page 3.2.123](#)
- ❖ [Audio Processor - see \[Enabling and Operating the Orban Audio Processor\]\(#\), on page 3.2.196](#)

Installed Exciter

NOTE: You can also adjust the Installed Exciter setting using the AUI (see [Hardware Configuration](#), on page 3.2.109).

From the controller UI, you can configure the transmitter for the number of installed exciters. If you have upgraded your transmitter to dual exciters, you may have already been prompted to change this configuration. To view the Installed Exc screen, select System Settings -> HW Config -> Installed Exc from the Main Menu (see [Figure 3.2.104](#)).

Figure 3.2.104: Installed Exciter Screen

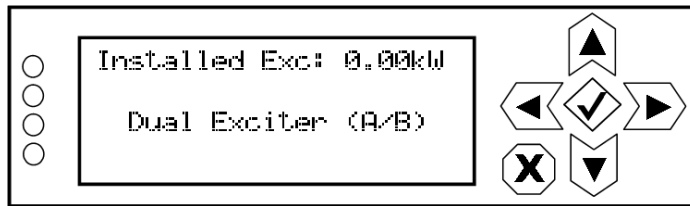

Use the up and down buttons to select the appropriate exciter configuration - Exciter (A) or Dual Exciter (A/B). Press the accept (checkmark) button to save the change. Press X to abort the change and return to the previous menu.

LVPS Hardware

NOTE: You can also adjust the LVPS Hardware setting using the AUI (see [Hardware Configuration](#), on page 3.2.109).

From the controller UI, you can configure the transmitter for the number of installed LVPS modules. If you have upgraded your transmitter to dual LVPS modules, you may have already been prompted to change this configuration. To view the LVPS Hardware screen, select System Settings -> HW Config -> LVPS Hardware from the Main Menu (see [Figure 3.2.105](#)).

Figure 3.2.105: LVPS Hardware Screen

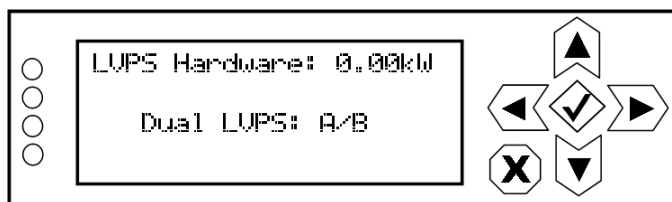

Use the up and down buttons to select the appropriate LVPS configuration - Single LVPS: A or Dual LVPS: A/B. Press the accept (checkmark) button to save the change. Press X to abort the change and return to the previous menu.

LVPS Voltage

NOTE: You can also adjust the LVPS Voltage setting using the AUI (see [Hardware Configuration, on page 3.2.109](#)).

From the controller UI, you can set the default LVPS voltage. The transmitter will set the LVPS voltage to this value (between 35 and 53 V, in 1 V steps) during normal operation. Under fault conditions, if the LVPS voltage requires an increase, the control system automatically increases the LVPS voltage, then decreases it back to the set value when the fault condition clears. This setting should not require adjustment.

To view the LVPS Voltage screen, select System Settings -> HW Config -> LVPS Voltage from the Main Menu (see [Figure 3.2.106](#)).

Figure 3.2.106: LVPS Voltage Screen

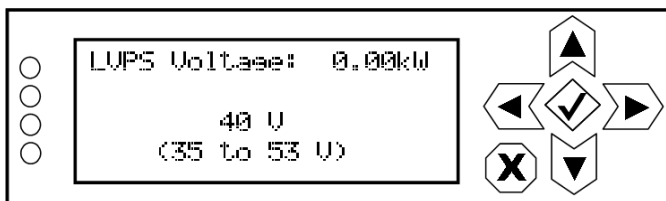

Use the up and down buttons to select a voltage between 35 and 53 V (in 1 V steps). The default setting is 40 V. Press the accept (checkmark) button to save the change. If a reset is selected, it will occur immediately. Press X to abort the change and return to the previous menu.

Fan Speed

NOTE: You can also adjust the Fan Speed setting using the AUI (see [Hardware Configuration, on page 3.2.109](#)).

The transmitter control function automatically adjusts fan speed to ensure adequate cooling based on all operating conditions. As a result this setting should not require adjustment. Increasing the fan speed will allow for cooler transmitter operation, but will also decrease efficiency and increase acoustic noise levels.

From the controller UI, you can set the default speed of the transmitter's cooling fans. The transmitter will set the fan speed to a percentage (between 63 and 100%) of the maximum speed during normal operation. Under fault conditions, the control system determines if an increase or decrease in fan speed is required and automatically adjusts the fan speed.

To view the Fan Speed screen, select System Settings -> HW Config -> Fan Speed from the Main Menu (see [Figure 3.2.107](#)).

Figure 3.2.107: Fan Speed Screen

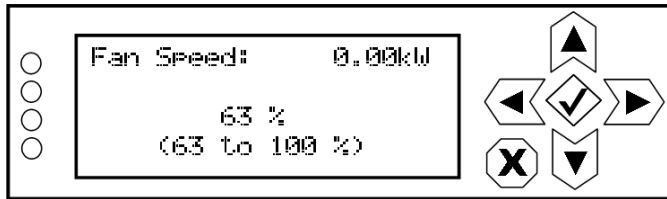

Use the up and down buttons to select a value between 63 and 100 %. The default setting is 63%, which corresponds to approximately 31 V for the related fan voltage. A setting of 100% corresponds to approximately 48 V for the related fan voltage. Press the accept (checkmark) button to save the change. Press X to abort the change and return to the previous menu.

NOTE: A 20% reduction in fan speed can yield up to 5 dB improvement in acoustic noise from the transmitter, as well as decrease power consumption (i.e., utility costs) and extend the operating life of the cooling fans.

UPS Installed

NOTE: You can also adjust the UPS Installed setting using the AUI (see [Hardware Configuration, on page 3.2.109](#)).

From the controller UI, you can configure the transmitter for the installation of the UPS interface kit, which allows operation with an external, user-provided UPS. If you have upgraded your transmitter with the UPS interface, you may have already been prompted to change this configuration. To view the UPS Installed screen, select System Settings -> HW Config -> UPS Installed from the Main Menu (see [Figure 3.2.108](#)).

Figure 3.2.108: UPS Installed Screen

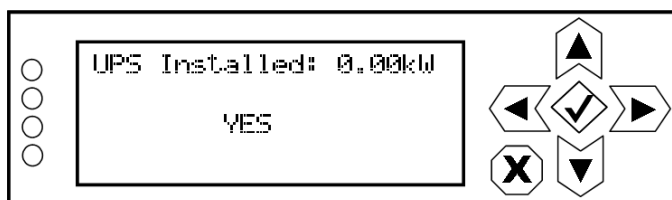

Use the up and down buttons to toggle between NO (no UPS interface installed) and YES (UPS interface is installed). Press the accept (checkmark) button to save the change. Press X to abort the change and return to the previous menu.

FM Polarity

NOTE: Adjusting FM polarity is used to synchronize transmitters for a single-frequency network. It determines whether positive audio input results in positive or negative modulation. You can also adjust the FM polarity using the AUI (see [FM Polarity, on page 3.2.111](#)).

From the front panel UI, you can set the FM polarity. To view the FM Polarity screen, select System Settings -> FM Polarity from the Main Menu (see [Figure 3.2.109](#)).

Figure 3.2.109: FM Polarity Screen

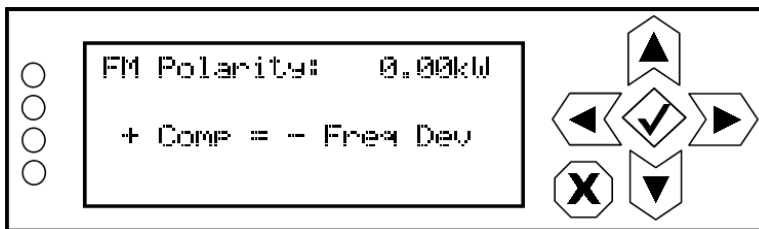

Use the up and down buttons to toggle between + Comp = - Freq Dev and + Comp = + Freq Dev. The default setting is + Comp = - Freq Dev . Press the accept (checkmark) button to save the change. Press X to abort the change and return to the previous menu.

Adjusting Factory Settings

NOTE: Factory Settings are only available using the controller UI.

CAUTION! Changing values in the System Settings -> Factory Settings menu is not normally required, and should only be performed by trained personnel. Information on some of these sub-menus is not included in the manual. Contact Nautel for assistance.

From the controller's UI, you can adjust various factory settings such as critical parameter thresholds, calibration values, exciter power level, etc. To view the Factory Settings menu (see [Figure 3.2.110](#)), select User Settings -> Factory Settings from the Main Menu.

Figure 3.2.110: Factory Settings Menu

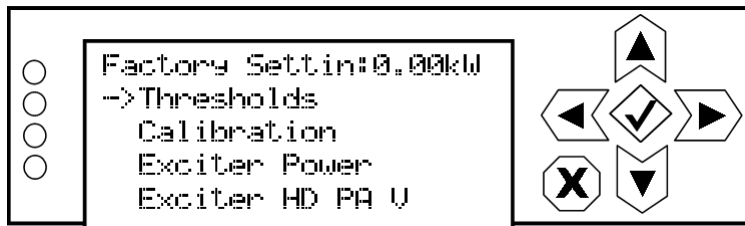

This menu has four sub-menu options:

- ❖ [Thresholds](#) - see page 3.2.126
- ❖ [Calibration](#) - see page 3.2.127 (see **IMPORTANT** note below)
- ❖ [Exciter Power](#) - see page 3.2.129
- ❖ [Exc HD PA V](#) - see page 3.2.129

:

IMPORTANT! The Calibration menu (see [Calibration](#), on page 3.2.127) contains a Xmtr PA Bias routine that must be initiated after any of the following events:

- ❖ A new RF power module has been installed in the transmitter
- ❖ RF power modules have swapped positions
- ❖ A new controller module has been installed in the transmitter

Thresholds

NOTE: Threshold settings are only available using the controller UI.

WARNING! Threshold settings are established at the factory and should not require any adjustment. These settings affect critical system protection circuits. Making changes to these settings may void your warranty. Contact Nautel before making changes.

From the controller's UI, you can set alarm thresholds for critical parameters. To view the Thresholds menu (see [Figure 3.2.111](#)), select System Settings -> Factory Settings -> Thresholds from the Main Menu.

Figure 3.2.111: Thresholds Menu

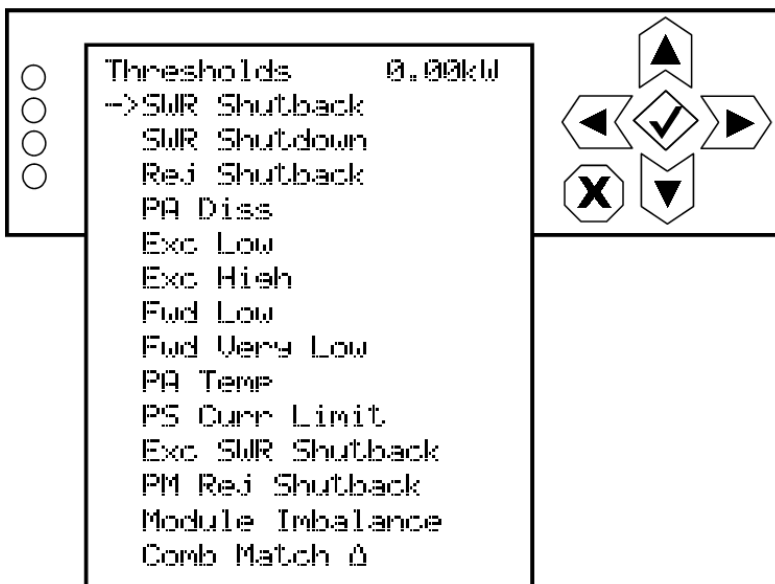

Calibration

NOTE: Most of the Calibration settings are only available using the controller UI. Calibration of audio related parameters (see [Figure 3.2.112](#)) can also be performed using the AUI (see [Audio Input Calibration](#), on page 3.2.112).

From the controller's UI, you can calibrate various parameters. To view the Calibration menu (see [Figure 3.2.112](#)), select System Settings -> Factory Settings -> Calibration from the Main Menu.

Figure 3.2.112: Calibration Menu

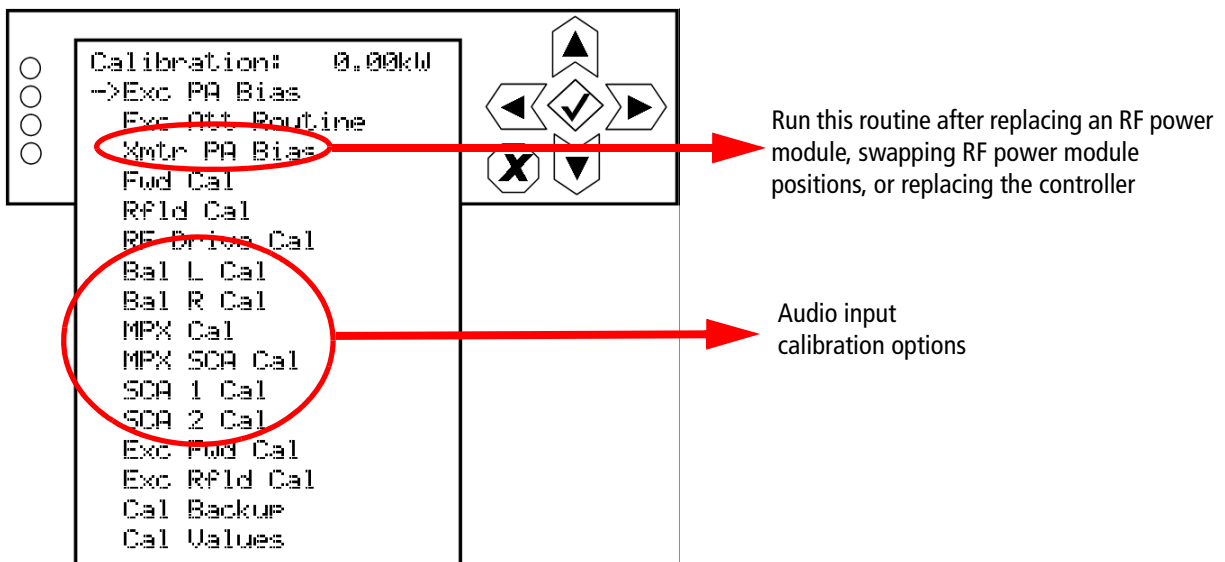

RUNNING THE XMTR PA BIAS ROUTINE. You must run the transmitter's PA bias routine immediately after one of the following events:

- ❖ installation of a new RF power module
- ❖ swapping of existing RF power modules
- ❖ installation of a new controller module

NOTE: Make sure that the RF stage is disabled (RF Off) and the interlock circuit is closed before running the PA bias routine. If not, a message will appear on the display prompting you to do so.

Use the up or down arrow to place the cursor next to Xmtr PA Bias, then press the accept (checkmark) button to enter the sub-menu. Within the sub-menu, press the accept (checkmark) button to start the routine. A line will display to indicate the percentage of completion. When it is complete, the display will again read "Press ✓ to begin". Press X to return to the previous menu.

CALIBRATING AUDIO INPUTS. Use the up or down arrow to place the cursor next to the desired audio input calibration item (Bal L Cal, Bal R Cal, MPX Cal, MPX SCA Cal, SCA 1 Cal or SCA 2 Cal), then press the accept (checkmark) button to enter the selected audio input. With the appropriate calibrated audio source(s) applied, use the up and down arrows to set the new calibration value for the selected audio input. When complete, press the accept (checkmark) button to save the change. Press cancel (X) to discard changes and return to the previous menu.

NOTE: Forward power (Fwd Cal), reflected power (Refl Cal), RF Drive, exciter forward (Exc Fwd) and exciter reflected (Exc Rfld) calibrations are performed at the factory and should not require user adjustment. Contact Nautel for assistance, if necessary.

Exciter Power

NOTE: The exciter power setting is only available using the controller UI.

From the controller UI, you can set the exciter's power level at 98 MHz. To view the Exciter Power screen, select System Settings -> Factory Settings -> Exciter Power from the Main Menu (see [Figure 3.2.113](#)). The transmitter automatically compensates the actual exciter power level based on the operating frequency so there should be no need to adjust this value.

Figure 3.2.113: Exciter Power Screen

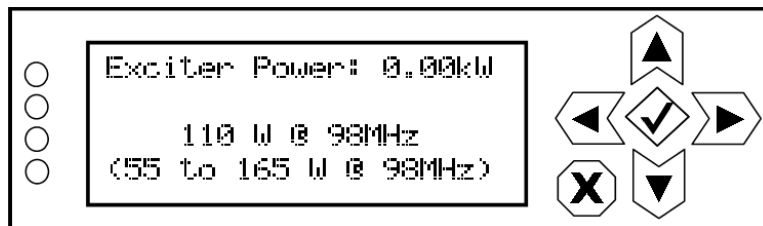

Use the up and down buttons to select a power level between 55 and 165 W (in 5 W increments). Press the accept (checkmark) button to save the change. Press X to abort the change and return to the previous menu.

Exc HD PA V

NOTE: The exciter power setting is only available using the controller UI.

From the controller UI, you can set the exciter's HD PA voltage. To view the Exc HD PA V screen, select System Settings -> Factory Settings -> Exc HD PA V from the Main Menu (see [Figure 3.2.114](#)).

Figure 3.2.114: Exc HD PA V Screen

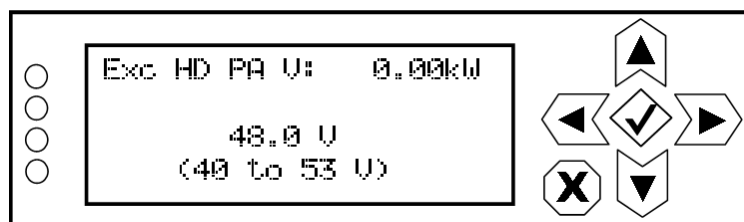

Use the up and down buttons to select a voltage between 40 and 53 V (in 0.5 V increments). Default setting is 48.0 V. Press the accept (checkmark) button to save the change. Press X to abort the change and return to the previous menu.

User Accounts

NOTE: This function is only available via the AUI.

Depending on user permission rights, you can set up accounts to allow certain users to access and control features of the AUI using the [User Accounts page](#) - see [Figure 3.2.115](#). To view the User Accounts page, select User Accounts from the Menu options.

NOTE: Depending on the permission level assigned to a given user, some features shown in [Figure 3.2.115](#) may not be displayed or available.

This section includes the following topics:

- [Setting User Permission Level](#), on page 3.2.131
- [Editing Account Information](#), on page 3.2.131
- [First-Time Login](#), on page 3.2.133

Figure 3.2.115: User Accounts page

The screenshot shows the 'User Accounts : Nautel' web interface. It features two main tabs: 'Users' and 'Settings'. The 'Users' tab displays a list of user accounts: 'Admin', 'CustomUser' (which is highlighted), 'Nautel (Auto)', and 'SNMP_User'. Below this list are 'Add' and 'Delete' buttons. The 'Settings' tab is currently active, showing configuration options for the selected 'CustomUser'. This section includes a 'User Type' dropdown menu with options: 'Custom', 'View Only', 'Administrator', 'Full Control', and 'Custom'. There is also an 'Auto Login' checkbox. A 'Change Password' section contains three input fields: 'Old Password', 'New Password', and 'Confirm Password'. To the right, a 'Permissions' section lists several options with checkboxes: 'Activate/Modify Presets', 'Power Control', 'Delete Logs', 'RF On/Off', and 'All other settings'. At the bottom of the settings panel, there are 'Apply', 'Cancel', and 'Apply Changes' buttons.

The GV5/GV3.5 contains a default user account when it leaves the factory. This account appears as Nautel (Auto) in the List of Users and has Super User permission level. The default Username is "Nautel". The default Password is blank (i.e., no password). Nautel recommends that you delete this account once you create the desired user account(s) (see [First-Time Login](#), on page 3.2.133).

Setting User Permission Level

There are four levels of permission that can be assigned to users, each with their own specific function. All users have permission to change their own username and password, but are otherwise limited to the following functions:

- View Only: Can monitor equipment data only. No administrative or control functions.
- Full Control: Can monitor and control equipment, with no administrative functions.
- Administrator: Can perform all functions. Administrator is the only permission level that allows addition, removal or modification of users.
- Custom: Administrator can customize the user permissions by manually selecting the permission levels.

Editing Account Information

Adding an Account

You must be an Administrator to use this function.

Procedure to add a user (see [Figure 3.2.116 on page 3.2.133](#)):

1. Open the User Accounts page.
2. Press Add (bottom of the screen) to open a small Add User window.
3. Beside Username, enter a name that identifies the new user, and press OK.
4. Select the new user to edit the settings.
5. Beside User Type, press the arrow to reveal a drop-down menu and select a type of user. If you select Custom as the type of user, then go to the Permissions section of the screen and mark individual permissions (see [Changing Permissions, on page 3.2.132](#)).
6. Press Apply to confirm your entries and create a new user or press Cancel to ignore your entries and exit the small window without creating a new user.

Editing an Existing Account

To edit an existing user account, press on the desired user in the Users list on the left-side of the AUI. The Settings for that user will be displayed on the right-hand side of the AUI. You can edit the Password, User Type (see [Setting User Permission Level](#) above), Auto Login status and Permissions.

Changing the Password

To change your password, press the Change Password button. A menu appears that prompts you to enter the old password, new password and confirmation of the new password. Press Apply to save or Cancel to exit this menu (see [Figure 3.2.116 on page 3.2.133](#)).

Setting Auto Login (Local Only) Status

When checked () the selected user account will be automatically logged in to the transmitter with all the rights and privileges that have been assigned to that user. There may only be one autologin user at any given time; when the Auto Login check box is selected for one user account, it is automatically cleared on all other users. When not checked, the transmitter will not login automatically and will instead prompt for username and password when it boots up. It should be noted that only accounts with Administrator level permissions can set or remove Auto Login status.

Changing Permissions

You must be an Administrator to edit this function.

All users have permission to change their own username and password. You can customize the permissions assigned to a user or simply pick a predetermined set of permissions based on the user type.

Procedure to change user permissions (see [Figure 3.2.116 on page 3.2.133](#)):

1. Open the User Accounts page.
2. Select a user from the Users list to display the permissions for that user in the center of the Permissions window. The permissions associated with the selected user are identified with a checkmark ()
3. Press on User Type to reveal a drop-down menu and select a new type of user.
4. If the user type in step 3 is Custom, set individual permissions. Under Permissions, place a checkmark () beside each permission that you want to associate with the user. The boxes work like a toggle - select the checkbox to place a checkmark and select again to remove the checkmark. Choose one or more of the following options:
 - ❖ Activate/Modify Preset - Allows the user to modify presets and change the active preset.
 - ❖ Power Control - Allows the user to change the power set point of the transmitter.
 - ❖ Delete Logs - Allows the user to remove log entries.

- ❖ RF On/Off - Allows the user to turn the RF output on and off.
- ❖ All Other Settings - Allows the user to adjust all settings not mentioned above, except for administrating user accounts.

5. Press Apply to assign the new permissions to the selected user.

Removing an Account

To remove a user account, select the desired user from the Users list and press the Delete button. A verification prompt will appear. Press Yes to proceed or No to cancel the deletion.

NOTE: Do not delete the SNMP_User account from the list of users.

Figure 3.2.116: User Accounts Page Layout

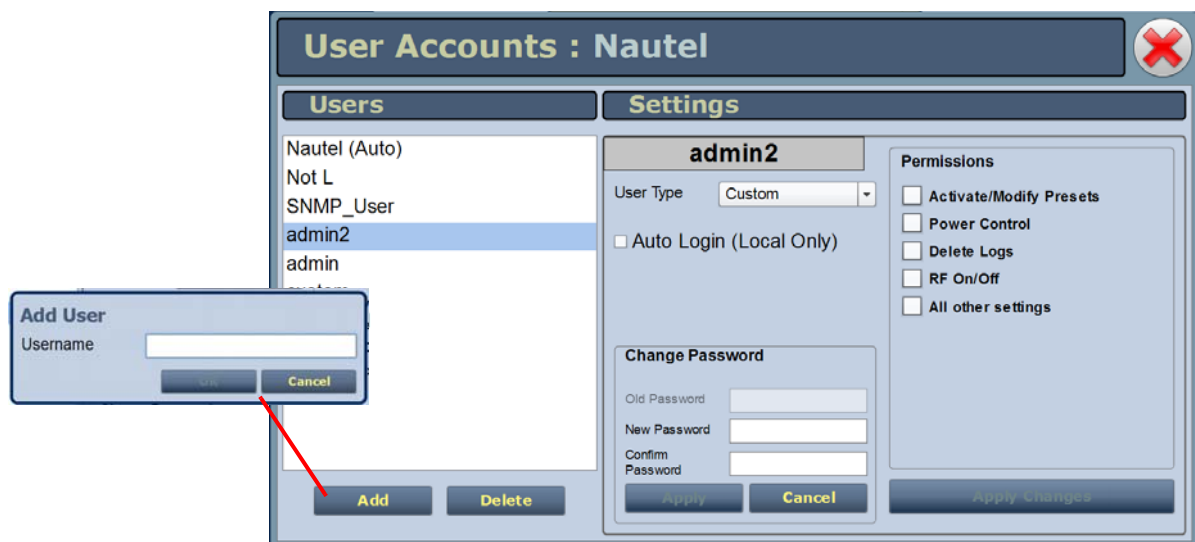

First-Time Login

When you enter the User Accounts page for the first time, it is recommended you create an account and then delete the default Nautel account, as follows:

1. Login to the AUI using the default Username ("Nautel") and Password (blank).
2. Set up your own Administrator account, with your desired Username and Password.
3. Logout of the AUI, then login to your new Administrator account.
4. Delete the "Nautel" account.

Changing Exciter Transfer Settings

If your transmitter contains dual exciters and is configured to operate with dual exciters, you can control the auto exciter transfer function using the AUI (see [Exciter Changeover Settings - using the AUI](#)) or using the controller UI (see [Exciter Changeover Settings - using the Controller UI](#), on page 3.2.135).

Exciter Changeover Settings - using the AUI

To view the Changeover page (see [Figure 3.2.117](#)), select Changeover from the Menu options or press on the Active Exciter area in the top, right-hand corner of the AUI. The Changeover page is only displayed on the Main Menu window and the Active Exciter shortcut is only available when dual exciters are installed and configured.

NOTE: In order to edit any changeover settings, the transmitter must be configured for *Dual Exciter (A/B)* in the controller UI's Installed Exc screen (see [Installed Exciter](#), on page 3.2.121).

Figure 3.2.117: Changeovers page



Active Exciter	<input type="text" value="A"/>
Main Exciter	<input checked="" type="radio"/> A <input type="radio"/> B
Auto Changeover Enabled	<input checked="" type="radio"/> Yes <input type="radio"/> No
Delay	<input type="text" value="2.00 s"/> <input type="button" value="Apply"/>

- ❖ The Active Exciter is displayed (also displayed in the top, right corner of the AUI).
- ❖ For Main Exciter , select A or B. Defaults to A if Standby Exciter is set to No.
- ❖ For Auto Changeover Enabled, select Yes if automatic changeover is desired or No if user selected/manual changeover is desired.

NOTE: If the standby exciter must be removed for service, Nautel recommends you set Auto Changeover Enabled to No while the standby exciter is unavailable for operation, instead of temporarily setting Standby Exciter to No.

- ❖ For Standby Exciter (appears when dual exciters are installed), select Yes if standby operation is available or desired or No if standby operation is not available or not desired. This is factory set and does not typically require adjustment.
- ❖ In the Delay field, enter the desired exciter transfer delay (in seconds; between 2 s and 120 s; default is 2 s) and press Apply.

Exciter Changeover Settings - using the Controller UI

From the controller UI, you can set the active exciter, main exciter, auto changeover status, changeover delay and exciter configuration. To view the Changeover screen, select System Settings -> Changeover from the Main Menu (see [Figure 3.2.118](#)).

NOTE: In order to edit any changeover settings, the transmitter must be configured for *Dual Exciter (A/B)* in the front panel UI's Installed Exc screen (see [Installed Exciter, on page 3.2.121](#)).

Figure 3.2.118: Changeover Menu

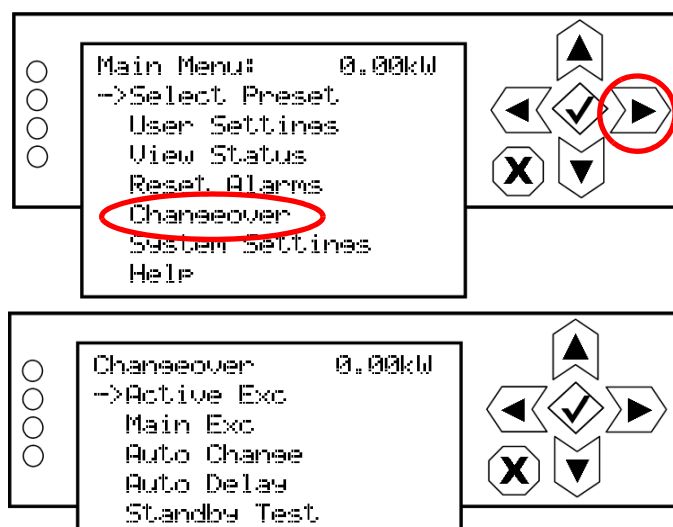

This menu has five sub-menu options. Use the up and down buttons to move the cursor to the desired display setting and then press the right button to enable editing of the setting. [Figure 3.2.119 on page 3.2.136](#) shows the editing screens for the Changeover menu. Within any of the editing screens, use the up and down buttons to edit a setting. Press the accept (checkmark) button to save the change. Press cancel (X) to discard changes and return to the previous menu.

WARNING! Before using the Standby Test function, make sure that the standby exciter's RF output is being applied to a suitably rated test load.

Figure 3.2.119: Changeover Editing Screens

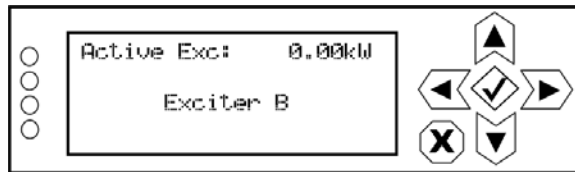

For display only. Indicates the active exciter - Exciter A or Exciter B. Press the cancel (X) button to return to the previous menu.

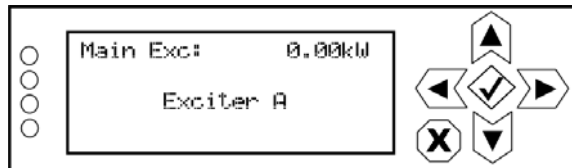

Allows user to set the transmitter's main exciter to Exciter A or Exciter B. Typically, the main exciter is the exciter that operates until an automatic changeover occurs. The default setting is Exciter A. Press the cancel (X) button to discard changes and return to the previous menu.

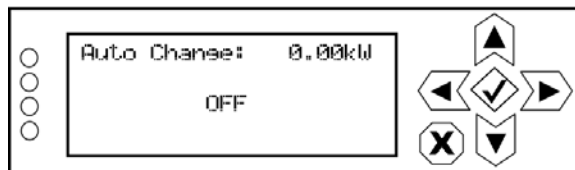

Configures the transmitter to enable (ON) or disable (OFF) automatic exciter changeover. Changeover to the standby exciter occurs if the current/active exciter experiences a fault that inhibits its operation. Press the cancel (X) button to discard changes and return to the previous menu.

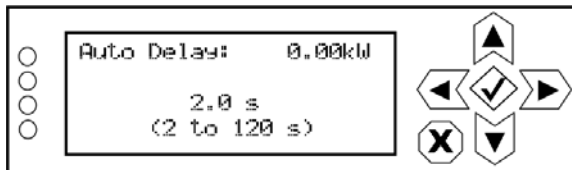

Sets the delay period after which an automatic changeover will occur to a value between 2 and 120 seconds (in 0.1 s increments). Default value is 2 s. Press the cancel (X) button to discard changes and return to the previous menu.

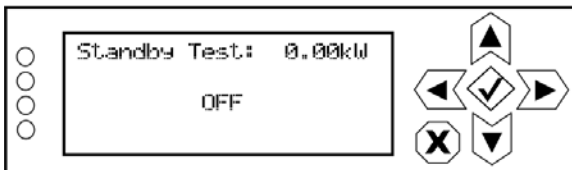

Configures the transmitter to enable (ON) or disable (OFF) the standby exciter's RF power stage to allow testing into a user provided dummy load. When enabled (ON), the exciter will operate at 100 W (ensure the test load is suitably rated). While enabled, auto exciter changeover is disabled (regardless of configuration status). Press the cancel (X) button to discard changes and return to the previous menu.

User Settings - AUI

The User Settings page (see [Figure 3.2.120](#) on [page 3.2.138](#)) allows operators to modify various custom user settings such as network and email notifications. To view the User Settings page, select User Settings from the Menu options. Press X in the upper, right corner to close this page and return to the Home page.

The User Settings options include:

- [Network Setup](#), on [page 3.2.138](#) ***
- [Email Configuration](#), on [page 3.2.143](#)
- [Notifications](#), on [page 3.2.145](#)
- [Configuring Engine Settings](#), on [page 3.2.147](#)
- [Nautel Phone Home](#), on [page 3.2.149](#)
- [SNMP Configuration](#), on [page 3.2.150](#)
- [Capturing Critical Parameters](#), on [page 3.2.152](#)
- [Using an External 10 MHz Input](#), on [page 3.2.153](#) ***
- [Spectrum Mask](#), on [page 3.2.155](#)
- [Setting the Clock](#), on [page 3.2.156](#) ***
- [Configuring NTP Servers](#), on [page 3.2.159](#)
- [Setting User Thresholds](#), on [page 3.2.161](#) ***
- [Setting Call Sign/ID](#), on [page 3.2.164](#)
- [Turn-On Behaviour](#), on [page 3.2.165](#) ***

*** **NOTE:** The controller UI also has a User Settings menu, which contains similar functions to the AUI (e.g., network setup, setting the clock, etc.), and additional settings that are described in [User Settings - Controller UI](#), on [page 3.2.166](#). Unless otherwise noted, the following functions are only available via the AUI.

Figure 3.2.120: User Settings menu - Network Setup page shown

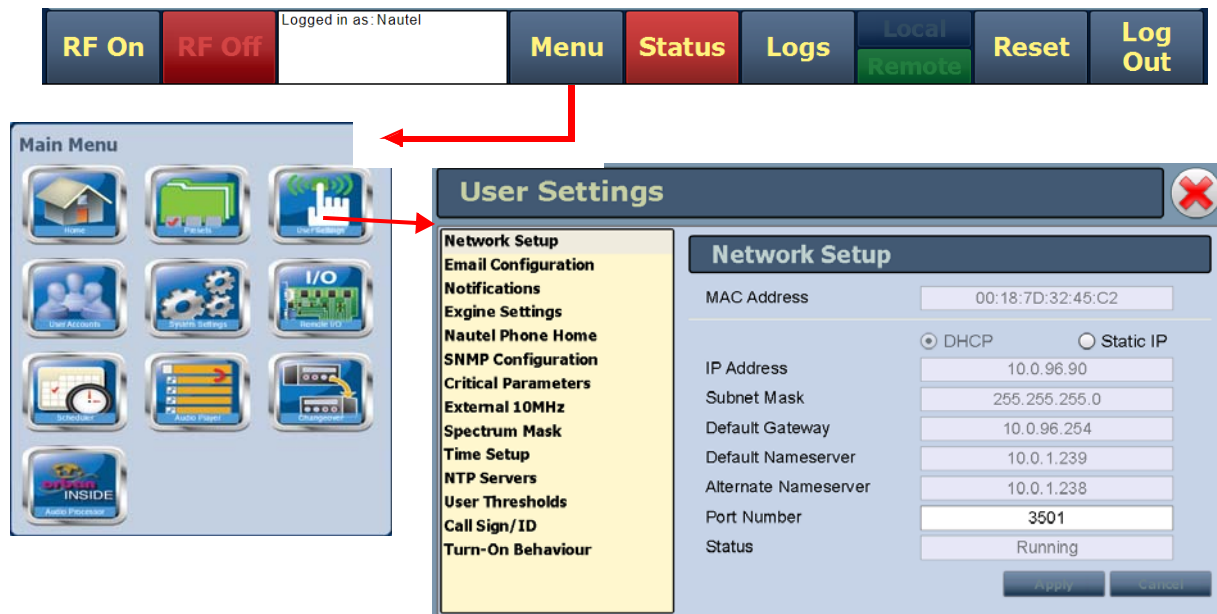

Network Setup

You can configure network settings using the AUI (see [Network Setup - Using the AUI](#), on page 3.2.139) or the controller UI (see [Network Setup - Using the Controller UI](#)). If you change a network setting on the AUI, it will also be reflected on the controller UI, and vice versa.

NOTE: Nautel recommends that the following network settings be entered/vetted by a qualified Network Administrator. If parameters are changed and the AUI is reset, record the new values (or see the local front panel UI) to ensure you can log in after changes have been made.

Determining DHCP Setting

One of the main decisions in configuring the network connection on your GV5/GV3.5 transmitter is whether you set DHCP to ON or OFF. If you are connecting to a network, consult with a network administrator before connecting the transmitter to your network to determine whether to enable (turn ON) or disable (turn OFF) the DHCP setting.

When DHCP is set to ON (default from factory), IP addresses are assigned automatically by the network server. In order for this feature to function properly, you must have a network-viewable DHCP server on your network.

If a DHCP server is not present, you (or your network administrator) must provide static addresses for IP, netmask, gateway and nameservers (gateway and nameservers are optional). You must enter them manually using the AUI or controller UI. In this case, DHCP should be set to OFF.

Network Setup - Using the AUI

1. Open the User Settings page by pressing Menu/User Settings on the Home page (see [Figure 3.2.120](#) on [page 3.2.138](#)).
2. Select the Network Setup option (left-side of the screen) to display related information and associated parameters on the right-side of the screen. (see [Figure 3.2.121](#) on [page 3.2.140](#)).
3. Enter the following parameters (where applicable):
 - ❖ Mac Address - Displays a number that serves as unique network adapter identifier. This is set by the manufacturer and is displayed for informational purposes only (cannot be user set). It may be necessary to use this number to allow the AUI to access your network.
 - ❖ DHCP or Static IP - Defines whether the IP Address, Subnet Mask, Default Gateway, Default Nameserver and Alternate Nameserver will be provided manually (Static IP) or automatically by the access point (i.e., a router) through DHCP. In either case, the access point must be configured with the correct settings, which match the settings on the AUI in order for the AUI to access the network. Your parameter selection affects other parameter entries. If Static IP was selected, enter the IP Address, Subnet Mask and Default Gateway.
 - ❖ IP Address - displays unique numerical network identifier for the transmitter.
 - ❖ Subnet Mask - Masks an IP address, and divides the IP address into network address and host address.
 - ❖ Default Gateway - Defines the address of the network access point.
 - ❖ Default Nameserver - Address that identifies the DNS host. The DNS (Domain Name System) translates internet domain and host names to IP addresses. DNS automatically converts the name in the web browser address bar to the IP addresses of web servers hosting those sites.
 - ❖ Alternate Nameserver - Redirects the name server.
 - ❖ Port Number - Used to identify the senders and receivers of messages. Also supports port forwarding (remapping) which allows the AUI of multiple NV Series transmitters to be accessed on the same network. See your network router documentation for additional remapping information and instructions.

NOTE: Changes to this port are reset to 3501 after a software upgrade. Reconfigure as required.

- ❖ Status - Identifies the status of the network.
 - Running: transmitter is connected to a network and is functioning properly.
 - Not Running: transmitter is not connected or is not functioning properly. When in this state, remote AUI access is not possible.
4. Press Apply to accept entries/changes made to the network parameters.

Figure 3.2.121: Network Setup page

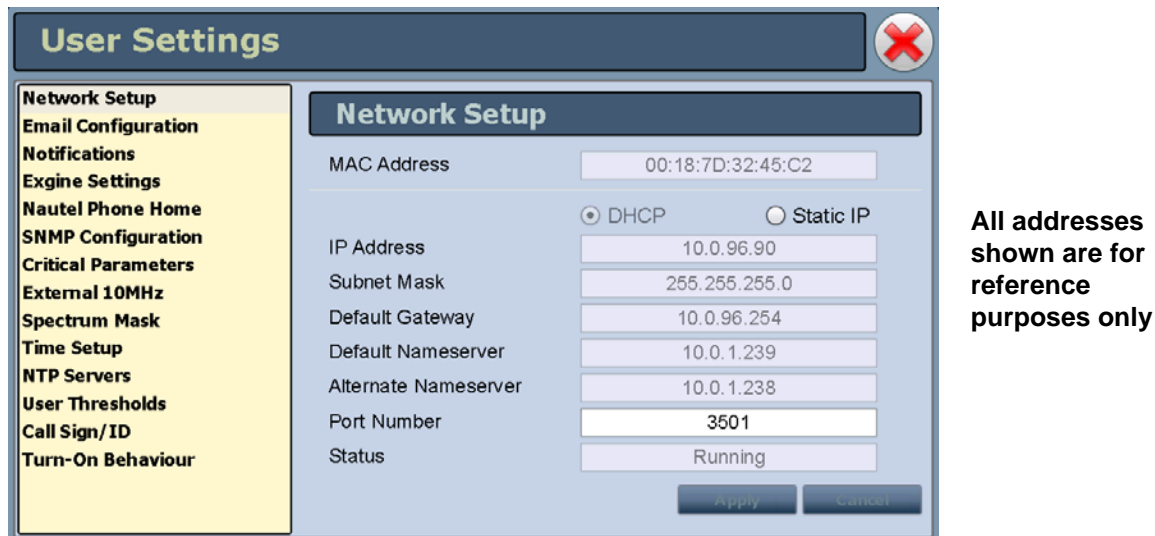

Network Setup - Using the Controller UI

From the controller's UI, in local mode, you can set or change network settings. To view the Network Settings screen, select User Settings -> Network Settings from the Main Menu. See [Figure 3.2.122 on page 3.2.141](#) for details on setting each parameter.

Use the up and down buttons to move the cursor to the desired parameter and then press the right button to enable editing of the setting. Within any of the editing screens, use the left and right buttons to select a character for editing and then use the up and down buttons to edit a setting. Press the accept (checkmark) button to save the change. Press the cancel (X) button to discard changes and return to the previous menu.

NOTE: A nameserver (also called a DNS) translates a host name (e.g., mail.nautel.com) to an IP address such as in configuring email (see [Email Configuration, on page 3.2.143](#)).

If you are using a laptop to connect to the GV5/GV3.5, see [Connecting a Laptop Directly to the Transmitter, on page 3.2.142](#).

Figure 3.2.122: Network Settings screens

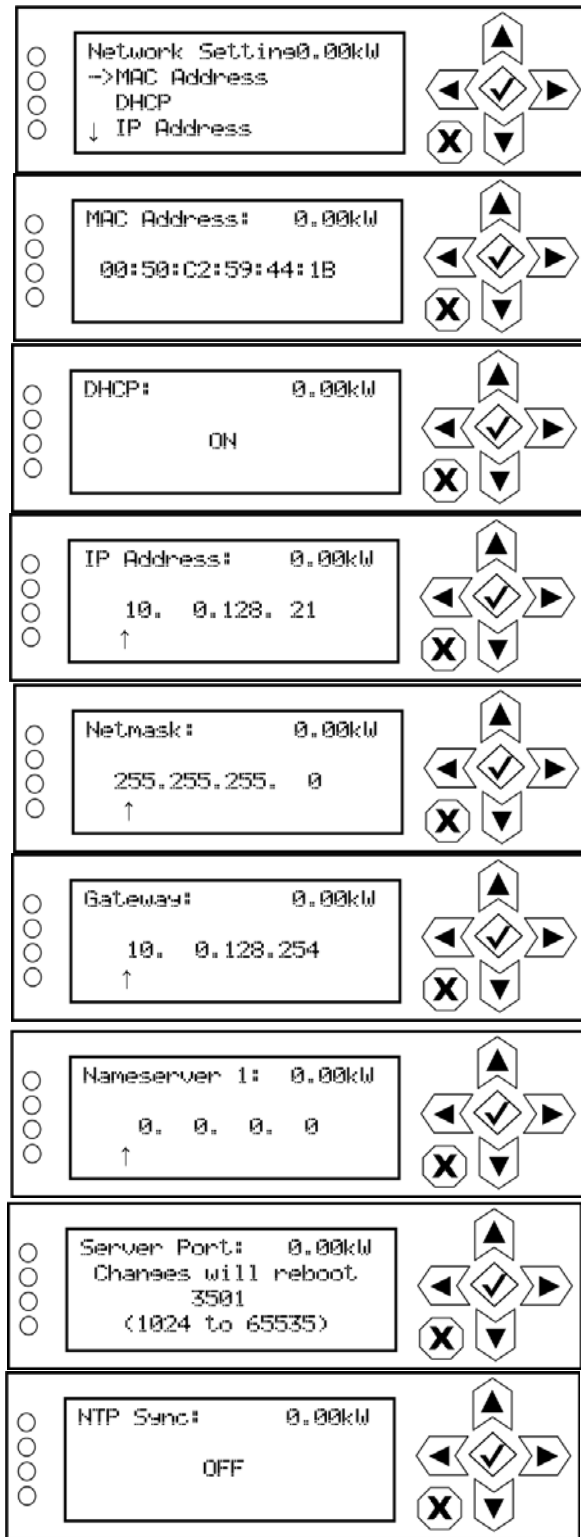

All addresses shown are for reference purposes only

Displays a number that serves as unique network adapter identifier. This is set by the manufacturer and is displayed for informational purposes only (cannot be user set). It may be necessary to use this number to allow the AUI to access your network.

Set to ON to automatically assign the IP Address, Netmask, Gateway, Nameserver 1 and Nameserver 2 by the access point (i.e., a router) or set to OFF to manually assign. In either case, the access point must be configured with the correct settings, which match the settings on the AUI in order for the AUI to access the network.

Displays a unique numerical network identifier for the transmitter. If DHCP was set to OFF, specify the IP address. Consult with your network administrator.

Masks an IP address, and divides the IP address into network address and host address. If DHCP was set to OFF, specify netmask. Typical netmask address shown. Consult with your network administrator.

Defines the address of the network access point. If DHCP was set to OFF, specify the gateway address. Consult with your network administrator.

Address that identifies the DNS host. The DNS (Domain Name System) translates internet domain and host names to IP addresses. DNS automatically converts the name typed into a web browser address bar to the IP addresses of web servers hosting those sites. If DHCP is set to OFF, specify the address.

Used to identify the senders and receivers of messages. Also supports port forwarding (remapping) which allows the AUI of multiple transmitters to be accessed on the same network. See your network router documentation for additional remapping information and instructions. NOTE: Changes to this port are reset to 3501 after a software upgrade; reconfigured the port, as required, after an upgrade.

NTP = Network Time Protocol.
Set to ON to allow the network to synchronize to the transmitter time.
Set to OFF to use the transmitter's internal time reference.

Connecting a Laptop Directly to the Transmitter

If connecting to the GV5/GV3.5 directly with a laptop, you must set a static IP address on the GV5/GV3.5 and your laptop.

1. From the controller UI's Main Menu, go to User Settings -> Network Settings and set the IP address as follows:
 - ❖ DHCP: OFF
 - ❖ IP Address: 10.10.10.2
 - ❖ Netmask: 255.255.255.0

2. Set the transmitter for Remote control.

NOTE: The following steps assume the operating system is Windows XP. Adapt as required for computers with different operating systems.

3. On the laptop, go to Start Menu/Control Panel/Network Connections/Local Area Network.
4. In the Local Area Network Status, open the General tab and choose Properties. Scroll down and highlight Internet Protocol (TCP/IP). Choose Properties.
5. In the Internet Protocol (TCP/IP) Properties window, select Use the following IP address.
6. Enter the following settings:
 - ❖ IP Address: 10.10.10.1
 - ❖ Subnet Mask: 255.255.255.0
 - ❖ Default Gateway: 192.168.1.2
7. In the Internet Protocol (TCP/IP) Properties window, select OK.
8. In the Local Area Connection Properties window, select OK.
9. In the Local Area Connection Status window, select Close.
10. Close the Network Connections window.
11. Enter the IP address (10.10.10.2) into a web browser's address bar to connect to the transmitter's remote AUI.

Email Configuration

The Email Configuration page (see [Figure 3.2.123](#)) allows you to configure email parameters (e.g., email server and port number), and is required if the notification feature is used (see [Notifications, on page 3.2.145](#)).

NOTE: Nautel recommends that the following settings be entered/vetted by a qualified Network Administrator.

Figure 3.2.123: Email Configuration page

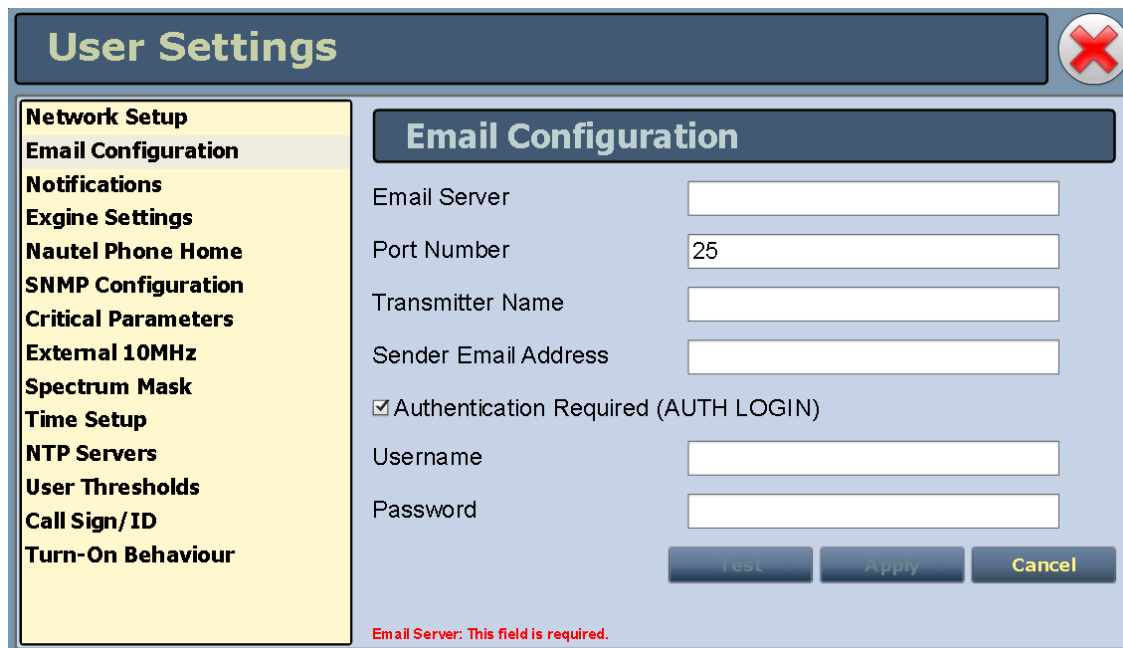

The screenshot shows a web interface titled "User Settings" with a close button (red X) in the top right corner. On the left is a vertical navigation menu with the following items: Network Setup, Email Configuration (highlighted), Notifications, Engine Settings, Nautel Phone Home, SNMP Configuration, Critical Parameters, External 10MHz, Spectrum Mask, Time Setup, NTP Servers, User Thresholds, Call Sign/ID, and Turn-On Behaviour. The main content area is titled "Email Configuration" and contains the following fields and controls:

- Email Server:
- Port Number:
- Transmitter Name:
- Sender Email Address:
- Authentication Required (AUTH LOGIN)
- Username:
- Password:

At the bottom of the form are three buttons: "Test", "Apply", and "Cancel". A red error message is displayed at the bottom left: "Email Server: This field is required."

To configure the email feature, perform the following steps:

1. Open the User Settings page by pressing Menu/User Settings in the Home page.
2. Select the Email Configuration option (left-side of the screen) (see [Figure 3.2.123](#)) to display related information and associated parameters on the right-side of the screen.

3. Enter the following parameters:

- ❖ **Email Server:** The outgoing mail server. Enter the server name or IP address here. In order to enter a server name (e.g., mail.nautel.com), at least one nameserver IP address must be entered (see [Network Setup, on page 3.2.138](#)).
- ❖ **Port Number:** This logical connection end point uses a number to identify the type of process to which an internet or other network message is to be forwarded to when it arrives at a server. Typically, this is set to 25 for unencrypted SMTP systems and 843 for encrypted email..
- ❖ **Transmitter Name:** Set to a name that associates to the transmitter such as station identification (e.g., GV10_WXYZ). This name will be included in notification emails.
- ❖ **Sender Email Address:** Enter as a standard email address (e.g., a@b.com). This will be the sender address that notification email recipients will see. Free web-based email service accounts (Gmail, Hotmail, Yahoo mail etc.) are acceptable here.
- ❖ **Authentication Required:** If your email server requires authentication to send emails, select the check box and enter the appropriate Username and Password to allow this. If the check box is not selected, the Username and Password fields do not appear.
- ❖ **Username:** Enter the username for your outgoing email server.
- ❖ **Password:** Enter the password for your outgoing email server.

NOTE: The transmitter will automatically handle encryption if the associated mail server requires it.

4. When complete, select Apply or Cancel to restore the previous setting. Use the Test button to enter an address to which an email will be sent to to verify your settings. Enter the recipient address and press the OK button to send the test email or press the Cancel button to return to the Email Configuration page.

Notifications

The Notifications page (see [Figure 3.2.124](#)) provides a means for the transmitter to issue emails triggered by user defined alarm events. If you use this feature, you must also configure an email (see [Email Configuration](#), on page 3.2.143).

Figure 3.2.124: Notifications page

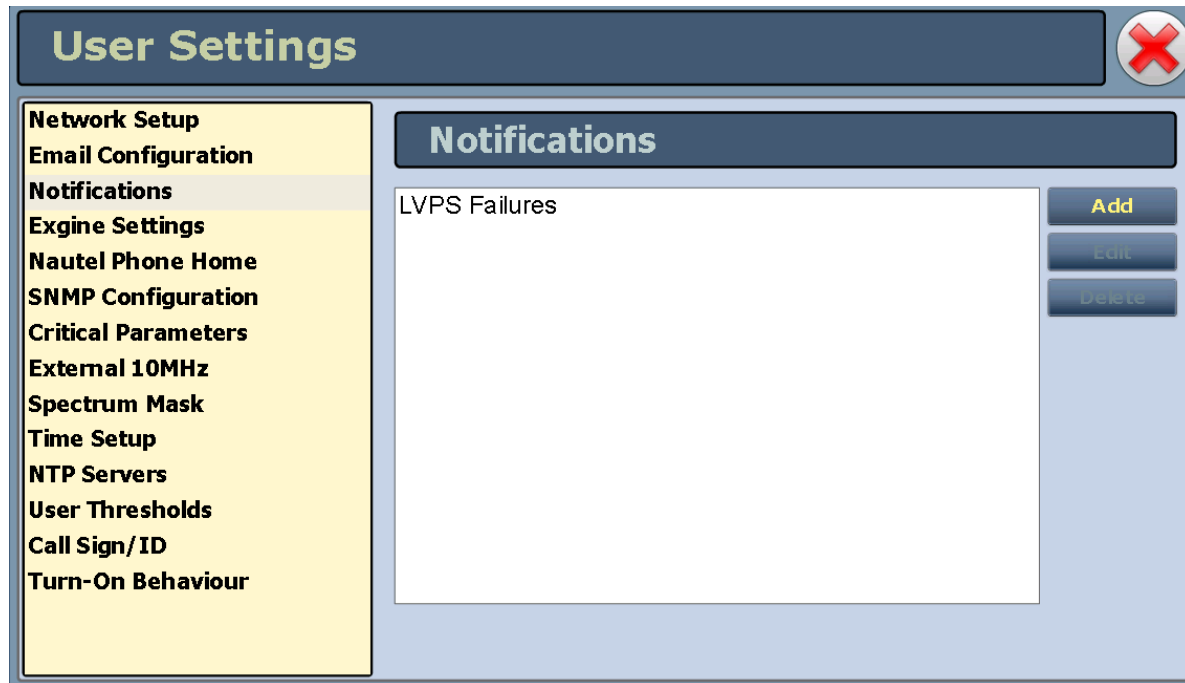

To configure the notifications feature, perform the following steps:

1. Pre-existing notifications are displayed in the Notifications list (e.g., "LVPS Failures". Press Add to create a new item for notification, press Update (after highlighting an existing item) to edit an existing item or press Delete to erase an item.
2. When you press Add or Edit, the screen in [Figure 3.2.125 on page 3.2.146](#) will appear. This screen allows you to add or edit a Notification Name, Recipient Email, and define the alarm list by Device type (Controller, Exciter A or B, Rack #or RF Module #). Add or remove alarms by moving them (using the >> and << arrow buttons) from the Available Alarms list to the Selected Alarms list. An email is issued when any alarm in the Selected Alarms list is active.
3. When complete press the OK button to accept changes or the Cancel button to discard changes and return to the Notifications page.

Figure 3.2.125: Notifications adding/updating page

Notification

Notification Name

Recipient Email(s)

Device

Available Alarms		Selected Alarms
10kWReject Fan 1 Fail	➤	+1.2V Fail - Controller
10kWReject Fan 2 Fail		+1.8V Fail - Controller
10kWReject Fan 3 Fail	➤	+12VA (AU) Fail - Controller
5kWReject Fan 1 Fail		+12VB (SBC) Fail - Controller
5kWReject Fan 2 Fail	➤	+15V Fail - Controller
5kWReject Fan 3 Fail		+3.3V Fail - Controller
5kWReject Fan 4 Fail	➤	+5VA Fail - Controller
5kWReject Fan 5 Fail		+5VB Fail - Controller
5kWReject Fan 6 Fail	➤	-15V Fail - Controller
AC Summary		
ARM Network Down	▼	

OK **Cancel**

Configuring Engine Settings

The Engine Settings page (see [Figure 3.2.126](#)) allows you to set signal parameters and determine IP information for use with the Engine option.

Figure 3.2.126: User Settings - Engine Settings

Engine Settings	
Digital Carriers	<input checked="" type="radio"/> On <input type="radio"/> Off
Protocol	<input checked="" type="radio"/> UDP <input type="radio"/> TCP
Engine IP	10.0.96.197
Exporter IP	0.0.0.0
Netmask	255.255.255.0
Gateway	10.0.96.254
E2X Port	9000
MAC Address	40:D8:55:01:90:4E

Procedure to configure Engine Settings:

1. Open the User Settings page by pressing Menu/User Settings in the Home page.
2. Select the Engine Settings option (left-side of the screen) to display a list of pre-existing notifications on the right-side of the screen. Press Refresh to ensure that the latest Engine configuration information is loaded.
3. Enter the following parameters (if applicable) and press Apply.
 - ❖ Digital Carriers - Select On or Off.
 - ❖ Protocol - Selects the E2X protocol to use UDP (default) or TCP. Match this setting to the Exporter configuration.
 - ❖ Engine IP, Netmask and Gateway - Configure the Engine's IP network parameters as assigned by the local network administrator. If no gateway is used or assigned, enter 0.0.0.0.
 - ❖ Exporter IP - Enter the Exporter's IP address of the interface where the data stream is originating. It is used to filter E2X traffic in case multiple exporters are used in broadcast mode on a single LAN. 0.0.0.0 is also a valid configuration.

- ❖ E2X Port - The engine expects E2X on port 9000. Some non-Nautel Exporters utilize port 11000 instead.
 - ❖ Mac Address - Displays a number that serves as unique network adapter identifier. This is set by the manufacturer and is displayed for informational purposes only. It may be necessary to use this number to allow the AUI to access your network.
4. When finished, press Apply to accept your entries or press Cancel to ignore your changes and exit this window.

Nautel Phone Home

Phone Home is a system developed by Nautel that takes advantage of the vast amount of data collected by Nautel transmitters by proactively sending information to the cloud via the internet once a user enables Phone Home on their transmitter.

This data includes logs, alarms and meter readings which are then stored in a database and can be analyzed by Nautel staff if an alarm is reported by the transmitter. Since all data is pushed out to Nautel by the transmitter to the cloud, there is no need to reconfigure your firewall and potentially compromise your transmitters security. All data transfers are one way.

Nautel Transmitters are intelligent, collecting data on nearly every aspect affecting your transmitters performance. When this data is used by Nautel customer support staff for diagnostics purposes it cuts down on repair time and gets you back on air faster.

Nautel customer service technicians can use Phone Home to analyze data in real time, even accessing the live AUI, or to view the state of a customer's transmitter at any time leading up to a fault.

This unique diagnostic approach allows Nautel support staff to take a trip back in time and review the events leading up to and during an alarm occurrence, giving customer service technicians valuable insight into how your transmitter is behaving before, during and after an alarm and how this behavior may be related to the alarm event.

Figure 3.2.127: Nautel Phone Home

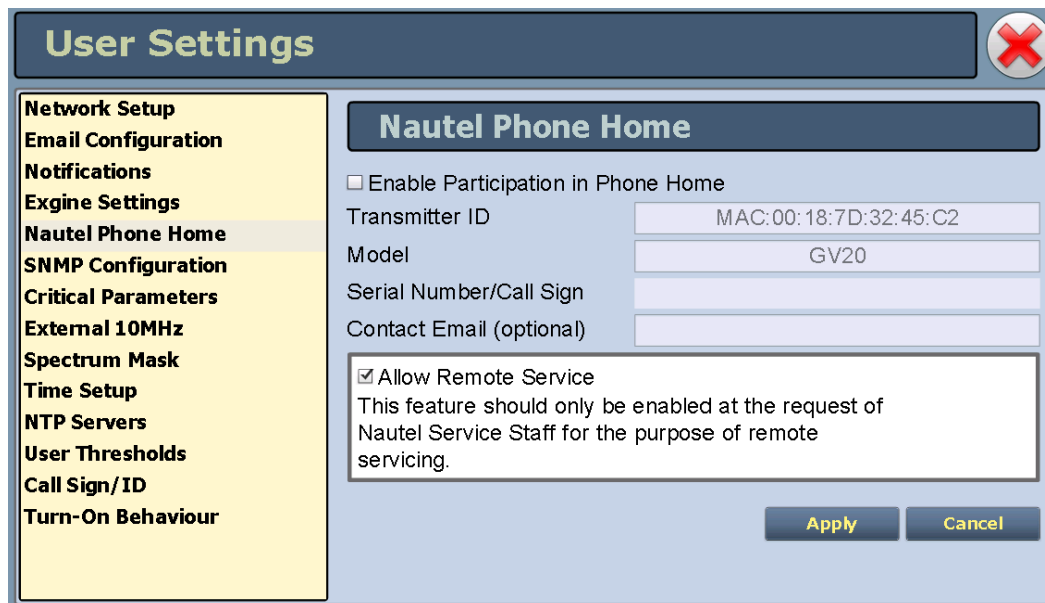

The screenshot shows a 'User Settings' window with a sidebar on the left containing a list of settings categories: Network Setup, Email Configuration, Notifications, Engine Settings, Nautel Phone Home (highlighted), SNMP Configuration, Critical Parameters, External 10MHz, Spectrum Mask, Time Setup, NTP Servers, User Thresholds, Call Sign/ID, and Turn-On Behaviour. The main area is titled 'Nautel Phone Home' and contains the following configuration options:

- Enable Participation in Phone Home
- Transmitter ID: MAC:00:18:7D:32:45:C2
- Model: GV20
- Serial Number/Call Sign: [Empty field]
- Contact Email (optional): [Empty field]
- Allow Remote Service

A text box below the 'Allow Remote Service' checkbox contains the warning: 'This feature should only be enabled at the request of Nautel Service Staff for the purpose of remote servicing.' At the bottom right of the window are 'Apply' and 'Cancel' buttons.

SNMP Configuration

The SNMP Configuration page (see [Figure 3.2.128](#)) provides a means to configure the SNMP agent and associated traps.

Figure 3.2.128: SNMP Configuration page - Agent tab shown

The screenshot shows a web interface titled "User Settings" with a red "X" close button in the top right. On the left is a vertical menu with the following items: Network Setup, Email Configuration, Notifications, Exgine Settings, Nautel Phone Home, SNMP Configuration (highlighted), Critical Parameters, External 10MHz, Spectrum Mask, Time Setup, NTP Servers, User Thresholds, Call Sign/ID, and Turn-On Behaviour. The main content area is titled "SNMP Configuration" and has two tabs: "Agent" (selected) and "Traps". Under the "Agent" tab, there are five input fields: "Agent Port" with the value "161", "Read Community" with "*****", "Confirm" with "*****", "Write Community" with "*****", and "Confirm" with "*****". Below these fields is a checkbox labeled "Enable Traps" which is currently unchecked. At the bottom right of the form are "Apply" and "Cancel" buttons.

Agent Settings

Using the Agent tab (see [Figure 3.2.128](#)), configure the SNMP agent as follows:

1. Enter the five fields, noting the following:
 - ❖ Agent Port: Enter the UDP port where the SNMP agent checks for requests. The default setting is 161. If your transmitter is behind a firewall, you must open this port to use SNMP.
 - ❖ Read Community: Enter the password for the SNMP client application to allow acquisition of channel values. Provide confirmation of this password in the Confirm field.
 - ❖ Write Community: Enter the password for the SNMP client application to allow changing of channel values. Provide confirmation of this password in the Confirm field.
2. Select the Enable Traps check box to allow the SNMP agent to send trap notifications (see [Traps Settings on page 3.2.151](#)). Enter the two additional fields as follows:

- ❖ Trap Receiver IP: Enter the IP address of the computer to which the SNMP agent will send trap notifications. The computer must be running an SNMP application that is configured to receive traps. The SNMP agent will send trap notifications to at most one receiver.
 - ❖ Trap Receiver Port: Enter the UDP port where the SNMP agent will send traps. The default setting is 162.
3. When complete press Apply or click Undo to restore the previous settings.

Figure 3.2.129: SNMP Configuration page - Traps tab shown

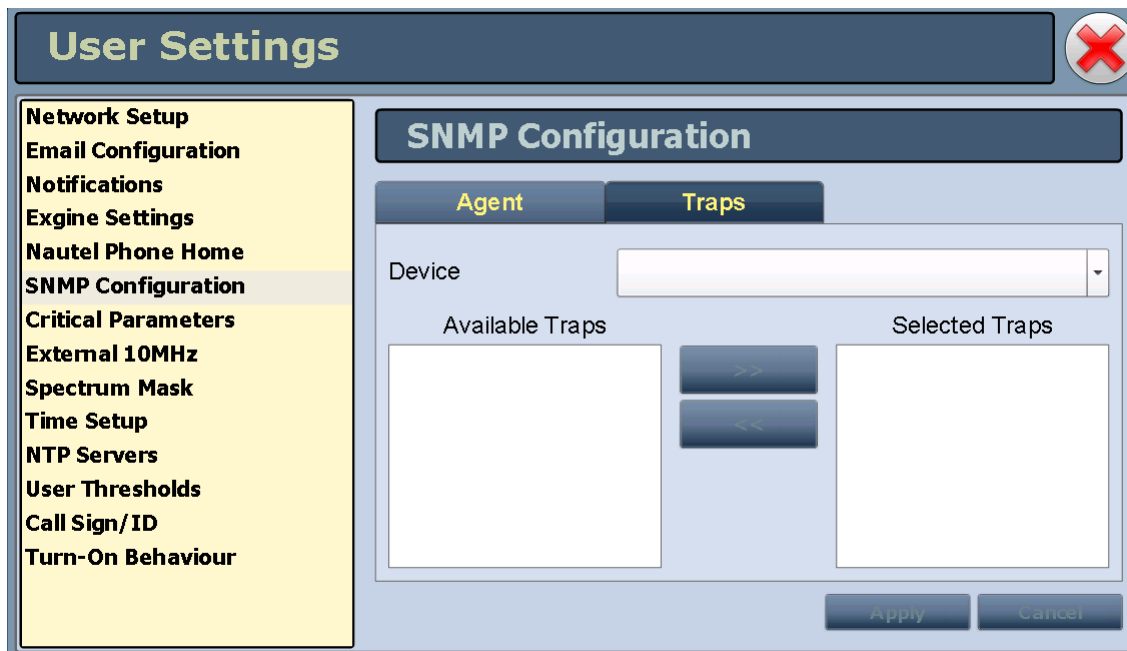

Traps Settings

A trap is an unsolicited message sent by an SNMP agent to an SNMP client when an alarm changes state (turns on or off). The message is an SNMP packet that can be interpreted and displayed by an SNMP client application. Using the Traps tab (see [Figure 3.2.129](#)), select your desired traps as follows:

1. Find the desired alarm(s) by selecting the appropriate Device type (Controller or Exciter) and scrolling through the Available Traps list. Add or remove traps to and from the Selected Traps list using the >> and << arrow buttons).
2. When complete press Apply to save or press Cancel to restore the previous setting.

Capturing Critical Parameters

NOTE: This feature is available only through the remote AUI.

You can capture critical parameter data for the transmitter's current state using the AUI's Critical Parameters page (see [Figure 3.2.130](#)). To view this page, select Critical Parameters from the User Settings page. From this page, you can select Capture Meters (reads all meter values), Capture Alarms (reads all active alarms), Capture Presets (reads current preset) and Capture Settings (reads current settings, e.g., active exciter, threshold settings, scale factors, etc.). Once you select the Capture button, you can select the associated Copy button to copy the data to your remote PC's clipboard. The data copies in a tab-delimited format and is ideally suited for pasting into a spreadsheet program. Select X in the upper, right corner to close this page and return to the Home page.

Figure 3.2.130: Critical Parameters page

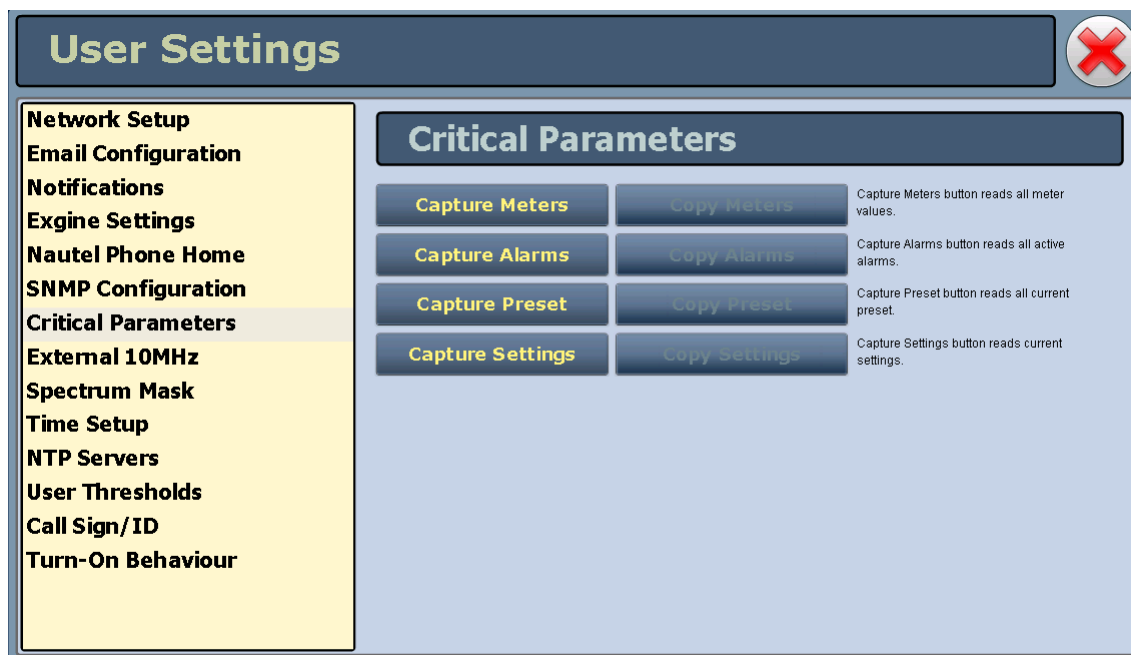

Using an External 10 MHz Input

You can configure the GV5/GV3.5 to accept an external 10 MHz input using the AUI (see [External 10 MHz Input - using the AUI](#)) or using the Icontroller UI (see [External 10 MHz Input - using the Controller UI, on page 3.2.154](#)).

This setting allows the user to mask the associated 10 MHz alarm from appearing on the Status page if it isn't being used. If an external 10 MHz source is being used, select Yes; this ensures that an alarm will be activated on the Status page should the external signal be lost. If an external 10 MHz source is not being used, leave the default No setting as is. This will ensure that no alarm will be displayed on the Status page despite the presence of the external 10 MHz signal.

NOTE: The exciter will automatically use an external 10 MHz reference signal if connected, no matter the state of this parameter.

External 10 MHz Input - using the AUI

You can view the selection buttons for the external 10 MHz input on the the AUI's External 10 MHz page (see [Figure 3.2.131](#)) by selecting External 10 MHz from the User Settings options. Yes and No buttons for Use External 10MHz are displayed. Press Yes if you are using an external 10 MHz signal. Press No if not. Press X in the upper, right corner to close this page and return to the Home page.

Figure 3.2.131: External 10 MHz screen

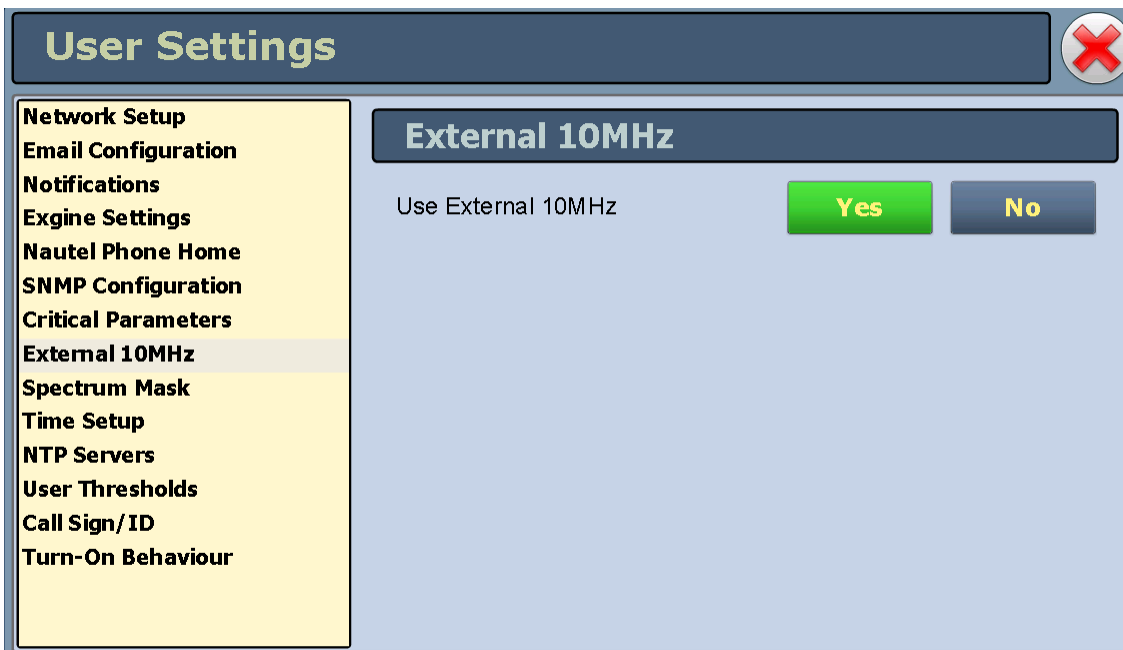

External 10 MHz Input - using the Controller UI

To view the enable/disable screen for the external 10 MHz input (see [Figure 3.2.132](#)), select User Settings -> Ext. 10 MHz Inp from the Main Menu.

Figure 3.2.132: Front Panel - External 10 MHz Input screen

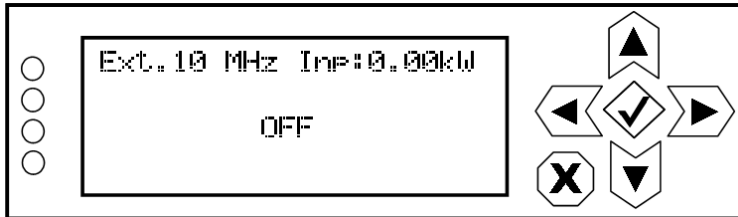

Use the up or down arrow to toggle between ON (using external 10 MHz input) and OFF (not using external 10 MHz input), then press the accept (checkmark) button to save the change. Press cancel (X) to discard changes and return to the previous menu.

Spectrum Mask

The Spectrum Mask page (see [Figure 3.2.133](#)) allows users to select the appropriate FM mask standard (FCC, ETSI or None) being used by the analyzer. The selection affects the mask lines on the Spectrum Analyzer instrument. Use the Mask Type pull down menu to select the desired mask (the factory setting is FCC). Press the Apply button to save the change or press Cancel to discard changes.

Figure 3.2.133: User Settings - Spectrum Mask

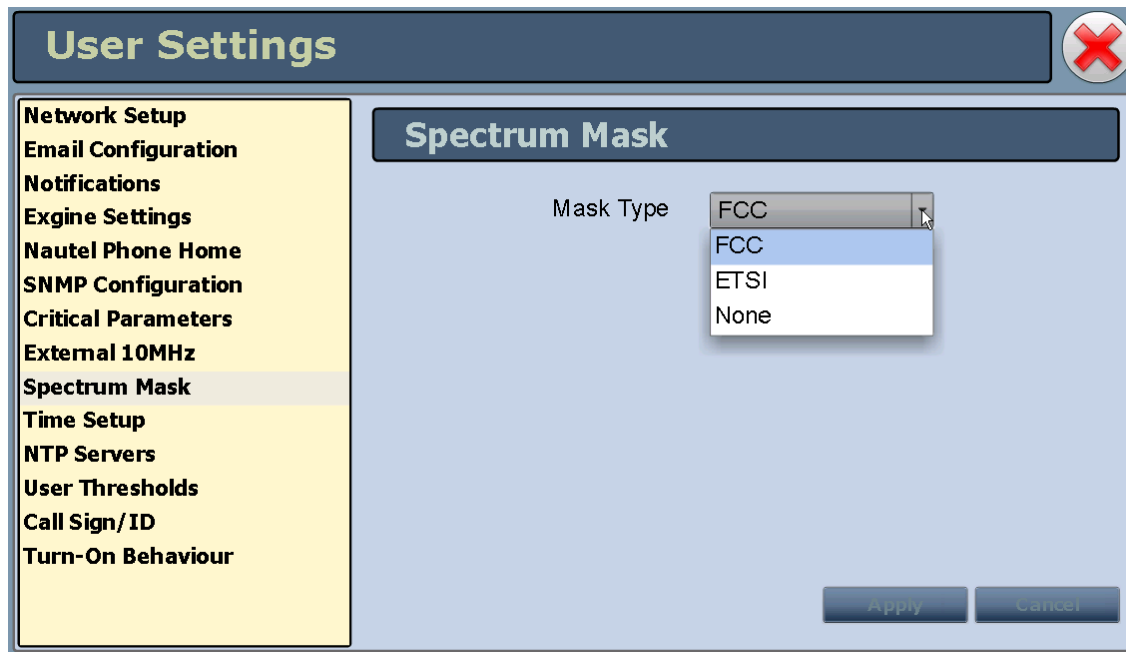

Setting the Clock

The GV5/GV3.5 controller module's internal clock uses an externally accessible backup battery, and therefore maintains an accurate date and time, even during power outages. The date and time needs to be set when the transmitter is first installed, or after a power outage if the backup battery has failed.

You can set the date and time using the AUI (see [Setting the Clock - using the AUI](#)) or using the controller UI (see [Setting the Clock - Using the Controller UI, on page 3.2.158](#)). If you change the clock setting on the controller UI, it will also be reflected on the remote AUI, and vice versa. If the NTP feature is enabled (see [Enabling NTP, on page 3.2.159](#)), the clock will set automatically and cannot be manually adjusted.

Setting the Clock - using the AUI

You can set the GV5/GV3.5's time and date using the AUI's Time Setup page (see [Figure 3.2.134](#)) by selecting Time Setup from the User Settings options. The date and time setting is displayed in the upper, left corner of the AUI.

Figure 3.2.134: Time Setup Page

User Settings

- Network Setup
- Email Configuration
- Notifications
- Engine Settings
- Nautel Phone Home
- SNMP Configuration
- Critical Parameters
- External 10MHz
- Spectrum Mask
- Time Setup**
- NTP Servers
- User Thresholds
- Call Sign/ID
- Turn-On Behaviour

Time Setup

Time: Hour: 21, Min: 52, Sec: 19

Date: Day: 18, Month: Mar, Year: 2014

Cannot change time; NTP is enabled

Apply Cancel

Timezone: America/Halifax UTC -3:00

Region: Select a region...

Country: [Dropdown]

Zone: [Dropdown]

Apply Cancel

The Time Setup option allows users to set the exact time and date information as well as regional and timezone settings for a transmitter location. Set the time and date as follows:

1. Select the Time Setup option from the left-side of the User Settings page to open a related window on the right-side of the page.
2. Enter Time and Date parameters and press Apply. Press Cancel to discard changes. Please note that Time and Date cannot be set via this menu if NTP is enabled (see [Enabling NTP, on page 3.2.159](#)).
 - ❖ Time - enter the hour (24-hour clock), minutes (up to 60), and seconds (up to 60).
 - ❖ Date - select values from the drop-down menus beside Day, Month, and Year.
3. Enter the following location parameters and press Apply. Press Cancel to discard changes:
 - ❖ Timezone - automatically set based on Region, Country and Zone selections.
 - ❖ Region - select the appropriate region from the drop-down menu.
 - ❖ Country - select the appropriate country from the drop-down menu.
 - ❖ Zone - select the appropriate zone from the drop-down menu.

The Time Setup page contains editable fields for the time (hours, minutes and seconds), date (day, month and year) and time zone (region, country and zone). The clock is displayed in 24-hour format. Use the drop-down menus to select the desired value for a specific field. Press the appropriate Apply button to accept changes or Cancel to discard them.

Setting the Clock - Using the Controller UI

When you select User Settings -> Set Clock from the Main Menu (see [Figure 3.2.135](#)) you can set the current time and date. The time appears on the top line of the top level screen (see [Figure 3.2.8 on page 3.2.17](#)).

Figure 3.2.135: Set Clock screen

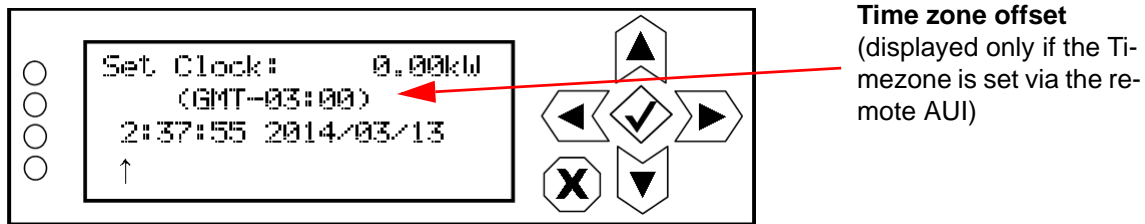

To change the time or date, use the right and left arrow buttons to move the cursor to the desired field (hours, minutes, seconds, year, month, day), and use the up and down arrow buttons to increase or decrease the value of the selected field as desired. When complete, press the accept (checkmark) button to save the change. Press the cancel (X) button to discard changes and return to the previous menu.

The time zone offset line (e.g., GMT-03:00) appears only if the Timezone has been established in the remote AUI's Time Setup page.

Configuring NTP Servers

NOTE: The following function is only available via the AUI; however, the use of NTP can also be enabled/disabled from the controller UI (see [Enabling NTP, on page 3.2.159](#)).

You can configure one or more NTP (Network Time Protocol) servers to allow clock synchronization with all computers on the same network as the GV5/GV3.5. To view the AUI's NTP Servers page (see [Figure 3.2.136](#)), select NTP Servers from the User Settings options. There are several functions available on this page - enabling NTP, monitoring NTP server status and managing servers.

NOTE: The accuracy of the NTP synchronization is related to the distance to the server. For this reason, Nautel recommends that you choose servers in the same country as the equipment. If this is not possible, attempt to connect to servers from the same continent.

Figure 3.2.136: NTP Servers Page

User Settings

- Network Setup
- Email Configuration
- Notifications
- Exgine Settings
- Nautel Phone Home
- SNMP Configuration
- Critical Parameters
- External 10MHz
- Spectrum Mask
- Time Setup
- NTP Servers**
- User Thresholds
- Call Sign/ID
- Turn-On Behaviour

NTP Servers

Enable NTP Apply

NTP Server Status

*	Remote	IP	Delay(ms)	Offset(ms)	Jitter(ms)
*	rwhois.dargalso	72.105.198.74	80.926	16.677	2.414
+	euro-shared.olin	142.3.100.2	36.800	10.828	2.806
+	ntp1.sscgateway	142.3.100.15	36.760	18.148	0.539
-	ns1.ptpbroadban	132.246.11.229	25.915	19.891	0.729

Manage Servers

0.debian.pool.ntp.org
1.debian.pool.ntp.org
2.debian.pool.ntp.org
3.debian.pool.ntp.org

Add Delete

Add NTP Server

Ok Cancel

Enabling NTP

Enable the NTP function by selecting the Enable NTP checkbox. Disable by de-selecting the Enable NTP checkbox. Press the Apply button to activate any change.

Monitoring NTP Servers

The NTP Server Status section displays tabular information on the NTP servers connected to the network. The table includes remote name, IP address, delay, offset and jitter.

- ❖ Remote Name: Displays the host name of the referenced time source. An asterisk (*) in the first column marks the reference time source that is currently preferred by the NTP daemon. A '+' character in the first column marks high quality candidates for the reference time that could be used if the currently selected reference becomes unavailable.
- ❖ IP: Displays the IP address associated with the Remote Name. In some cases the Remote Name could be the IP address.
- ❖ Delay: Displays the round-trip delay (in ms) of the time queries.
- ❖ Offset: Displays the difference (in ms) between the reference time and the system clock.
- ❖ Jitter: Displays the magnitude of jitter (in ms) between several time queries.

Managing NTP Servers

The Manage Servers section displays the NTP server files that have been added. You can Add to the list of NTP servers (see [Figure 3.2.137](#)) or Delete a selected NTP server from the list.

Figure 3.2.137: Add NTP Server

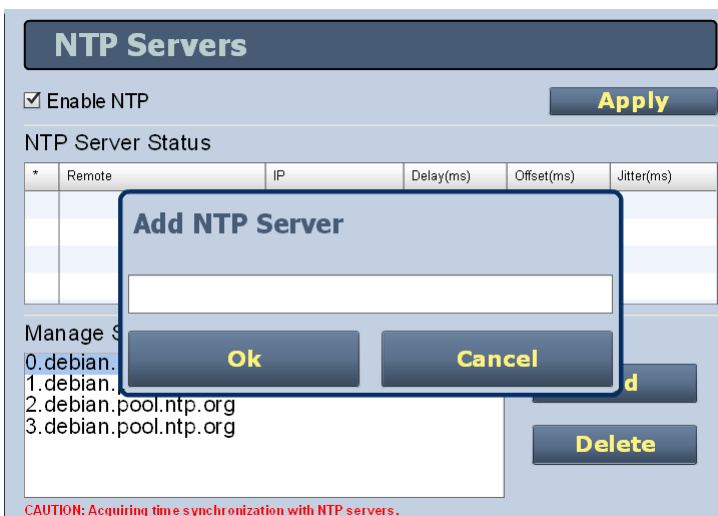

Setting User Thresholds

You can set thresholds for the main audio and SCA sources (trip level and timeout) and forward power level using the AUI (low and very lower power thresholds) (see [Setting User Thresholds - using the AUI](#)) or using the controller UI (see [Setting User Thresholds - using the Controller UI, on page 3.2.163](#)). These thresholds determine the limit for an associated low audio or low forward power alarm to be activated.

If you change a user threshold on the controller UI, it will also be reflected on the AUI, and vice versa.

Setting User Thresholds - using the AUI

The AUI's User Thresholds page (see [Figure 3.2.138](#)) has two tab sections - Low Audio and Low Forward Power.

Figure 3.2.138: User Settings - User Thresholds Page and tab sections

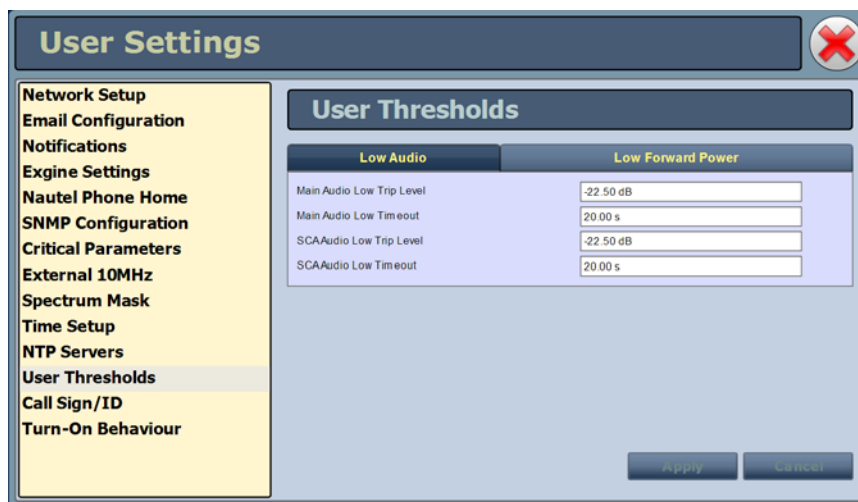

Default values shown

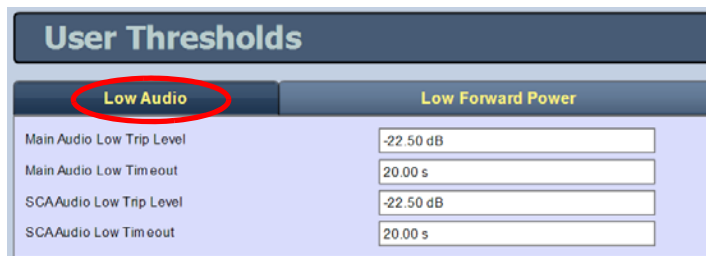

Valid range -100 to -3 dB
Valid range 0 to 600 s
Valid range -100 to -3 dB
Valid range 0 to 600 s



Valid range 0 to 100%
Valid range 0 to 100%

- Selecting the Low Audio tab displays a screen that allows for setting of the low trip level and timeout delay for the main audio and SCA audio low thresholds.
 - ❖ If the applicable audio source (main or SCA) level falls below the Trip Level setting (default is -22.5 dB) for longer than the Timeout setting (default is 20 s), an alarm will activate in the Status and Logs pages. When the audio source level increases above the Trip Level, the alarm will clear. To disable the low audio alarm, set the associated Trip Level to -100 dB. Press Apply to save the change or Cancel to discard changes.
- Selecting the Low Forward Power tab displays a screen that allows for setting of the threshold for the low forward power and very low forward power alarms.
 - ❖ If the forward power falls below the low threshold setting (default is 50% of the setpoint) or below the very low threshold setting (default is 12.5% of the setpoint), the associated alarm will activate in the Status and Logs pages. When the forward power level increases above a threshold, the alarm will clear. To disable the low forward power alarms, set the associated percentage to 0%. Press Apply to save the change or Cancel to discard changes.

Setting User Thresholds - using the Controller UI

From the controller UI, you can establish the low audio thresholds and timeout delays for the main audio and SCAs. To view the Audio Low screen, select User Settings -> Audio Low from the Main Menu (see [Figure 3.2.139](#)).

Figure 3.2.139: Audio Low Menu

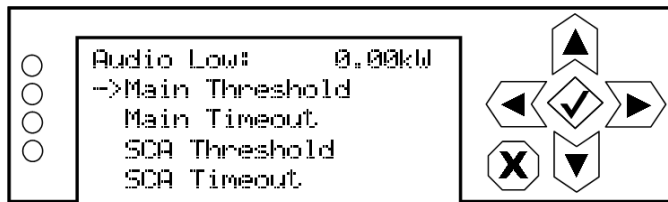

Use the up and down buttons to move the cursor to the desired line item and then press the right button to enable editing. [Figure 3.2.140 on page 3.2.163](#) shows all possible editing screens for the Audio Low menu. Within any of the editing screens, use the up and down buttons to edit the setting. Press the accept (checkmark) button to save the change. Press cancel (X) to discard changes and return to the previous menu.

Figure 3.2.140: Audio Low Editing Screens

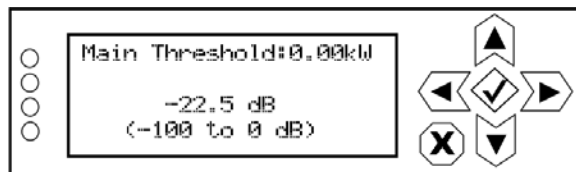

Select a level between -100 and 0 dB (in 0.5 dB increments). Press the cancel (X) button to discard changes and return to the previous menu. Default setting is -22.5 dB.

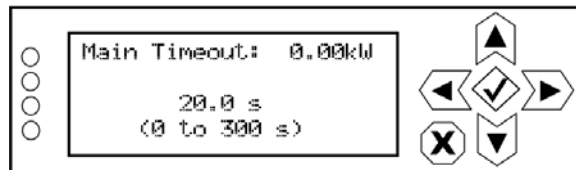

Select a timeout between 0 and 300 s (5 minutes) (in 0.5 s increments). Press the cancel (X) button to discard changes and return to the previous menu. Default setting is 20 s.

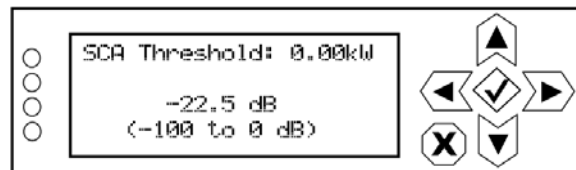

Select a level between -100 and 0 dB (in 0.5 dB increments). Press the cancel (X) button to discard changes and return to the previous menu. Default setting is -22.5 dB.

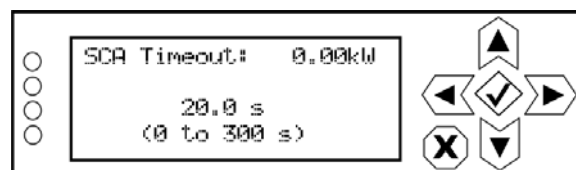

Select a timeout between 0 and 300 s (5 minutes) (in 0.5 s increments). Press the cancel (X) button to discard changes and return to the previous menu. Default setting is 20 s.

Setting Call Sign/ID

The Call Sign/ID page (see [Figure 3.2.141](#)) allows the user to set a name that identifies the transmitter on the AUI. This identification will be displayed in brackets on the top transmitter banner of the AUI and also be included as a header in any Critical Parameter data copied and pasted to a spreadsheet program (see [Capturing Critical Parameters](#), on page 3.2.152).

Enter the call sign or ID in the field (e.g., GV_ABCD) and press Apply (maximum 15 characters in length). Press Apply to save the change or Cancel to discard changes.

Figure 3.2.141: Setting Call Sign/ID

The screenshot displays the Nautel transmitter control interface. At the top, there is a status bar with the following information: Date & Time (Tue Mar 18 2014, 21:56:14), Scheduler: Off, Transmitter (GV_ABCD) (0 kW, 98.10 MHz, 1.00 kW, Preset: *Preset 1), and Exciter (Active Exciter A, FM Modulation 0.010 %). Below this is the 'User Settings' menu, which includes options like Network Setup, Email Configuration, Notifications, Engine Settings, Nautel Phone Home, SNMP Configuration, Critical Parameters, External 10MHz, Spectrum Mask, Time Setup, NTP Servers, User Thresholds, Call Sign/ID, and Turn-On Behaviour. The 'Call Sign/ID' page is currently active, showing a text input field with 'GV_ABCD' and 'Call Sign/ID (max 15 chars)'. Below the input field are 'Apply' and 'Cancel' buttons. A red arrow points from the text 'Call Sign/ID (displayed in brackets)' to the 'GV_ABCD' text in the input field. At the bottom of the interface, there are buttons for 'RF On', 'RF Off', 'Menu', 'Status', 'Logs', 'Local Remove', 'Reset', and 'Log Out'. A small notification box indicates 'Logged in as: Nautel', 'Email configuration not set', and 'Notification added'.

Turn-On Behaviour

The Turn-on Behaviour page (see [Figure 3.2.142](#)) allows users to delay the start-up (RF on) of the transmitter when recovering from an ac power loss, in order to limit the simultaneous power demand from multiple transmitters on a common generator by staggering their turn on sequence.

- ❖ Enter a value for Turn-On Delay in the allowable range of 0-120 seconds, defaulted to 0 seconds (disabled).
- ❖ Enter a value for Ramp-Up Speed in the allowable range of 0-100%, defaulted to 100% (normal).

Press Apply to save the change or Cancel to discard changes.

Figure 3.2.142: Turn-On Delay

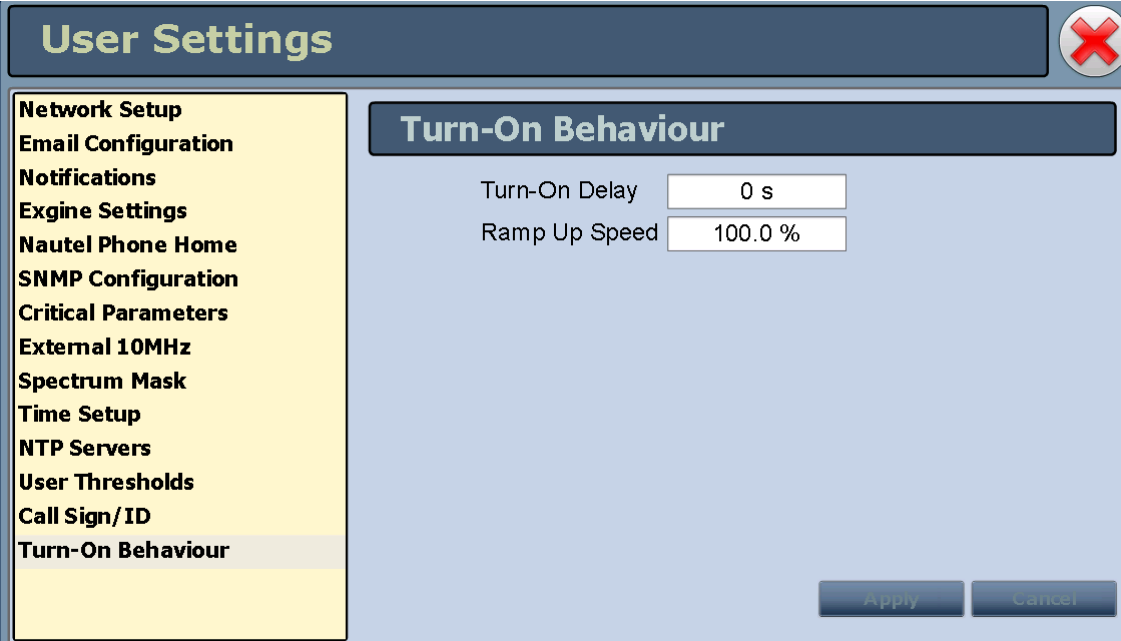

The screenshot shows a 'User Settings' dialog box with a red 'X' close button in the top right corner. On the left is a vertical menu with the following items: Network Setup, Email Configuration, Notifications, Engine Settings, Nautel Phone Home, SNMP Configuration, Critical Parameters, External 10MHz, Spectrum Mask, Time Setup, NTP Servers, User Thresholds, Call Sign/ID, and Turn-On Behaviour (which is highlighted). The main area of the dialog is titled 'Turn-On Behaviour' and contains two input fields: 'Turn-On Delay' with a value of '0 s' and 'Ramp Up Speed' with a value of '100.0 %'. At the bottom right of the dialog are two buttons: 'Apply' and 'Cancel'.

User Settings - Controller UI

You can establish various user settings for the GV5/GV3.5 using the controller's UI. Several User Settings were described previously in this section (e.g., Edit Presets, Set Clock, Network Settings, etc.). The following additional options are available:

- Edit Presets: see [Managing Presets - using the Controller UI, on page 3.2.74](#)
- Set Clock: see [Setting the Clock - Using the Controller UI, on page 3.2.158](#)
- Network Settings: see [Network Setup - Using the Controller UI, on page 3.2.140](#)
- Setting Pilot Sample Level - see page 3.2.167
- Configure Test Signal Generator - see page 3.2.168
- Ext. 10 MHz Input: see [External 10 MHz Input - using the Controller UI, on page 3.2.154](#)
- Scheduler: see [Enabling the Scheduler - Controller UI, on page 3.2.189](#)
- Selecting FM Mask - see page 3.2.170
- Audio Low: see [Setting User Thresholds - using the Controller UI, on page 3.2.163](#)
- Turn-On Delay Setting - see page 3.2.171
- Ramp-Up Speed Setting - see page 3.2.172

Setting Pilot Sample Level

NOTE: Setting the pilot sample is only available using the controller UI.

From the front panel UI, you can set the level of the pilot sample that is applied to the PILOT SAMPLE OUT (A1J4A) BNC connector on the rear of the controller (A4). To view the Pilot Sample screen, select User Settings -> Pilot Sample from the Main Menu (see [Figure 3.2.143](#)).

Figure 3.2.143: Pilot Sample Screen

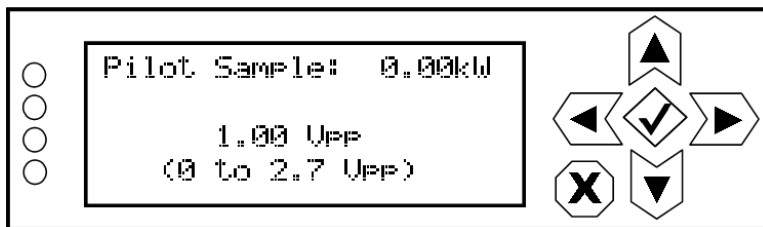

Use the up and down buttons to edit the pilot sample level between 0 and 2.70 V peak-to-peak (in 0.01 V increments). Press the accept (checkmark) button to save the change. Press cancel (X) to discard changes and return to the previous menu.

Configure Test Signal Generator

NOTE: The test signal generator function is only available using the controller UI.

From the controller UI, you can configure the test signal generator output of the GV5/GV3.5. Note that a different menu will appear depending on the currently configured test signal type. To view the Signal Gen screen, select User Settings -> Signal Gen from the Main Menu (see [Figure 3.2.144](#)).



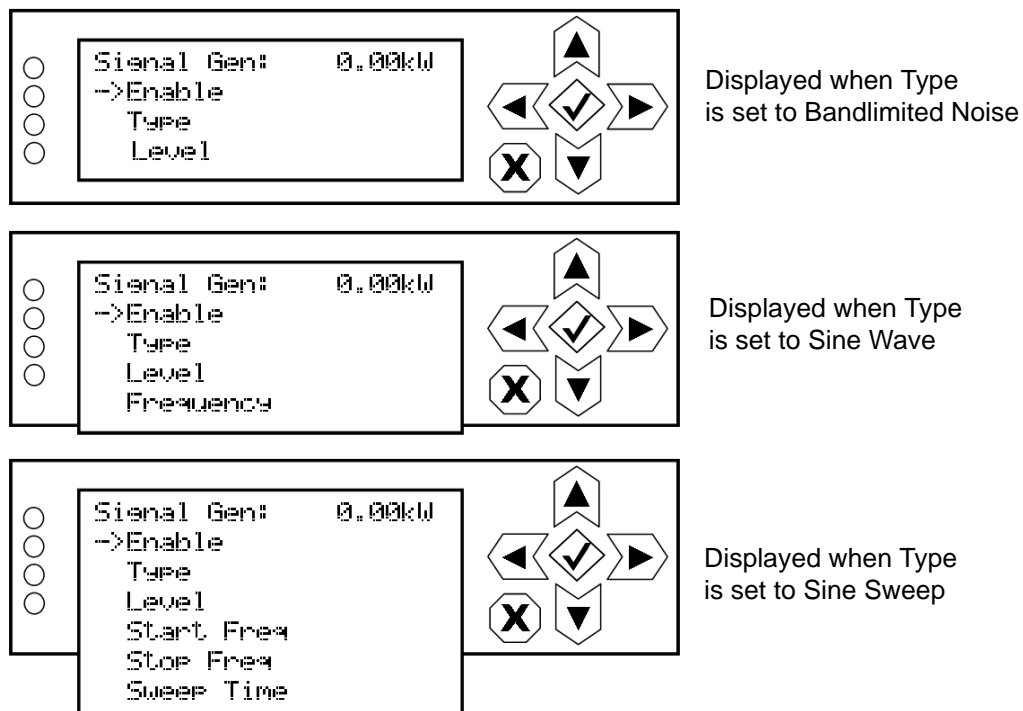
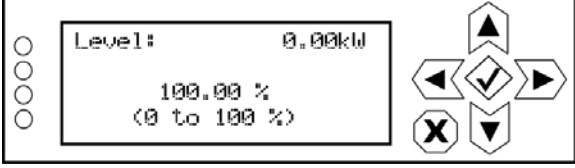

Figure 3.2.144: Signal Generator Menus



Use the up and down buttons to move the cursor to the desired line item and then press the right button to enable editing.

[Figure 3.2.145 on page 3.2.169](#) shows all possible editing screens for the Signal Gen menu. Within any of the editing screens, use the up and down buttons to edit the setting. Press the accept (checkmark) button to save the change. Press cancel (X) to discard changes and return to the previous menu.

Figure 3.2.145: Signal Generator Editing Screens

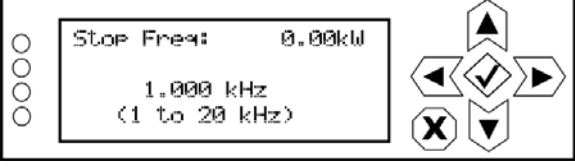
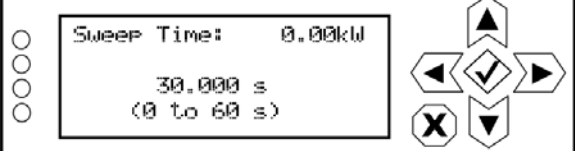
	<p>Select ON (enabled) or OFF (disabled). Press the cancel (X) button to discard changes and return to the previous menu. Default is OFF.</p>
	<p>Select a type - None, Sine Wave, Sine Sweep or Bandlimited Noise. Press the cancel (X) button to discard changes and return to the previous menu.</p>
	<p>Select a level between 0 and 100%. Press the cancel (X) button to discard changes and return to the previous menu. Default is 100%.</p>
	<p>When Type is set to Sine Wave, select a frequency between 0 and 20 kHz. Press the cancel (X) button to discard changes and return to the previous menu. Default is 1 kHz.</p>
	<p>When Type is set to Sine Sweep, select a start frequency between 0 and 20 kHz. Press the cancel (X) button to discard changes and return to the previous menu. Default is 1 kHz.</p>
	<p>When Type is set to Sine Sweep, select a stop frequency between 1 and 20 kHz. Press the cancel (X) button to discard changes and return to the previous menu. Default is 1 kHz.</p>
	<p>When Type is set to Sine Sweep, select a time between 0 and 60 s. Press the cancel (X) button to discard changes and return to the previous menu. Default is 30 s.</p>

Selecting FM Mask

NOTE: FM Mask selection is only available using the controller UI.

From the controller UI, you can select the appropriate FM mask standard (FCC, ETSI or None) being used by the analyzer on the AUI. The selection affects the mask lines on the AUI's Spectrum Analyzer instrument. To view the FM Mask screen, select User Settings -> FM Mask from the Main Menu (see [Figure 3.2.146](#)).

Figure 3.2.146: FM Mask Screen

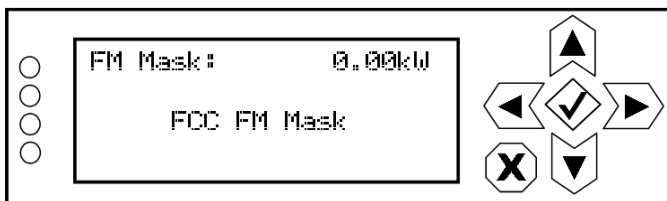

Use the up and down buttons to toggle between FCC FM Mask, ETSI FM Mask and No FM Mask. The factory setting is FCC FM Mask. Press the accept (checkmark) button to save the change. Press cancel (X) to discard changes and return to the previous menu.

Turn-On Delay Setting

NOTE: The turn-on delay setting is only available using the controller UI.

From the controller UI, you can set the transmitter's turn-on delay. This setting determines the time delay for the transmitter to recover from an ac power loss. This is typically used in sites with multiple transmitters on a common generator. By staggering the turn-on delay periods of each transmitter, you can reduce the overall load on the generator. To view the Turn On Delay screen, select User Settings -> Turn On Delay from the Main Menu (see [Figure 3.2.147](#)).

Figure 3.2.147: Turn On Delay Screen

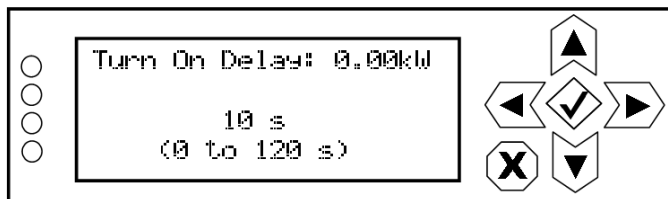

Use the up and down buttons to select a delay between 0 and 120 s (in 1 s increments). The default setting is 0 s (disabled). Press the accept (checkmark) button to save the change. Press X to abort the reset and return to the previous menu.

Ramp-Up Speed Setting

NOTE: The ramp-up speed setting is only available using the controller UI.

From the controller UI, you can set the transmitter's ramp-up speed. This setting establishes the time it takes the transmitter to ramp up from 0 W to full power. At 100%, ramp-up speed is approximately seven seconds. For a setting of 50%, ramp-up would be approximately 14 seconds. For a setting of 25%, ramp-up would be approximately 28 seconds. In multi-transmitter systems that are on a common generator or power grid, adjusting the ramp-up speed can be used to reduce the transient load on the source during an ac power recovery (i.e., after a power failure or changeover to a generator).

To view the Ramp-up Speed screen, select User Settings -> Ramp-up Speed from the Main Menu (see [Figure 3.2.148](#)).

Figure 3.2.148: Ramp-up Speed Screen

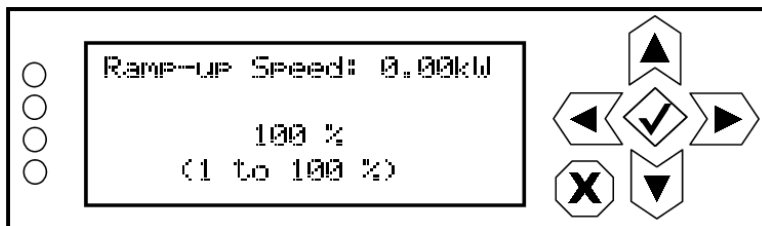

Use the up and down buttons to select a ramp-up speed between 1 and 100% (in 1% increments), noting 100% represents approximately seven seconds (0 W to full power). The default setting is 100% (approximately Press the accept (checkmark) button to save the change. Press X to abort the reset and return to the previous menu.

Configuring Remote Inputs and Outputs

You can configure your remote input/output interface for the transmitter using the AUI (see [Remote I/O Settings - using the AUI](#)) or using the controller UI (see [Remote I/O Settings - using the Controller UI, on page 3.2.179](#)).

Refer also to the GV5/GV3.5 Pre-installation Manual for information on remote inputs and outputs and their factory default settings.

Remote I/O Settings - using the AUI

To view the Remote I/O page (see [Figure 3.2.149](#)), select Remote I/O from the Menu options. Press X in the upper, right corner to close this page and return to the Home page.

Figure 3.2.149: Remote I/O Page - Remote Inputs tab selected

The screenshot displays the Remote I/O configuration interface. At the top, the 'Date & Time' section shows 'Thu Aug 14 2014' and '14:52:27'. The 'Transmitter' section displays '0.01 kW' and 'Set Point 22.00 kW'. The 'Exciter' section shows 'Active Exciter A' and 'FM Modulation' at 0.010%. The 'Remote I/O' window is open, with the 'Remote Inputs' tab selected. The list of inputs includes 'Remote Input 1' (Custom Input), 'Remote Input 2' (Not Assigned), 'Remote Input 3' (Inc/Dec RF Power), 'Remote Input 4' (Inc/Dec RF Power), 'Remote Input 5' (Preset: Preset 1), 'Remote Input 6' (Reset), 'Remote Input 7' (Preset: FM_HD), 'Remote Input 8' (Main Exciter), and 'Remote Input 9'. The configuration panel for 'Remote Input 1' shows: Channel: Custom Input, Control: Active Low, Turn On, Level: 1, Name: Custom Input 1, Severity: Low, and Log: unchecked. The bottom status bar shows 'RF On' and 'RF Off' buttons, 'Logged in as: Nautel', and navigation buttons: 'Menu', 'Status', 'Logs', 'Local/Remote', 'Reset', and 'Log Out'.

Select the Remote Inputs tab (see [Digital I/O Inputs - AUI, on page 3.2.173](#)) or Remote Outputs tab (see [Digital I/O Outputs - AUI, on page 3.2.175](#)) to view or edit detail on the digital inputs or outputs.

Remote Inputs - AUI

Using the Remote Inputs tab (see [Figure 3.2.149 on page 3.2.173](#)), you can configure up to 10 digital inputs that allow you to remotely control various operational characteristics of the transmitter. Unless otherwise noted, these inputs are only accepted by the transmitter if the remote/local status is set to remote. That setting can only be made by a local user using the AUI's Local button. Nautel sets digital input defaults prior to shipping. See the Pre-installation Manual for details.

Select the desired digital input (1 through 10) from the list. The Channel and Control settings for the selected input, as well as the current logic level (1 or 0), are displayed on the right-hand side of the page. You can define the Channel and Control settings as follows:

SELECT INPUT CHANNEL - AUI

You can configure digital inputs 1 through 10 for one of a variety of control inputs. Press the existing Channel bar to display the Select a Remote window (see [Figure 3.2.150 on page 3.2.175](#)). From this window select one of the following options by pressing OK:

- ❖ Not Assigned. No effect on transmitter operation, regardless of logic level.
- ❖ RF On/Off. Same as pressing the RF On (telling the system to provide RF power, if possible) or the RF Off button on the local AUI. There are two inputs configured by default; one for Falling Edge, Turn On and one for Falling Edge, Turn Off.
- ❖ Reset. Causes a system reset. Same as pressing Reset button on the local AUI.
- ❖ Force ARM Reset. Allows the user to force an ARM reset to the AUI, thus rebooting the AUI via a hardware parallel remote input (controlled by a third party remote control unit).
- ❖ Main Exciter. Selects the main exciter to operate the transmitter. There are two inputs configured by default; one for Falling Edge, Set to A and one for Falling Edge, Set to B.
- ❖ Auto Changeover Enabled. Sets the exciter changeover function to operate automatically. There is only one input configured by default; each subsequent activation of the input will toggle the state (enabled/disabled) e.g. Falling Edge, Toggle.
- ❖ Inc/Dec RF Power. Activating these inputs will increment/decrement the preset power level by 1% of the rated power. Holding the selection will increment/decrement the power level by 1% every 1/2 second. There are two inputs configured by default; one for Falling Edge, Increase and one for Falling Edge, Decrease. **NOTE:** If multiple power increase or decrease inputs are active, the lower number input takes precedence.
- ❖ Preset: NAME. Selects the associated preset (from a list of all pre-defined presets) as active.

If you save a change to a digital input via the AUI, it will also be displayed on the controller UI.

Figure 3.2.150: Select a Remote (input) window

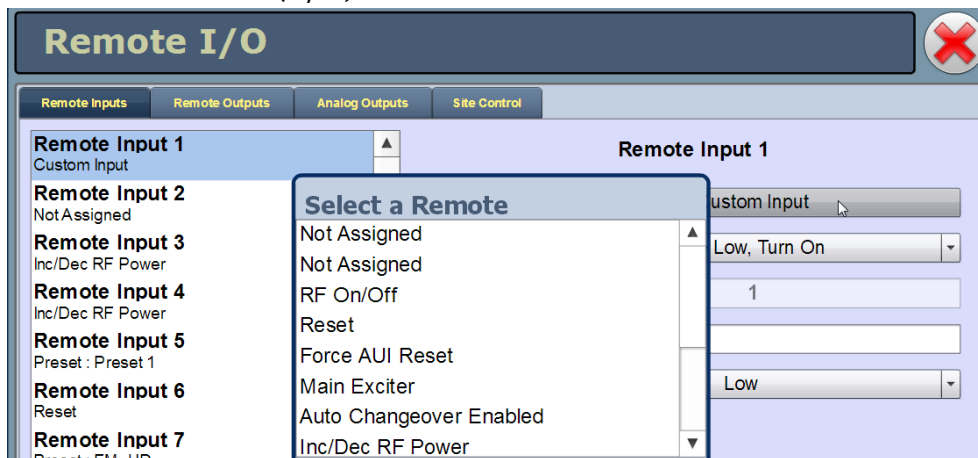

CONFIGURE INPUT CONTROL LOGIC - AUI

You can configure the active/inactive control logic for each of the 10 digital inputs. Press the existing Logic bar to display the applicable drop-down menu options, which may include:

- ❖ Rising Edge Turn On/Reset. Logic '1' (high or rising edge) activates the input (or causes a reset, as appropriate).
- ❖ Falling Edge Turn On/Reset. Logic '0' (low or trailing edge) activates the input (or causes a reset, as appropriate).
- ❖ Rising Edge Turn Off. Logic '1' (high or rising edge) de-activates the input.
- ❖ Falling Edge Turn Off. Logic '0' (low or trailing edge) de-activates the input.
- ❖ Falling Edge Toggle. Logic '0' (low or trailing edge) de-activates the input; next logic '0' (low or trailing edge) activates the input.
- ❖ Rising Edge Toggle. Logic '1' (high or rising edge) activates the input; next logic '1' (high or rising edge) de-activates the input.
- ❖ Rising Edge, Turn On. Falling Edge Turn Off. Logic '1' (high or rising edge) activates the input; logic '0' (low or trailing edge) de-activates the input.
- ❖ Falling Edge, Turn On. Rising Edge Turn Off. Logic '0' (low or trailing edge) activates the input; logic '1' (high or rising edge) de-activates the input.
- ❖ Active High, Increase/Turn On. Logic '1' (high) causes a power increase/activates preset.
- ❖ Active Low, Increase/Turn On. Logic '0' (low) causes a power increase/activates preset.
- ❖ Active High, Decrease. Logic '1' (high) causes a power decrease.
- ❖ Active Low, Decrease. Logic '0' (low) causes a power decrease.

Press Apply to activate changes. Press Cancel to cancel changes.

Remote Outputs - AUI

Using the Remote Outputs tab (see [Figure 3.2.151 on page 3.2.176](#), you can configure up to 16 digital outputs that indicate either the presence of various alarms or the status of operator controlled circuits.

Nautel sets digital output defaults prior to shipping. See the GV5/GV3.5 Pre-installation Manual for details.

Figure 3.2.151: Remote I/O Page - Remote Outputs tab selected

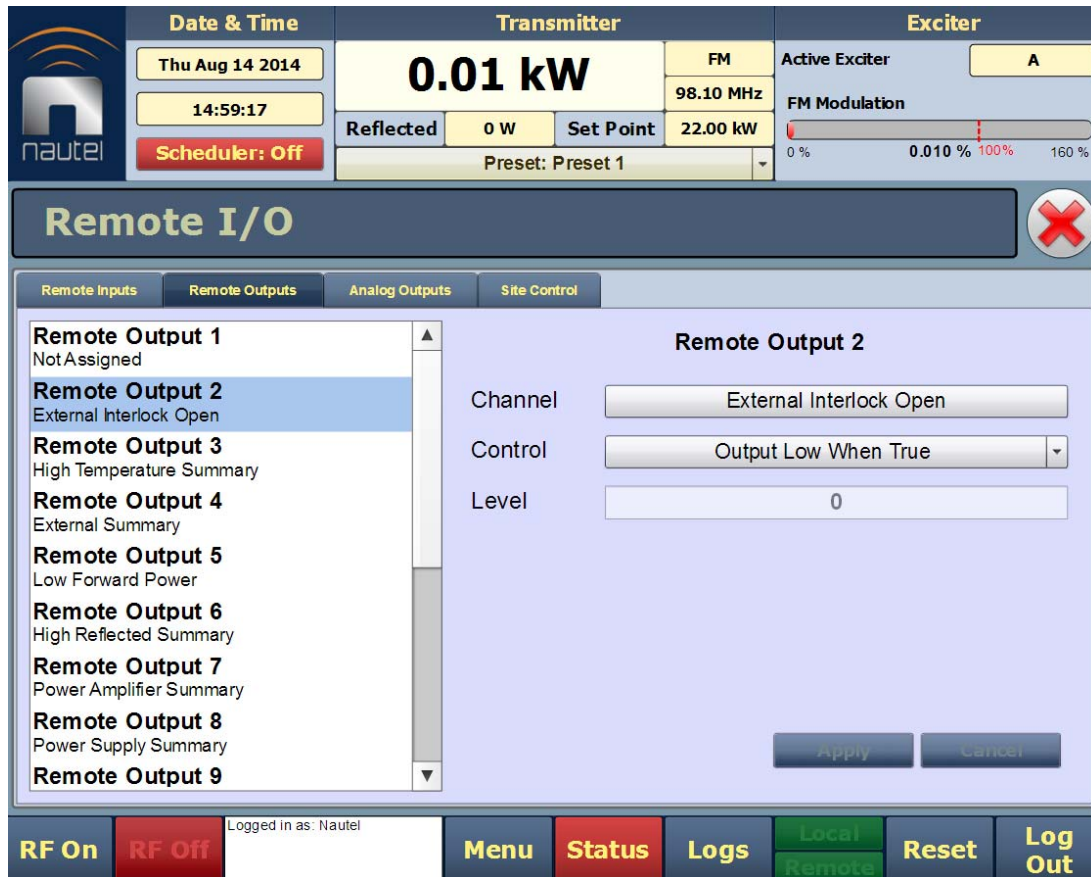

Select the desired digital output (1 through 16) from the list. The Channel and Control settings for the selected output, as well as the current logic level (1 or 0), are displayed on the right-hand side of the page. You can define the Channel and Control settings as follows:

SELECT OUTPUT CHANNEL - AUI

You can configure digital outputs 1 through 16 to monitor a variety of alarm and status outputs. Press the existing Channel bar to display the Select a remote window (see [Figure 3.2.152](#)). From this window, select one of the channels, then click OK to accept:

- ❖ Not Assigned. No alarm or status parameter is monitored.
- ❖ Local/Remote. The active logic level indicates the transmitter is in local control. The inactive logic level indicates the transmitter is in remote control.
- ❖ RF On/Off. The active logic level indicates the transmitter's RF power stage is on (enabled). The inactive logic level indicates the transmitter's RF power stage is off.
- ❖ Preset Status (1-3 default). The active preset's output will be indicated by a logic low. The remaining, non-active preset outputs will be open collector.
- ❖ Active Exciter. The active exciter's output will be indicated by a logic low. The other, non-active exciter output (as applicable), will be open collector.
- ❖ Auto Changeover Enabled. The active logic level indicates that auto changeover is enabled. The inactive logic level indicates that auto changeover is disabled.
- ❖ Various Alarms. The active logic level indicates that the selected alarm is occurring. Any transmitter alarm can be selected as a digital output. Refer to the GV5/GV3.5 Troubleshooting Manual for a description of each alarm.

Figure 3.2.152: Select a Remote (output) window

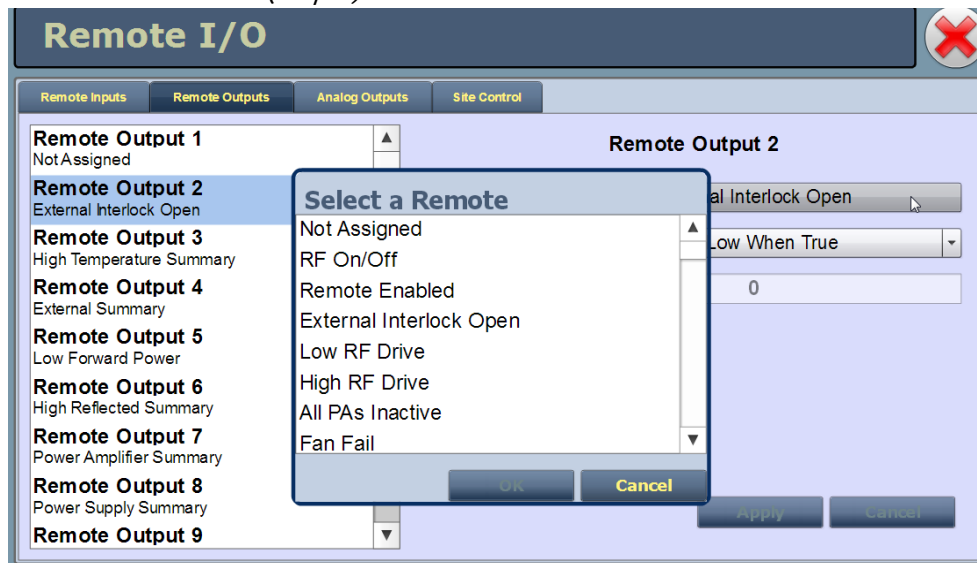

CONFIGURE OUTPUT LOGIC - AUI

You can configure the active/inactive logic for each of the 16 digital outputs. Press the existing Logic bar to display the applicable drop-down menu options. Some digital output default examples:

If the selected channel is RF On/Off, the drop-down options are:

- Output Low When RF On. Logic '0' (low) indicates the output is true (RF is on); Logic '1' (high) indicates the output is false (RF is off).
- Output Low When RF Off. Logic '0' (low) indicates the output is true (RF is off); Logic '1' (high) indicates the output is false (RF is on).

If the selected channel is Local/Remote, the drop-down options are:

- Output Low When Local. Logic '0' (low) indicates the output is true (Local); Logic '1' (high) indicates the output is false (Remote).
- Output Low When Remote. Logic '0' (low) indicates the output is true (Remote); Logic '1' (high) indicates the output is false (Local).

If the selected channel is Active Exciter, the drop-down options are:

- Output Low When A. Logic '0' (low) indicates the output is true (A); Logic '1' (high) indicates the output is false (B).
- Output Low When B. Logic '0' (low) indicates the output is true (B); Logic '1' (high) indicates the output is false (A).

if the selected channel is Auto Changeover Enabled, the drop-down options are:

- Output Low When Enabled. Logic '0' (low) indicates the output is true (Enabled); Logic '1' (high) indicates the output is false (Disabled).
- Output Low When Disabled. Logic '0' (low) indicates the output is true (Disabled); Logic '1' (high) indicates the output is false (Enabled).

if the selected channel is Preset: Preset 1, the drop-down options are:

- Output Low When Active. Logic '0' (low) indicates the output is true (Active); Logic '1' (high) indicates the output is false (Inactive).
- Output Low When Inactive. Logic '0' (low) indicates the output is true (Inactive); Logic '1' (high) indicates the output is false (Active).

Press Apply to activate changes. Press Cancel to cancel changes.

Remote I/O Settings - using the Controller UI

To view the Remote I/O screen (see [Figure 3.2.153](#)) on the controller UI, select Remote I/O from the Main Menu.

Figure 3.2.153: Remote I/O screen

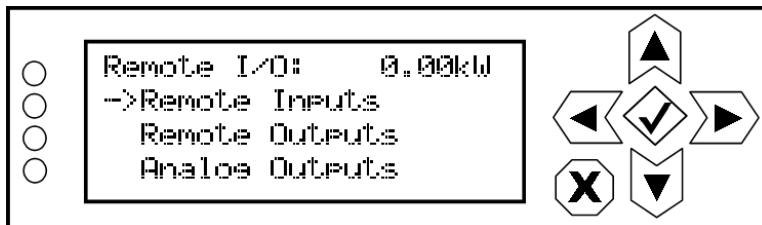

Use the up and down buttons to select Remote Inputs (see [Digital Inputs - Controller UI](#)), Remote Outputs (see [Digital Outputs - Controller UI](#), on page 3.2.181) or Analog Outputs (see [Monitoring Analog Outputs](#), on page 3.2.182) to view or edit detail on the selected inputs or outputs.

Digital Inputs - Controller UI

Using the Remote Inputs screens (see [Figure 3.2.154 on page 3.2.180](#)), you can configure up to 10 digital inputs that allow you to remotely control various operational characteristics of the transmitter. Unless otherwise noted, these inputs are only accepted by the transmitter if remote control is enabled. That setting can only be made by a local user using the front panel AUI.

Nautel sets digital input defaults prior to shipping. See the GV5/GV3.5 Pre-installation Manual for details.

Figure 3.2.154: Remote Inputs Screens (Input 1 shown)

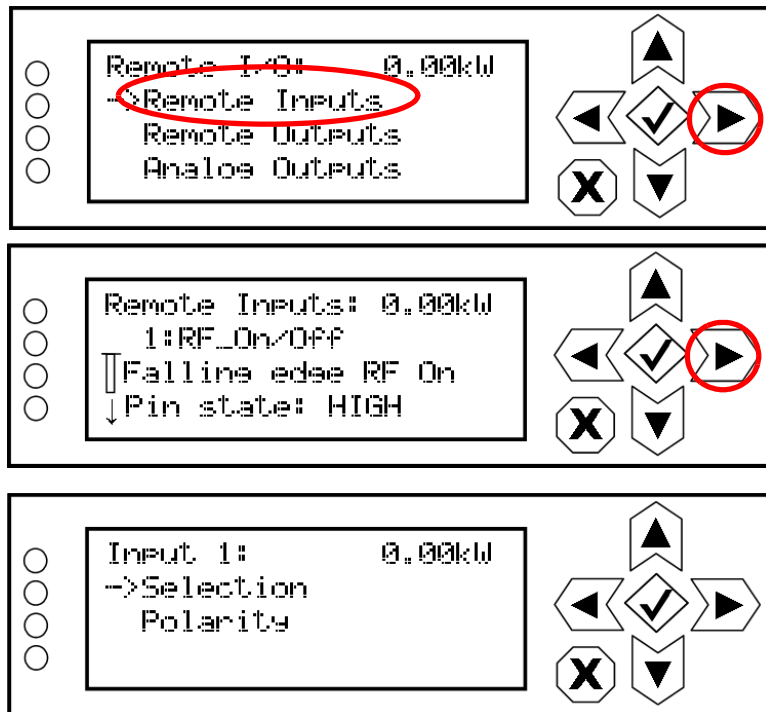

Use the up and down buttons to select the desired digital input (1 through 10) from the list. Each screen shows the current digital input parameter (e.g., RF On/Off), as well as the polarity (e.g., Falling edge RF On) and current state (e.g., high, low) of the corresponding input pin. Use the right-arrow button to enter the Selection/Polarity screen for the selected input to allow editing of the selection or the polarity. Press cancel (X) to return to the previous menu.

If you save a change to a digital input via the controller UI, it will also be displayed on the AUI page.

NOTE: The selection and polarity options for digital inputs are the same as described in [Select Input Channel - AUI, on page 3.2.174](#) and [Configure Input Control Logic - AUI, on page 3.2.175](#).

Digital Outputs - Controller UI

Using the Remote Outputs screens (see [Figure 3.2.154 on page 3.2.180](#)), you can configure up to 16 digital outputs that indicate either the presence of various alarms or the status of operator controlled circuits.

Nautel sets digital output defaults prior to shipping. See the GV5/GV3.5 Pre-installation Manual for details.

Figure 3.2.155: Remote Outputs Screens (Output 1 shown)

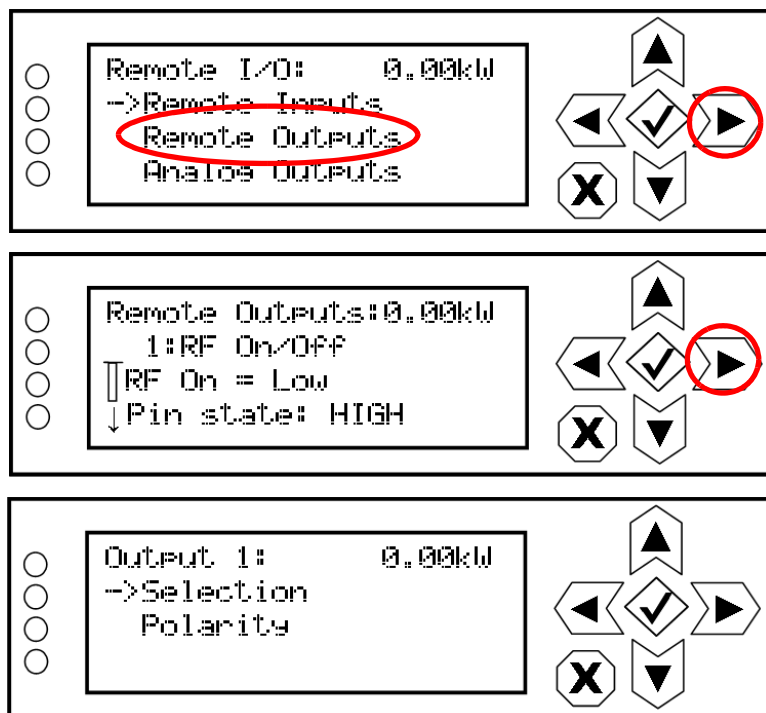

Use the up and down buttons to select the desired digital output (1 through 16) from the list. Each screen shows the current digital output parameter (e.g., RF On/Off), as well as the polarity (e.g., RF On = Low) and current state (e.g., high, low) of the corresponding output pin. Use the right-arrow button to enter the Selection/Polarity screen for the selected output to allow editing of the selection or the polarity. Press cancel (X) to return to the previous menu.

If you save a change to a digital output via the controller UI, it will also be displayed on the AUI page.

NOTE: The selection and polarity options for digital outputs are the same as described in [Select Output Channel - AUI, on page 3.2.177](#) and [Configure Output Logic - AUI, on page 3.2.178](#).

Monitoring Analog Outputs

You can monitor the levels of four factory set analog outputs using the AUI (see [Analog Outputs - AUI](#)) or using the controller UI (see [Analog Outputs - Controller UI, on page 3.2.183](#)).

Nautel sets analog output defaults prior to shipping. There are no user configuration options. They are for monitoring purposes only. See the GV5/GV3.5 Pre-installation Manual for details.

Analog Outputs - AUI

Select the Analog Outputs tab to view the analog outputs (see [Figure 3.2.156](#)) for the pre-determined parameters. There are columns that list the Full Scale Voltage and corresponding Full Scale Value as well as the Current Voltage and corresponding Current Value.

Figure 3.2.156: Remote I/O Page - Analog Outputs tab selected

The screenshot shows the 'Remote I/O' interface with the 'Analog Outputs' tab selected. The top section displays transmitter and exciter status. The transmitter is set to 0.01 kW, with a reflected power of 0 W and a set point of 22.00 kW. The exciter is active (A) and the FM modulation is at 0.010%.

Name	Full Scale Voltage	Full Scale Value	Current Voltage	Current Value
1 Forward Power	6.000 V	24000 W	0.000 V	0.011 kW
2 Reflected Power	6.000 V	2400 W	0.000 V	0 W
3 PA Voltage	6.000 V	60 V	0.196 V	1.918 V
4 Total PA Current	6.000 V	960 A	0.000 V	0 A

At the bottom of the interface, there are buttons for 'RF On', 'RF Off', 'Menu', 'Status', 'Logs', 'Local Remote', 'Reset', and 'Log Out'. The user is logged in as 'Nautel'.

Analog Outputs - Controller UI

Using the Analog Outputs screens (see [Figure 3.2.157 on page 3.2.183](#)), you can view the levels of WfC pre-defined analog outputs that are representative of critical transmitter parameters.

Nautel sets analog output defaults prior to shipping. There are no configuration options. They are for monitoring purposes only. See the GV5/GV3.5 Pre-installation Manual for details.

Figure 3.2.157: Analog Outputs Screens

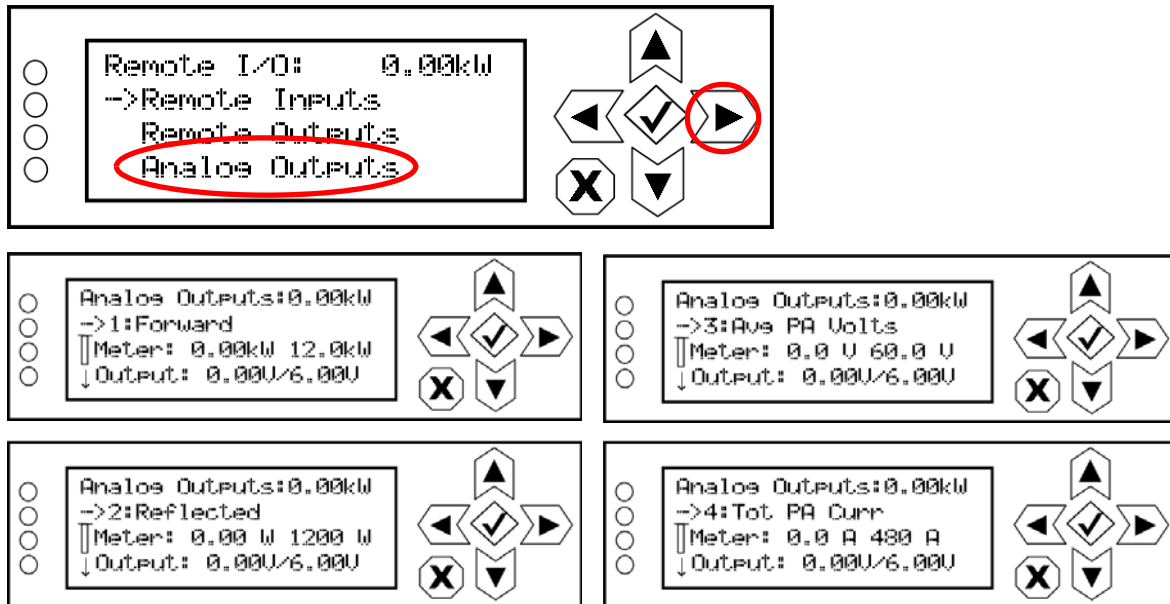

Use the up and down buttons to select the desired analog output (1 through 4) from the list. Each screen shows the analog output parameter (e.g., Forward Power, Reflected Power, Avg PA Volts or Total PA Current), as well as the meter reading (actual and full-scale) and the output pin voltage (actual and full-scale). Press cancel (X) to return to the previous menu.

NOTE: The analog output's Output voltage reading reflects the value that can be measured at the associated remote analog output pin for the given Meter value. See the Pre-installation Manual for actual remote analog output pin assignments.

Site Control Settings

You can use the AUI's Site Control page (see [Figure 3.2.158](#)) to locally or remotely configure remote inputs and outputs for use with external site control equipment (air conditioner, etc.). This page allows the user to create and configure custom digital inputs and outputs and assign them for use using the Remote Inputs and Remote Outputs pages.

To view this page, select Remote I/O from the Menu options and select the Site Control tab. Press X in the upper, right corner to close this page and return to the Home page.

Figure 3.2.158: Remote I/O Page - Site Control



Adding or Editing a Site Control Rule

Selecting the Add or Edit button displays the rule editing window (see [Figure 3.2.159](#) on page 3.2.185) for site control inputs and outputs. This window allows you to create a new site control rule or edit an existing one. Each custom input or output can be assigned a name, severity level and trigger parameters (active state and time delay). Each rule can also be set to latch (i.e., requiring a reset) or log with the rest of the transmitter's alarm and status signals, upon its occurrence. You can use Boolean logic expressions to perform 'AND', 'OR' and 'XOR' (exclusive OR) functions on multiple inputs or rules.

Use the Edit Site Control Rule window as follows:

Figure 3.2.159: Site Control Rule Editing Window

The screenshot shows the 'Edit Site Control Rule' dialog box. The dialog has the following fields and controls:

- Name:** High Temp (Air Cond On)
- Severity:** Medium (dropdown menu)
- Delay:** Immediate (dropdown menu)
- Latch:** (checkbox)
- Log:** (checkbox)
- Input section:**
 - Row 1: Input: Active Exciter:High PATemperature, Logic: Is True, Operator: OR
 - Row 2: Input: Controller:High Splitter Temperature, Logic: Is True
- Buttons:** Apply, Cancel

The background interface shows a table with the following columns: Severity, Latch, Log, Delay, Triggered When. The table contains one row with the following values: Medium, , , Immediate, Active Exciter:High PATemperature Is True OR Controller:High Splitter Temperature.

- ❖ In the Name section, enter a name for the rule. This will display on the Site Control page, as well the Logs page, when triggered.
- ❖ In the Severity section, use the drop-down menu to select Low, Medium or High. The selected severity level will display on the Status page and Events Log. See [Figure 3.2.14 on page 3.2.29](#) for a description of the severity levels for logged events.
- ❖ In the Delay section, use the drop-down menu to select the time delay after activation that the site control rule will take effect (i.e., be asserted). Select Immediate, 1 Sec, 2 Sec, 5 Sec, 10 Sec, 30 Sec or 60 Sec .
- ❖ Check the Latch check-box if you want the assertion of the rule to require a reset. If not, leave the box unchecked.
- ❖ Check the Log check-box if you want the assertion of the rule to display an alarm and log the event. If not, leave the box unchecked.

-
- ❖ In the Input section, use the drop-down menu to select the desired input (alarm, status or custom input) that will affect the rule. Note that a second input may also be selected in conjunction with a logic operation if the Operator section contains the AND, OR or XOR function.
 - ❖ In the Logic section, use the drop-down menu to select "Is True" or "Is False" to indicate the trigger for the assertion of the rule. Select "Is True" when you want the rule to assert when the associated input is active. Select "Is False" when you want the rule to assert when the associated input is inactive.
 - ❖ In the Operator section, use the drop-down menu to select a logic operation to combine two inputs. Select "blank" for no logic operation (i.e., for single input rules). For rules that use two inputs, select AND, OR or XOR, noting:
 - the AND function requires both inputs to be asserted (according to their selected Logic states) to activate the rule.
 - the OR function requires one or both inputs to be asserted (according to their selected Logic states) to activate the rule.
 - the XOR function requires one - and only one - input to be asserted (according to their selected Logic states) to activate the rule.
 - ❖ Press the Apply button to save the rule or the Cancel button to return to the Site Control page.

The Site Control page will display all rules, with the user-defined characteristics described above. Additionally, the current State of the rule will be displayed in a check-box on the right-hand side of the page. A checked box indicates the rule is currently active.

Applying a Site Control Rule to a Remote Input/Output

You can apply a site control rule as a Remote Output by selecting the desired rule from the Channel list in either the Remote I/O tab. The Channel list should contain the names of all existing rules. See [Remote I/O Settings - using the AUJ, on page 3.2.173](#) for more details on configuring remote inputs and outputs.

Custom remote inputs can be created in the Remote Inputs tab. These inputs can be used within a site control rule.

Preset Scheduler

If the scheduler is enabled (see [Enabling the Scheduler on page 3.2.189](#)), you can program a yearly preset schedule for the transmitter. Use the Scheduler page (see [Figure 3.2.160](#)) to set the dates and times at which presets take effect. You can define as many different schedules as you desire. To view the Scheduler page, select Scheduler from the Menu options.

Figure 3.2.160: Scheduler page

The screenshot displays the Nautel Scheduler interface. At the top, the transmitter status is shown as **0 kW** with a **Set Point** of **2.00 kW**. The active exciter is **A** and the FM modulation is at **0.010 %**. The scheduler is currently **Off**. Below this, the Scheduler page features a monthly calendar for March 2014. The calendar shows dates from 16 to 19, with the 1st of April also visible. To the right of the calendar are sections for **Rules** and **Daily Events**, both currently empty. At the bottom, there are navigation buttons for **RF On**, **RF Off**, **Menu**, **Status**, **Logs**, **Local**, **Remote**, **Reset**, and **Log Out**. The user is logged in as **Nautel**.

The left-hand side of the Scheduler page displays a monthly calendar (e.g., March 2014). Use the << and >> buttons to navigate between months. Use the < and > buttons to navigate to the beginning and the end of the schedule.

The right-hand side of the Scheduler page contains a Rules section and a Daily Events section. Selecting a specific date in the monthly calendar displays the rules and daily events, as applicable, for that day.

Figure 3.2.161: Rule Explorer window

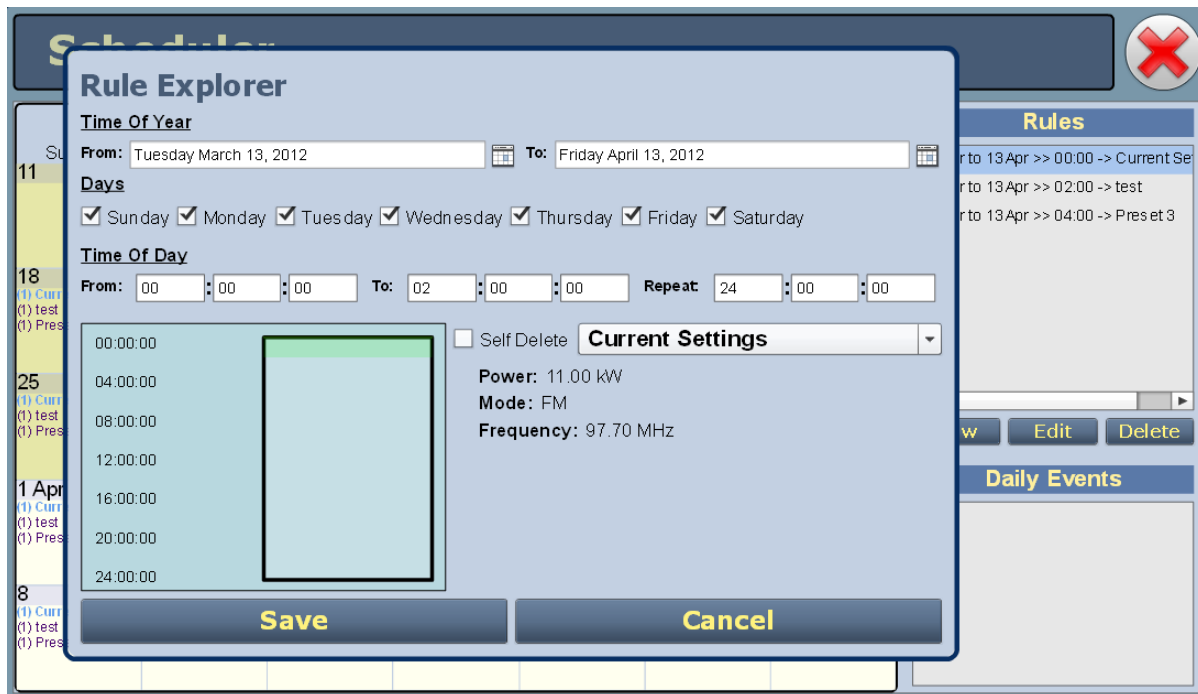

When you press in the Rules list, you have the option to edit or delete an existing rule, or to create a new rule. Select the New or Edit button to display the Rule Explorer window (see [Figure 3.2.161](#)). Press Delete to remove a rule from the list.

Use the Rule Explorer window as follows:

- ❖ In the Time of Year section, set the start (From:) and end (To:) dates for the rule. Start to end dates must be less than one year apart.
- ❖ In the Days section, select the days of the week on which the rule will apply.
- ❖ In the Time of Day section, set the start (From:) and end (To:) times (hours, minutes and seconds) for the rule. Use the Repeat: field to establish a repeating cycle for the rule (e.g., every 24 hours).
- ❖ Use the drop-down menu to select the preset (e.g., Current Settings) for the rule. The preset's power, mode and frequency are displayed below the preset.
- ❖ Unless you edit other rules first, you cannot select a date that occurs before the start of the previous rule or after the start of the following rule.
- ❖ Press the Save button to store the rule in the scheduler or the Cancel button to return to the Scheduler page.

Enabling the Scheduler

You can enable or disable the scheduler using the AUI (see [Enabling the Scheduler - AUI](#)) or using the controller UI (see [Enabling the Scheduler - Controller UI](#)).

Enabling the Scheduler - AUI

Enable or disable the scheduler by pressing the Scheduler button in the Date & Time section (see [Figure 3.2.162](#)).

Figure 3.2.162: Enabling/disabling the scheduler - AUI

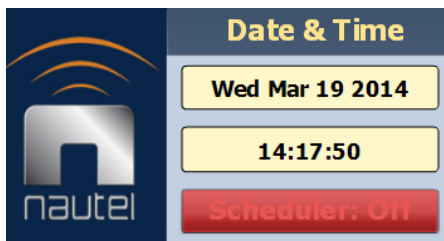

When Scheduler: ON appears, the transmitter will follow the Scheduler settings.

When Scheduler: OFF appears, the transmitter will stop following the schedule and the active preset will be the preset that was operating when the scheduler was disabled.

Enabling the Scheduler - Controller UI

To view the Scheduler enable/disable screen (see [Figure 3.2.163](#)) on the front panel display, select User Settings -> Scheduler from the Main Menu.

Figure 3.2.163: Enabling/disabling the scheduler - Front Panel

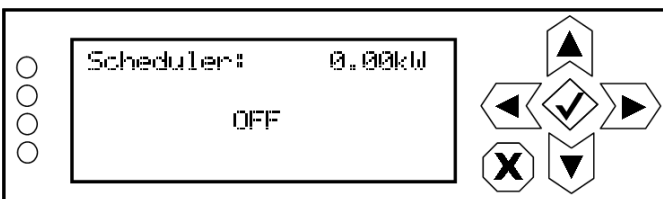

Use the up and down buttons to select ON (enable) or OFF (disable). The default setting is OFF. Press cancel (X) to return to the previous menu.

Audio Player

The built-in audio player (see [Figure 3.2.162](#)) can use a file playlist, Livewire or Icecast/Shoutcast as an audio source. These sources must be configured before they can be used. This section describes how to configure audio player sources. To view the Audio Player page, select Audio Player from the Menu options. The Audio Player page has two selectable tabs:

- [Playlist](#) - see page 3.2.191
- [Streams](#) - see page 3.2.193

Figure 3.2.164: Audio Player page - Playlist tab shown

The screenshot displays the Audio Player interface with the following components:

- Top Bar:**
 - Date & Time:** Wed Aug 6 2014, 09:43:00, Scheduler: Off
 - Transmitter:** 0.01 kW, FM, 98.10 MHz, Reflected 0 W, Set Point 10.00 kW, Preset: *Preset 1
 - Exciter:** Active Exciter A, FM Modulation 0.010%
- Audio Player Section:**
 - Buttons: Playlists, Streams, Manage Files
 - Tables:
 - Playlists:** Columns: Type, Name
 - Playlist Contents:** Columns: #, Path
 - Available Files on USB:** Column: Path
 - Buttons: Add, Delete, Insert JMP, Delete, Add File, Refresh
- Bottom Bar:**
 - RF On, RF Off, Logged in as: Nautel
 - Menu, Status, Logs, Local/Remote, Reset, Log Out

The playlist (or Shoutcast/Livewire stream) is typically used as an audio loss backup. For example, the user may operate with Preset 1 using one of the standard audio sources. Preset 1 can be configured to switch to another preset (e.g., Preset 2), which uses a playlist or stream, if Preset 1 loses its audio. See [Configuring a Mod Loss Backup Preset](#), on page 3.4.4 for more information.

Playlist/stream presets can also be activated by the Scheduler (see [Preset Scheduler](#), on page 3.2.187).

Playlist

The Playlist tab (see [Figure 3.2.162](#)) displays the audio files and sequence that currently make up the playlist. Only audio files that are supported (e.g., .wav or .mp3 files) will be played. For .mp3 files, using files with bit rates equal to or less than 96 kbps achieves best audio results. Also, you must activate a preset that has Playlist selected in the Main Audio -> Secondary Digital -> Secondary Source in the Presets menu. There are three sections in the Playlist tab - Playlists, Playlist Contents and Available Files on USB.

Figure 3.2.165: Managing Playlist files

The screenshot displays the Nautel transmitter control interface. At the top, there are three main sections: **Date & Time**, **Transmitter**, and **Exciter**.

- Date & Time:** Shows "Wed Aug 6 2014" and "09:43:00". A red button indicates "Scheduler: Off".
- Transmitter:** Displays "0.01 kW" and "FM". Below this, it shows "Reflected 0 W" and "Set Point 10.00 kW". A dropdown menu shows "Preset: *Preset 1".
- Exciter:** Shows "Active Exciter A" and "FM Modulation" with a progress bar ranging from 0% to 160%, currently at 0.010%.

The main area is titled **Audio Player** and contains three tabs: **Playlists**, **Streams**, and **Manage Files**. The **Playlists** tab is active and shows three sub-sections:

- Playlists:** A table with columns "Type" and "Name".
- Playlist Contents:** A table with columns "#", "Path", and "Delete".
- Available Files on USB:** A table with a "Path" column.

Below these tables are buttons for "Add", "Delete", "Insert JMP", and "Delete" (for the Playlist Contents table). To the right are "Add File" and "Refresh" buttons.

At the bottom of the interface, there are buttons for "RF On", "RF Off", "Menu", "Status", "Logs", "Local Remote", "Reset", and "Log Out". The "Logged in as: Nautel" text is visible next to the "Status" button.

NOTE: You should not change an active (playing) playlist nor should you attempt to delete or move a song that is currently playing. To make changes to the playlist, the audio player must be off (inactive) - or at least not being used as the active preset's source.

The Playlists section is used for adding (Add button) and deleting (Delete button) playlists.

The Playlist Contents section is used for inserting jumps (Insert JMP button) and deleting playlist contents (Delete button). The Insert JMP button allows the user to set up a playlist that can jump to an item in another playlist. You can drag files up and down the Playlist Contents list and you can drag files from the Available Files on USB list to the Playlist Contents list.

The Available Files on USB section is used for adding audio files to the playlist (Add Files button) or refreshing the playlist (Refresh button) . Audio files must be stored on an external USB device plugged into the USB 3 or USB 4 connector on the rear of the controller; they are not stored in the transmitter. Only the audio files stored in the root directory of the most recently connected USB device appear on the playlist. The list will be empty if no USB device is connected. The USB drive must be formatted with a FAT32 file system. Click the Refresh button to force an update of the list of files on the mounted USB.

NOTE: MPEG Layer-3 audio coding technology licensed from Fraunhofer IIS and Thomson.

The audio player supports only one USB device at a time. If multiple USB devices are connected, only the most recently connected USB is recognized as the active USB drive. If multiple USB devices are connected and one is removed, both devices are unmounted.

The Manage Files button displays a pop-up window that allows the user to Browse for files and Upload them to the USB or Delete them from the USB. You should not delete files that are part of more than one playlist.

Figure 3.2.166: Audio Player page - Streams tab

The screenshot displays the 'Audio Player' interface with the 'Streams' tab selected. The top section shows transmitter parameters: Date & Time (Wed Aug 6 2014, 09:46:11), Transmitter (0.01 kW, 98.10 MHz, 10.00 kW), and Exciter (Active Exciter A, FM Modulation 0.010%). Below this is the 'Audio Player' header with a close button. The 'Streams' tab is active, showing a table with the following data:

Name	Details	Type
leah test	Channel. 2	Livewire
leah 2	URL: http://yp.shoutcast.com/sbin/tunein-station.pls?id=914897	Icast/Shoutcast

At the bottom of the table are buttons for 'Add', 'Edit', and 'Delete'. The bottom navigation bar includes buttons for 'RF On', 'RF Off', 'Menu', 'Status', 'Logs', 'Local Remote', 'Reset', and 'Log Out'. The user is logged in as 'Nautel'.

Streams

The GV5/GV3.5 is capable of playing audio streams in either Icast/Shoutcast or Livewire format.

The audio player supports Icast/Shoutcast playlists and IP addresses for audio streams. For an Icast/Shoutcast playlist enter the URL for the station. For an audio stream, enter the URL for that stream.

For Livewire, enter the channel that contains the desired audio.

Figure 3.2.167: Adding Audio Streams

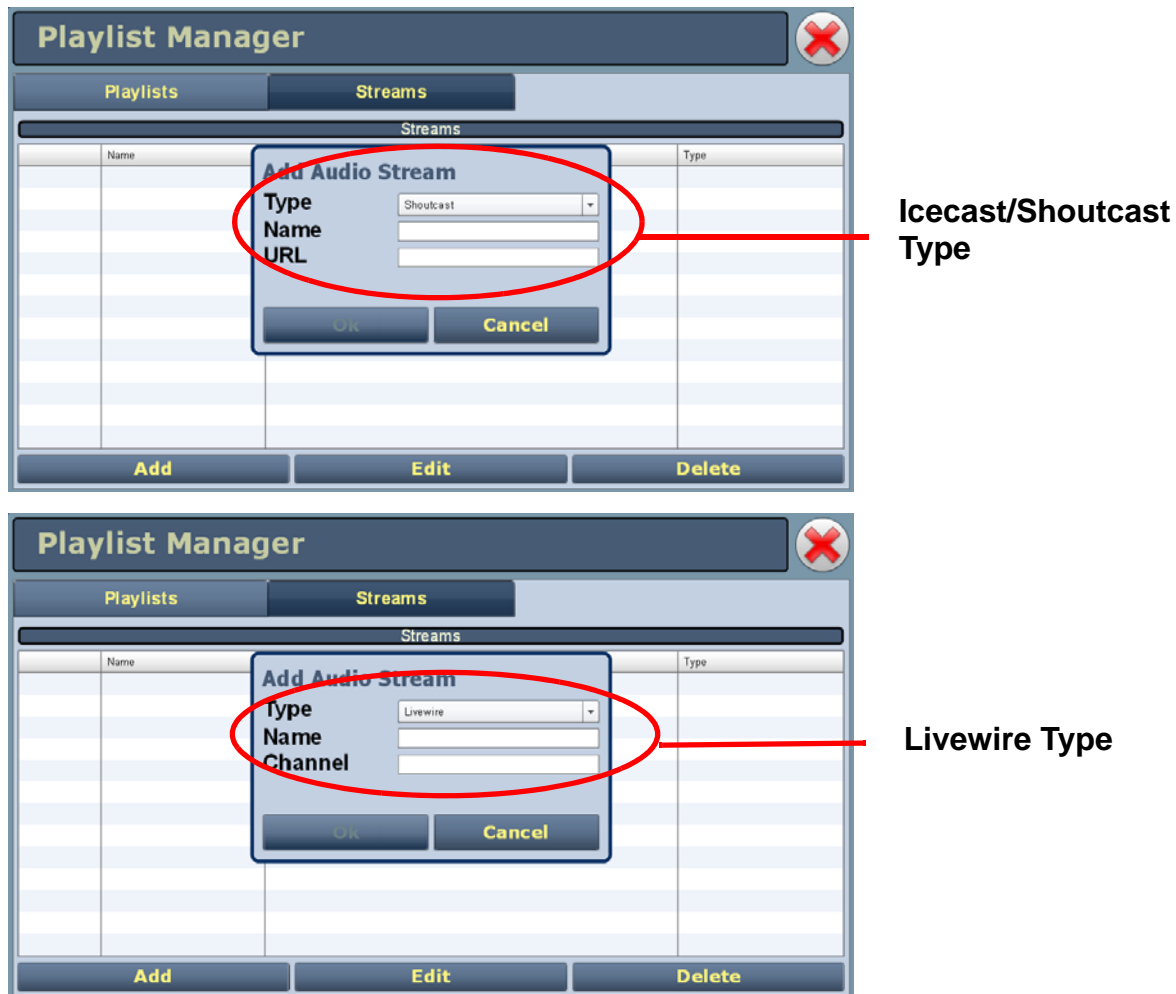

ADDING AN AUDIO STREAM

1. From the Streams tab (see [Figure 3.2.164](#) on page 3.2.191), press the Add button.
2. Use the drop-down menu to select the desired Type of audio stream - Icecast/Shoutcast or Livewire (see [Figure 3.2.167](#)).
3. Enter the appropriate information for the audio server (Name and URL for Icecast/Shoutcast; Name and Channel for Livewire). Make sure the GV5/GV3.5 can access the location.
4. Press OK to add the audio stream or press Cancel to discard changes.

EDITING OR DELETING AN AUDIO STREAM

1. From the Streams tab (see [Figure 3.2.164 on page 3.2.191](#)), select the desired audio stream from the list. Press the Edit button to modify the audio stream or the Delete button to remove the audio stream.
2. If you are editing an audio stream, enter the appropriate information for the audio server (Name and URL for Icecast/Shoutcast; Name and Channel for Livewire). Make sure the GV5/GV3.5 can access the location.
3. Press OK to either edit or delete the audio stream, or press Cancel to discard changes.

Enabling and Operating the Orban Audio Processor

This section describes how to configure, enable and operate the optional Orban audio processor after it is installed in your transmitter. You can interface with audio processor functionality using the transmitter's local (or remote) AUI or controller UI. The extent of the features available depends on which interface is used.

- [Configuring the Transmitter for the Orban Audio Processor - see page 3.2.197](#)
- [Enabling the Orban Audio Processor for Preset Selection - see page 3.2.199](#)
- [Selecting an Orban Audio Processor Preset - see page 3.2.202](#)

NOTE: Using the Orban Inside option requires the installation of an Orban audio processor card in your transmitter. If you had a pre-existing transmitter when you received your Orban Inside kit, verify that the Orban card has been installed in the transmitter according to the Orban Inside Quick Guide (QG12001), provided with the Orban Inside kit. Refer to the Pre-installation and Installation Manuals for information on purchasing and installing this option.

NOTE: This section contains frequent reference to Orban's Optimod-FM 5500 Digital Audio Processor Operating Manual (see the link below). The equipment covered in the 5500 manual uses the same Orban audio processor as in your transmitter. The 5500 manual provides detailed information on the audio processor's functionality. If a discrepancy exists between the operational instructions in the Orban manual and this document, the latter shall prevail as this document is specific to operation with an GV5/GV3.5 transmitter. View the Orban Optimod-FM 5500 Digital Audio Processor Operating Manual online at:

<ftp://ftp.orban.com/5500/Documentation/>

(the version number referenced in this link is controlled by a third party and is subject to change without notice)

Configuring the Transmitter for the Orban Audio Processor

Configure the GV5/GV3.5 to recognize the presence of the Orban card using the controller UI (see [Orban Enabling - using the Controller UI](#)) or the AUI (see [Orban Hardware Configuration - using the AUI - see page 3.2.198](#)) as follows:

NOTE: Configuring the Orban audio processor locally will cause the AUI to display an Orban Inside setting. The same occurs on the controller UI when configuring via the AUI.

Orban Hardware Configuration - using the Controller UI

1. With the transmitter turned on and in local mode of operation, navigate to the controller UI's Main Menu -> System Settings -> HW Config menu. Scroll down through this menu and select Audio Processor (see [Figure 3.2.168](#)).
2. In the Audio Processor screen(see [Figure 3.2.168](#)), use the up and down buttons to toggle between None and Orban Inside (default factory setting is None). Select Orban Inside to enable the Orban audio processor for use (selecting None disables it). Press the accept (checkmark) button to save the change. Press cancel (X) to discard changes and return to the previous menu.
3. Reboot the transmitter by switching the ac power off and then on. This will ensure the transmitter properly detects the Orban Inside card upon recovery.

Figure 3.2.168: Configuring the Transmitter - Controller UI HW Config and Audio Processor screens

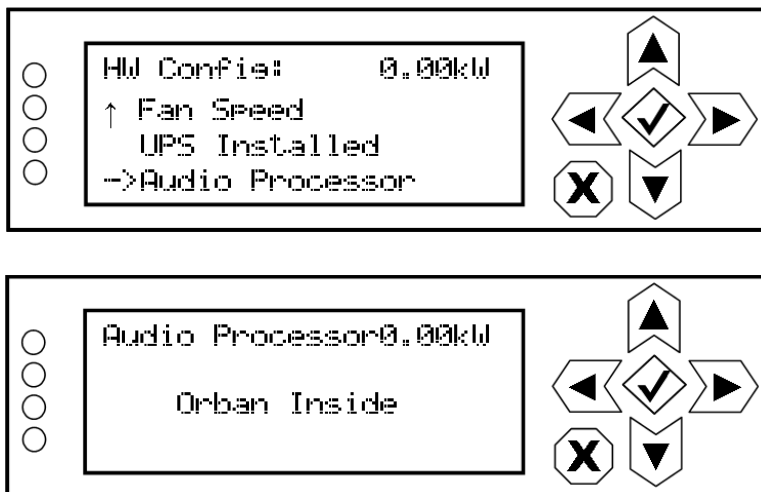

Orban Hardware Configuration - using the AUI

1. Navigate to the AUI's System Settings -> Hardware Configuration page (see [Figure 3.2.169](#)).
2. Press or click on the drop arrow in the Audio Processor field. Select Orban Inside to enable the Orban audio processor for use (selecting None disables it). Press or click the Apply button to save the change. Press or click Cancel to discard changes.
3. Reboot the AUI in the System Settings -> Reset page. This will ensure the transmitter properly detects the Orban Inside card upon recovery.

Figure 3.2.169: Configuring the Transmitter - AUI System Settings -> Hardware Configuration page

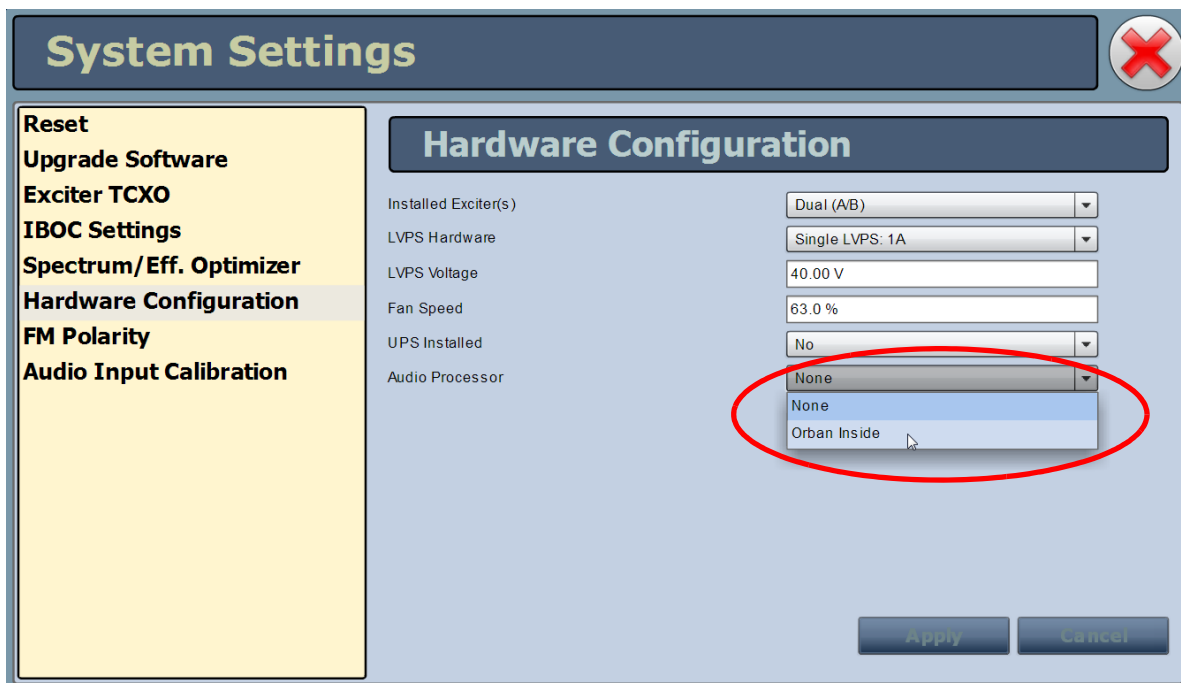

Enabling the Orban Audio Processor for Preset Selection

Enable the Orban audio processor to allow preset selection using either the controller UI (see [Orban Enabling - using the Controller UI](#)) or the AUI (see [Orban Enabling - using the AUI - see page 3.2.201](#)) as follows:

NOTE: Enabling the Orban audio processor locally will cause the AUI to display an enabled setting. The same occurs on the controller UI when enabling via the AUI.

Orban Enabling - using the Controller UI

1. With the transmitter turned on and in local mode of operation, navigate to the controller UI's Main Menu -> User Settings menu. Select Edit Presets (see A in [Figure 3.2.170 on page 3.2.200](#)).
2. In the Edit Presets screen (see B in [Figure 3.2.170 on page 3.2.200](#)), select from the list the desired preset for use with the Orban audio processor or create a new preset.
3. Within the selected preset's screen (see C in [Figure 3.2.170 on page 3.2.200](#)), scroll down and select Main Audio.
4. Within the Main Audio screen (see D in [Figure 3.2.170 on page 3.2.200](#)), scroll down and select Audio Processor. This option appears only when the transmitter has been configured for Orban Inside.
5. Within the Audio Processor screen (see E in [Figure 3.2.170 on page 3.2.200](#)), select Enable. From the Enable screen, select ON to enable the audio processor (selecting OFF disables the audio processor)

NOTE: The Orban Inside card processes only the main audio; however it is possible for the composite SCA inputs to result in excessive modulation. The L/R limiter is automatically disabled when the Orban Inside card is selected; however the other limiters (hard limiter, AGC limiter, 2-slope limiter) remain active. Nautel recommends that you set the thresholds for these other limiters high enough to ensure the signal is unaffected. These other limiters remain as a last resort to prevent over-modulation.

Figure 3.2.170: Enabling the Orban Audio Processor - Controller UI

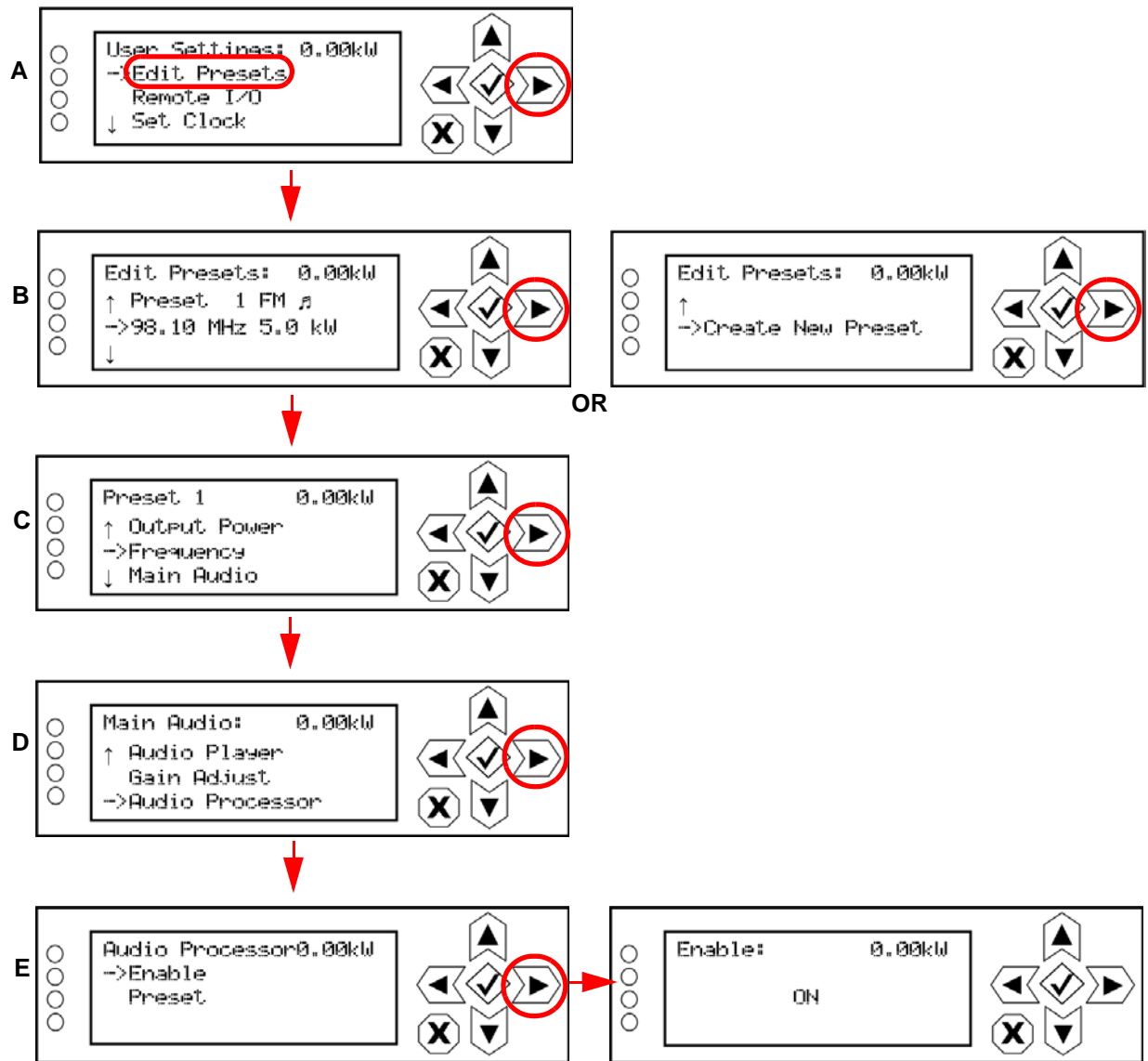

Orban Enabling - using the AUI

1. With the transmitter turned on, navigate to the AUI's Main Menu -> Presets page.
2. For the applicable preset, press the Other Settings tab (see [Figure 3.2.171](#)).
3. In the Orban Processor drop-down list, select Enabled to enable the audio processor (selecting Disabled disables the audio processor). Press Save to store the change.

Figure 3.2.171: Enabling the Orban Audio Processor - Remote AUI

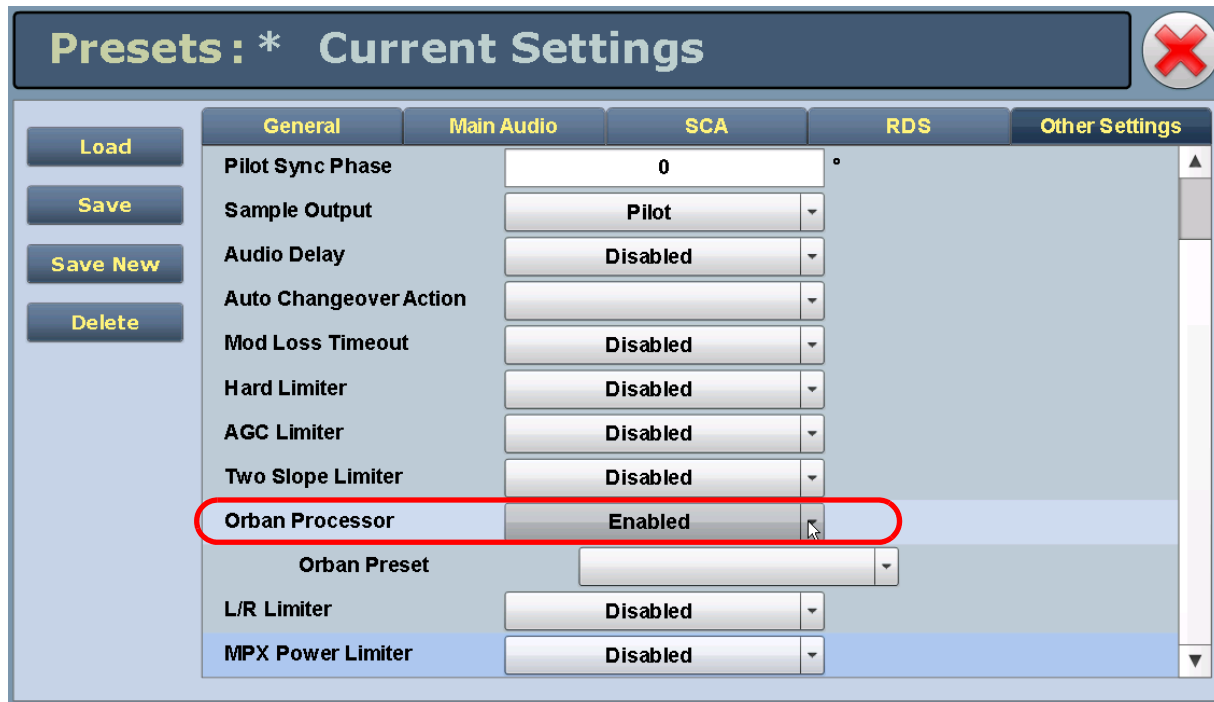

The screenshot displays the 'Presets: * Current Settings' window with a red 'X' close button in the top right corner. On the left side, there are four buttons: 'Load', 'Save', 'Save New', and 'Delete'. The main area is divided into five tabs: 'General', 'Main Audio', 'SCA', 'RDS', and 'Other Settings'. The 'Other Settings' tab is active. The settings are as follows:

Setting	Value
Pilot Sync Phase	0
Sample Output	Pilot
Audio Delay	Disabled
Auto Changeover Action	
Mod Loss Timeout	Disabled
Hard Limiter	Disabled
AGC Limiter	Disabled
Two Slope Limiter	Disabled
Orban Processor	Enabled
Orban Preset	
L/R Limiter	Disabled
MPX Power Limiter	Disabled

Selecting an Orban Audio Processor Preset

Select an Orban audio processor preset using either the AUI (see [Selecting an Orban Preset - using the AUI - see page 3.2.202](#)) or the controller UI (see [Selecting an Orban Preset - using the Controller UI](#)) as follows:

NOTE: Selecting an Orban preset via the AUI will cause the controller UI to also reflect the change, and vice versa. To create a new Orban Audio Processor Preset, see [Managing an Orban Audio Processor Preset, on page 3.2.204](#).

Selecting an Orban Preset - using the AUI

1. From the AUI's Main Menu -> Presets page, press the Other Settings tab (see [Figure 3.2.172](#)).
2. From the Orban Preset drop-down list, select the desired Orban preset (e.g., ROCK-LOUD, etc). Refer to the Orban Optimod 5500 manual for detailed information on the factory programmed presets available. Press Save to store the change. To create a new Orban preset, see [Managing an Orban Audio Processor Preset, on page 3.2.204](#).

Figure 3.2.172: Selecting an Orban Preset - Remote AUI

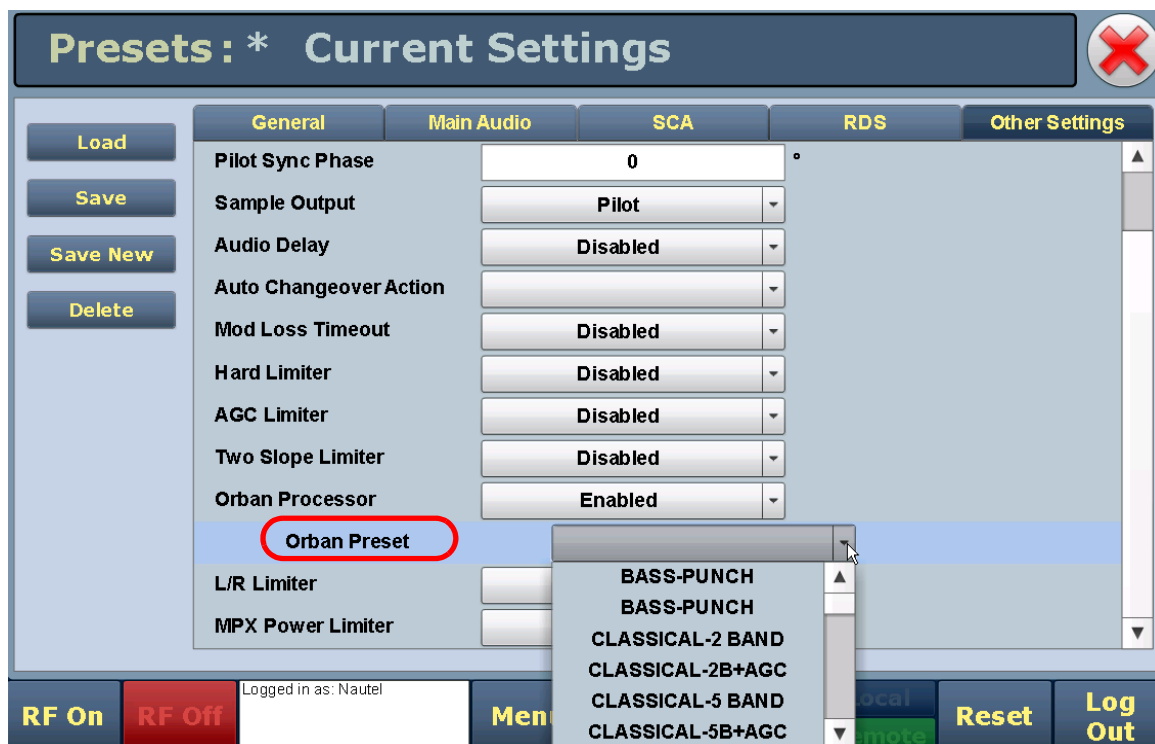

Selecting an Orban Preset - using the Controller UI

1. From the User Settings -> Edit Presets -> (Select desired preset to edit) -> Main Audio > Audio Processor menu (see [Figure 3.2.173](#)), select Preset.
2. Use the up and down arrows to scroll through the list of available Orban presets (e.g., ROCK-LOUD, etc). Select the desired preset and press the 'accept' (checkmark) button to activate. Refer to the Orban Optimod 5500 manual for detailed information on the factory programmed presets available.

Figure 3.2.173: Selecting an Orban Preset - Front Panel UI

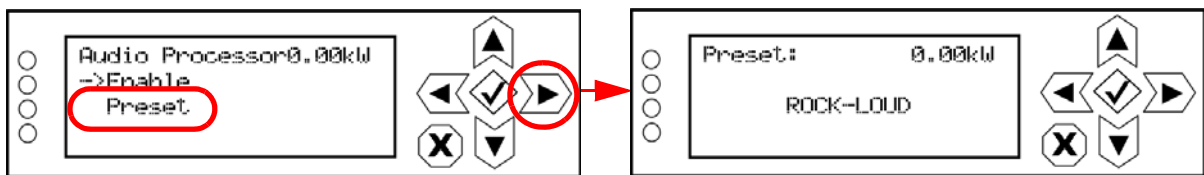

Managing an Orban Audio Processor Preset

Orban presets contain many audio processing settings, including stereo enhancement, AGC, EQ, final clipping and distortion. From the remote AUI (not available from the front panel UI), you can create Orban presets, manage their various settings and save the preset settings to a text file.

When the Orban Inside feature is enabled (see [Enabling the Orban Audio Processor for Preset Selection - see page 3.2.199](#)), an Audio Processor icon appears on the AUI's Main Menu window (see [Figure 3.2.174](#)). Press this icon to enter the Audio Processor menu (see [Figure 3.2.175 on page 3.2.205](#)).

WARNING! When you open the Audio Processor page while the transmitter is on and Orban is enabled, the active preset in the Orban audio processor is loaded by default. Loading another Orban preset causes that preset to become active. Make sure you understand the impact that a preset change will have on your broadcast.

NOTE: The Audio Processor page contains nine tabbed sections that allow managing of Orban presets. These tabbed pages (see [Figure 3.2.175 on page 3.2.205](#) and [Figure 3.2.177 on page 3.2.208](#) through [Figure 3.2.184 on page 3.2.211](#)) illustrate the many parameters associated with an Orban preset. Detailed descriptions are not included in this document. Refer to the Orban Optimod 5500 manual for more information on setting these parameters.

Figure 3.2.174: AUI Main Menu - with Audio Processor icon

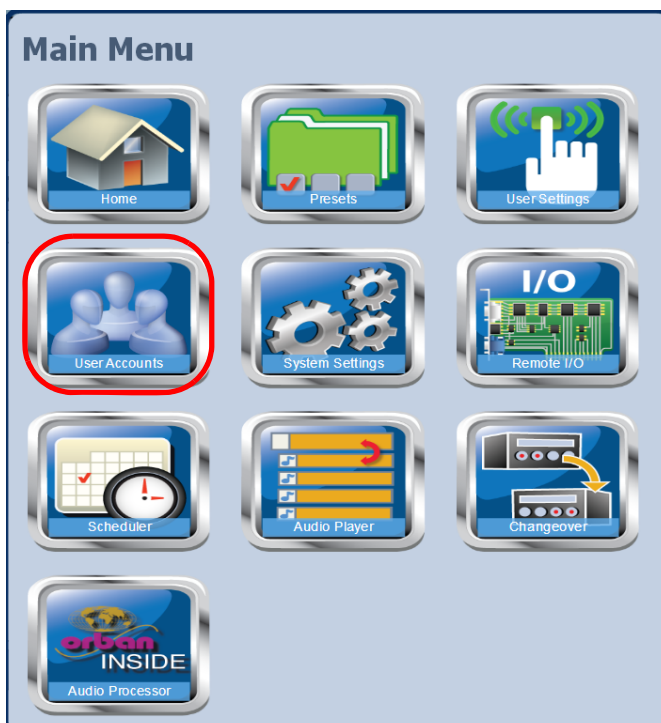

Figure 3.2.175: Audio Processor Menu - Less More tab shown

The screenshot displays the Nautel transmitter control interface. At the top, the 'Date & Time' section shows 'Thu May 24 2012' and '11:19:48'. The 'Transmitter Configuration' section shows '0 kW' power, 'FM' mode, '107.7 MHz' frequency, and '11.00 kW' set point. The 'Exciter' section shows 'Active Exciter A' and 'FM Modulation' at 9.02%. The 'Audio Processor' menu is open, with the 'Less More' tab selected. The 'Less More' tab shows a slider bar with a green section and adjustment buttons. Red arrows point to the slider bar (labeled 'Slider bar (green section)') and the adjustment buttons (labeled 'Adjustment Buttons'). A 'Current Setting' label points to the value 9.5 on the slider. The bottom status bar shows 'RF On', 'RF Off', 'Menu', 'Status', 'Logs', 'Local Remote', 'Reset', and 'Log Out'.

Loading and Saving Orban Presets

The left-hand side of the Audio Processor pages has four buttons (see below).



When you first enter the Audio Processor page, the current preset is displayed. If the current preset is not the preset you want to work with, press the Load button to call up a window containing a list of alternate presets. Presets that display an 'F' are factory presets that cannot be modified. Presets that display a 'U' are user presets that can be modified.

To activate any change in the Audio Processor page, press the Save button and then press the Save Preset window's Save As button [Save As and Delete buttons not available for factory (F) presets]. When creating a new preset, you can also enter a new name in the Save Preset window before pressing the Save As button. Press Cancel to discard changes and return to the Audio Processor page.

Pressing this button opens an Audio Processor meter window (see [Figure 3.2.176](#)) that displays various meters that indicate levels for inputs, AGC, gain reduction, multiplex (MPX) power and composite. Refer to the Operation section of the Orban Optimod 5500 manual for detailed information on these meters.

Pressing this button opens a window that allows downloading a text version of the preset to a folder on your PC or laptop.

Figure 3.2.176: Audio Processor meter window

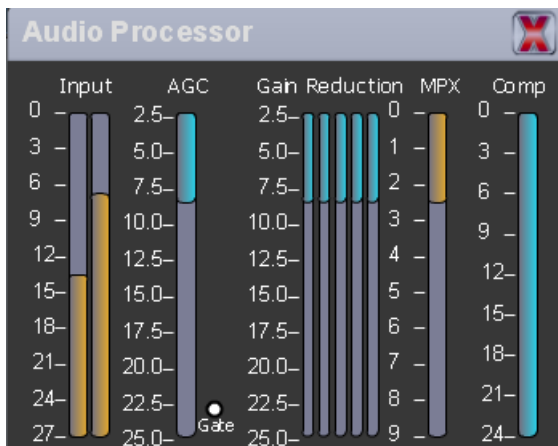

There are two types of Orban audio processor presets: factory presets and user presets. Factory presets, designated by an 'F' in the Load or Save screens, cannot be modified. When a factory preset control is changed, a new preset is automatically created. This preset's default name will be the same as the Orban preset with an asterisk (*) prefix (e.g., * EXTREME). Modified presets should be saved to a new name, otherwise they will be overwritten by any edits made to subsequent presets. A saved preset will display as a User preset, designated by a 'U' in the Load or Save screens. User presets can be modified.

Tab Sections

The following tabs (and referenced Figure numbers) are available on the Audio Processor page. Each provides specific control functions for the selected preset. Refer to the Orban Optimod 5500 manual for details on these settings.

- ❖ Less More - see [Figure 3.2.175 on page 3.2.205](#)
- ❖ Stereo Enhancer - see [Figure 3.2.177 on page 3.2.208](#)
- ❖ AGC - see [Figure 3.2.178 on page 3.2.208](#)
- ❖ EQ - see [Figure 3.2.179 on page 3.2.209](#)
- ❖ Final Clipping - see [Figure 3.2.180 on page 3.2.209](#)
- ❖ Multiband - see [Figure 3.2.181 on page 3.2.210](#)
- ❖ Compressors - see [Figure 3.2.182 on page 3.2.210](#)
- ❖ Bandmix - see [Figure 3.2.183 on page 3.2.211](#)
- ❖ Distortion - see [Figure 3.2.184 on page 3.2.211](#)

See [Figure 3.2.175 on page 3.2.205](#). Each control shows the current setting (in the middle of the control) and the available range of settings. You can make adjustments either by pressing the << or >> buttons or by moving (press, hold and move accordingly) the green slider bar, which indicates the setting graphically.

Figure 3.2.177: Audio Processor Menu - Stereo Enhancer tab

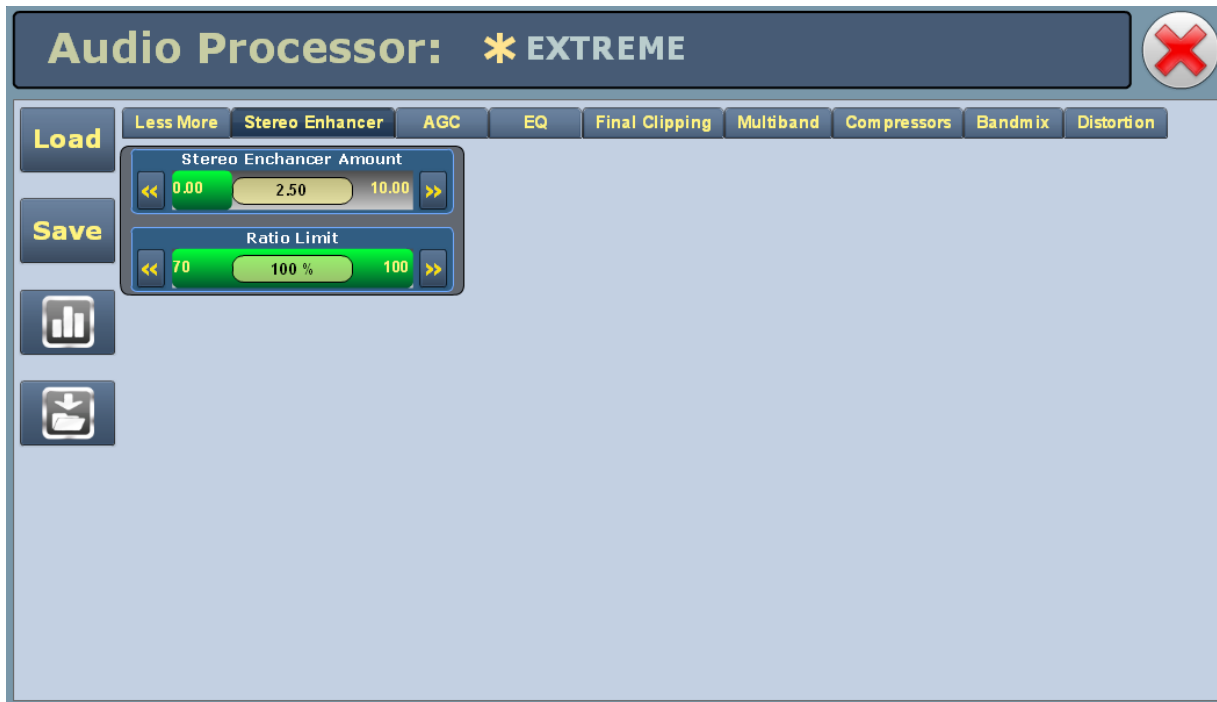

Figure 3.2.178: Audio Processor Menu - AGC tab



Figure 3.2.179: Audio Processor Menu - EQ tab



Figure 3.2.180: Audio Processor Menu - Final Clipping tab



Figure 3.2.181: Audio Processor Menu - Multiband tab



Figure 3.2.182: Audio Processor Menu - Compressors tab



Figure 3.2.183: Audio Processor Menu - Bandmix tab



Figure 3.2.184: Audio Processor Menu - Distortion tab



SECTION 3.3: ROUTINE MAINTENANCE

This section provides instructions for performing routine maintenance on the GV5/GV3.5 transmitter. This section includes the following topics:

- [Scheduled Maintenance](#)
 - ❖ [Cleaning](#)
 - ❖ [Checking Hardware - see page 3.3.2](#)
 - ❖ [Battery Replacement - see page 3.3.2](#)
- [Replacing an Air Filter - see page 3.3.3](#)
- [Performing On-Air Checks - see page 3.3.6](#)
- [Replacing the Controller Module's Battery - see page 3.3.7](#)
- [Inspecting Lightning Protection Systems - see page 3.3.9](#)

Scheduled Maintenance

Scheduled maintenance consists of performing a visual inspection of the GV5/GV3.5 at scheduled intervals. The recommended minimum time between scheduled maintenance visits is three months. Local operating and environmental conditions may dictate more frequent visits, while in remote sites less frequent visits may be acceptable. Experience and system reliability will determine the most practical schedule for a specific installation.

Cleaning

At a minimum, follow the cleaning procedures listed below.

NOTE: A site located in a dirty area using open-air cooling requires more extensive cleaning than a site located in a clean area using closed-air cooling.

1. Check the air filters, noting there is one in the front door of the transmitter and one in the back of the transmitter. Remove each air filter, inspect it, then re-install the air filter if it is clean. If an air filter is dirty or damaged, replace it as soon as possible. See ["Replacing an Air Filter" on page 3.3.3](#).
2. Clean the GV5/GV3.5 using a vacuum cleaner and a soft-bristle brush to remove loose dirt. Clean, damp rags should be used to remove dirt that cannot be removed with a vacuum cleaner. Never use compressed air to clean the GV5/GV3.5.

Checking Hardware

All hardware must be checked at least once a year. Thermal cycling from turning the GV5/GV3.5 on and off will require more frequent checks.

- To prevent damaging the hardware, ensure that the proper sized tools are used. In most cases, hardware is metric.
- A mounting surface or terminal that has changed colour indicates a loose hardware connection.
- Check and, if necessary, retorque the ac input cables on terminal block TB1. See [Section 2.5, "Connecting Ac Power" on page 2.5.1](#) of the GV5/GV3.5 Installation Manual to determine specific torque values.

Battery Replacement

The controller assembly contains a battery backup circuit that provides a memory of the transmitter time setting during ac power failure. See ["Replacing the Controller Module's Battery" on page 3.3.7](#).

Replacing an Air Filter

The transmitter contains one cotton air filters in the front door of the transmitter and one in the upper, rear panel of the transmitter. If an air filter becomes dirty or damaged, replace it as follows:

Interval

As required.

Parts and tools

- Replacement air filter

Procedure

Take the following steps to replace an GV5/GV3.5 air filter:

1. Order a new filter or filters, as necessary. You can order a standard sized filter from Nautel (Nautel Part # HR142) or from the manufacturer (18" x 24" x 2", American Air Filter PerfectPleat SC M8 MERV 8 or equivalent) or obtain one from any local supplier of HVAC supplies.
2. Unpack the new filter and inspect it for damage.
3. Remove the old or damaged filter as follows:
 - ❖ For a front air filter (see [Figure 3.3.1 on page 3.3.4](#)), open the front door. On the back side of the door, loosen the two quarter-turn fasteners securing the filter bracket to the door. Lift out the filter bracket. Remove (slide out) the air filter from the door.
 - ❖ For a rear panel filter (see [Figure 3.3.2 on page 3.3.5](#)), loosen only the four quarter-turn fasteners securing the filter bracket to the panel (removal of the entire rear panel is not necessary). Remove the filter bracket. Remove (slide out) the air filter from the panel.
4. Insert the new air filter into the bracket, noting the air flow direction in [Figure 3.3.1 on page 3.3.4](#) or [Figure 3.3.2 on page 3.3.5](#). Reinstall the filter bracket on the front door or rear panel, as applicable. Tighten the quarter-turn fasteners to secure the filter bracket to the front door (two fasteners) or rear panel (four fasteners).
5. Dispose of the dirty or damaged air filter.

Figure 3.3.1: Replacing Front Air Filters

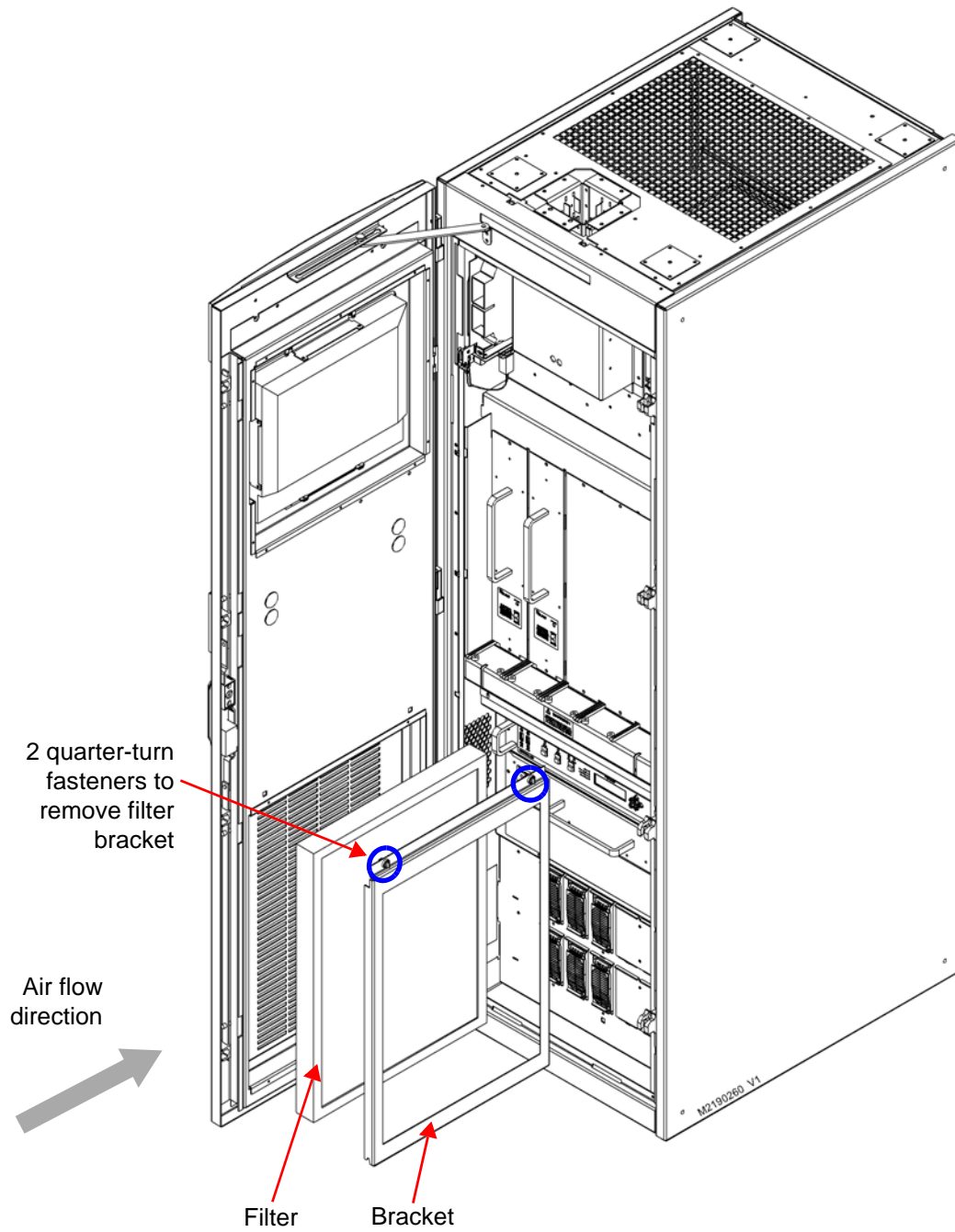
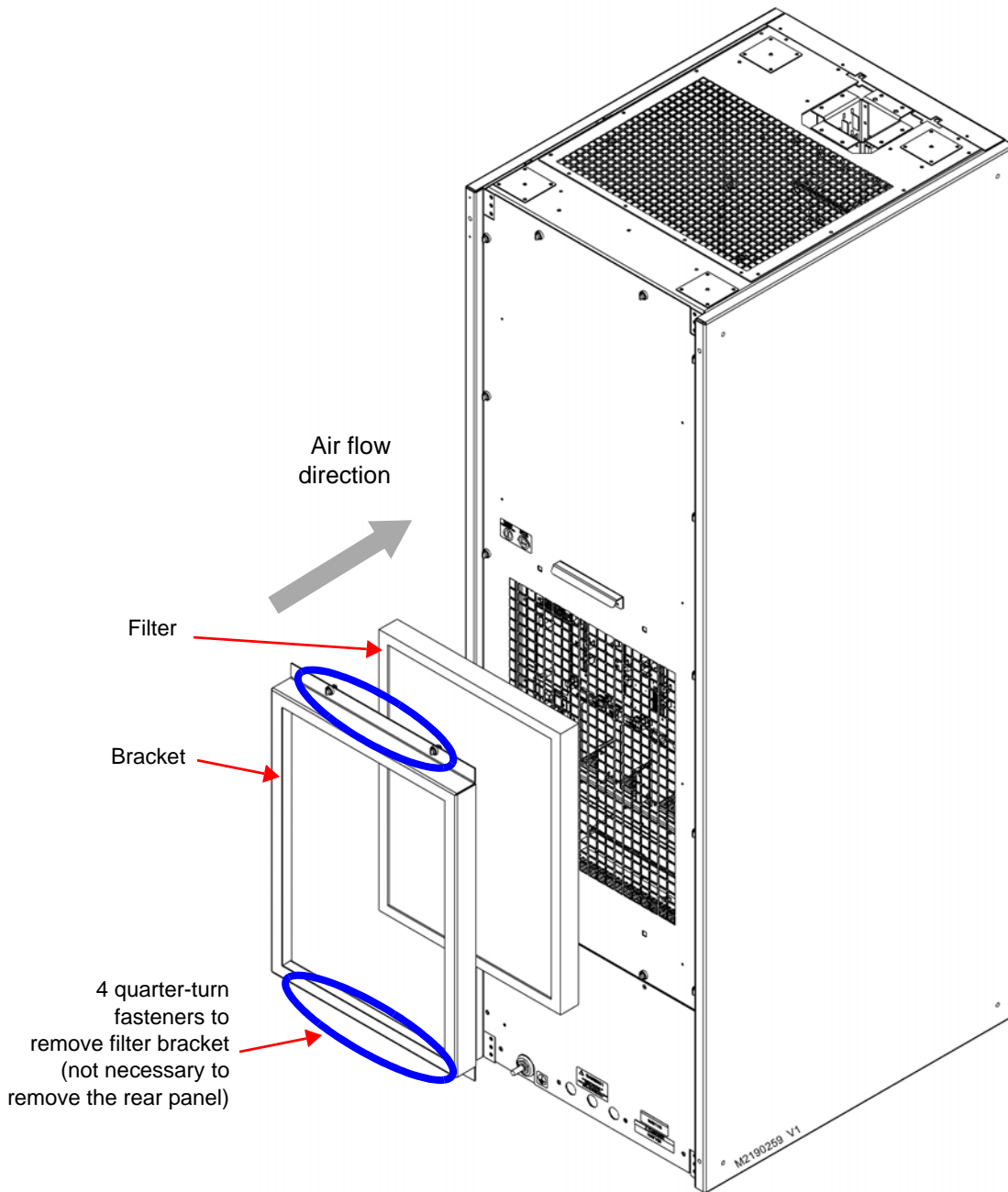

Figure 3.3.2: Replacing Rear Air Filters



Performing On-Air Checks

You should check the on-air quality of the transmitter's signal periodically. This check can be done locally at the transmitter site, or remotely from another location in the transmitter's coverage area.

Interval

Every 12 months, or as required by law.

Parts and Tools

- High-quality receiver compatible with the modulation scheme used on the transmitter.

Procedure

1. Monitor the transmitter signal to identify any problems:
 - ❖ Use a high quality receiver to monitor audio quality.
 - ❖ Check the spectral output of the transmitter. You can use the local or remote AUI's spectrum analyzer to accurately assess the transmitter's spectral output.
 - ❖ Take a portable receiver to different locations in your coverage areas to identify any problems with the antenna pattern or areas of localized interference.
2. Obtain the Critical Parameters sheet that was completed during factory testing and provided with the transmitter. Use the transmitter's AUI to compare current transmitter settings with those on the Critical Parameters sheet.

NOTE: Nautel completes the Critical Parameters sheet with the transmitter terminated into a precision 50 ohm load. Measurements made on site into a dummy load or station antenna may not yield the same readings. Slight variances are acceptable. The data is provided as a troubleshooting aid.

Replacing the Controller Module's Battery

Replace the battery on the controller module's controller PWB (A4A2) once a year, or whenever the Controller - Low Battery alarm appears (on the AUI, controller UI or via remote digital output). Chemical leakage from an old battery can cause damage.

Interval

Every 12 months.

Parts and Tools

Replacement battery: 3 V lithium coin cell, 20 mm (Nautel Part # BBLT01, Panasonic # CR2032).

Procedure

Perform the following steps to replace the battery:

1. Remove the upper, rear filter panel by loosening the 12 quarter-turn fasteners securing the panel to the transmitter.
2. Replace the battery in the 3V BATTERY holder on the rear of the controller assembly (see [Figure 3.3.3 on page 3.3.8](#)).
3. Re-install the upper, rear filter panel removed in [Step 1](#).
4. Check for any alarms on the AUI (local or remote) or controller UI (see "[Viewing Transmitter Status - using the AUI](#)" on [page 3.2.97](#)). Battery related alarms should clear.
5. Reset the system clock via the AUI (local or remote) or controller UI (see "[Setting the Clock](#)" on [page 3.2.151](#)).

NOTE: If the NTP server feature has been enabled, your clock setting will automatically reset within approximately five minutes. See "[Configuring NTP Servers](#)" on [page 3.2.154](#) for more information.

Figure 3.3.3: Replacing Controller Battery

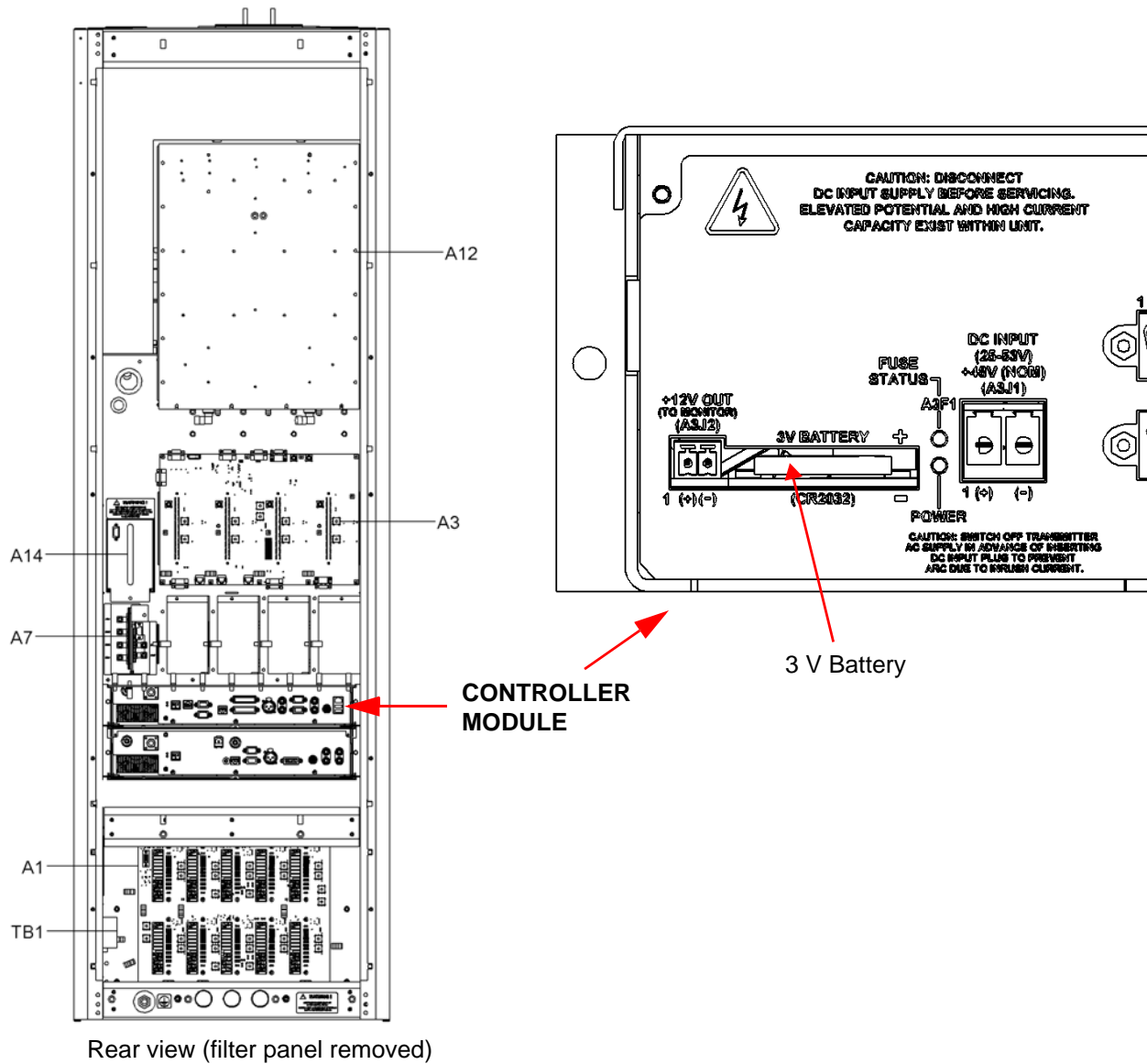

Inspecting Lightning Protection Systems

You should inspect the lightning protection systems that are connected to your GV5/GV3.5 transmitter, ac power, RF feedline, antenna and tower periodically to ensure that your site, equipment and personnel are fully protected.

Interval

Every 6 months.

Parts and Tools

Depends on your site, but may include a digital multimeter, ladder, binoculars, and continuity tester.

Procedure

Perform the following steps to test the lightning protection systems:

1. Test the continuity between ground available at your lightning arrestor and ground available on various pieces of equipment connected to the transmitter. Ensure that there is no resistance (near 0 ohms, accounting for multimeter test lead resistance).
2. Physically inspect the lightning arrestor to ensure that all connections are tight. Also look for any sign of scoring or burning (indications of possible damage from earlier lightning strikes).
3. Using binoculars, visually inspect the hardware on the tower. Look for charred, broken or frayed connections and corrosion.

SECTION 3.4: NON-STANDARD MAINTENANCE

This section provides instructions for performing non-standard maintenance on the GV5/GV3.5 transmitter. This section includes the following topics:

- [Upgrading Software](#)
- [Configuring a Mod Loss Backup Preset - see page 3.4.4](#)

Upgrading Software

Periodically, enhancements or improvements to the operating system are identified and made available. Perform a software upgrade, as required, as follows:

NOTE: Nautel recommends you perform a software upgrade at the transmitter site.

Parts and Tools

- Laptop (i.e., local computer for direct connection) or network computer with Windows and Internet Explorer Web browser
- CAT5 Ethernet cable
- Upgrade software (*.tgz file), provided via email or web download

Preliminary Checks

1. Determine the current software revision installed. Via the advanced user interface (AUI) screen, go to Menu/System Settings/Upgrade Software. Select the *.tgz file in the Select Upgrade File list (should highlight in blue) and click Details. Note the current software revision for Audio Player, AUI, Axia Livewire Module, Controller, Exciter B (if applicable), Orban Inside (if applicable), Rack, Server, SNMP Agent and Watchdog.
2. Contact Nautel for the most recent software revision and download *.tgz file to a laptop or network location.
3. Maximize the ARM's disk space by deleting the old .tgz files. Use the Manage Files button to display the Upload Files window, select the file(s) to delete, and click the Delete button

Transferring Upgrade File

The following steps assume either the laptop will be used to connect directly to the transmitter OR the transmitter and network computer are currently connected to the same network.

Transmitter IP Configuration

1. From the transmitter AUI, go to Menu/User Settings/Network Setup.
2. Record your current network settings (IP Address, Subnet Mask, Default Gateway).
3. If connecting to the transmitter directly with a laptop, you must set a static IP address. This can only be done via the front panel interface. From the front panel UI's Main Menu, go to User Settings/Network Settings and set the IP address as follows:
 - DHCP: OFF
 - IP Address: 10.10.10.2
 - Netmask: 255.255.255.0
4. Set the transmitter for Remote control.

Laptop IP Setup

The following steps assume the operating system is Windows XP. Adapt as required for computers with different operating systems.

1. On the laptop go to Start Menu/Control Panel/Network Connections/Local Area Network.
2. In the Local Area Network Status, open the General tab and choose Properties. Scroll down and highlight Internet Protocol (TCP/IP). Choose Properties.
3. In the Internet Protocol (TCP/IP) Properties window, select Use the following IP address.
4. Enter the following settings:
 - IP Address: 10.10.10.1
 - Subnet Mask: 255.255.255.0
 - Default Gateway: 192.168.1.2
5. In the Internet Protocol (TCP/IP) Properties window, select OK.
6. In the Local Area Connection Properties window, select OK.
7. In the Local Area Connection Status window, select Close.
8. Close the Network Connections window.

Transfer Software Upgrade File to Transmitter

1. If using a laptop, connect the laptop network interface card to the transmitter LAN (A1J8A) connector on the rear panel using a CAT5 Ethernet cable. Open Internet Explorer and search for 10.10.10.2. The transmitter login screen should appear.
2. If using a network computer, open Internet Explorer and search for the IP address recorded in [Step 2 of Transmitter IP Configuration, on page 3.4.2](#). The transmitter login screen should appear.
3. At the transmitter login screen enter:
 - User: "Nautel" or "****", where **** is the user assigned user name
 - Password: leave blank (default) or "****", where **** is the user assigned password
4. Navigate through the AUI to Menu/Software/Upload Files, select the upgrade files tab and press Browse. Locate the software update *.tgz file stored on the laptop or network computer, and press Upload to load the file into the transmitter upload file list. Allow this operation to complete.

Installing New Software

1. Set the transmitter to RF Off and for Remote control. If the transmitter is already in Remote control mode, turn off the transmitter using the AUI on the laptop. Perform the following steps remotely using the AUI on the laptop.
2. Go to the AUI Menu/System Settings/Upgrade Software screen and select the update *.tgz file from the Select Upgrade File list (should highlight in blue) and press Start Upgrade.

CAUTION! Do not leave this page until the flash process is complete.

3. After a successful load (status is 100% complete and a message indicates a successful load), cycle the ac power (turn off, then on) on the GV5/GV3.5.
4. This completes the software upgrade. Restore the former network settings on the transmitter and laptop as required (see [Step 2 of Transmitter IP Configuration, on page 3.4.2](#)).
5. Login and repeat [Step 1 of Preliminary Checks, on page 3.4.1](#) to determine if the current version is the same as the upgrade version - this confirms the upgrade was successful.
6. If the upgrade was not successful, repeat [Step 1](#) through [Step 5](#). If still unsuccessful, contact Nautel.

Configuring a Mod Loss Backup Preset

The GV5/GV3.5 contains an audio level detection circuit that can be used, when enabled, to allow switching to a secondary (backup) audio input source upon the loss of the primary source. Configure the desired transmitter preset to perform this function as follows (refer also to Section 2 of this manual for operating instructions of the AUI (local or remote) and controller UI (local) interfaces):

NOTE: You must configure a minimum of two presets to allow this feature to operate. One preset will act as the primary, or normal operating preset. The second preset will act as the secondary, or backup audio preset. Configure the backup audio preset first.

Configuring the Backup Audio Preset

1. From the transmitter AUI, go to Menu/Presets/Load. The Load Preset window in [Figure 3.4.1](#) shall display.
2. Select a suitable preset to use as a template to create a new backup audio preset. Click Load.

Figure 3.4.1: Load the Backup Preset Template

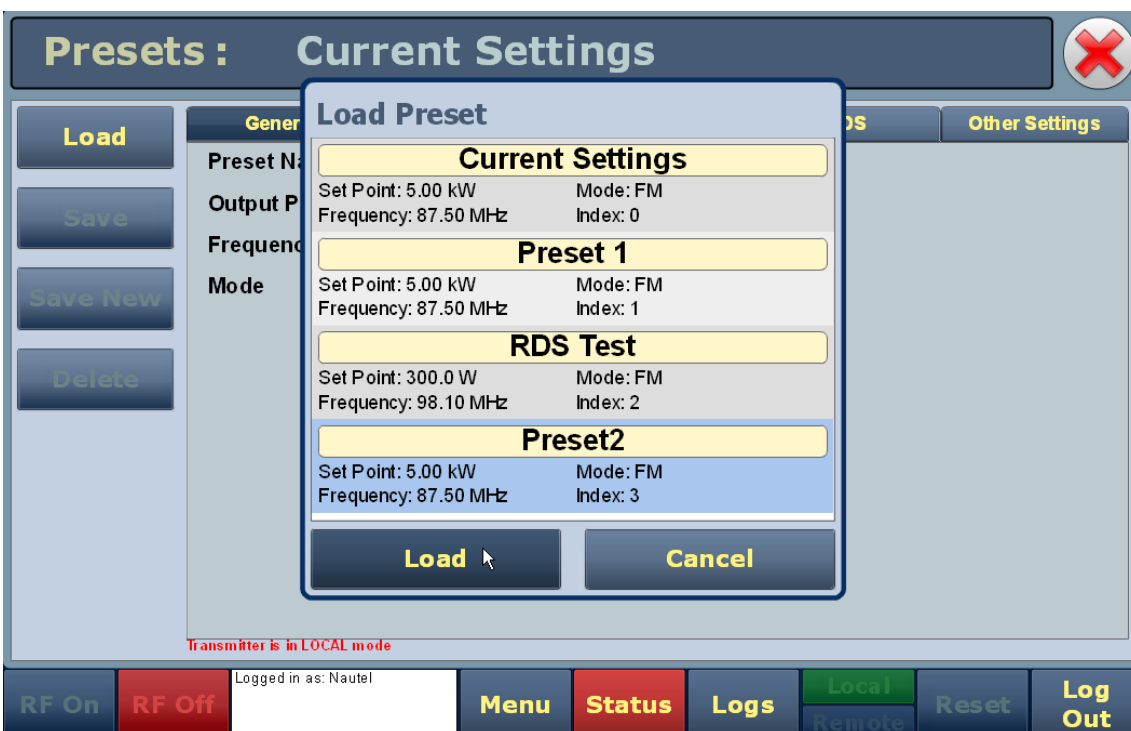
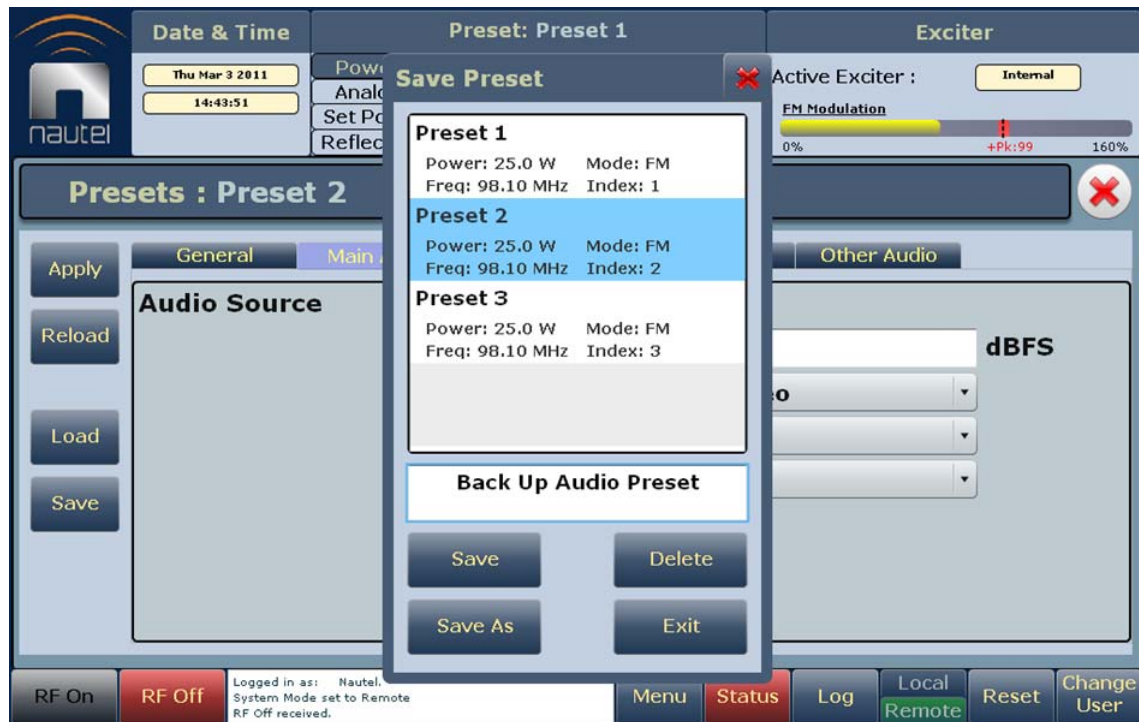

Figure 3.4.2: Backup Preset Main Audio Screen



3. The setup page for the selected preset should now appear. Click the Main Audio tab (see [Figure 3.4.2](#)).
4. Click the Audio Source field's drop-down arrow to view the available audio sources. Select the desired backup audio source.
5. Configure the other fields associated with your Audio Source selection.
6. To save your changes without affecting the original template preset's settings, create a new preset as follows (see also [Figure 3.4.3](#) on page 3.4.6):
 - ❖ Click the Save button on the left side of the AUI display. The Save Preset window will appear.
 - ❖ The template preset's name appears just below the list of presets. Click in the name field and enter the new name of the backup preset being created (e.g., Backup Audio Preset).
 - ❖ Do not click Save. It will overwrite or rename the original template preset.
 - ❖ After naming the new backup audio preset, click the Save As button.
 - ❖ This will save the preset as a new preset and not effect the original template preset. This completes configuration of the Backup Audio preset. Return to the home AUI panel.

Figure 3.4.3: Saving the Backup Preset



Configuring the Primary Audio Preset

1. Go to Menu/Presets/Load. The Load Preset window in [Figure 3.4.1](#) shall display.
2. Select your primary or normal preset to allow editing of its audio loss parameters. Click Load.
3. The setup page for the selected preset should appear. Click the Other Settings tab (see [Figure 3.4.4 on page 3.4.7](#)).
4. Open the Mod Loss Timeout field's drop-down menu. Select Yes. This will display five sub-fields - Action, Mod Loss Preset, Timeout Minutes, Timeout Seconds and Threshold.
 - ❖ Open the Action field's drop-down menu. Select Change Preset.
 - ❖ Open the Mod Loss Preset field's drop-down menu. Select the newly created backup audio preset.
 - ❖ Enter in the Timeout Minutes and/or Timeout Seconds fields the desired delay between the loss of audio and the action to change to the backup preset.
 - ❖ Enter in the Threshold field the desired percentage level of audio at which the timeout period begins. Typically, this is set to 10%.

Figure 3.4.4: Normal Preset - Other Settings screen

General	Main Audio	SCA	RDS	Other Settings
Pilot Level		9.0	%	
Pilot 1PPS Sync		Enabled		
Pilot Sync Phase		0	°	
Sample Output		Pilot		
Audio Delay		Enabled		
Audio Delay		0.000	ms	
Auto Changeover Action				
Mod Loss Timeout		Enabled		
Action		None		
Timeout Minutes		0	min	
Timeout Seconds		5.0	sec	
Threshold		0	%	

NOTE: SCA, RDS and Pilot modulation levels are additive and contribute the audio level. If their combined levels exceed the audio loss threshold level, a preset change will not occur. Stations with audio content containing extended nulls or silent periods (e.g., classical music) should consider reducing the audio loss threshold or increasing the timeout period.

- After configuring the modulation loss parameters, click the Save button. The Save Preset window will appear.
- Select the preset within the Save Preset window and click Save. This completes configuration of the Primary Audio preset. Return to the home GUI panel.

SECTION 3.5: LIST OF TERMS

This section defines some of the terms that are used in Nautel documentation.

AES/EBU. Audio Engineering Society/European Broadcasting Union (AES/EBU) is the name of a digital audio transfer standard. The AES/EBU digital interface is usually implemented using 3-pin XLR connectors (the same type connector used in professional micros). One cable carries both left-channel and right-channel audio data to the receiving device.

AUI. The Advanced User Interface is the local touch screen on the front door and the advanced remote control/monitoring feature that allows for extensive remote control and monitoring of the transmitter.

CUTBACK. A reduction in RF output power, caused by the occurrence of multiple shutbacks within a pre-defined period.

DHCP. Dynamic Host Carrier Protocol.

DSP. Digital Signal Processing.

EEPROM. Electrically Erasable Programmable Read-Only Memory.

FOLDBACK. A reduction in RF output power, caused by adverse load conditions (high VSWR). No shutbacks or cutbacks have occurred.

LED. Light Emitting Diode (also referred to as lamp).

LVPS. Low Voltage Power Supply. A module or modules used in the ac-dc power stage that generates the low level dc supply voltage for the transmitter.

PRESET. A setting that controls power level, frequency and audio parameters. The GV5/GV3.5 allows you to pre-program multiple presets.

PWB. Printed Wiring Board.

SHUTBACK. A complete, but temporary loss of RF output power, caused by any one of a variety of faults, including high VSWR, high reject load power, RF drive failure, or an open external interlock.

SHUTDOWN. A complete and permanent loss of RF output power. Typically follows repeated cutback, foldback or shutback events.

SURGE PROTECTION PANEL. An electrical panel that protects equipment from electrical surges in the ac power supply, antenna or site ground caused by lightning strikes.

UI. The User Interface is the controller module's front panel LCD screen that allows for extensive local control and monitoring of the transmitter.

VSWR. Voltage standing wave ratio. This is an expression of the ratio of reverse voltage to forward voltage on the feedline and antenna system. An ideal VSWR of 1:1 provides maximum transmitter-antenna efficiency.

GV5/GV3.5 OPERATIONS & MAINTENANCE MANUAL

Document: NHB-GV3.5-GV5-OPS

Issue: 2014-07-23

Nautel Limited

10089 Peggy's Cove Road
Hackett's Cove, NS Canada B3Z 3J4

Toll Free: +1.877.6NAUTEL (662.8835)
(Canada & USA only) or

Phone: +1.902.823.3900 or

Fax: +1.902.823.3183

Nautel Inc.

201 Target Industrial Circle
Bangor, Maine USA 04401

Phone: +1.207.947.8200

Fax: +1.207.947.3693

Customer Service (24-hour support)

+1.877.628.8353 (Canada & USA only)

+1.902.823.5100 (International)

Email: support@nautel.com

Web: www.nautel.com

© Copyright 2013 NAUTEL. All rights reserved.

