



**3: OPERATIONS & MAINTENANCE
MANUAL**

**GV2-10/GV2-7.5
TRANSMITTER**

Document ID:	NHB-GV7.5-GV10-OPS
Version:	6.0
Issue Date:	2024-05-01
Status:	Standard

making digital broadcasting work



Contact Information

Nautel Limited

10089 Peggy's Cove Road
Hackett's Cove, NS Canada B3Z 3J4

Toll Free: +1.877.6NAUTEL (662.8835)
(Canada & USA only) or

Phone: +1.902.823.3900 or

Fax: +1.902.823.3183

Nautel Inc.

201 Target Industrial Circle
Bangor, Maine USA 04401

Phone: +1.207.947.8200

Fax: +1.207.947.3693

Customer Service (24-hour support)

+1.877.628.8353 (Canada & USA only)

+1.902.823.5100 (International)

Email: support@nautel.com

Web: www.nautel.com

The comparisons and other information provided in this document have been prepared in good faith based on publicly available information. For verification of materials, the reader is encouraged to consult the respective manufacturer's most recent publication on the official website or through contact with Customer Service.

© Copyright 2024 NAUTEL. All rights reserved.

CONTENTS

Contact Information	3.iii
<hr/>	
RELEASE CONTROL RECORD	3.vii
<hr/>	
DESCRIPTION	3.1.1
GV2-10/GV2-7.5 Electrical Schematics	3.1.1
Control/Monitor Stage	3.1.3
RF Drive Stage	3.1.4
RF Power Stage	3.1.5
<hr/>	
OPERATING THE TRANSMITTER	3.2.1
User Interface Options	3.2.4
Advanced User Interface (AUI)	3.2.9
Managing and Displaying Dashboard Panels	3.2.20
AUI Main Menu	3.2.35
Controller Front Panel UI (User Interface)	3.2.118
Select Preset	3.2.126
User Settings	3.2.127
View Status	3.2.164
Reset Alarms	3.2.168
Exciter Changeover Settings	3.2.169
System Settings	3.2.171
Remote I/O Settings	3.2.190
Orban Audio Processor	3.2.194

ROUTINE MAINTENANCE	3.3.1
Scheduled Maintenance	3.3.1
Replacing an Air Filter	3.3.3
Performing On-Air Checks	3.3.6
Replacing the Controller Module’s Battery	3.3.7
Inspecting Lightning Protection Systems	3.3.9
NON-STANDARD MAINTENANCE	3.4.1
Upgrading Software	3.4.1
Software Upgrade via Remote AUI	3.4.2
Screen Configuration	3.4.8
Changing the OS Password	3.4.10
Configuring a Mod Loss Backup Preset	3.4.11
LIST OF TERMS	3.5.1

RELEASE CONTROL RECORD

ISSUE	DATE	REASON
6.0	2024-05-01	Release 6 of GV2-10/GV2-7.5 (NARF72F/02). Supports software version GV2 SW 1.0.0 and later.

SECTION 3.1: DESCRIPTION

This section provides a high-level description of the transmitter's key sections. The transmitter circuitry is subdivided into four basic stages:

- Ac-Dc Power Stage
- Control/Monitor Stage - see page 3.1.3
- RF Drive Stage - see page 3.1.4
- RF Power Stage - see page 3.1.5

Refer to the functional block diagram, [Figure 3.1.1 on page 3.1.9](#).

GV2-10/GV2-7.5 Electrical Schematics

Some descriptions in this section refer to electrical schematics (SD-#s). These are located in Section 4 of the GV2-10/GV2-7.5 Troubleshooting Manual.

Ac-Dc Power Stage

See electrical schematic Figure SD-1. The ac-dc power stage provides power to operate the low voltage power supplies, which generate the 40 to 48 V dc voltage that is converted to the low level dc voltages (± 15 V and +5 V) used throughout the transmitter. This voltage is also conditioned to operate cooling fans in the RF power module and reject load assemblies. The ac-dc power stage also converts the ac power source to a positive dc voltage (PA volts) for the transmitter's RF power amplifiers and exciter(s). The transmitter accepts a wide range of ac input voltage options:

- ❖ 3-phase, 180 - 264 V ac (208 V ac nominal)
- ❖ 3-phase, 312 - 457 V ac (380 V ac nominal)
- ❖ 1-phase, 180 - 264 V ac (240 V ac nominal)

The ac-dc power stage comprises ac input terminal block TB1, power supply interface PWB (A1), low voltage power supply (LVPS) modules A (U2), B (U3), and power supply modules (U4 through U11), two for each of the four RF power modules. There are three amber LED pilot lamps (DS1 through DS3), located in the bottom, rear of the cabinet, that indicate the presence of each ac phase.

Power Supply Interface PWB

See electrical schematic Figure SD-1. The power supply (PS) interface PWB (A1):

- ❖ interfaces between the ac input on terminal block TB1 and the LVPS and power supply modules.
- ❖ distributes LVPS voltage to the RF drive (exciter) stage and the control/monitor stage.
- ❖ distributes PA voltage to the RF power stage and the control/monitor stage.
- ❖ controls, with the controller module, the LVPS output voltage.
- ❖ provides RS485 serial communication between the module control/interface PWB and the RF power module power supplies.
- ❖ allows configuration of the LVPS modules if the UPS option is installed.
- ❖ provides status and alarm outputs from the LVPS and power supply modules, consisting of Module Present, Power Fail Warning, Rectifier Fault and Overtemp Warning (provided to the module control/interface PWB over a serial bus).

LVPS Modules

See electrical schematic Figure SD-1. LVPS modules A (U2) and B (U3) convert the ac input voltage to the regulated output (40 - 48 V dc, nominally 40 V) that is applied to, and controlled by, the controller module via the module control/interface PWB. +5 V, +15 V and -15 V regulated outputs are developed from the LVPS output voltage (40 - 48 V dc) on the module control/interface PWB.

Power Supply Modules

See electrical schematic Figure SD-1. Power supply modules U4 through U11 convert the ac input voltage to a regulated dc supply (PA volts) for all four RF power modules. Each switching power supply module is rated for a nominal 2725 W and provides an output voltage between 18 V and 53 V (typically 40 V). The modules regulate the output voltage based on a serial control input from the controller module (A4), applied via the module control/interface PWB. Each module has a built-in cooling fan, senses excessive temperature conditions and applies an Overtemp Warning signal (for indication purposes only) to the module control/interface PWB. The module also senses out-of-regulation on the ac input and dc output, and applies a Power Fail Warning signal to the module control/interface PWB. Both conditions cause the power supply to shut itself down, thus reducing the transmitter's RF output. All power supply module signals are applied to the controller for system level monitoring.

Control/Monitor Stage

See electrical schematic Figure SD-2. The control/monitor stage performs many critical functions for the transmitter. It:

- ❖ contains monitoring and protection circuits to prevent transmitter damage under adverse or fault conditions, including high speed SWR protection and interlock/muting.
- ❖ monitors the current value of various parameters including cooling fan tachometer outputs, transmitter output forward and reflected power, module temperature, PA current levels, and PA power supply status signals.
- ❖ measures and monitors the output voltage from the power supply modules as well as the low voltage power supplies.
- ❖ generates the signals that enable the power supply modules and control their output voltage.
- ❖ provides the status of any controller fault conditions.
- ❖ contains an integral DSP that performs all audio processing including filtering and FM baseband modulation.
- ❖ interfaces with the RF and power supply sections of the transmitter to perform control and monitoring functions.
- ❖ provides local and remote interfacing for the transmitter. Local interfacing is performed via the local AUI touch screen on the front door of the transmitter and the controller module's front panel UI - a 4 x 20 graphic LCD display - and its adjacent keypad. The AUI and controller UI each contain a menu-based series of pages that serve specific functions. The AUI is also available via remote access. The remote interface PWB (A16) allows the user a more convenient method to interface with the transmitter from a remote location using discrete wiring.

The primary components of the control/monitor stage are the single-board computer (A4A1) and controller PWB (A4A1), which are part of the controller module (A4) and the module control/interface PWB (A3).

The UI interface PWB (A4A2), also part of the controller module, provides an interface between the controller UI and the module control/interface PWB (A3). It also contains the pushbutton switches (RF ON, RF OFF and LOCAL/REMOTE) and associated status LEDs that protrude through the front panel, adjacent to the UI.

The remote interface PWB (A16) provides a convenient method to remotely control and monitor of the transmitter. It contains push-button switches that provide backup control for the RF on/off, local/remote, power increase/decrease and reset functions. It also contains LEDs that serve as an alternate means to monitor status (local/remote and RF on/off) and various status and alarm parameters.

RF Drive Stage

See electrical schematic Figure SD-3. The RF drive stage converts the exciter's RF output to the intermediate RF level needed to drive the RF power modules. It consists of exciter A (A5), optional exciter B (A6) and RF drive splitter/changeover assembly (A7).

Exciter(s)

Exciter A (A5) and B (A6, optional) are the RF drive sources for the transmitter. They accept the external audio program information (see the GV2-10/GV2-7.5 Pre-installation Manual for details on various program input types). For dual exciter applications, the exciters' main/standby operation is controlled using the local (or remote) AUI or the controller UI. The exciter outputs are applied to the RF drive splitter/changeover assembly (A7). The exciter provides a nominal RF drive signal of 110 W (in analog mode) at 98 MHz.

See also the Audio Path Block Diagram in [Figure 3.1.2 on page 3.1.10](#).

RF Drive Splitter/Changeover Assembly

See also electrical schematic Figure SD-33. The RF drive splitter/changeover assembly (A7) controls the routing of the main exciter and, if applicable, the standby exciter and provides the RF drive signals for the four RF power modules. The assembly is comprised of the splitter/changeover PWB (A7A1) and the 4-way RF drive splitter/attenuator PWB (A7A2).

Exciter Relay Control - Dual Exciters Only

The RF drive outputs from exciters A and B are applied to the RF drive splitter/changeover assembly at A7A1J1 and A7A1J2 respectively. The Exciter Relay Control input (A7A1J3-4) is a signal applied from the control/monitor stage that controls relay A7A1K1.

- ❖ When exciter A is selected as the main RF drive source, the Exciter Relay Control input is open circuit and relay A7A1K1 will be de-energized. Exciter A's output will be applied to 3 dB hybrid coupler A7A1U1.
- ❖ When exciter B is selected as the main RF drive source, the Exciter Relay Control input is near ground potential (0 V) and relay A7A1K1 will be energized. Exciter B's output will be applied to 3 dB hybrid coupler A7A1U1.

Exciter Drive Splitter

The splitter/changeover PWB's 3 dB hybrid coupler (A7A1U1) is connected as a splitter. The RF drive source (A or B) selected by relay A7A1K1 is applied to A7A1U1's input. The signal is split into two equal amplitude signals that are 90° out-of-phase. These split signals are applied to 4-way RF drive splitter/attenuator PWB A7A2.

4-Way RF Drive Splitter/Attenuator

The 4-way RF drive splitter/attenuator PWB (A7A2) accepts the outputs from the splitter/changeover PWB's 3 dB hybrid coupler and splits it into four equal amplitude signals, using two 3 dB couplers identical to A7A1U1. The outputs of the 3 dB couplers are applied to attenuators, as required, for application to the four RF power modules. Attenuation values are set in order to balance the RF drive output levels.

RF Power Stage

See electrical schematic Figure SD-4. The RF power stage accepts the intermediate RF drive inputs from the RF drive stage and generates the final RF output. It consists of four RF power modules, the module control/interface PWB (A3), a 10 kW combiner/filter (A12), an output power probe (A15), a 3-input reject load assembly (A13) and a 3-way fan tray assembly (A14).

RF Power Module

See electrical schematic Figure SD-34. Each of the four RF power modules provides up to 3000 W (for GV10) or 2250 W (for GV7.5) of RF output power. Each module contains four power amplifier (PA) PWBs (A1 through A4), a splitter/interface PWB (A5), combiner PWBs (A6 and A7), and six cooling fans. The intermediate RF drive outputs from the RF drive stage are applied to the RF power modules via the module control/interface PWB (A3). Within each RF power module, the RF drive signal is sampled and then split to drive the module's four PAs. The PA Volts inputs from the associated power supply modules control the RF output of the four PAs.

Module Control/Interface PWB

See also electrical schematics Figures SD-9 through SD-16. The module control/interface PWB:

- ❖ interfaces with all RF power module inputs and outputs, except for the RF output.
- ❖ interfaces between the controller module (A4) and the rest of the transmitter, distributing forward and reflected power samples, exciter control signals, and metering for reject load assemblies and the RF drive splitter/changeover assembly.
- ❖ distributes RF drive power, PA voltage and PA bias voltage to the RF power modules.
- ❖ monitors critical parameters of the RF power modules, such as RF drive sample, reject power sample, heatsink temperature and cooling fan speed. Monitoring circuits determine if a parameter is out of tolerance and generate the necessary control signal to compensate for the out of tolerance condition or to inhibit the RF power module's associated power supplies.
- ❖ applies control signals to the power supply modules from the controller and also monitors status signals and critical meters from the power supply modules and applies them to the controller. The controller can inhibit the power supply modules, as necessary (RF off, PS Temp alarm), or enable the power supply modules (RF on).
- ❖ generates a sample of the PA voltage applied to each RF power module and applies it to the control/monitor stage.
- ❖ samples the RF power module meters and generates the necessary PA bias voltages for each RF power module's PAs.

Combiner/Filter

The 10 kW combiner/filter (A12) is a 2-stage combiner that accepts the RF outputs from four RF power modules and uses three 3 dB hybrid couplers to provide a single RF output. The first two hybrid couplers are used in a pair of 5 kW combiners, which each accepts the outputs of two RF power modules. The equal amplitude, 90° out-of-phase (quadrature) RF signals are combined at the 3 dB hybrid coupler outputs and applied to a third and final, 10 kW 3 dB hybrid coupler. Again, the equal amplitude, quadrature RF signals are combined. The combined output is applied to a 10 kW low pass filter before being applied to the output power probe (A15).

Any amplitude or phase imbalances between 3 dB hybrid coupler inputs cause a proportional signal to be applied to the reject load assembly. The amplitude of the 5 kW Rej Ld Pwr (1/2) and 5kW Rej Ld Pwr (3/4) signals (via J5 and J6) represents imbalance between the combined outputs of the first stage of combining. The amplitude of the 10 kW Rej Ld Pwr (1-4) signal (via J7) represents imbalance between the combined outputs of the second stage of combining (differences in pairs of RF power modules).

Reject Load Assembly

The reject load assembly (A13) provides a means to dissipate reject power from the outputs of the combiner/filter's 3 dB hybrid couplers. The reject load assembly contains power resistors to dissipate reject power. Cooling air for the reject load assembly is provided by fans in the fan tray assembly (A14). The module control/interface PWB (A3) monitors the speed of the cooling fans and regulates the voltage being applied to them accordingly.

Reject power generated by the combining stage of the combiner/filter is dissipated by resistors in the 3-input reject load assembly. Micro-strip transmission lines (on 4-input reject load PWB A13A1) in close proximity to the reject load signals induce three true RF sample voltages of the associated reject power. These samples are peak detected and applied to the control/monitor stage via the module control/interface PWB (A3). The module control/interface PWB provides an interface between the ac-dc power stage's Rej Fan Volts supply and the fan tray assembly's cooling fans. It also acts as the interface between the cooling fans' Rej Fan Tach signals and the control/monitor stage.

Output Power Probe

See electrical schematic Figure SD-36. The output power probe (A15) monitors the transmitter's forward and reflected power and generates the Fwd Pwr Sample (A1J1) and Refld Pwr Sample (A2J1) signals applied to the control/monitor stage for protection and monitoring. RF monitor PWB A3 provides a nominal 2.2 V (GV10) or 1.8 V (GV7.5) rms [at 10 kW (GV10) or 7.5 kW (GV7.5)] signal at A3J1, which is applied to the panel mount connector (W8J1) behind the front door. This can be used with a modulation monitor or spectrum analyzer. RF sample PWBs A4 and A5 provide similar samples at A4J1 and A5J1. These samples are applied to exciter B (if used) for use by the remote AUI's spectrum analyzer display.

GV7.5 / GV10 BLOCK DIAGRAM

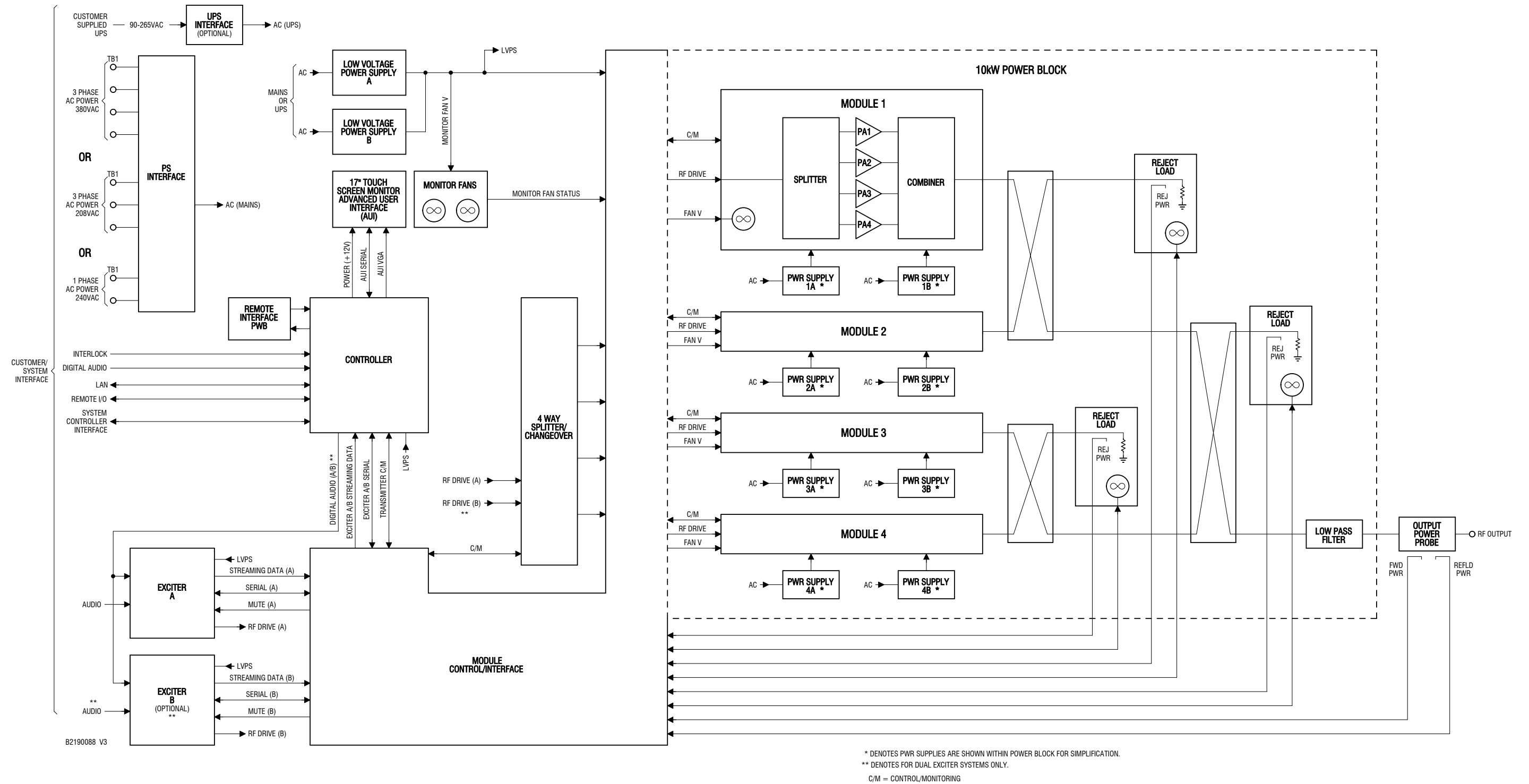

Figure 3.1.1: GV2-10/GV2-7.5 Transmitter Block Diagram

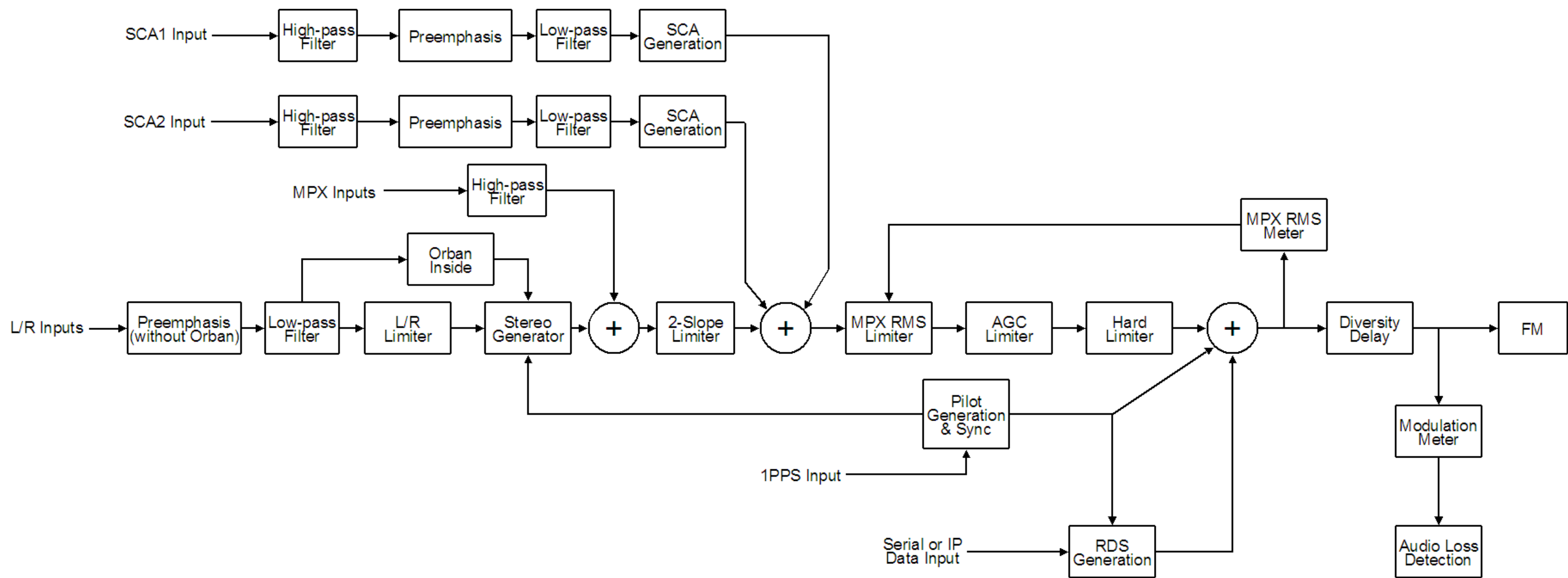

Figure 3.1.2: GV2-10/GV2-7.5 Audio Path Block Diagram

SECTION 3.2: OPERATING THE TRANSMITTER

This section provides information about operating the GV2-10/GV2-7.5 transmitter:

- [User Interface Options - see page 3.2.4](#)
- [Advanced User Interface \(AUI\) - see page 3.2.9](#)
 - ❖ [AUI Pages - see page 3.2.15](#)
- [Managing and Displaying Dashboard Panels - see page 3.2.20](#)
 - ❖ [Describing Dashboard Panel Options - see page 3.2.22](#)
 - ❖ [Alarms - see page 3.2.24](#)
 - ❖ [Audio Inputs - see page 3.2.24](#)
 - ❖ [Modulation - see page 3.2.25](#)
 - ❖ [Dashboard Meters - see page 3.2.25](#)
 - ❖ [Spectrum Analyzer - see page 3.2.27](#)
- [AUI Main Menu - see page 3.2.35](#)
 - ❖ [Alarms - see page 3.2.36](#)
 - ❖ [Meters - see page 3.2.37](#)
 - ❖ [Presets - see page 3.2.44](#)
 - ❖ [Scheduler - see page 3.2.62](#)
 - ❖ [Settings - see page 3.2.65](#)
 - ❖ [Audio Processing - see page 3.2.67](#)
 - ❖ [Exciter TCXO - see page 3.2.70](#)
 - ❖ [External 10 MHz - see page 3.2.71](#)
 - ❖ [FM Polarity - see page 3.2.72](#)
 - ❖ [Hardware Configuration - see page 3.2.73](#)
 - ❖ [HD/DRM - see page 3.2.77](#)
 - ❖ [Network - see page 3.2.82](#)
 - ❖ [Notifications - see page 3.2.84](#)
 - ❖ [Reboot Options - see page 3.2.87](#)
 - ❖ [Security Certificates - see page 3.2.88](#)

- ❖ [SNMP - see page 3.2.89](#)
- ❖ [Spectrum Mask - see page 3.2.91](#)
- ❖ [System Preferences - see page 3.2.92](#)
- ❖ [Thresholds - see page 3.2.93](#)
- ❖ [Time - see page 3.2.95](#)
- ❖ [Transmitter Info - see page 3.2.97](#)
- ❖ [Users - see page 3.2.98](#)
- ❖ [Remote I/O - see page 3.2.102](#)
- ❖ [Reports - see page 3.2.108](#)
- ❖ [Software - see page 3.2.112](#)
- ❖ [Air Chain - see page 3.2.114](#)
- ❖ [Sign Out - see page 3.2.117](#)
- [Controller Front Panel UI \(User Interface\) - see page 3.2.118](#)
 - ❖ [LCD Display \(UI\) - see page 3.2.118](#)
 - ❖ [Main Menu - see page 3.2.119](#)
- [Select Preset - see page 3.2.126](#)
- [User Settings - see page 3.2.127](#)
 - ❖ [Edit Presets - see page 3.2.128](#)
 - ❖ [Setting the Clock - see page 3.2.151](#)
 - ❖ [Network Setup - see page 3.2.152](#)
 - ❖ [Setting Pilot Sample Level - see page 3.2.155](#)
 - ❖ [Configure Test Signal Generator - see page 3.2.156](#)
 - ❖ [External 10 MHz Input - see page 3.2.158](#)
 - ❖ [Enabling the Scheduler - see page 3.2.159](#)
 - ❖ [Selecting FM Mask - see page 3.2.160](#)
 - ❖ [Setting User Thresholds - see page 3.2.161](#)
 - ❖ [Turn-On Delay Setting - see page 3.2.162](#)
 - ❖ [Ramp-Up Speed Setting - see page 3.2.163](#)

- View Status - see page 3.2.164
 - ❖ View Alarms - see page 3.2.164
 - ❖ View Meters - see page 3.2.165
 - ❖ Reset Alarms - see page 3.2.168
- Reset Alarms - see page 3.2.168
- Exciter Changeover Settings - see page 3.2.169
- System Settings - see page 3.2.171
 - ❖ Host Reboot - see page 3.2.172
 - ❖ Host Watchdog - see page 3.2.172
 - ❖ Firmware Update - see page 3.2.173
 - ❖ LCD Settings - see page 3.2.173
 - ❖ Exciter TCXO - see page 3.2.175
 - ❖ HD Optimizer - see page 3.2.176
 - ❖ HW Config - see page 3.2.178
 - ❖ FM Polarity - see page 3.2.184
 - ❖ Factory Settings - see page 3.2.185
- Remote I/O Settings - see page 3.2.190
 - ❖ Remote Inputs - see page 3.2.190
 - ❖ Remote Outputs - see page 3.2.192
 - ❖ Analog Outputs - see page 3.2.193
- Orban Audio Processor - see page 3.2.194
 - ❖ Configuring the Transmitter for the Orban Audio Processor - see page 3.2.195
 - ❖ Enabling the Orban Audio Processor for Preset Selection - see page 3.2.196
 - ❖ Selecting an Orban Audio Processor Preset - see page 3.2.198

User Interface Options

The user can interface with the GV2-10/GV2-7.5 using one of four methods:

- Locally, using the 17-inch front panel touch screen AUI (Advanced User Interface) (see [Advanced User Interface \(AUI\)](#), on page 3.2.9).
- Locally, using the controller module's front panel display and its navigational buttons (see [Controller Front Panel UI \(User Interface\)](#), on page 3.2.118) and the RF On, RF Off and Local/Remote control push-buttons (see [Controller Pushbuttons](#), on page 3.2.120). This interface is considered a backup to the local AUI.
- Remotely, via a LAN connection, using the Advanced User Interface (AUI) pages (same as local AUI interface).
- Remotely, via remote input/output (I/O) wiring connected to the controller (A4) or the remote interface PWB (A16) (see the GV2-10/GV2-7.5 Pre-installation Manual for I/O details).

See the complete menu hierarchy illustrated in [Figure 3.2.1](#) (for the local/remote AUI menu) and [Figure 3.2.2](#) and [Figure 3.2.3](#) (for the controller UI menu). When a user interfacing function can be performed from both the AUI and the controller UI, both are described in this section.

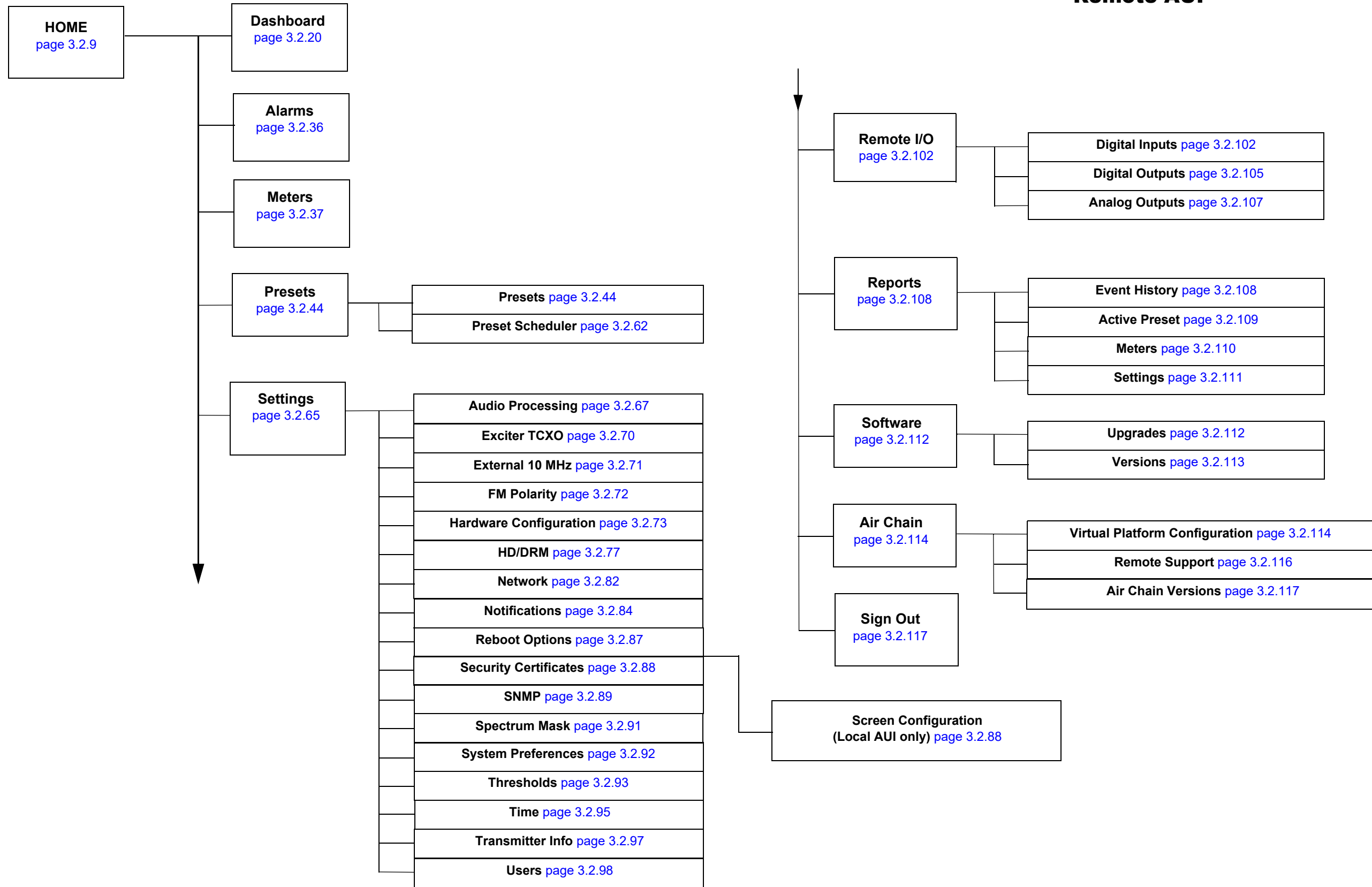
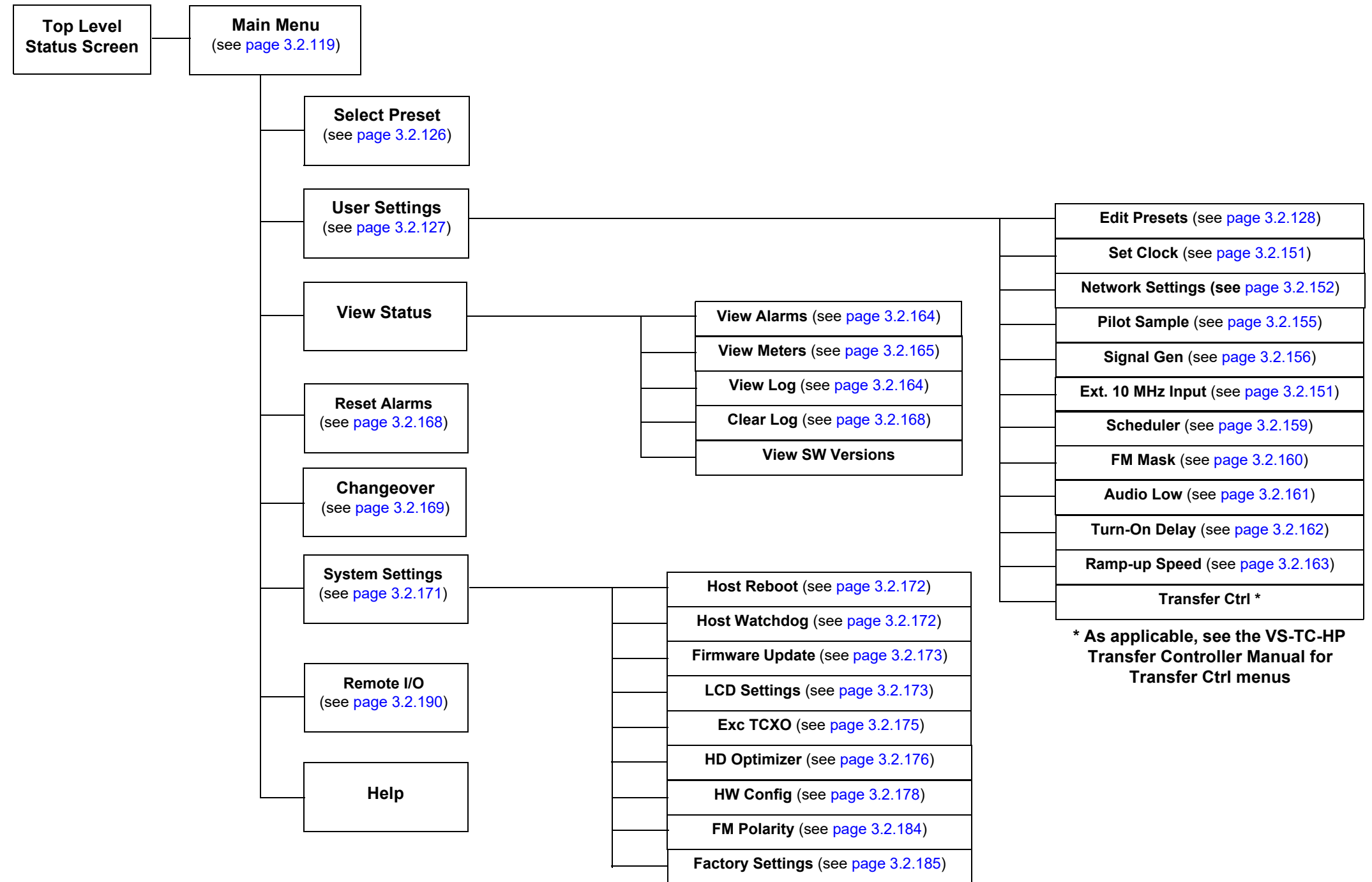

Figure 3.2.1: GV Transmitter AUI Flow Diagram

Controller UI



* As applicable, see the VS-TC-HP Transfer Controller Manual for Transfer Ctrl menus

Figure 3.2.2: GV Transmitter - Controller UI Menu Tree (Sheet 1 of 2)

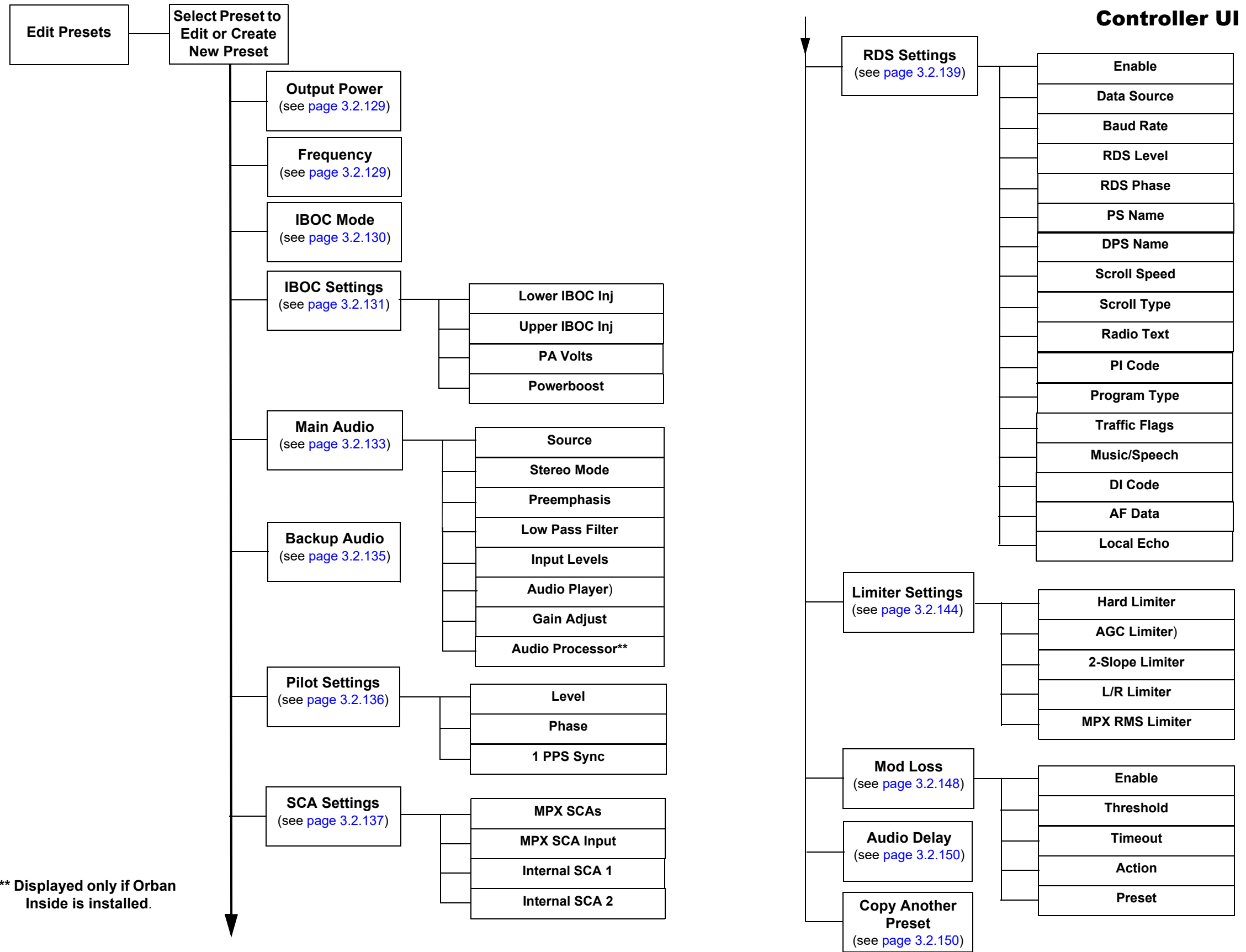

Figure 3.2.3: GV Transmitter - Controller UI Menu Tree - Edit Presets (Sheet 2 of 2)

Advanced User Interface (AUI)

The GV2-10/GV2-7.5 has an Advanced User Interface (AUI) that is displayed on a 17-inch, colour LCD screen mounted on the front of the transmitter (see [Figure 3.2.4](#)). You can access the AUI:

- locally via the touch screen, or
- remotely using a PC and a web browser, directly or through a switch or network - via the controller module's (A4) rear panel LAN connection or the remote interface PWB's (A16) LAN connection (J1), behind the front door.

NOTE: It is recommended the browser history be cleared before viewing the remote AUI.

This section includes the following topics:

- [Logging into the AUI, on page 3.2.10](#)
- [Advanced User Interface, on page 3.2.12](#)
- [Controller Front Panel UI \(User Interface\), on page 3.2.118](#)
- [Touchscreen Calibration, on page 3.4.4](#)

Figure 3.2.4: GV2-10/GV2-7.5 AUI

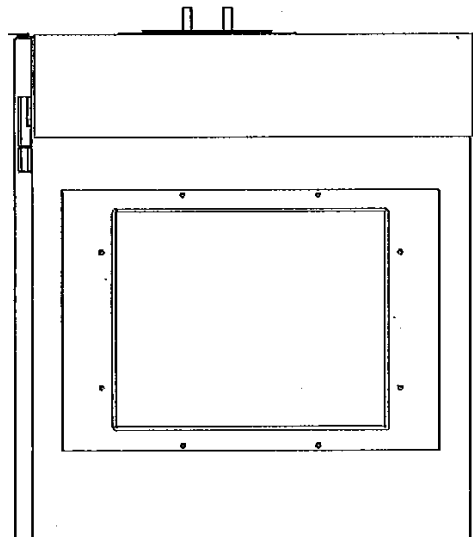

Logging into the AUI

The transmitter's AUI provides a means to restrict local and remote access to transmitter control functions to authorized users only. Users can create accounts that can be pre-defined to set access restriction from view-only (no control), full control (all permissions), custom (select permissions) and administrative control.

Remote Access

To access the transmitter's AUI remotely, perform the following steps:

1. Configure your network settings (see [Network](#), on page 3.2.82).
2. On your router or firewall software, open port 80 and close (restrict access to) all other ports. If you are using RDS data, open port 7005. If you are using SNMP, open ports 161 (Agent) or 162 (Traps).
3. When properly configured as noted above, the login menu (see [Figure 3.2.5](#)) will appear in your web browser when the IP address is accessed.
4. If the login menu does not appear, then the IP address is incorrect, however, if you enter the login credentials and press submit and you get an error, then your login is incorrect. Consult the documentation for the User Accounts page ([Users](#) on page 3.2.98).

Figure 3.2.5: AUI Login Menu

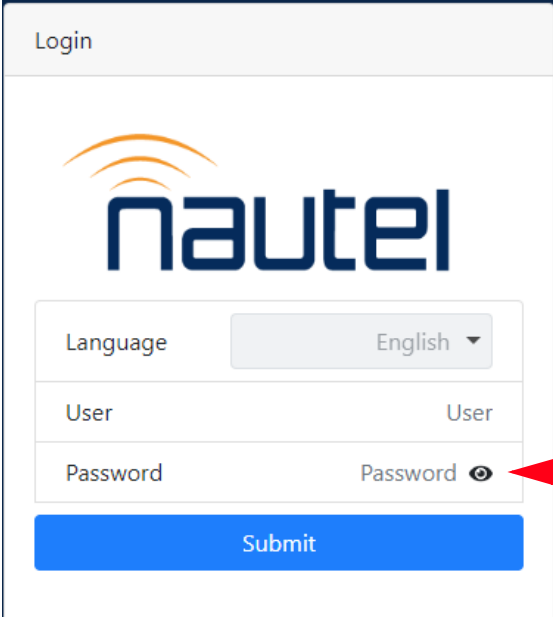

The screenshot shows a web browser window titled "Login". At the top center is the Nautel logo. Below the logo is a language selection dropdown menu currently set to "English". Underneath are three input fields: "User" with a placeholder "User", "Password" with a placeholder "Password" and an "eyeball icon" to its right, and a blue "Submit" button at the bottom. A red arrow points from the text "eyeball icon" to the icon in the password field.

-
5. Log in to the AUI by entering the appropriate parameters in the login window.
 - In the Language field (if applicable), press the down-arrow to review a drop-down menu displaying the available language options, and select one.
 - In the User field, there are two logins available: Admin and Viewer.
 - In the Password field, enter the password. If using Admin, the default password is change_me. If using Viewer, the default password is blank. Click on the eyeball icon to see the characters of the password.

NOTE: The Nautel AUI is factory configured with a default login username and password. Nautel recommends that you change the password to improve overall system security (see [Set or Change the Password, on page 3.2.100](#)).

- Press Submit to accept your login parameters and display the AUI home page. Note: The opening screen (the Home page) will have the layout from the previous login session.

NOTE: If you do not have a user account, it must be set up by an existing user with proper permissions. See [Setting Permissions, on page 3.2.99](#).

NOTE: If no login attempt is made after 60 seconds, a timeout feature will be activated and the web browser will need to be refreshed or the Retry button pressed (appears on AUI window after timeout) in order to attempt another login.

Local Access

When properly configured, (but without auto login selected) the login menu will appear on the transmitter 17-inch LCD touchscreen. Log into the AUI by entering the appropriate parameters in the login window.

- In the Language field, press the down-arrow to review a drop-down menu displaying the available language options, and select one.
- In the User field, enter the username. Default is "Nautel".
- In the Password field, enter the password. Default is blank.
- Press Submit to accept your login parameters and display the AUI home page ([Figure 3.2.7 on page 3.2.18](#)). Note: The opening screen (the Home page) will have the layout from the previous login session.
- If auto login is set, the AUI will appear automatically without the required previous steps.

Advanced User Interface

To access the remote AUI, you need a device with an HTML5 capable web browser that is connected to the GV2-10/GV2-7.5 - directly or through a switch - via its rear panel LAN connection (A1J8A). The AUI has a wide range of features, including:

- ❖ Dashboard (see [3.2.22](#))
- ❖ Alarms (see [3.2.36](#))
- ❖ Meters (see [3.2.37](#))
- ❖ Presets (see [3.2.44](#))
- ❖ Settings (see [3.2.65](#))
- ❖ Remote I/O (see [3.2.102](#))
- ❖ Reports (see [3.2.108](#))
- ❖ Software (see [3.2.112](#))

Each AUI page provides information about a specific transmitter function. All navigation through the AUI pages begins on the main screen (or Dashboard), shown in [Figure 3.2.6 on page 3.2.13](#).

Figure 3.2.6: Using the AUI (Dashboard Page shown)

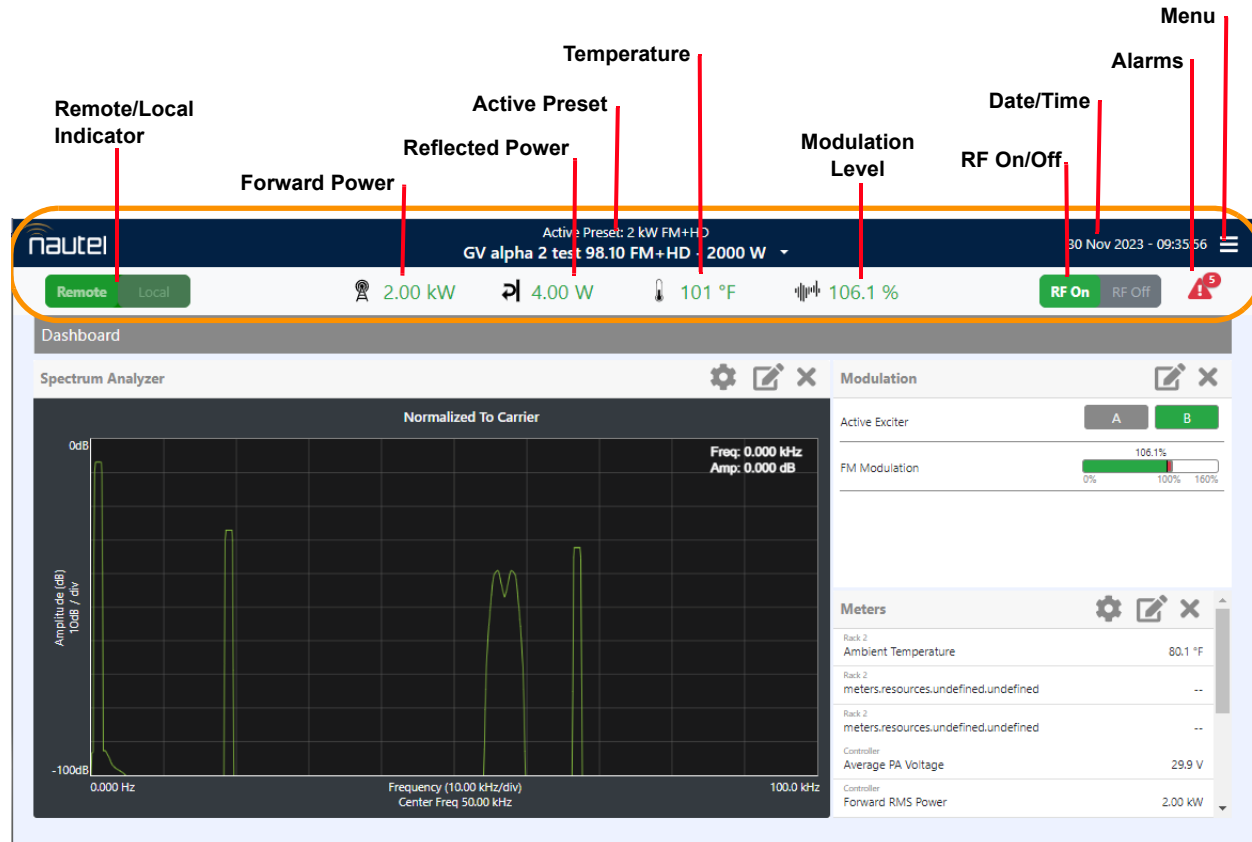

Display Area - displays user selected data and instrument panels

 - denotes status banner displayed on all AUI pages

The top banner is permanent on all AUI pages and includes:



- Nautel Logo: From any page, click the Nautel logo to return to the Dashboard page.
- Remote/Local: Buttons that determine the location of the operational control of the transmitter. The button that is highlighted green indicates the current setting. If Local is selected, only local control of the transmitter is possible. To change the local/remote status from the controller front panel display, see [AUI Menu page on page 3.2.18](#).

NOTE: Local changes can always be made while Remote access is enabled/disabled using the controller front panel's REMOTE button.

- Forward Power: Displays the current forward power level of the transmitter.
- Reflected Power: Displays the current reflected power level of the transmitter.
- Active Preset: Displays the name of the active preset (e.g., Preset 1), call sign, carrier frequency in MHz, mode (e.g., FM), and power set point. Click the down arrow to see other available presets and initiate a preset change (see [Managing Presets - Using the AUI on page 3.2.44](#)).
- Temperature: Displays the current temperature of the Controller's heatsink.
- Modulation: Displays the current modulation percentage of the transmitter.
- RF On/Off: Buttons that determine the on/off status of the transmitter's RF power stage. The button that is highlighted green indicates the current setting. Click RF On to enable the transmitter's RF power stage. Click RF Off to disable the transmitter's RF power stage.
- Date & Time: Displays day, month, year and current time. To set the time, see [Time on page 3.2.95](#).
- Active Alarms: Displays the critical-level alarms (red bell, with number) and maintenance-level alarms (amber warning, with number) that are currently active on the transmitter. Click on either symbol to go to the Alarms page (see [Alarms on page 3.2.36](#)), which provides details for current alarms as well as an option to view alarm history. When a critical-level alarm is being reported, the transmitter is in an 'off-air' state. When a maintenance-level alarm is being reported, the transmitter may still be 'on-air', but possibly at reduced power. When the transmitter is operating normally, no alarm symbols will display.
- Menu: Click to display further operations options, which allows navigation to various other pages (see [AUI Menu page on page 3.2.18](#)). Note: when Menu is selected, the three horizontal lines change to three vertical lines.

AUI Pages

Table 3.2.1 defines the available AUI pages.

Table 3.2.1: AUI Pages

AUI Page	Function	Page
Dashboard	Present critical data and instruments.	3.2.18
Panel Selector	Choose data and instrument panels for Dashboard.	3.2.20
Menu	Page navigation and AUI logout (see Menu options below).	3.2.35
Menu - Alarms	View active faults.	3.2.36
Menu - Meters	View Exciter and Controller meter lists.	3.2.37
Menu - Presets	Activate, create, and edit presets. Define and manage calendar-based preset schedule.	3.2.44
Menu - Settings	Manage all transmitter settings and options (see Settings options below).	3.2.65
Menu - Settings - Audio Processing	Select and modify Orban Audio Processing presets.	3.2.67
Menu - Settings - Exciter TCXO Calibration	Calibrate the 10 MHz Int-Ext Offset and set the TCXO Offset value.	3.2.70
Menu - Settings - External 10 MHz	Enable or disable the use of an external 10 MHz signal.	3.2.71
Menu - Settings - FM Polarity	Set the polarity for FM deviation; positive modulation signal yields positive frequency deviation or negative modulating signal yields positive frequency deviation.	3.2.72
Menu - Settings - Hardware Configuration	Configure the transmitter for any installed hardware that has optional variations (e.g., quantity of exciters or LVPS modules, fan speed) or is non-standard (e.g., UPS or audio processor).	3.2.73
Menu - Settings - HD/DRM	Configure HD/DRM settings.	3.2.77
Menu - Settings - Network	View network information status.	3.2.82
Menu - Settings - Notifications	Configure alarm notifications and email setup.	3.2.84

Table 3.2.1: AUI Pages

AUI Page	Function	Page
Menu - Settings - Reboot Options	Select Reboot Host, Active or Standby Exciter.	3.2.87
Menu - Settings - Screen Configuration (Local AUI only)	Select Enable Screen Saver and Timeout or perform a Touchscreen Calibration.	3.4.8
Menu - Settings - Security Certificates	Provides an option for enhanced security by uploading a security certificate.	3.2.88
Menu - Settings - SNMP	SNMP agent and traps configuration: enables notifications using a MIB browser and an alternative remote control and access.	3.2.89
Menu - Settings - Spectrum Mask	Select Spectrum mask type: FCC, ETSI or none.	3.2.91
Menu - Settings - System Preferences	Select temperature display: Celsius or Fahrenheit.	3.2.92
Menu - Settings - Thresholds	Set the main audio low and Low Forward Power trip levels.	3.2.93
Menu - Settings - Time	Select NTP, UTC, and set date, time, country and time zone.	3.2.95
Menu - Settings - Transmitter Info	View and enter transmitter name and serial number.	3.2.97
Menu - Settings - Users	Create and edit user accounts and permissions.	3.2.98
Menu - Remote I/O	Define remote inputs and outputs, monitor analog outputs.	3.2.102
Menu - Reports	View and download reports on transmitter operation: event history, active preset, meters, and settings.	3.2.108
Menu - Software - Upgrades	Select and manage installable software.	3.2.112
Menu - Software - Versions	View installed software versions and licenses.	3.2.113
Menu - Air Chain - Virtual Platform Configuration	Configure the DNS servers and LAN connections.	3.2.114

Table 3.2.1: AUI Pages

AUI Page	Function	Page
Menu - Air Chain - Remote Support	Enable remote support	3.2.116
Menu - Air Chain - Air Chain Versions	View installed Air Chain versions	3.2.117
Menu - Sign Out	Sign out of the AUI session.	3.2.117

AUI Menu page

NOTE: Any menu item or feature in the Remote AUI that is grayed out is not available or is disabled.

From the AUI's top banner, click the Menu button to view the Menu page (see [Figure 3.2.7](#)). From this page, you can select one of the following sub-menus:

Figure 3.2.7: Main Menu Page

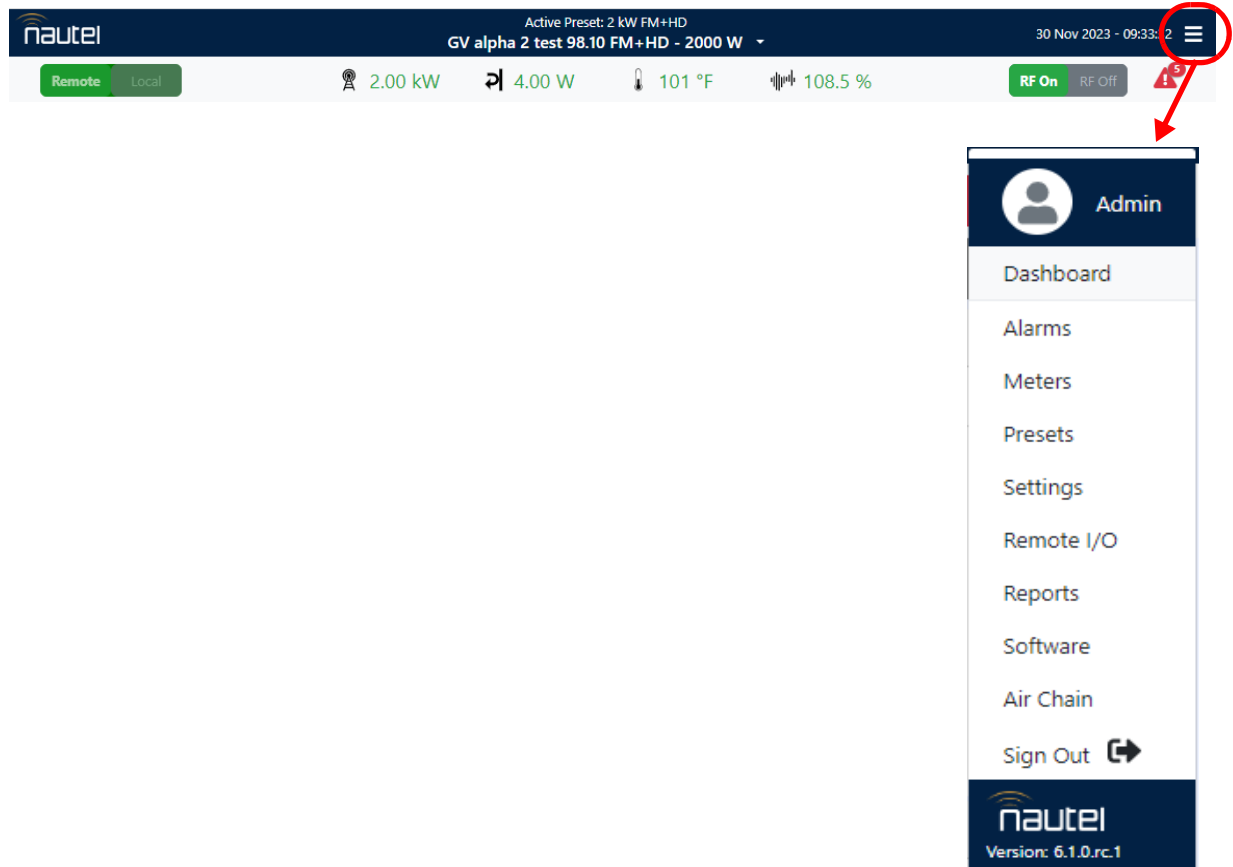

- ❖ Select Alarms to view, download or reset any current alarms (see [Alarms - see page 3.2.36](#)).
- ❖ Select Meters to view real time meters, selectable for Exciter (or HD Exciter), Power Module, Controller or Rack (see [Meters - see page 3.2.37](#)).
- ❖ Select Presets to view, load or edit available presets, create new presets, or to view, create or edit a preset schedule (see [Presets - see page 3.2.44](#)).

- ❖ Select Settings to access a sub-menu of settings options, including:
 - * Audio Processing (see [Audio Processing](#) - see page 3.2.67)
 - Exciter TCXO (see [Exciter TCXO](#) - see page 3.2.70)
 - External 10 MHz (see [External 10 MHz](#) - see page 3.2.71)
 - FM Polarity (see [FM Polarity](#) - see page 3.2.72)
 - Hardware Configuration (see [Hardware Configuration](#) - see page 3.2.73)
 - * HD/DRM (see [HD/DRM](#) - see page 3.2.77)
 - Network (see [Network](#) - see page 3.2.82)
 - Notifications (see [Notifications](#) - see page 3.2.84)
 - Reboot Options (see [Reboot Options](#) - see page 3.2.87)
 - Screen Configuration (see [Screen Configuration \(Local AUI only\)](#) - see page 3.2.88)
 - Security Certificates (see [Security Certificates](#) - see page 3.2.88)
 - SNMP (see [SNMP](#) - see page 3.2.89)
 - Spectrum Mask (see [Spectrum Mask](#) - see page 3.2.91)
 - System Preferences (see [System Preferences](#) - see page 3.2.92)
 - Thresholds (see [Thresholds](#) - see page 3.2.93)
 - Time (see [Time](#) - see page 3.2.95)
 - Transmitter Info (see [Transmitter Info](#) - see page 3.2.97)
 - Users (see [Users](#) - see page 3.2.98)

NOTE: * - If not installed on your transmitter, this option is shown greyed out and cannot be accessed.

- ❖ Select Reports to view or download the Alarm History (see [Reports](#) - see page 3.2.108).
- ❖ Select Software to view software versions or perform a software upgrade (see [Software](#) - see page 3.2.112).
- ❖ Select Air Chain to configure the DNS servers, LAN connections, remote support and view versions see [Air Chain](#) - see page 3.2.114)
- ❖ Select Sign Out to log out of the AUI session and return to the login menu. See [Software Versions](#) - see page 3.2.113. To log in again, use your remote PC's keyboard to enter your Username and Password, then click the Submit button. If you do not have a user account, see [AUI Pages](#) - see page 3.2.15.

Managing and Displaying Dashboard Panels

This section includes the following topics:

- ❖ Describing Dashboard Panel Options - see page 3.2.22
- ❖ Alarms - see page 3.2.24
- ❖ Audio Inputs - see page 3.2.24
- ❖ Modulation - see page 3.2.25
- ❖ Dashboard Meters - see page 3.2.25
- ❖ Spectrum Analyzer - see page 3.2.27
- ❖ Power Distribution - see page 3.2.29
- ❖ EQ Frequency Response - see page 3.2.30
- ❖ Lissajous Plot - see page 3.2.31
- ❖ AM-AM Correction - see page 3.2.32
- ❖ AM-PM Correction - see page 3.2.33

The AUI provides up to five measurement/status related tools, or panels, that you can select to display on the AUI's Dashboard (see [Figure 3.2.8 on page 3.2.21](#)).

Up to five panels can be displayed at one time, a larger panel on the left-hand side of the Dashboard and four smaller panels on the right-hand side.

To view all the panel options, select the Change Panel (edit) icon in the top, right corner of any displayed panel. You can also remove a panel by clicking the Remove Panel (X) icon in its top, right corner, then replace it by clicking the + symbol to see the panel options. See [Figure 3.2.8 on page 3.2.21](#) for a more detailed view of the panel options.

Figure 3.2.8: Panels displayed on Dashboard

Change Panel
Remove Panel

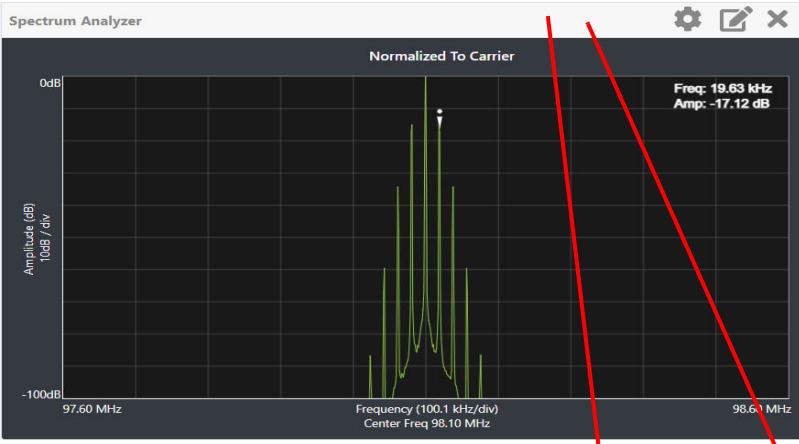

One larger panel displayed here

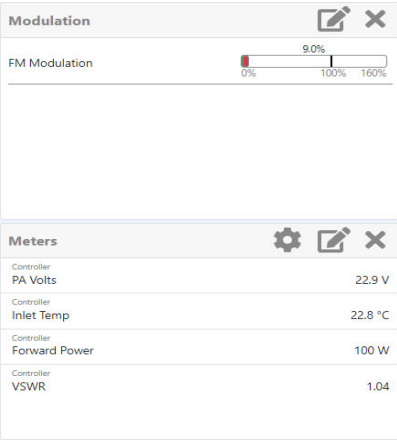

Up to four smaller panels displayed here

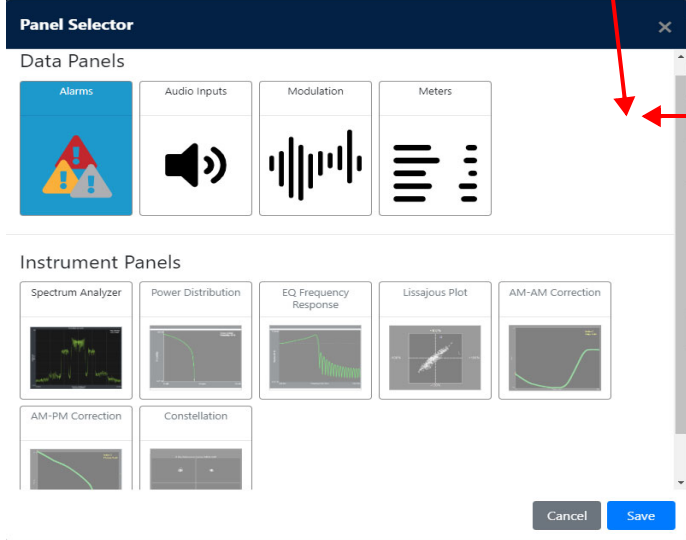

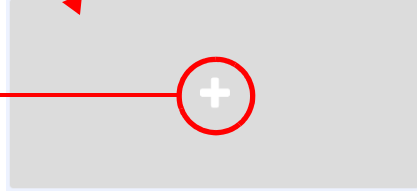

Describing Dashboard Panel Options

Click on the desired panel to display it. See [Table 3.2.2 on page 3.2.23](#) for a description of each panel, noting there are two types - Data Panels and Instrument Panels. Data Panels display read-only measurement data. Instrument Panels display graphical information with varying levels of cursor interactivity, depending on the panel. See [Figure 3.2.9](#).

The Reference column of [Table 3.2.2 on page 3.2.23](#) includes a section to find more detail for each panel.

Figure 3.2.9: Panel Options

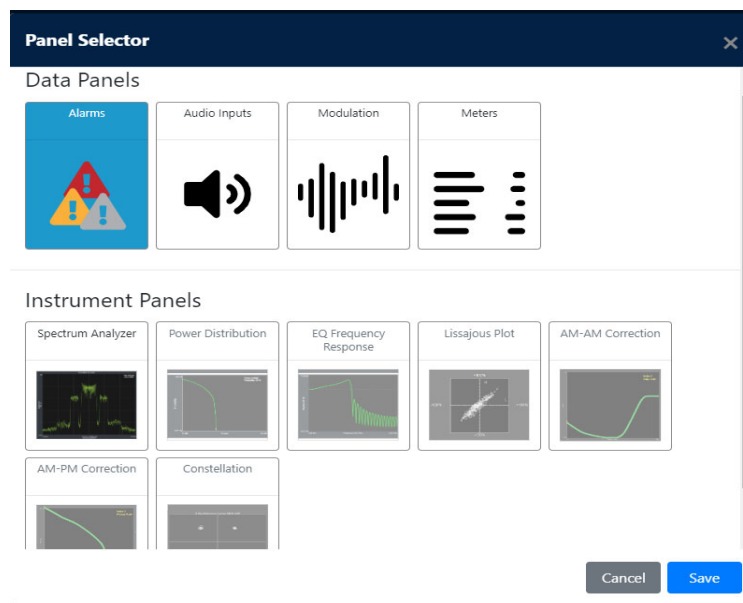

NOTE: If HD is not enabled, the following Instrument Panels will be greyed out:

- ❖ Power Distribution
- ❖ AM-AM Correction
- ❖ AM-PM Correction

Table 3.2.2: Dashboard Panels

Panel	Description	Page
Alarms	Active transmitter alarms listing.	3.2.24
Audio Inputs	Graphic meters for audio inputs.	3.2.24
Modulation	Active exciter indicator and graphic modulation meter.	3.2.25
Meters	Customizable transmitter meter list.	3.2.25
Spectrum Analyzer	Graphical instrument that visualizes RF output.	3.2.27
Power Distribution	Graphical instrument that displays a CCDF plot that indicates the probability of exceeding a given power level, based on the average power level. Aids in determining peak power capability.	3.2.29
EQ Frequency Response	Graphical instrument that displays the frequency response of the modulator's EQ filter.	3.2.30
Lissajous Plot	Graphical instrument that displays a Lissajous figure that represents the relationship between two applicable channels (either L and R or I and Q).	3.2.31
AM-AM Correction	Graphical instrument that displays the amplitude compensation being applied to the magnitude signal.	3.2.32
AM-PM Correction	Graphical instrument that displays the phase compensation being applied to the phase signal.	3.2.33

Alarms

See [Figure 3.2.10](#). Displays active transmitter alarms, including critical alarms (red) and warning alarms (amber). A scroll bar will display, as required. The alarms listed in this panel should match the number of critical and warning alarms shown in the top banner of the AUI. Go to the Menu - Alarms page for alarm details (see [Alarms on page 3.2.36](#)).

Figure 3.2.10: Alarms Panel

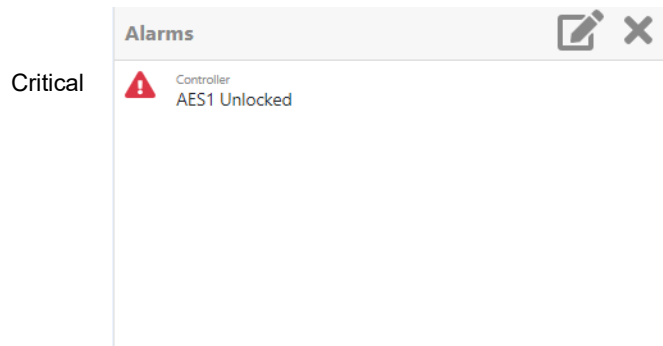

Audio Inputs

See [Figure 3.2.11](#). Displays preset audio inputs and monitor the levels relative to the input level defined in the active preset. Each audio input has a line that displays the current level (green bar), its peak level (black dot and shown numerically) and its full-scale value. If the input's level exceeds the full-scale value, the current level bar colour changes to red.

Figure 3.2.11: Audio Inputs Panel

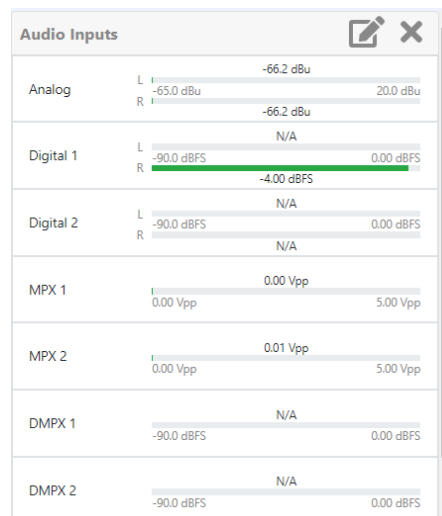

Modulation

See [Figure 3.2.12](#). Displays the active exciter's status (internal or external) and FM modulation level for the current preset. The current modulation level is displayed as follows: (green bar), its peak level (black line and shown numerically) and its full-scale value (typically 100%). If the input's modulation exceeds the full-scale value, the bar colour changes to red.

Figure 3.2.12: Modulation Panel

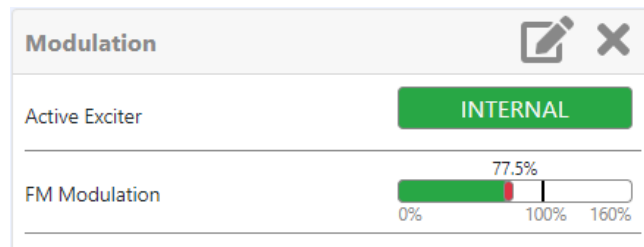

Dashboard Meters

See [Figure 3.2.13](#). Displays a customizable list of transmitter meters, including a scroll bar. Select a meter by clicking the box adjacent to the meter parameter, a blue check mark will indicate it is selected and click Save to display the parameters on the Dashboard. See [Figure 3.2.14 on page 3.2.26](#).

Figure 3.2.13: Dashboard Meters Panel

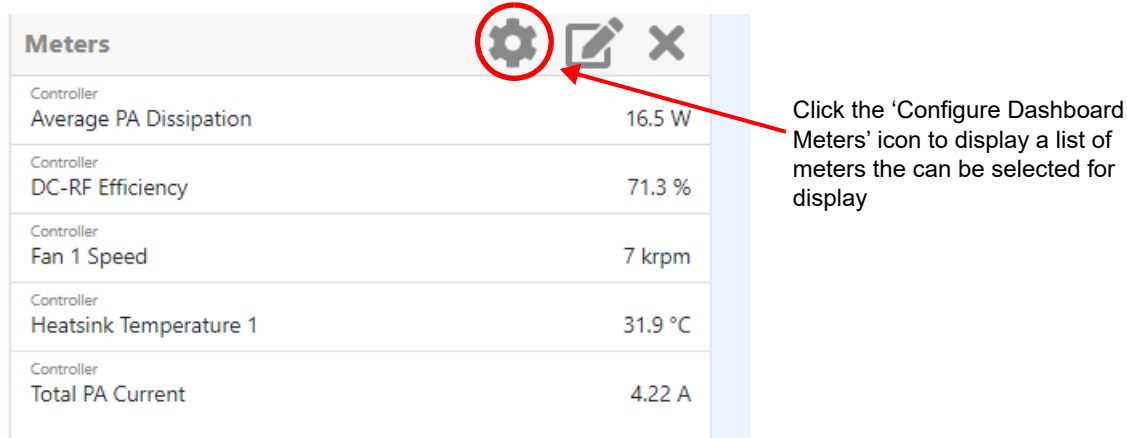

Click the 'Configure Dashboard Meters' icon to display a list of meters the can be selected for display

Figure 3.2.14: Dashboard Meters Selection

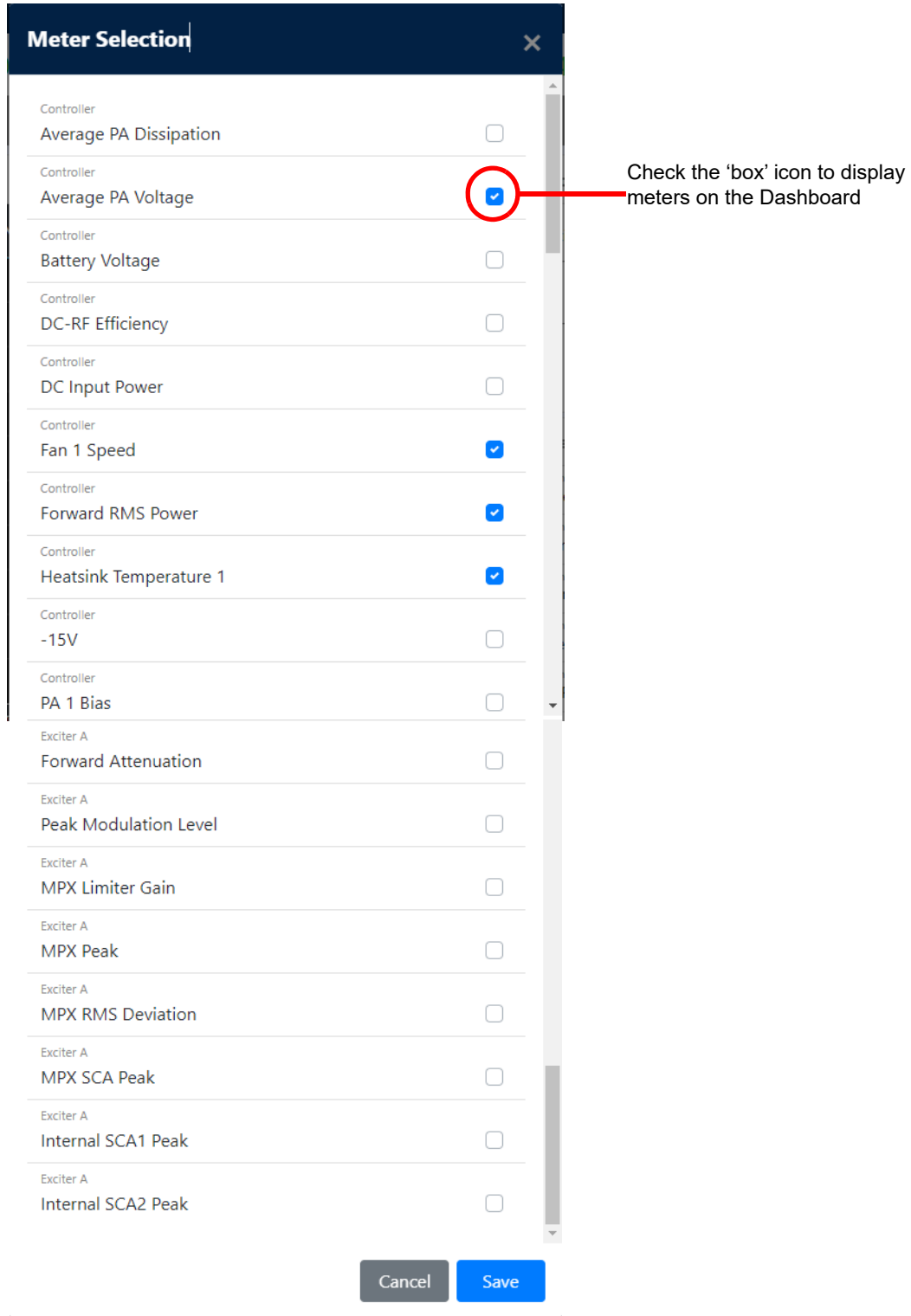

Spectrum Analyzer

See [Figure 3.2.15](#). The carrier level is normalized to its unmodulated carrier level at 0 dB. The graph center is always at the carrier frequency, as defined by the active preset's frequency.

Figure 3.2.15: Spectrum Analyzer Panel

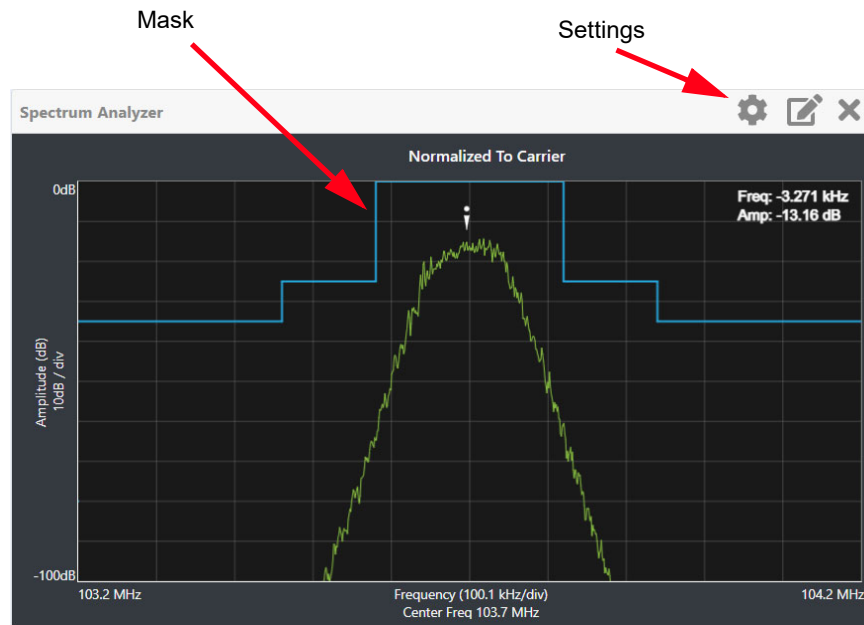

Masks are shown based on transmission mode and are defined by the latest versions of the following standards:

- IBOC: NRSC-5
- European Standard: ETSI EN 302 018-2
- FCC CFR 47, Part 73.317 and IC BETS-6e

Refer [Spectrum Mask](#), on page 3.2.91 to set the mask type.

NOTE: While very accurate, the spectrum analyzer may display artifacts (spurs) as some operating carrier frequencies that are a function of the analyzer and are not actually present on the output of the transmitter. If these spurious emissions are observed on the spectrum analyzer, Nautel recommends that a calibrated, external spectrum analyzer be used to verify the presence of spurs.

Click the panel to display a cursor on the nearest peak on the spectrum. The cursor position (frequency and amplitude) is noted in the upper, right-hand corner of the panel.

Click and hold the left mouse button and move the cursor to make fine adjustments.

Click the “Settings” button to gain access to spectrum settings (see [Figure 3.2.16](#)) such as:

- ❖ Resolution Bandwidth: determines the FFT bin size or the smallest frequency that can be resolved. Allowable range is 75 - 10,000 Hz. Default setting is 1000 Hz.
- ❖ Averages: determines the number of averages that the analyzer performs per sweep. Press the Clear Averaging button to restart the averaging process. Allowable range is 0 - 100 kHz. Default setting is 19.
- ❖ Span: determines the start and stop frequencies of the analyzer with the carrier frequency always at the center. Allowable range is 10 - 1200 kHz. Default setting is 1000 kHz.
- ❖ Measurement Options: determines the source of the spectrum plot that is being displayed. Selecting Internal (FM) uses the exciter’s RF signal, before being equalized (if applicable). FM spectrum analyzer bandwidth is defaulted to 1 MHz, but can be increased to 1.2 MHz. Selecting MPX bandwidth displays the entire composite baseband signal (100 kHz wide). For VS-HD systems, selecting Internal (Hybrid) displays the signal that will be produced by the exciter and selecting TX Output/External displays the exciter’s RF sample feedback to display the transmitter’s RF output spectrum.

Figure 3.2.16: Spectrum Settings

Setting	Value	Unit	Lock
Resolution Bandwidth	1090	Hz	Locked
Averages	10		Locked
Span	1000.972	kHz	Locked
Measurement Options	Internal FM		Locked

Close

NOTE: The FM spectrum analyzer displays the ideal spectrum generated by the DSP. It is not necessarily the same as the spectrum seen at the RF output.

Power Distribution

See [Figure 3.2.17](#). The exciter measures the relative power levels of the signal and determines the probability of exceeding a given power level, relative to the average power. The data is plotted in the Power Distribution Plot as a CCDF (complementary cumulative distribution function). The x-axis displays the relative power level in dB, with the reference representing the average power. The average power is 0 db. The y-axis displays the probability of exceeding that power level. This plot can be used to assess the distribution of a given signal, and provides an indication of the amount of peak power capability required from the transmitter in order to prevent peak clipping/distortion of the output signal.

Click on the panel to display a cursor in the approximate area. The cursor position (Power and Probability) is noted in the upper, right-hand corner of the panel. Select other areas of the panel to provide a coarse adjustment of the cursor position.

Figure 3.2.17: Power Distribution Panel

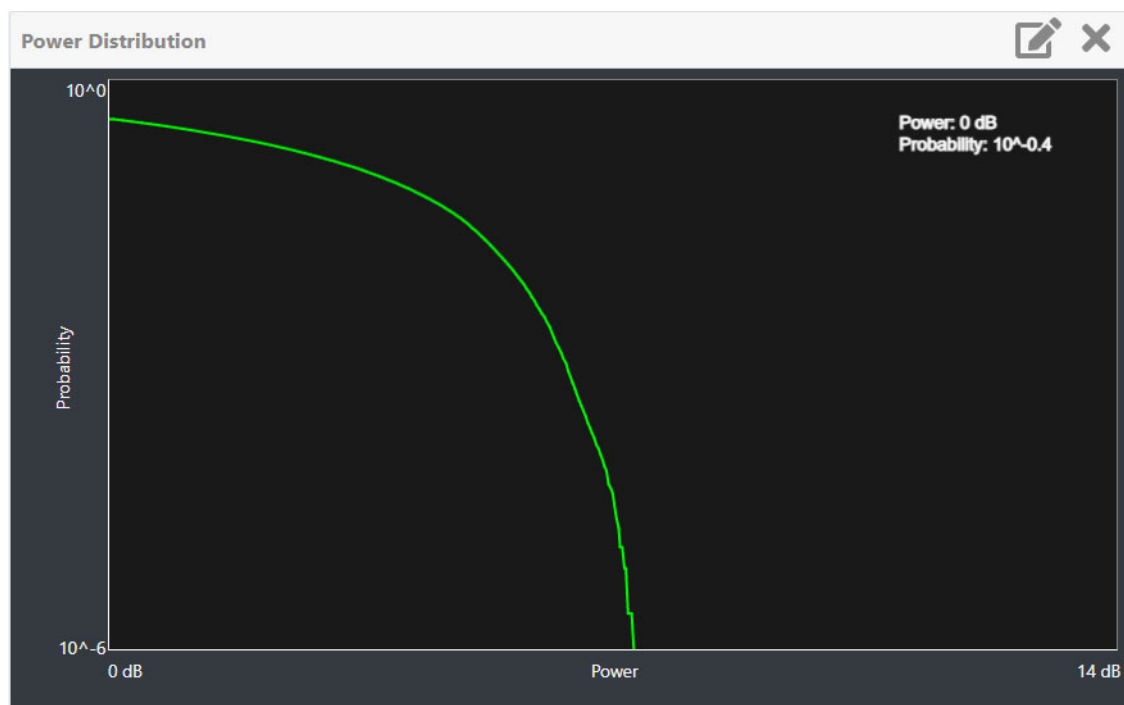

EQ Frequency Response

See [Figure 3.2.18](#). This panel displays the frequency response of the exciter's EQ filter. The panel displays the gain of the filter with respect to the magnitude and frequency of the modulating signal. A dashed line is displayed at the 0 dB level.

This tool is useful for installations featuring filter coefficients loaded to compensate for a channel combiner response.

Click on the panel to display a cursor in the approximate area. The cursor position (Frequency and Magnitude) is noted in the upper, right-hand corner of the panel. Select other areas of the panel to provide a coarse adjustment of the cursor position.

Figure 3.2.18: EQ Frequency Response Panel

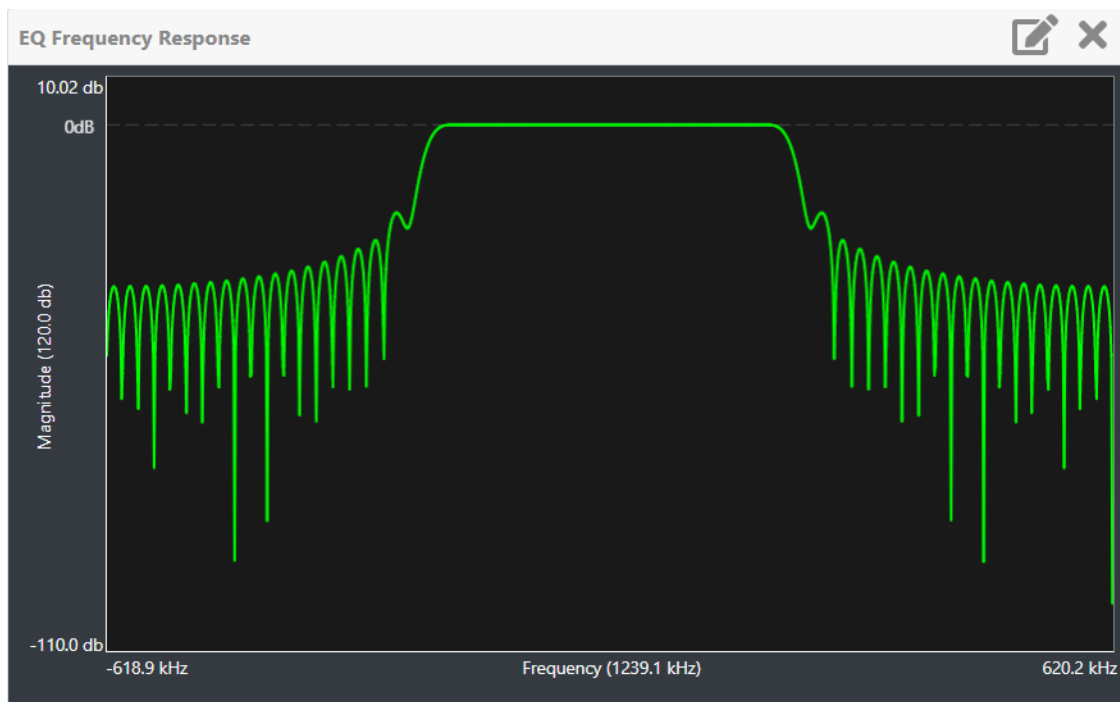

Lissajous Plot

See [Figure 3.2.19](#). This panel displays a Lissajous plot that represents either left and right audio content or a representation of the FM modulated signal (I and Q). I and Q will be automatically selected when using MPX as the main audio source. Left and right audio content is displayed for all other audio sources.

The plot consists of a group of sequential samples to allow signal analysis. In L and R mode, the L+R portion of the signal tends to dominate the plot, resulting in the majority of samples appearing in the lower, left and upper, right quadrants. In I and Q mode, signals that are of equal frequency and 90 degrees out-of-phase result in a circular display.

Figure 3.2.19: Lissajous Plot Panel

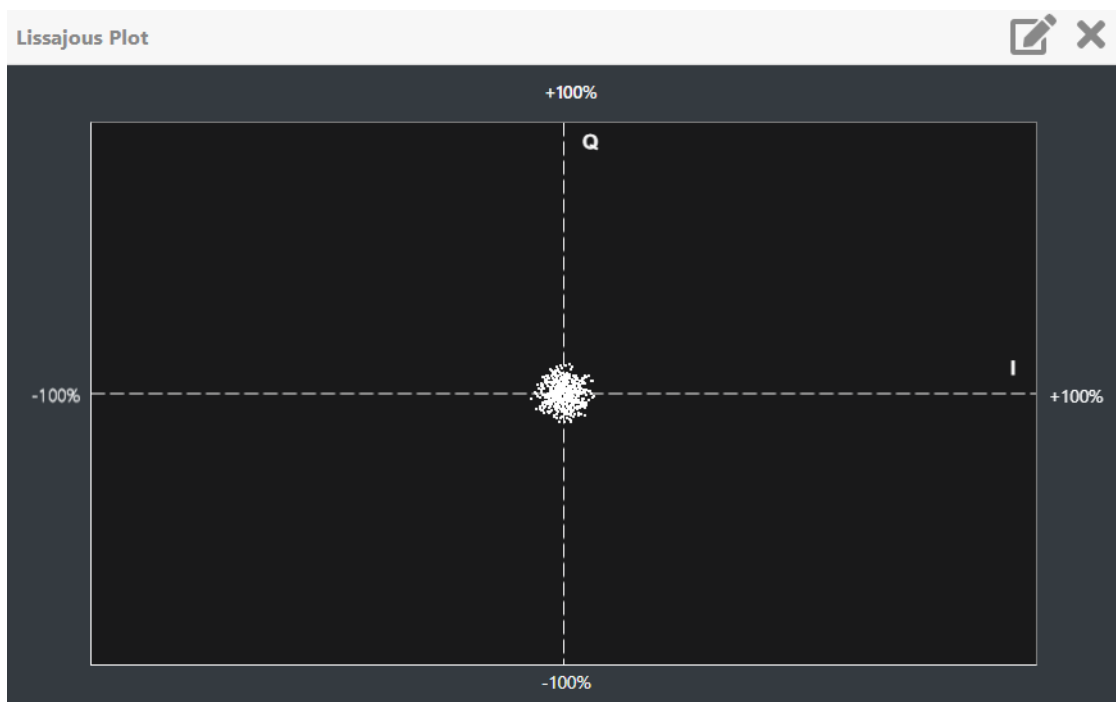

L & R mode shown for reference

AM-AM Correction

See [Figure 3.2.20](#). This panel displays the amplitude correction being applied to the RF drive signal in order to compensate for the transmitter amplitude (gain) response, which is non-linear. The x-axis represents the signal amplitude and the y-axis represents the gain correction applied for a given amplitude value. A look up table (LUT) index value of 0 represents low transmitter output power (RF drive). A LUT index value of 255 represents the maximum transmitter output power (RF drive).

The LUT curve can show that at low transmitter output power, more RF drive power is required to correct for low final stage amplifier gain - the curve sharply increases as it drops to 0 table value. (This low gain can also be overcome using additional bias, however pre-correction is more efficient.) Equally, the curve could also increase sharply at the top end of the table, suggesting that high RF drive power (gain) is required to connect for low gain at final stage amplifiers (PA compression peak limiting). It is technically the inverse of the transmitter's power amplifier gain response. Click or

Click on the panel to display a cursor in the approximate area. The cursor position (Index and Gain) is noted in the upper, right-hand corner of the panel. Select other areas of the panel to provide a coarse adjustment of the cursor position.

Figure 3.2.20: AM-AM Correction Panel

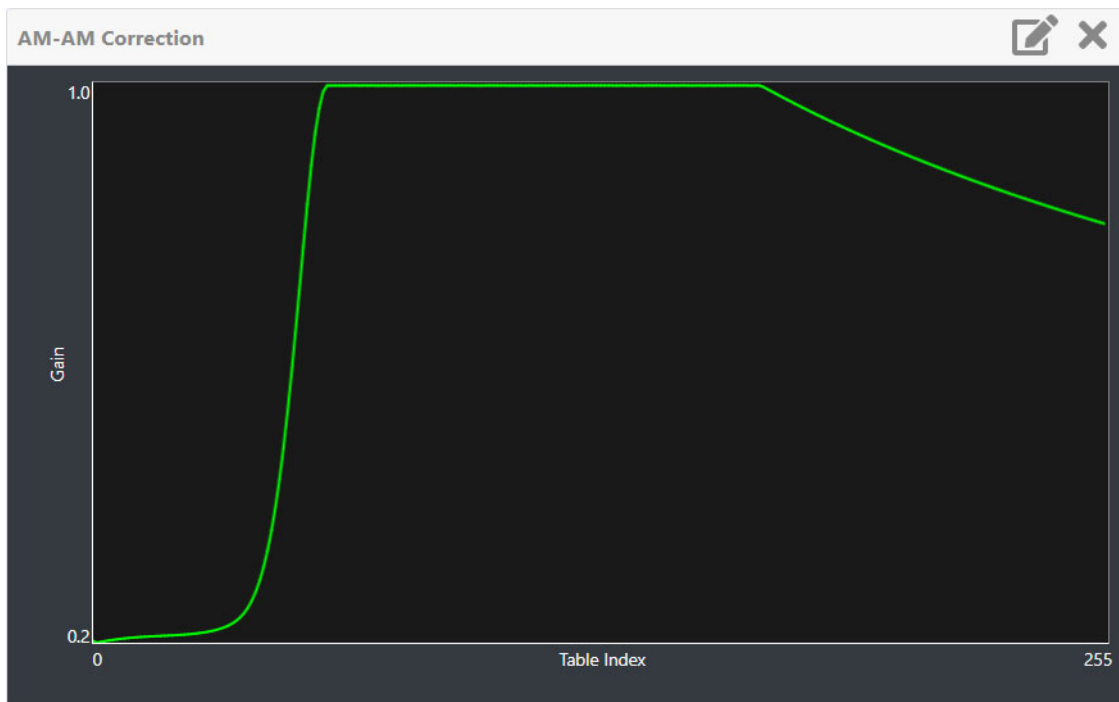

AM-PM Correction

This panel displays the phase correction being applied to the RF drive signal in order to compensate for the transmitter's (exciter +PA stage) phase non-linearity versus the output power. For example, in [Figure 3.2.21](#), the transmitter output power is low, so the curve in the plot shows positive phase correction. Inversely, a negative phase correction will be displayed in the plot given high output power levels. This correction is represented on the plot via the x-axis (table index value of between 0-255). The y-axis represents the phase shift correction applied for a given amplitude value.

Click on the panel to display a cursor in the approximate area. The cursor position (Index and Phase) is noted in the upper, right-hand corner of the panel. Select other areas of the panel to provide a coarse adjustment of the cursor position.

Figure 3.2.21: AM-PM Correction Panel

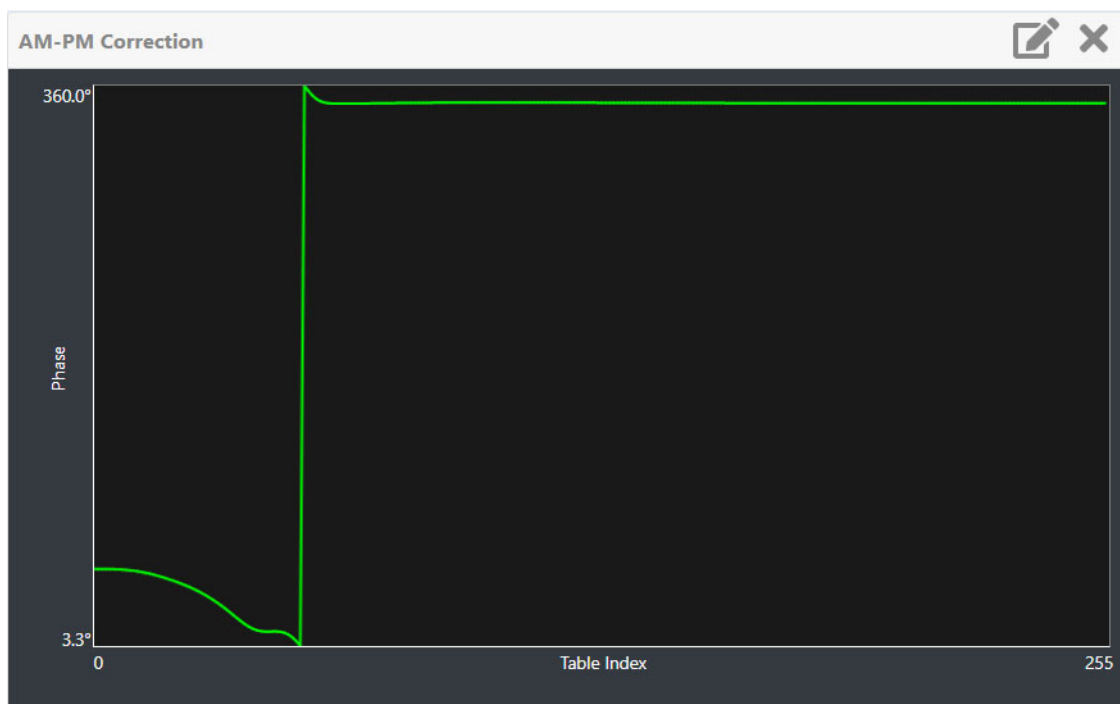

Constellation

See [Figure 3.2.22](#). The exciter constantly measures the transmitter signal and performs basic demodulation of the digital carriers. The Constellation panel displays the phase and amplitude of the symbols being modulated within an OFDM sub-carrier as dots on a cartesian graph. There are separate screens for each sub-carrier. Typically, the dots will be grouped together around the ideal data points. When the transmitter is on, the signal constellation display is representative of the transmitter output. When the transmitter is off, the display is representative of the forward path that will be transmitted.

Sub-carrier group details is shown in the lower, right section of the screen. Displayed information includes the sub-carrier group name, the bandwidth that the selected carrier group occupies and the modulation error ratio (MER) for the selected carrier group. MER quantifies the performance of the transmitted digital signal as the ratio between the RMS power of the ideal signal and the RMS power of the received signal's error vector. A higher MER value is characteristic of a smaller error, and therefore a higher quality signal. There is a NRSC minimum requirement of a MER value of no less than 14 dB.

Use the scroll bar to select a higher or lower sub-carrier for viewing. Some sub-carriers are for timing and synchronization. Others are modulated with data/content. Use the maximize or minimize buttons as required.

Figure 3.2.22: Constellation Panel

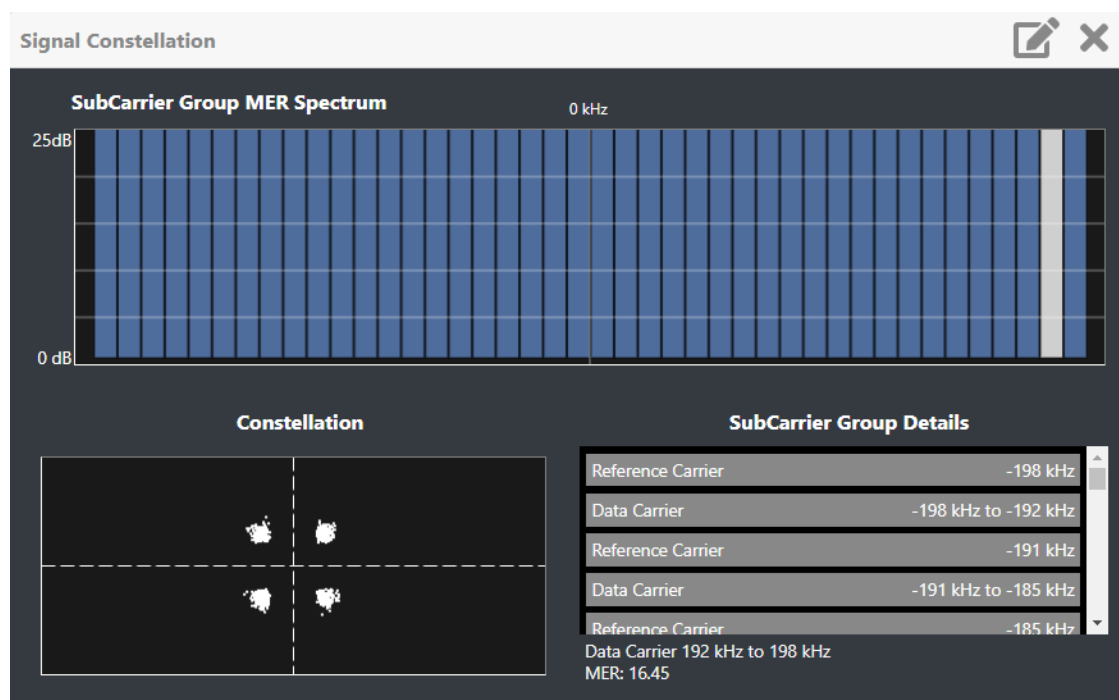

AUI Main Menu

The Main Menu contains the following features (see [Figure 3.2.23](#)):

- Dashboard
- Alarms (see [3.2.36](#))
- Meters (see [3.2.37](#))
- Presets (see [3.2.44](#))
- Settings (see [3.2.65](#))
- Remote I/O (see [3.2.102](#))
- Reports (see [3.2.108](#))
- Software (see [3.2.112](#))
- Air Chain (see [3.2.114](#))
- Sign Out (see [3.2.117](#))

Figure 3.2.23: Main Menu

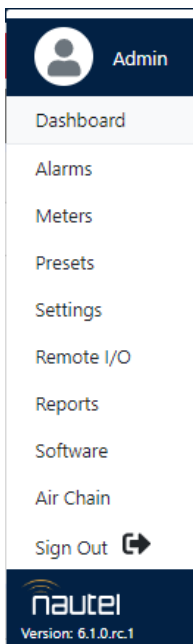

Alarms

You can view the GV2-10/GV2-7.5's operational status using the AUI's Alarm page. This page shows current active alarms to aid in fault diagnosis. To view, click the Alarms button in the AUI's main menu. See [Figure 3.2.24](#).

You can also use the controller front panel UI to view active alarms (see [View Status on page 3.2.164](#)).

Figure 3.2.24: Alarms page

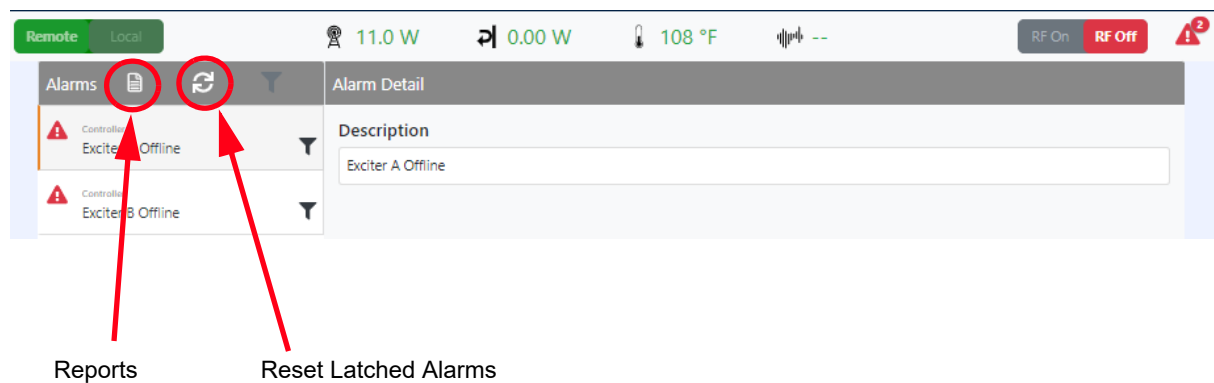

The Alarms page displays all active transmitter alarms. Alarms are listed by their host device (Controller Exciter A, Rack, etc.), alarm name and severity level [an orange ! indicates low severity/maintenance required (RF output not affected); a red ! indicates critical severity (RF output is reduced/inhibited)]. Refer to the GV2-10/GV2-7.5 Troubleshooting Manual for detailed information on alarm details such as root cause and troubleshooting tips.

Click the Reset Latched Alarms icon at the top, left of the Alarms screen to attempt to clear any latching alarms that are holding the transmitter in an "off-air" state. If the offending alarm has cleared, the transmitter should resume operation.

Click the Reports button at the top, left of the Alarms screen to go to the Reports screen where the user can see or download the event history. See [Reports on page 3.2.108](#).

Meters

The meters displayed in the AUI represents the active meters selected for the associated sub-sections and displays a real-time value.

Select the Meters page and select one of the following transmitter sub-sections:

- ❖ HD Exciter - see [Figure 3.2.25 on page 3.2.38](#) and [Figure 3.2.26 on page 3.2.39](#)
- ❖ Power Module - see [Figure 3.2.27 on page 3.2.40](#) and [Figure 3.2.28 on page 3.2.41](#)
- ❖ Controller - see [Figure 3.2.29 on page 3.2.42](#) and [Figure 3.2.30 on page 3.2.43](#)
- ❖ Rack - see [Figure 3.2.31 on page 3.2.43](#)

Meters can also be added to the Dashboard as a display panel. See [Dashboard Meters on page 3.2.25](#).

You can also view meters using the controller front panel UI (see [View Meters on page 3.2.165](#)).

NOTE: Meter values get updated typically every one or two seconds.

Figure 3.2.25: Meters - HD Exciter Page (1 of 2)

Meter Detail	
Meter Name	HD Exciter A
-15 V (V)	-15.3
+1.2 V (V)	1.19
+1.8V (V)	1.82
+3.3 V (V)	3.26
+5 V A (V)	4.84
+5 V B (V)	5.02
+15 V (V)	14.9
10 MHz Delta (ppm)	N/A
AGC Limiter Gain (%)	100
Analog Left Peak (dBu)	-85.7
Analog Right Peak (dBu)	-84.5
Battery Voltage (V)	N/A
Current Filter Tilt (dB/MHz)	0.45
DAC Gain (%)	91.1
Data MER LSB (dB)	N/A
Data MER USB (dB)	N/A
Deviation Peak (%)	19.0
Digital 1 Left Peak (dBFS)	-90.0
Digital 1 Right Peak (dBFS)	-90.0
Digital 2 Left Peak (dBFS)	-90.0
Digital 2 Right Peak (dBFS)	-90.0
Fan RPM (rpm)	5760
Fan Voltage (V)	38.8
Forward Attenuation (dB)	16.0
Forward Power (W)	258
Internal SCA1 Peak (dBu)	-83.7
Internal SCA2 Peak (dBu)	-83.7
IPA Volts (V)	38.6
LVPS Input Voltage (V)	38.7
Mask Delta (dB)	-58.2

Figure 3.2.26: Meters - HD Exciter Page (2 of 2)

MPX Limiter Gain (%)	100
MPX Peak (Vpp)	0.00
MPX RMS Deviation (%)	7.66
MPX SCA PEAK (Vpp)	N/A
PA Bias Voltage (V)	3.11
PA Dissipation (W)	164
PA Temp (°C)	39.0
PA Volts (V)	38.6
Pre-Amp Bias Voltage (V)	3.09
Pre-Amp Current (mA)	122
PWB Temperature (°C)	55.9
Reference MER LSB (dB)	N/A
Reference MER USB (dB)	N/A
Reflected Power (W)	5.51
Reverse Attenuation (dB)	7.00
Total Forward RMS Power (kW)	18.7
Total PA Current (A)	10.8
VSWR	1.34

Figure 3.2.27: Meters - Power Module Page (1 of 2)

Meter Detail						
Meter Name	PM1	PM2	PM3	PM4	PM5	PM6
Bias Voltage 1 (V)	2.82	2.82	2.80	2.82	2.86	2.82
Bias Voltage 2 (V)	3.00	2.84	2.86	2.90	2.84	2.82
Bias Voltage 3 (V)	2.86	2.86	2.86	2.90	2.86	2.77
Bias Voltage 4 (V)	2.82	2.84	2.86	2.86	2.82	2.82
Fan 1 Speed (rpm)	4710	4680	4890	4890	4890	4860
Fan 2 Speed (rpm)	4710	4620	4680	4590	4620	4650
Fan 3 Speed (rpm)	4590	4650	4530	4710	4680	4620
Fan 4 Speed (rpm)	4560	4560	4620	4740	4680	4590
Fan 5 Speed (rpm)	4680	4650	4650	4659	4620	4590
Fan 6 Speed (rpm)	4800	4680	4740	4830	4650	4710
Fan Voltage (V)	30.2	30.4	30.2	30.2	30.3	30.3
Final Stage Reject Power (W)	39.0	36.0	38.0	14.0	15.0	13.0
Heatsink Temperature (°C)	Value Not Set	Value Not Set	Value Not Set	Value Not Set	Value Not Set	Value Not Set
IPA Forward Power (W)	30.4	24.0	21.7	25.3	25.1	25.8
PA 1 Current (A)	22.6	15.1	20.5	16.7	20.2	17.7
PA 2 Current (A)	23.1	15.5	20.4	16.7	20.0	18.0
Heatsink Temperature (°C)	Value Not Set	Value Not Set	Value Not Set	Value Not Set	Value Not Set	Value Not Set
IPA Forward Power (W)	30.4	23.9	21.7	25.3	25.1	25.7
PA 1 Current (A)	22.6	15.1	20.5	16.7	20.2	17.7
PA 2 Current (A)	23.1	15.5	20.4	16.7	20.0	18.0
PA 3 Current (A)	16.0	22.7	17.5	21.0	17.5	20.6
PA 4 Current (A)	14.7	22.6	16.6	20.3	17.4	19.5
PA Voltage A (V)	38.5	38.3	38.3	38.1	38.1	38.2
PA Voltage B (V)	38.5	38.3	38.3	38.1	38.2	38.2
PS A Control Voltage (V)	38.8	38.8	38.8	38.8	38.8	38.8
PS A Current (A)	38.2	37.3	37.7	37.3	37.1	37.5
PS A Fan Speed (rpm)	13088	11720	12784	11392	12864	11536
PS A Input Current (A)	7.48	7.44	7.64	7.49	7.04	7.38
PS A Runtime (h)	2942.00	2553.00	2556.00	2550.00	3319.00	2548.00
PS A Temperature (°C)	70.0	69.0	70.0	69.0	71.0	69.0
PS A Voltage (V)	38.8	38.7	38.8	38.8	38.7	38.8

Figure 3.2.28: Meters - Power Module Page (2 of 2)

PS B Control Voltage (V)	38.8	38.8	38.8	38.8	38.8	38.8
PS B Current (A)	37.2	37.5	36.6	36.9	36.8	37.1
PS B Fan Speed (rpm)	14128	13472	12864	11504	12784	11136
PS B Input Current (A)	7.72	7.43	7.28	6.88	7.25	7.18
PS B Runtime (h)	3631.00	24181.0	3610.00	2916.00	3277.00	7184.00
PS B Temperature (°C)	72.0	71.0	70.0	69.0	71.0	69.0
PS B Voltage (V)	38.6	38.6	38.6	38.7	38.8	38.7

Figure 3.2.29: Meters - Controller Page (1 of 2)

Meter Detail	
Meter Name	Controller
+1.2 V (V)	1.19
+1.8 V (V)	1.83
+3.3 VDC (V)	3.34
+5 VDC (V)	4.91
+12 V A (V)	12.2
+12 V B (V)	11.9
+15 V (V)	15.0
5kW Reject 1-2 Power (W)	8.00
5kW Reject 3-4 Power (W)	11.0
5kW Reject 5-6 Power (W)	5.00
5kW Reject 7-8 Power (W)	12.0
5kW Reject Fan 1 Speed (rpm)	0.00
5kW Reject Fan 2 Speed (rpm)	0.00
5kW Reject Fan 3 Speed (rpm)	0.00
10kW Reject 1-4 Power (W)	11.0
10kW Reject 5-8 Power (W)	7.00
10kW Reject Fan 1 Speed (rpm)	0.00
10kW Reject Fan 2 Speed (rpm)	0.00
20kW Reject 1-8 Power (W)	1.00
Analog Forward Power (kW)	19.9
Average Active PA Power (W)	684
Average PA Dissipation (W)	48.0
Average PA Voltage (V)	38.3
Battery Voltage (V)	3.24
DC Input Power (kW)	23.4
DC-RF Efficiency (%)	85.0
Digital Forward Power (kW)	0.00
Fan 1 Speed (rpm)	0
Final Reject Fan 1 Speed (rpm)	0.00
Final Reject Fan 2 Speed (rpm)	0.00
Final Stage Reject Power (W)	253

Figure 3.2.30: Meters - Controller Page (2 of 2)

Forward RMS Power (W)	19912
LVPS Input Voltage (V)	39.3
PWB Temperature (°C)	42.0
Reflected Power (W)	35.0
RF Drive (W)	286
RF Output Return Loss (dB)	27.6
Splitter Fan 1 Speed (rpm)	0.00
Total Forward RMS Power (kW)	19.9
Total PA Current (A)	611
VSWR	1.09

Figure 3.2.31: Meters - Rack Page

Meter Detail		
Meter Name	Rack 1	Rack 2
+3.3 V (V)	3.28	3.37
+5 V (V)	4.97	5.02
+15 V (V)	15.0	14.9
Ambient Temperature (°C)	28.6	29.5
LVPS Input Voltage (V)	39.1	39.2
Reject Fan Voltage (V)	0.70	0.70

NOTE: Number of racks varies with transmitter model (GV20 shown for reference)

Presets

This section includes the following subjects:

- ❖ [Managing Presets - Using the AUI](#)
- ❖ [Activating presets using the AUI - see page 3.2.44](#)
- ❖ [Editing or creating presets using the AUI - see page 3.2.45](#)
- ❖ [Scheduler - see page 3.2.62](#)

Presets contain operational data (power, frequency, mode, program inputs) for the transmitter. You can create and manage presets using the remote AUI (see [Managing Presets - Using the AUI](#)).

Managing Presets - Using the AUI

The Presets page (see [Figure 3.2.32](#)) allows you to create up to 62 operating presets or edit existing presets. To view the Presets page, select Presets from the Dashboard menu or click on the Active Preset in the top banner. Many preset settings available on the remote AUI are also available on the controller front panel UI. In this case, if you change a preset setting on the remote AUI, it will also be reflected on the controller front panel UI, and vice versa.

Figure 3.2.32: Presets page



Activating presets using the AUI

There are two ways to activate a preset using the AUI:

- ❖ Click the Active Preset section in the top banner of any AUI page
- ❖ Enter the Presets page from the Dashboard.

Both methods will indicate the current active preset, by a green check mark next to its radio button (e.g., Daytime, see [Figure 3.2.32 on page 3.2.44](#)). If the current preset is not the desired one, click the radio button of the desired preset in the Available Presets list, or create a new preset or clicking the Clone Preset button and edit the preset.

If you select an alternate active preset, a confirmation prompt will appear. Select Close to cancel or Continue to activate the selected preset. Press the Delete button to delete the selected preset. Users cannot delete the current "active" (operational) preset or any preset that is referenced in the Remote I/O menu as either a remote input or output. Those links in the Remote I/O menu must be deleted before the associated preset can be deleted. Press Cancel to return to the Presets page.

Editing or creating presets using the AUI

When a presets page is opened from the main menu, the operational settings of the transmitter are displayed. They define the current operational state of the transmitter. Operational settings can be edited and then immediately activated by pressing the Save button.

To edit a saved preset, you must load that preset from the Presets page (see [Figure 3.2.32 on page 3.2.44](#)). If the edited preset was active before it was edited, saving the preset will update the preset, but the operational settings will not change. To update the operation of the transmitter, re-activate the preset through the top banner or Presets menu.

NOTE: When editing saved User presets, the best practice is to load a preset that is close to the desired configuration and then adjust its settings for the exact configuration.

In the Presets screen or top banner (see [Figure 3.2.32 on page 3.2.44](#)), a green checkmark appears next to the preset name to indicate which is the active preset.

When changes are complete, press the Save button. If you are creating a new preset, you can also enter a new name (e.g., Preset 4 - IBOC) in the preset window before clicking the Save button.

Parameters that can be edited are discussed in detail below.

To remove a preset, select it and press the Delete button.

NOTE: If the Delete icon is greyed out, the preset cannot be deleted as it is either used by another preset, the scheduler, or Remote I/O. A preset can also not be deleted if it is the only preset.

To ignore any changes, press Cancel to return to the Presets screen.

General

See [Figure 3.2.33](#).

Figure 3.2.33: General page

Update Preset	
General Audio SCA RDS Other Settings	
Preset Name	10kW FMHD -14
Preset ID	5
Output Power	10000 W
Frequency	98.10 MHz
Mode	FM+HD
HD PA Voltage	53.0 V
HD Power Boost Priority	Efficiency
HD Injection (Lower)	-14.0 dB
HD Injection (Upper)	-14.0 dB
<input type="button" value="Cancel"/> <input type="button" value="Save"/>	

- ❖ **Preset Name:** This field identifies the name of the current preset. Users must load a preset to directly edit this field.
- ❖ **Preset ID:** This field identifies the ID of the preset (ie., Preset 1).
- ❖ **Output Power:** Sets the output power level (in kW). Use the up and down arrows to adjust the power level. Output power limits are a function of the transmitter mode of operation (see Table 1-1 of the Pre-Installation Manual for RF output power ratings for this transmitter).
- ❖ **Frequency:** Set value. Valid frequencies are between 87.00 and 108.00 MHz.
- ❖ **Mode:** Set the overall transmission mode. Available options are:
 - FM: an analog only mode, transmits a carrier, frequency modulated with audio.
 - HD: all digital mode; this mode transmits the upper and lower digital sidebands of OFDM IBOC carriers. HD transmitter is typically high-level combined (coupler or spatial) with a paired FM only transmitter. This mode requires additional hardware.
 - FM+HD: also known as hybrid/simulcast or low-level combined, this mode transmits the analog carrier (FM modulated) and the upper and lower digital sidebands of OFDM IBOC carriers. This mode requires additional hardware.
- ❖ **DRM-FM:** transmits a DRM OFDM signal using the I/Q stream from a DRM modulator connected to the desired AES input. This mode requires additional hardware.

NOTE: Settings on the Presets tabs are shown/hidden based on the chosen settings. Not all settings are available in all modes.

Mode - additional calibration settings:

- HD Power Boost Priority: for FM+HD mode only. Select either MER (modulation error ratio or signal quality; default setting) or Efficiency.
 - ❖ Selecting Efficiency maximizes the aggressiveness of Nautel's HD PowerBoost process, an advanced peak-to-average power ratio reduction algorithm that prioritizes efficiency and power capability when reducing the peak-to-average power ratio, while ensuring that the MER of the transmitted HD signal meets transmission requirements.
 - ❖ Selecting MER minimizes the aggressiveness of the HD PowerBoost function and makes maximizing MER the priority. Transmitter efficiency and power capability will be reduced as a result.
- IBOC Injection (Lower): for FM+HD and HD modes, enter value, in dB, between -20 and -10 dB for the IBOC injection level of the lower sideband of digital carriers. This value determines the relationship between the digital carriers power and the analog carrier power. Example: -20 dB indicates that the total RMS power of the digital carriers will be 1/100 of the total RMS power of the analog carrier. -10 dB indicates that the total RMS power of the digital carriers will be 1/10 of the total RMS power of the analog carrier.
- IBOC Injection (Upper): for FM+HD and HD modes, enter value, in dB, between -20 and -10 dB for the IBOC injection level of the lower sideband of digital carriers. This value determines the relationship between the digital carriers power and the analog carrier power. Example: -20 dB indicates that the total RMS power of the digital carriers will be 1/100 of the total RMS power of the analog carrier. -10 dB indicates that the total RMS power of the digital carriers will be 1/10 of the total RMS power of the analog carrier.

NOTE: The actual digital sideband power is 3 dB less than that indicated in the upper or lower IBOC Injection fields; i.e. if -20 dBc is entered in the upper and lower IBOC Injection fields, the upper and lower digital sideband power levels are actually -23 dBc; this way, when added, the resultant total digital power level is -20 dBc.

For symmetrical sideband transmission: if -14 dBc IBOC Injection level is desired (total digital power of upper + lower sidebands is 4% of analog carrier power), set the upper and lower IBOC Injection levels to -14 dBc.

For asymmetrical sideband transmission, consider that the actual sideband power level is 3 dB less than that shown. For example, if the upper digital sideband IBOC Injection level is entered as -14 dBc, the actual power level will be -17 dBc. This is equally true for the lower digital sideband.

NOTE: The preferred option to maximize IBOC performance is by using the HD Optimizer feature (see [Spectrum Efficiency Optimizer, on page 3.2.81](#)). In this case, leave PA Volts setting at its default value (53.0 V).

Main Audio

See [Figure 3.2.34](#).

Figure 3.2.34: Main Audio page

The screenshot shows the 'Update Preset' dialog box with the 'Audio' tab selected. The settings are as follows:

Parameter	Value	Unit
Audio Source	Analog L/R	
Analog Level	0.0	dBu
Audio Mode	Stereo	
15 kHz Low-Pass	Disabled	
Pre-emphasis	0	μs
Gain Adjust	0.0	dB
Backup Audio	Disabled	
Backup MPX Level	1.0	Vpp

- Audio Source: Select from Analog L/R, MPX, AES EBU, Audio Player to AES2 or MPX over AES.
- Analog Level: applies to Analog Left/Right source only; enter value between -12 and +12 dBu, which represents the input voltage level that yields 100% modulation (Default is 0.0 dBu).
- MPX Level: applies to MPX source only. Set this parameter level in Vpp (typically 3.5 Vpp - 100% modulation value). The allowable range for this setting is between 1-5 Vpp.
- Digital Level: applies to MPX Over AES, AES/EBU 1 and Audio Player -> AES 2 sources only; enter value between -25.5 and 0 dBFS, with a typical setting of -4 dBFS (100% modulation value).
- Audio Mode: applies to Analog Left/Right, AES/EBU 1 and Audio Player -> AES 2 sources only; select Mono L, Mono R, Mono L+R or Stereo (selecting Stereo applies a 19 kHz pilot).
- Gain Adjust: applies to Analog Left/Right, AES/EBU 1 and Audio Player -> AES 2 sources only; allowable range is -20 to 10 dB. This configuration setting will increase the incoming signal level and yield a proportional increase in % modulation.
- Preemphasis: applies to Analog Left/Right, AES/EBU 1 and Audio Player -> AES 2 audio sources only; select 0 us, 25 us, 50 us or 75 us.
- 15 kHz Lowpass: applies to Analog Left/Right, AES/EBU 1 and Audio Player -> AES 2 audio sources only; select Enabled (applies 15 kHz low-pass filter to audio input) or Disabled.

- Backup Audio: When you set Backup Audio to Enabled, you can select a backup Audio Source and edit various parameters for the backup audio similarly to the main audio described above. The backup audio source, if enabled and present, will replace the main audio source if the main audio level is less than its user-determined trip threshold (see [Presets, on page 3.2.44](#)). The main audio source will be restored as the active source if it returns and is present for at least one second.

NOTE: AES2 may not be used as a backup source for AES1 when the internal exciter is used.

SCA

See [Figure 3.2.35](#).

Figure 3.2.35: SCA page

The screenshot shows the 'Update Preset' screen with the 'SCA' tab selected. The settings are as follows:

Setting	Value
MPX SCA	Disabled
SCA Reduction	0 %
Internal SCA1	Disabled
Internal SCA2	Disabled

Buttons: Cancel, Save

NOTE: Check your local broadcast regulatory body's guidelines for allowable modulation depth with SCAs or RDS enabled.

- **MPX SCA:** Connector (J7:A for SCA1, J7:B for SCA2) for use with an externally generated SCA; select Enabled or Disabled. When enabled, all the selections listed below are active.
 - ❖ **Input Level:** signal level that represents 10% modulation. Enter a value between 1 and 5 V p-p (typically 3.50 Vpp).
- **SCA Reduction:** Attenuation applied to the SCA input; set between 0 and 20% (used to reduce the modulation level of the main audio when SCAs are enabled; typically, for every 2% of SCA modulation, the main audio modulation must be reduced by 1%).

- Internal SCA1/2: Enable or disable the appropriate internal SCA (SCA1 or SCA2). When enabled, the settings listed below are active for the associated SCA signal (1 or 2).
 - ❖ SCA1 or SCA2 Mode: select FM (frequency modulated sub-carrier, typical) or DSB-SC (double side band suppressed carrier).
 - ❖ SCA1 or SCA 2 Input Level: enter value between -12 and +12 dBu, which represents the input voltage level that yields 10% modulation (typically 0.0 dBu).
 - ❖ SCA1 or SCA2 Injection Level: enter value between 0 and 20% (typically 10%); this level is added to the composite baseband signal.
 - ❖ SCA1 or SCA2 Frequency: enter value between 20 and 100 kHz (typically set to 67 kHz or 92 kHz).
 - ❖ SCA1 or SCA2 Preemphasis: select 0 us, 50 us, 75 us or 150 us.
 - ❖ SCA1 or SCA2 Lowpass Filter: select Enabled (applies 7.5 kHz low-pass filter to audio input) or Disabled.

RDS

For RDS operation, an external unit or software can send data to the exciter, serially or over IP. The exciter generates the RBDS/RDS carrier and injects the data; externally generated, or alternatively, the Presets page offer a means to configure internally generated data. See [Figure 3.2.36](#).

Figure 3.2.36: RDS page (shown disabled)

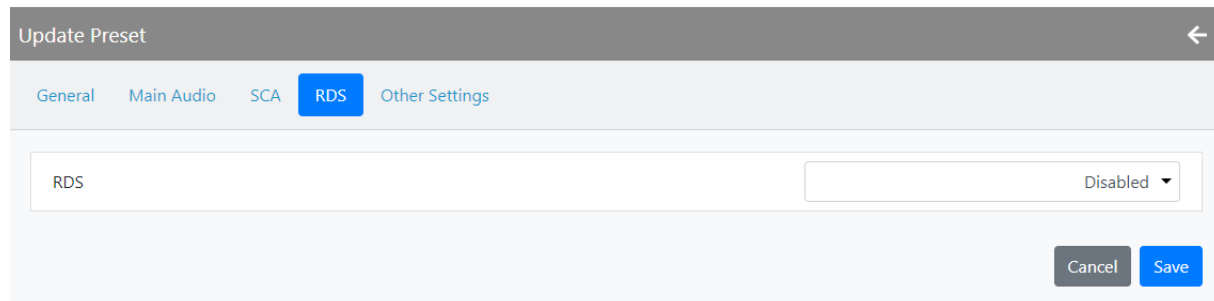

Refer to [RDS Remote Protocol](#), on [page 3.2.55](#) for information on using the ASCII protocol to remotely configure RDS settings and to observe the strings supported by Nautel.

NOTE: The UECP protocol is fully supported.

NOTE: The differences between RDS (European) and RBDS (North American) are not part of this manual. Presets created using the GV5/GV3.5 are compatible with either type.

- RDS: Select Enabled or Disabled (default is Disabled). When enabled, all of the selections below are active and the View RDS Demod option appears, which allows monitoring of the demodulated RDS content applied to internally generated RDS carrier:

NOTE: When using the internal data source, you must correctly enter all RDS fields - specifically PI Code or PS Name - to ensure proper reception of RDS information.

- Data Source: Select Internal, Ext_ASCII, UECP, IP_ASCII or IP_UECP.

NOTE: For ASCII over IP data or UECP over IP data, send RDS information to the IP address of the GV5/GV3.5, port 7005.

- Radio Text: Most RDS radios can receive short messages that may include information about the presenter, station or program you are listening to (e.g., a web address for the station). You can enter radio text up to 64 characters in length. Information is displayed on the receiver based on the receiver configuration and capability (e.g., maximum number of characters on the screen). Default is blank.

-
- Traffic Info: Select None, TA (Traffic Announcement), TP (Traffic Programme) or TA+TP. The receiver can often be set to pay special attention to this flag and, for example, stop the tape/pause the CD or re-tune to receive a traffic bulletin. The TP flag is used (set to 1) to allow the user to find only those stations that regularly broadcast traffic bulletins whereas the TA flag is used (set to 1) to signal an actual traffic bulletin in progress. These flags are set to 0 if they are not being used for traffic information. Default is None.
 - Baud Rate: (displayed only when Data Source is ASCII over Serial or UECP over Serial): Select 150, 300, 600, 1200, 2400, 4800, 9600, 19200, 38400, 57600 or 115,200 bps (default is 19200). Does not apply to the Internal data source.
 - Stereo: (bit 0 of DI, see NOTE below): select Stereo or Mono. This selection is a decoder identification operating mode flag. Default is Mono.

NOTE: Artificial Head, Compression Flag, Dynamic PTY and Stereo are part of the DI (Decoder Information) data (see UI editing screens on [Figure 3.2.102 on page 3.2.140](#)). RDS Data is provided as a single-digit hex input between 0 and F, that encodes the flags for the four settings as a 4-bit code. For example: hex number 3 is bit-represented by 0011, from bit 3 on the left to bit 0 on the right. This number is decoded to mean Stereo = Yes/Stereo (bit 0 = 1), Artificial Head = Yes/Enabled (bit 1 = 1), Compression = No/Disabled (bit 2 = 0) and Dynamic PTY = No/Static (bit 3 = 0).

- Scrolling Type: Select the type of scrolling to be used by the receiver - Word or Character. Word scrolling displays and transitions a maximum of 8 characters of the Scrolling PS Name at a time. Character scrolling still displays a maximum of 8 characters; however, transitions by one character of the Scrolling PS Name at a time. In both cases, transitions occur at the speed defined by the Scrolling Enable/Speed selection (Slow or Fast). The default selection is Word.
- Scrolling Enable/Speed: Determines the scrolling speed of the Scrolling PS Name. Select Off (disabled), Slow (transitions every 10 s) or Fast (transitions every 3 s). Default is Off.
- Scrolling PS Name: If used, enter up to 64 characters for the PS name that will scroll (if enabled) at the speed selected in the Scrolling Enable/Speed field. Information is displayed on the receiver based on transmitter configuration; however, is limited to 8 characters maximum. Default is blank.

NOTE: Words are defined by the spaces in the Scrolling PS Name. Words that exceed 8 characters will scroll each character until the entire word is displayed, then continue with the next word.

- Injection Level: Enter value between 0 and 10% (default is 5%). This level is added to the composite baseband signal.
- Alternate Frequencies: Select None or 1 through 25. This allows a receiver to re-tune to a different frequency providing the same station information (i.e., using translators or repeaters) when the first signal becomes too weak. This is often utilized in car stereo systems. Default is None.
- Phase: enter value in degrees between 0 and 360 (default is 0.0 degrees).

-
- Artificial Head (bit 1 of DI, see NOTE below): select Enabled or Disabled. This selection is a decoder identification operating mode flag. Default is Disabled.
 - Compression Flag (bit 2 of DI, see NOTE below): Select Enabled or Disabled. This selection is a decoder identification operating mode flag. Default is Disabled.
 - RDS Local Echo (displayed only when Data Source is ASCII over Serial). Select Enabled or Disabled (default is Disabled). When Enabled, the exciter RDS port transceiver will echo all inputs and controls received back to the terminal.
 - PTY: this coding of up to 32 (0 to 31) pre-defined programme types allows users to find similar programming by genre. Default is 0: NONE/NONE.
 - PTYN (programme type name): This field can be used for detailed description of the PTY by 8 digits. Example: if the PTY is 4 (Sport) a PTYN like "Football" could be transmitted. The PTYN is intended for displaying additional information only cannot be used for automatic station tuning like the PTY. The PTYN is optional. Default is blank.
 - Dynamic PTY (bit 3 of DI, see NOTE below): Select Dynamic or Static. This selection is a decoder identification operating mode flag. Default is Static.

NOTE: Artificial Head, Compression Flag, Dynamic PTY and Stereo are part of the DI (Decoder Information) data (see UI editing screens on [Figure 3.2.102](#) on [page 3.2.140](#)). RDS Data is provided as a single-digit hex input between 0 and F, that encodes the flags for the four settings as a 4-bit code. For example: hex number 3 is bit-represented by 0011, from bit 3 on the left to bit 0 on the right. This number is decoded to mean Stereo = Yes/Stereo (bit 0 = 1), Artificial Head = Yes/Enabled (bit 1 = 1), Compression = No/Disabled (bit 2 = 0) and Dynamic PTY = No/Static (bit 3 = 0).

- PI Code (hex) (Program Identification code): Enter four hex digits that represent the station call sign (e.g., PI=1AE5); this unique code is used to identify a broadcast station. Each station gets assigned a specific code with a country identifying prefix. In the USA the code is determined by applying a formula to the station's call sign (see www.nrcstandards.org). In Canada the code is determined using the Spectrum Management and Telecommunications tool found at www.ic.gc.ca. Contact your local broadcast regulatory body for details on determining your unique PI Code.
- PS Name (programme service name): This is simply a maximum 8-character "tagline" static display that represents the call letters or station identity name. Most RDS capable receivers display this information and, if the station is stored in the receiver's presets, will cache this information with the frequency and other details associated with that preset. Default is blank.
- Music/Speech: Select Music or Speech. Default is Speech.

RDS Remote Protocol. The following information is intended to assist users with remote RDS settings using the ASCII protocol. ASCII over IP does not provide exciter responses.

Assigning Settings: To assign a value to a setting, send the setting name, the equal sign (=) and the desired value. If the setting is valid, the exciter responds "OK". If the setting is invalid, the exciter responds "NO".

```
Examples: PI=1248 //set the PI code to 0x1248
          OK      // exciter responds with OK
          TA=2    // set the traffic announcement to 2 (bad command; only values 0 or 1 allowed)
          NO      // exciter responds with NO
```

Querying Settings: To determine the current value of a setting, type the setting name with a question mark (?) instead of an equal sign (=).

```
Examples: PI?      //query the current PI code
          1248     // exciter responds with "1248", the current PI code
```

Other Considerations:

Initial Values and Preset Changes

On startup, or when the RDS settings in the active preset differ from the last ones loaded, the preset's initial RDS settings (PS, PI, PTY, PTYN, RT, AF, etc.) will be loaded. If there is an active data source (UECP or ASCII via serial or IP), these settings may be updated externally.

The RDS settings from the preset will only be loaded again if they change, otherwise the working set from the external data source will continue to be used. This allows unrelated preset changes to adjust other settings without affecting RDS functionality.

Real Time Clock

The exciter/control PWB has a battery-backed real-time clock that keeps track of the time and date. It is possible the exciter's RDS generator could broadcast the incorrect time and date if this is not set correctly, so the broadcast of time must be enabled via ASCII or UECP each time the system is powered up. Until it is enabled, the time will not be broadcast again after a power failure.

TCP Usage

Use TCP port 7005. This is not user configurable. To use RDS over IP, the connection must be opened before each command.

List of Settings: [Table 3.2.3](#) lists the RDS settings supported by Nautel, including descriptions and examples.

NOTE: Remote setting of the RDS baud rate is not supported.

Table 3.2.3: Supported ASCII Settings for RDS

Setting	Name	Description/Example
PI=	Program Identification	Four hex digits representing the station call sign. Consult the RDS/RBDS specification for more information. Example: PI=1AE5
PS=	Program Service	Maximum 8-character ASCII "tagline" string describing the radio station. Example: PS=Q104-FM
PTY=	Program TYPe	Number, from 0 to 31, describing the station format. Example: PTY=24
PTYN=	Program TYPe Name	8-character ASCII string, also describing the station format. Example: PTYN=JAZZ24-7
TP=	Traffic Program	Set to 1 if the current program sometimes carries traffic information, otherwise set to 0. Example: TP=1
TA=	Traffic Announcement	Set to 1 if the current program is currently broadcasting a traffic announcement, otherwise set to 0. Example: TA=0 NOTE: Timeout of the TA flag is not implemented, so the RDS data source should ensure this flag is properly cleared.
AF1= ... AF25=	Alternative Frequency	If the station broadcasts on more than one frequency using translators or repeaters, these are typically set to each of the frequencies used in the broadcast network. Sample calculation for 98.5 MHz: $(98.5-87.8) \times 10 = 107$ Example: AF1=107 NOTE: there is no method to disable AFs in this protocol.

Table 3.2.3: Supported ASCII Settings for RDS

Setting	Name	Description/Example
DI=	Decoder Information	Single hex digit, range 0-9 and A-F (case insensitive) that encodes the flags Stereo(1)/Mono(0) - bit 0; Artificial Head (Yes=1, No=0) - Bit 1; Compression (Yes=1, No=0) - Bit 2; and Dynamic (Yes=1, No=0) - Bit 3 Example: DI=3 (Stereo, Artificial Head=Yes, Compression=No, Dynamic=No)
MS=	Music/Speech	Typically set to 1 if the station broadcasts music, otherwise set to 0. Example: MS=1
TEXT=	Radio Text	Accepts a 1 through 64 character ASCII string, displayed on receivers that support RDS radio text. Example: TEXT=Tears for Fears - Shout (1985)
ECHO=	Echo on/off	If set to 1, the RDS encoder will echo back characters that are sent to it. If set to 0, the encoder will only send responses. Example: ECHO=1
DATE=	Current UTC date	Format is strictly YYYY-MM-DD. Sets the current UTC date for 4A date/time broadcasts. This is a non-volatile setting. Example: DATE=2016-04-04
TIME=	Current UTC time	Format is strictly HH:MM:SS, 24-hour format. Sets the current UTC time for 4A date/time broadcasts. This is a non-volatile setting. Example: TIME=17:23:05
UTC=	UTC time zone offset	Range is 0 to 24, 32 to 56. Sets the current time zone. To calculate this value, multiply the time offset by 2 and add 32 if the time offset is negative. For Newfoundland (UTC-3.5), $3.5 \times 2 = 7$, and add 32 (since the time zone is negative) to yield 39. This is a non-volatile setting. Example: UTC=39
CT=	4A date/time enable	If set to 1, the exciter will broadcast a 4A RDS packet on the edge of every minute with the currently set UTC time/date. This is a volatile setting. Example: CT=1

Table 3.2.3: Supported ASCII Settings for RDS

Setting	Name	Description/Example
DPS=	Dynamic Program Service (scrolling command)	64-character ASCII string typically describing the radio station. Example: DPS=Q104-FM The Home of Rock N Roll
DPSR=	Dynamic Program Service Rate (scrolling command)	Number, from 0 to 2, describing the scrolling rate. 0 is off (default); the PS= command is displayed when DPSR=0 is used. 1 is slow; the DPS string will scroll at a rate of approximately 10 s. 2 is fast; the DPS string will scroll at a rate of approximately 3 s. Example: DPSR=2
DPSM=	Dynamic Program Service Mode (scrolling command)	Number, 0 or 1, describing the scrolling mode. 0 is word-scrolling; the DPS string will scroll word by word, or multiple words when they fit. 1 is character-scrolling; the DPS string will scroll character by character. Example: DPSM=0
REV not available for ASCII over IP	Software Version (special command)	Typing this command (no = or ?) returns the current RDS encoder software version. Example: REV // issue version command Nautel NVE RDS Encoder V1.0 // exciter response

Other Settings

See [Figure 3.2.37](#).

Figure 3.2.37: Other Settings page

Update Preset	
General Audio SCA RDS Other Settings	
Pilot Level	9.0 %
Pilot 1 PPS Sync	Disabled
Sample Output	Pilot
Audio Delay	Disabled
Mod Loss Timeout	Disabled
Hard Limiter	Disabled
AGC Limiter	Disabled
Two Slope Limiter	Disabled
Orban Processor	Disabled
L/R Limiter	Disabled
MPX Power Limiter	Disabled

Cancel Save

- Orban Processor: select Enabled or Disabled. If Enabled, enter:
 - Orban Preset: select one of the 27 Orban presets from the dropdown menu.

- Mod (Modulation) Loss Timeout: select Enabled or Disabled. If Enabled, enter:
 - Action: None (alarm only, no resulting action), Inhibit (inhibits the RF output and fans until the audio returns) or Change Preset (changes the active preset).
 - Mod Loss Preset: displayed only if Action is set to Change Preset. Select the preset from the drop down list that will activate upon the loss of a modulating signal, post the timeout period.
 - Mod Loss Timeout Minutes: sets the delay, in minutes, between modulation loss detection and the resulting action. Enter a value in the allowable range of 0 and 255 minutes.
 - Mod Loss Timeout Seconds: sets the delay, in seconds, between modulation loss detection and the resulting action. Enter a value in the allowable range of 0 and 59.9 seconds.
 - Mod Loss Threshold: sets the threshold for modulation loss detection. Enter a value in the allowable range of 0 and 100% (default is 0%).

- Pilot 1 PPS Sync: select Enabled or Disabled. If Enabled, enter:
 - Pilot Sync Phase: (enter value between 0 and 360 degrees; typically 0 degrees)

- Pilot Level: enter value between 6 and 12% (typically 9%); this level is added to the composite baseband

- MPX Power Limiter: If Enabled, enter MPX RMS Limit. This limit allows the broadcast signal to remain in compliance with the MPX power limits as suggested in ITU-R BS.412-9. While the limiter will keep the transmitter in compliance, it is recommended that adjustment to the processing be made in such a way to minimize the reductions performed by the limiter. Otherwise the signal will not take advantage of the peak modulation capability available.
 - MPX RMS Limit: enter value between -12 and 12 dBr (default is 0 dBr)

NOTE: MPX RMS is displayed as a percentage (%) on the meters screen. The percentage (%) equivalent for the dBr range shown above are 4.5% (-12 dBr) to 71.3% (12 dBr); default is 17.9% (0 dBr).

-
- **L/R Limiter:** This look-ahead limiter can be applied to the signal immediately before the stereo generator in the exciter. It has a fixed attack-time (and corresponding delay) of approximately 1 s. It can be configured to reduce the signal, if the gain setting is 0 dB or less, or can be used to perform an AGC function and boost quiet sections of the audio if a positive gain setting is used. If Enabled, enter the following parameters:
 - L/R Hold Time: enter value between 0 and 60 s (default is 5 s)
 - L/R Decay Time: enter value between 0 and 60 s (default is 5 s)
 - L/R Max Gain: enter value between -30 and 30 dB (default is 12 dB)

 - **Two Slope Limiter:** If Enabled, when the modulation level exceeds the Threshold, the gain of the audio input will instantly change according to the gain percentage setting (percentage of the initial gain, which is below the threshold). The input signal is distorted by the audio gain change.
 - Two Slope Threshold: enter value between 0 and 160% (default is 160%)
 - Gain: enter value between 0 and 100% (default is 50%)

 - **AGC Limiter:** If Enabled, when the modulation level exceeds the AGC Limit, the gain of the audio input will instantly decrease in order to reduce the modulation level below the AGC limit threshold. Recovery from this audio gain reduction is dependent on the Time Constant delay (fast attack, slow recovery). The input signal is briefly distorted by the audio gain reduction when the threshold is exceeded. Select Enabled or Disabled. If Enabled, enter:
 - AGC Limit: enter value between 0 and 160% (default is 120%)
 - AGC Time Constant: enter value between 0 and 1000 ms (default is 300 ms)

 - **Hard Limiter:** If enabled, the modulation level will be limited (audio signal clipped or distorted) if it exceeds the hard limit threshold. Select Enabled or Disabled. If Enabled, enter:
 - Hard Limit Value: enter value between 0 and 160% (default is 160%)

 - **Audio Delay:** Used to time align the receiver output of decoded analog and digital audio signals. Select Enabled or Disabled. If Enabled, enter:
 - Audio Delay Value: enter value between 0 and 12,000 ms (default is 0)
-

Scheduler

You can program a preset schedule for the transmitter. Select Preset Scheduler from the Settings page in the Dashboard menu (see [Figure 3.2.38](#)) to set the dates and times at which presets take effect. You can define up to 63 different schedule rules. The Scheduler can also be set using the controller front panel UI (see [Enabling the Scheduler on page 3.2.159](#)).

Figure 3.2.38: Scheduler page

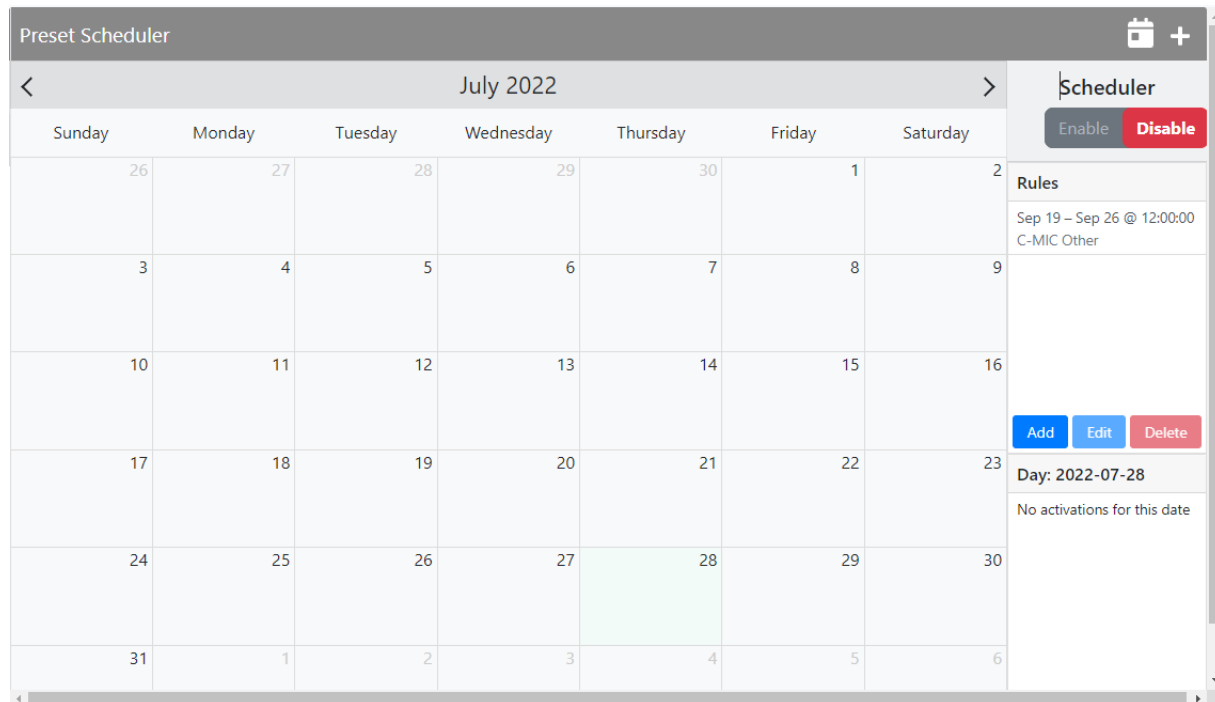

The Scheduler page displays a monthly calendar (e.g., September 2020). Use the < and > buttons to navigate between months.

By clicking on a specific date in the monthly calendar displays the Edit Rule page which contains the Timeframe, Days of the Week, and Time parameters, as applicable, for that day.

When in the Edit Rule list, you have the option to edit or delete an existing rule, or to create a new rule. Click the New or Edit button to display the Rule Explorer window (see [Figure 3.2.39 on page 3.2.64](#)). Click Delete to remove a rule from the list.

Use the Edit Rule window as follows:

- ❖ Use the drop-down menu to select the preset (e.g., Current Settings) for the rule. The preset's power, mode and frequency are displayed below the preset.
- ❖ In the Timeframe section, set the start (From:) and end (To:) dates for the rule. Start to end dates must be less than one year apart.
- ❖ In the Days of the Week section, select the days of the week on which the rule will apply.
- ❖ In the Time section, set the start (From:) and end (To:) times (hours and minutes) for the rule. Use the Repeat: field to establish a repeating cycle for the rule (e.g., every 24 hours).
- ❖ Unless you edit other rules first, you cannot select a date that occurs before the start of the previous rule or after the start of the following rule.
- ❖ Click the Save button to store the rule in the scheduler, the Cancel button to return to the Scheduler page or the Delete button to delete the rule.

When Scheduler: OFF appears, the transmitter will stop following the schedule and the active preset will be the preset that was operating when the scheduler was disabled.

Figure 3.2.39: Edit Rule page

The screenshot displays the 'Edit Rule' configuration page. It is organized into several sections:

- Presets:** A dropdown menu currently showing 'Example Preset 1'.
- Timeframe:** Two sets of dropdown menus. The first set is for months and days (e.g., 'January' and '1'), and the second set is for months and days (e.g., 'November' and '1').
- Days of Week:** A list of days with checkboxes. 'Monday', 'Wednesday', and 'Friday' are checked, while 'Sunday', 'Tuesday', 'Thursday', and 'Saturday' are not.
- Time:** Two time input fields with clock icons. The first is set to '06:00' and the second to '16:00'.
- Repeat Every:** A text input field containing '02:00'.
- Self Delete:** An unchecked checkbox.
- Preview:** A vertical calendar grid showing hours from 00:00 to 24:00. Horizontal orange lines indicate the active time slots, corresponding to the 06:00-16:00 timeframe.

At the bottom of the form, there are three buttons: a red 'Delete' button on the left, and blue 'Save' and grey 'Cancel' buttons on the right.

Settings

The Settings menu (see [Figure 3.2.40 on page 3.2.66](#)) contains the following features:

- Audio Processing (see [Audio Processing - see page 3.2.67](#))
- Exciter TCXO (see [Exciter TCXO - see page 3.2.70](#))
- External 10 MHz (see [External 10 MHz - see page 3.2.71](#))
- FM Polarity (see [FM Polarity - see page 3.2.72](#))
- Hardware Configuration (see [Hardware Configuration - see page 3.2.73](#))
- HD/DRM (see [HD/DRM - see page 3.2.77](#))
- Network (see [Network - see page 3.2.82](#))
- Notifications (see [Notifications - see page 3.2.84](#))
- Reboot Options (see [Reboot Options - see page 3.2.87](#))
- Screen Configuration (Local AUI only) (see [Screen Configuration \(Local AUI only\) - see page 3.2.88](#))
- Security Certificates (see [Security Certificates - see page 3.2.88](#))
- SNMP (see [SNMP - see page 3.2.89](#))
- Spectrum Mask (see [Spectrum Mask - see page 3.2.91](#))
- System Preferences (see [System Preferences - see page 3.2.92](#))
- Thresholds (see [Thresholds - see page 3.2.93](#))
- Time (see [Time - see page 3.2.95](#))
- Transmitter Info (see [Transmitter Info - see page 3.2.97](#))
- Users (see [Users - see page 3.2.98](#))

Figure 3.2.40: Main Menu - Settings

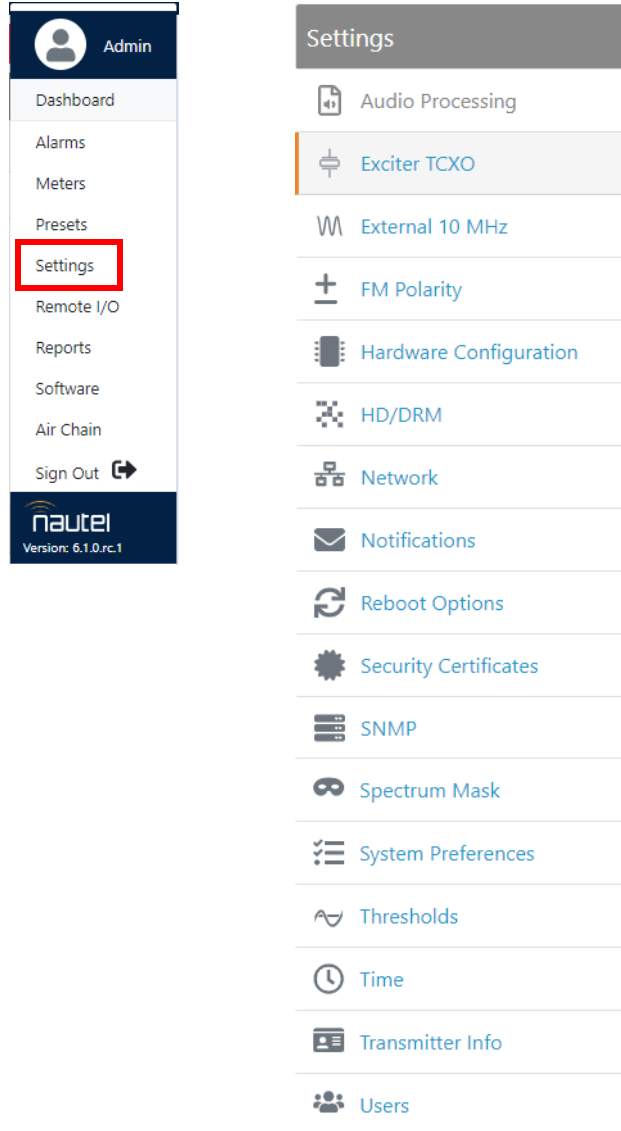

NOTE: For consistency, the Settings menu is the same for all transmitter series. If a transmitter does not have a feature installed or enabled, such as Audio Processing, that menu option is greyed out in the Settings list.

Audio Processing

This section describes how to configure and operate the Orban Audio Processor in your transmitter. There are 29 different Orban presets available. You can interface with audio processor functionality locally, using the controller front panel UI or the remote AUI. The extent of the features available depends on which interface is used.

Select an Orban audio processor preset using either the remote AUI (see [Orban Enabling - Using the Remote AUI](#)) or the controller front panel UI (see [Orban Audio Processor on page 3.2.194](#)).

NOTE: This section contains frequent reference to Orban's Optimod-FM 5500 Digital Audio Processor Operating Manual (see the link below). The equipment covered in the 5500 manual uses the same Orban audio processor as in your transmitter. The 5500 manual provides detailed information on the audio processor's functionality. If a discrepancy exists between the operational instructions in the Orban manual and this document, the latter shall prevail as this document is specific to operation with an GV5/GV3.5 transmitter. View the Orban Optimod-FM 5500 Digital Audio Processor Operating Manual online at:

http://www.orban-europe.com/downloads/5500/Documentation/5500_1.2_Operating_Manual.pdf

(the version number referenced in this URL is controlled by a third party and is subject to change)

Orban Enabling - Using the Remote AUI

In the Settings -> Audio Processing page, select the desired Orban Preset by clicking the circle to the left of the preset name, a green checkmark will indicate that the preset is enabled. See [Figure 3.2.41 on page 3.2.68](#)).

There are two types of Orban audio processor presets: Factory presets and Custom presets. Factory presets cannot be modified. When a factory preset control is changed, a new preset is automatically created. This preset's default name will be the same as the Orban preset with an asterisk (*) prefix (e.g., * EXTREME). Modified presets should be saved to a new name, otherwise they will be overwritten by any edits made to subsequent presets. A saved preset will display as a Custom preset in the Load or Save screens. Custom presets can be modified.

NOTE: When creating a name for a custom preset, the ' _ ' is an invalid character.

Figure 3.2.41: Settings - Audio Processing

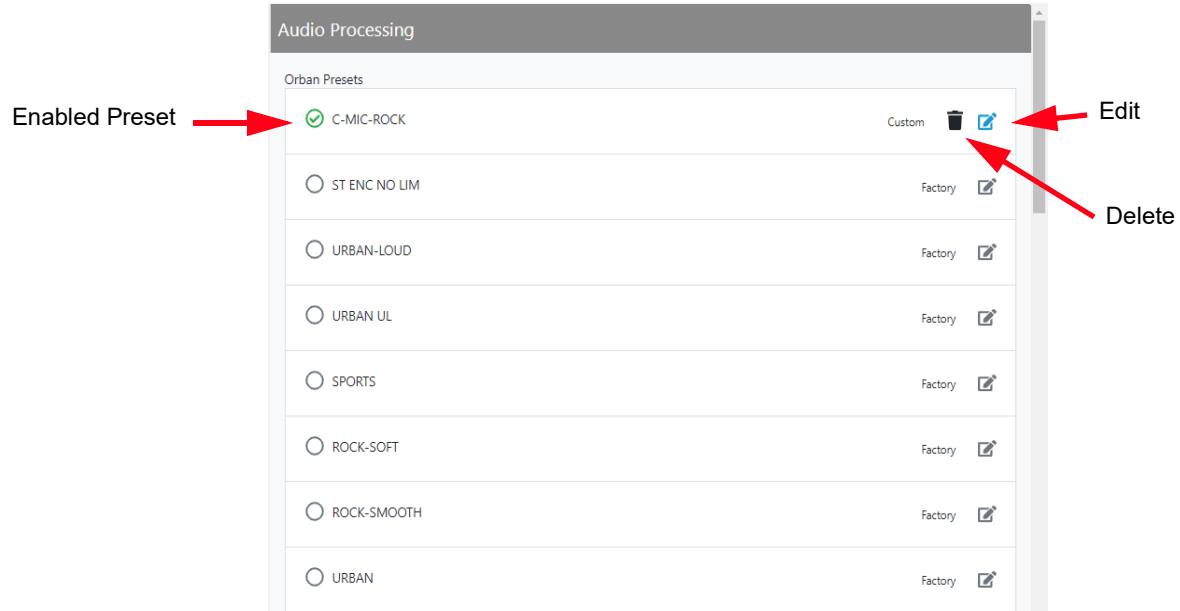

By clicking the Edit button, you can change the various settings for the active preset. See [Figure 3.2.42 on page 3.2.69](#).

The Audio Processing selections include:

Less More, Stereo Enhancer, AGC, EQ, Final Clipping, 2Band, 2Band Distortion, Multiband, Compressors, Bandmix, Multiband Distortion, and UL Distortion. Refer to the Operation section of the Orban Optimod 5500 manual for detailed information on these meters.

To activate any changes in the Audio Processor page, the following options apply:

- for Factory presets - Save As or Cancel
- for Custom presets - Save, Save As and Cancel

When creating a new preset, you must enter a new name in the Save Preset window before clicking the Save As button. Click Cancel to discard changes and return to the Audio Processor page.

NOTE: Selecting an Orban preset locally will cause the remote AUI to also reflect the change. The same occurs on the controller front panel UI when remotely selecting a preset. To create a new Orban Audio Processor Preset, see [Selecting an Orban Audio Processor Preset on page 3.2.198](#).

NOTE: The Audio Processor page contains nine tabbed sections that allow managing of Orban presets. These tabbed pages (see [Figure 3.2.42](#)) illustrate the many parameters associated with an Orban preset. Detailed descriptions are not included in this document. Refer to the Orban Optimod 5500 manual for more information on setting these parameters.

Figure 3.2.42: Audio Processing - Edit

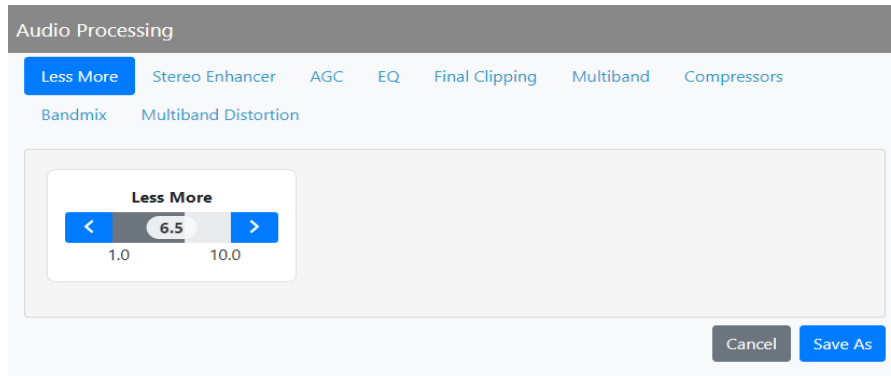

WARNING!

WHEN YOU OPEN THE AUDIO PROCESSOR PAGE WHILE THE TRANSMITTER IS ON AND ORBAN IS ENABLED, THE ACTIVE PRESET IN THE ORBAN AUDIO PROCESSOR IS LOADED BY DEFAULT. LOADING ANOTHER ORBAN PRESET CAUSES THAT PRESET TO BECOME ACTIVE, MAKE SURE YOU UNDERSTAND THE IMPACT THAT A PRESET CHANGE WILL HAVE ON YOUR BROADCAST.

Exciter TCXO

You can calibrate the internal clock reference to an external 10 MHz clock (e.g. GPS synchronized 10 MHz clock) or manually enter an offset value using the remote AUI.

NOTE: You can also adjust the exciter TCXO offset value and run a TCXO calibration from the controller UI (see [Exciter TCXO](#), on page 3.2.175).

NOTE: During calibration, the external 10 MHz clock should be connected to the EXT 10 MHz IN (A1J4B) BNC connector on the rear of the transmitter or to the 10 MHz IN (W2J1) BNC connector on the rear of the optional exciter.

To view the AUI's Exciter TCXO screen (see [Figure 3.2.43](#)), select Exciter TCXO from the Settings menu.

Figure 3.2.43: Settings - Exciter TCXO Calibration

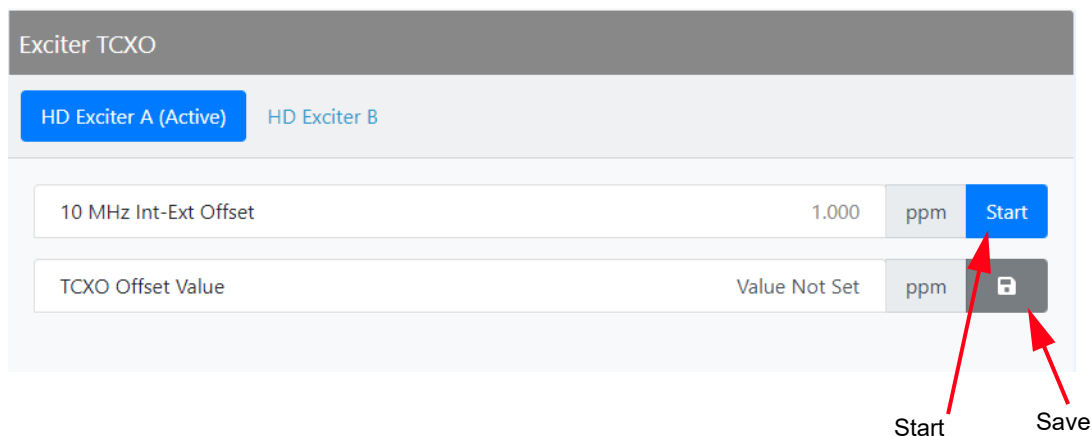

Once this external 10 MHz clock reference is connected, the 10 MHz Int-Ext Offset field will display the difference between the internal and external frequencies (in ppm). Users can press the Start button to automatically calibrate the internal TCXO to the external reference source; equally, they can manually enter the measured internal-external offset value into the TCXO Offset Value field and press Save.

If no external high precision 10 MHz clock reference is connected, but the actual transmitter carrier frequency is being measured with a calibrated external frequency counter, operators can manually offset the internal TCXO by entering the appropriate ppm difference in the 10 MHz Int-Ext Offset. For example, if the frequency of the transmitter is 1 ppm too high, then a positive 1 ppm should be entered in the TCXO Offset Value field in order to compensate. Similarly, if the transmitter frequency is too low, enter a negative ppm value. After an adjustment is made, press Start.

To calibrate another exciter, switch to that exciter and repeat the calibration.

External 10 MHz

You can configure the GV2-10/GV2-7.5 to accept an external 10 MHz input using the AUI or using the controller UI (see [External 10 MHz Input, on page 3.2.158](#)).

NOTE: You can also adjust the exciter TCXO offset value and run a TCXO calibration from the controller UI (see [Exciter TCXO, on page 3.2.175](#)).

This setting allows the user to mask the associated 10 MHz alarm from appearing in the Event History page if it isn't being used. If an external 10 MHz source is being used, an alarm will be activated on the Event History page should the external signal be lost.

NOTE: The exciter will automatically use an external 10 MHz reference signal if connected, no matter the state of this parameter.

To enable the External 10 MHz input on the AUI's External 10 MHz page (see [Figure 3.2.44](#)), slide the External 10 MHz Enable/Disable switch to the right and click Save.

Figure 3.2.44: Settings - External 10 MHz

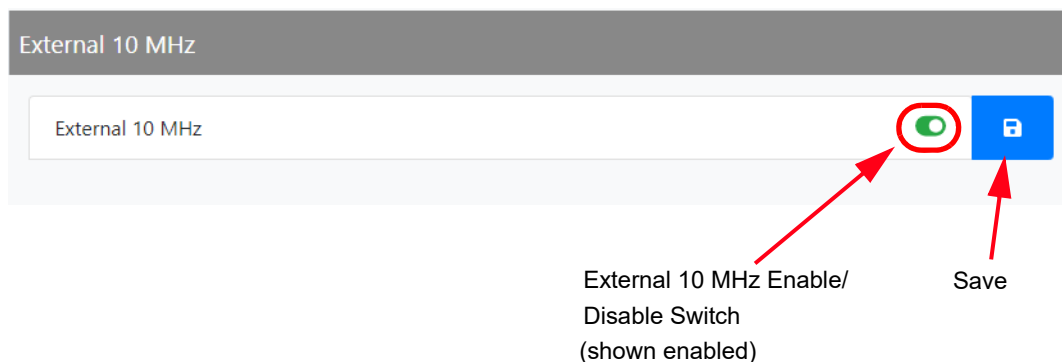

FM Polarity

The FM Polarity page (see [Figure 3.2.45](#)) allows the user to invert the polarity of the frequency modulation (i.e., positive going modulation signal yields positive deviation; or positive going modulation yields negative deviation). Options are Normal or Inverted. Select from the dropdown menu and click the Save button to enable the changes.

Figure 3.2.45: Settings - FM Polarity

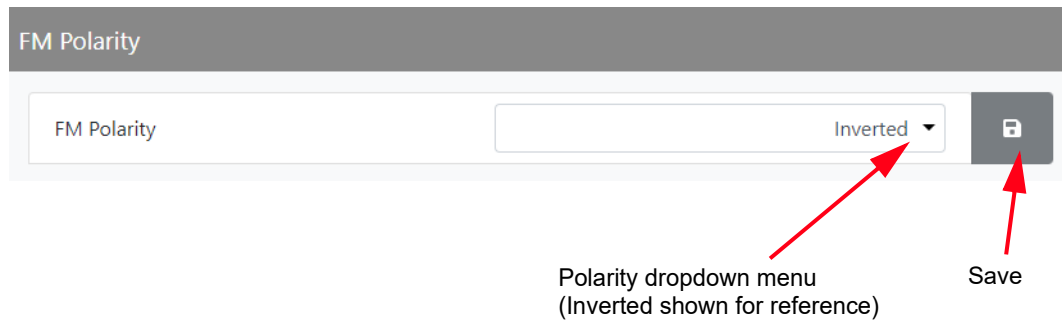

Hardware Configuration





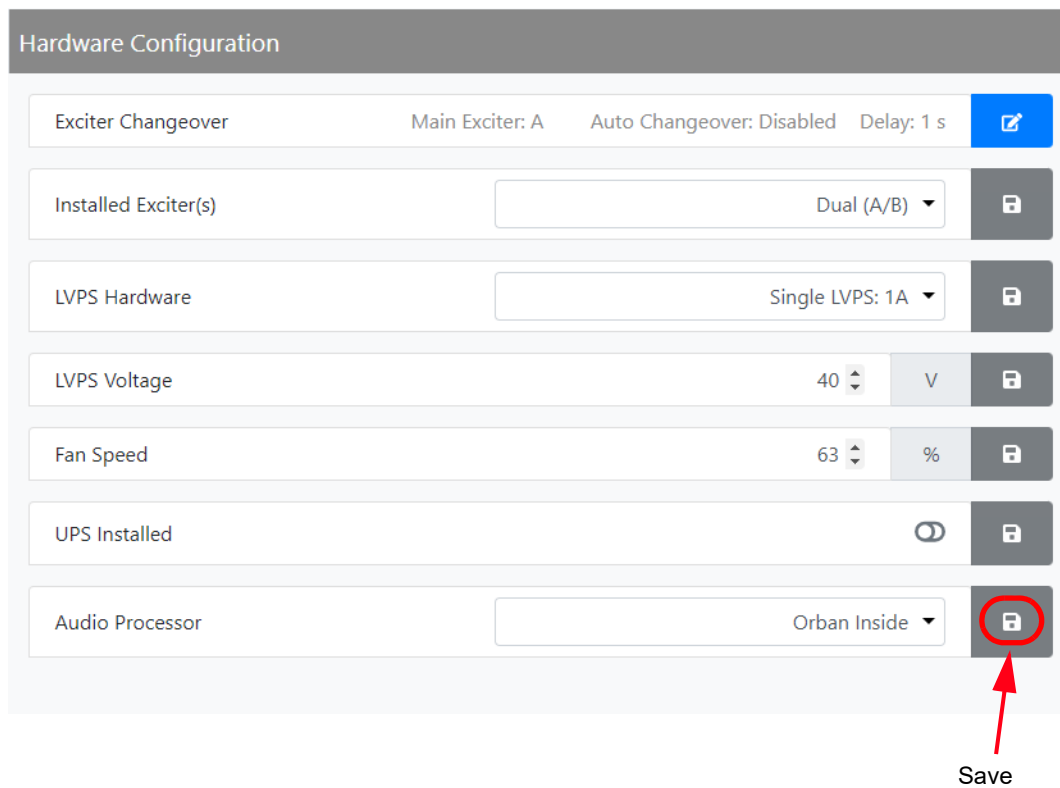

The Hardware Configuration page allows the user to configure the transmitter for any installed hardware that has optional variations (e.g., quantity of exciters or LVPS modules, fan speed) or is non-standard (e.g., UPS or audio processor). See [Figure 3.2.46](#).

NOTE: These settings are established at the factory based on the configuration that existed at time of shipping. Changes to these setting are only necessary if hardware is added or removed by the user.

Figure 3.2.46: Settings - Hardware Configuration



Hardware Configuration

Exciter Changeover	Main Exciter: A	Auto Changeover: Disabled	Delay: 1 s	
Installed Exciter(s)	<input type="text"/>	Dual (A/B)		
LVPS Hardware	<input type="text"/>	Single LVPS: 1A		
LVPS Voltage	40	V		
Fan Speed	63	%		
UPS Installed	<input type="checkbox"/>			
Audio Processor	<input type="text"/>	Orban Inside		

Save

This menu has seven sub-menu options:

- ❖ [Exciter Changeover](#) - see page 3.2.74
- ❖ [Installed Exciter\(s\)](#) - see page 3.2.74
- ❖ [LVPS Hardware](#) - see page 3.2.74
- ❖ [LVPS Voltage](#) - see page 3.2.75
- ❖ [Fan Speed](#) - see page 3.2.75
- ❖ [UPS Installed](#) - see page 3.2.75
- ❖ [Audio Processor](#) - see page 3.2.76

Exciter Changeover

When dual exciters are installed and configured, the user can set the changeover parameters. The parameters are:

- Main Exciter (A or B)
- Auto Changeover (enabled or disabled)
- Delay (in seconds)

Installed Exciter(s)

You can configure the transmitter for the number of installed exciters. If you have upgraded your transmitter to dual exciters, you may have already been prompted to change this configuration. Use the dropdown menu to select the appropriate exciter configuration - Exciter (A) or Dual Exciter (A/B). Press the Save button to save the change.

LVPS Hardware

You can configure the transmitter for the number of installed LVPS modules. If you have upgraded your transmitter to dual LVPS modules, you may have already been prompted to change this configuration.

Use the dropdown menu to select the appropriate LVPS configuration - Single LVPS: A or Dual LVPS: A/B. Press the Save button to save the change.

LVPS Voltage

You can set the default LVPS voltage. The user can set the LVPS voltage to any value between 40 and 53 V, in 0.01 V steps) during normal operation. Under fault conditions, if the LVPS voltage requires an increase, the control system automatically increases the LVPS voltage, then decreases it back to the set value when the fault condition clears. This setting should not require adjustment.

Use the up and down buttons to select a voltage between 40 and 53 V (in 0.01 V steps). The default setting is 48 V. Press the Save button to save the change.

Fan Speed

The transmitter control function automatically adjusts fan speed to ensure adequate cooling based on all operating conditions. As a result this setting should not require adjustment. Increasing the fan speed will allow for cooler transmitter operation, but will also decrease efficiency and increase acoustic noise levels.

You can set the default speed of the transmitter's cooling fans. Under fault conditions, the control system determines if an increase or decrease in fan speed is required and automatically adjusts the fan speed.

Use the up and down buttons to select a value between 63 and 100%. The default setting is 100%, which corresponds to approximately 48 V for the related fan voltage. Press the Save button to save the change.

CAUTION! Reducing Fan Speed will increase operating temperatures for critical components, reducing life expectancy.

NOTE: A 20% reduction in fan speed can yield up to 5 dB improvement in acoustic noise from the transmitter, as well as decrease power consumption (i.e., utility costs) and extend the operating life of the cooling fans.

UPS Installed

You can configure the transmitter for the installation of the UPS interface kit, which allows operation with an external, user-provided UPS. If you have upgraded your transmitter with the UPS interface, you may have already been prompted to change this configuration.

Slide the toggle switch to the right (will turn green) to enable the UPS. Press the Save button to save the change.

Audio Processor

If an Orban Audio Processor is installed, the transmitter must be configured to recognize it.

NOTE: Configuring the Orban audio processor locally will cause the AUI to display an Orban Inside setting. The same occurs on the controller UI when configuring via the AUI.

Use the dropdown menu to select the appropriate configuration - None or Orban Inside. Press the Save button to save the change. Reboot the transmitter by switching the ac power off and then on. This will ensure the transmitter properly detects the Orban Inside card upon recovery.

HD/DRM

NOTE: If HD/DRM is not enabled, it will be greyed out in the Settings menu.

The HD/DRM Settings page allows the user to configure the transmitter for HD operation. The HD/DRM Settings page is divided up into three sub-sections, which are:

- Exgine Settings (see [Exgine Settings](#))
- HD Settings (see [HD Settings on page 3.2.79](#))
- Spectrum Efficiency Optimizer (see [Spectrum Efficiency Optimizer on page 3.2.81](#))

Exgine Settings

The Exgine Settings page allows users to configure the Exgine for HD operation. See [Figure 3.2.47 on page 3.2.78](#). Configure the Exgine Settings as follows:

1. Enable Digital Carriers by sliding the Icon to the right (turns green) and click Save.
2. Select the protocol to be used from the dropdown menu, either UDP or TCP and click the Save. Match this setting to the Exporter configuration.
3. Enter the Exgine IP address and click Save. If no Gateway is used or assigned, enter 0.0.0.0
4. Enter the Exporter IP address and click Save. This is the address of the interface where the data stream is originating. It is used to filter E2X traffic in case multiple Exporters are used in broadcast mode on a single LAN. 0.0.0.0 is also a valid configuration.
5. Enter the Netmask IP address and click Save.
6. Enter the Gateway IP address and click Save.
7. Enter the E2X Port address and click Save. The Exgine expects E2X on port 9000, some non-Nautel users utilize port 11000.
8. Mac Address - displays a number that serves as a unique network adapter identifier. This is set by the manufacturer and is displayed for informational purposes only. It may be necessary to use this number to allow the AUI to access your network.

Figure 3.2.47: Settings - HD/DRM - Engine Settings

HD/DRM

Engine Settings HD Settings Spectrum Efficiency Optimizer

HD Exciter B

Digital Carriers	<input checked="" type="checkbox"/>	
Protocol	UDP	
Engine IP	10.10.10.100	
Exporter IP	10.10.10.101	
Netmask	255.255.255.0	
Gateway	10.10.10.254	
E2X Port	9000	
MAC Address	40:D8:55:01:93:80	

HD Settings

The HD Settings page allows users to establish Forward Tap Delay, FM+HD Low Inj Gain, FM+HD High Inj Gain and HD Gain levels. It also allows for an HD Power Calibration. Changes applied to the active exciter (A or B) only. To calibrate the other exciter, switch to the other exciter and repeat the change. See [Figure 3.2.48 on page 3.2.80](#).

Configure the HD Settings as follows:

- Forward Tap Delay - Displays the time delay (in unit taps) between the forward path signal from the exciter and the reverse path signal into the exciter, fed back from the output of the transmitter. This value is factory set (to synchronize the phase of the forward and reverse signals so that pre-correction can operate properly) and should not require any adjustment in the field. Select the number using the arrow keys and press the Save button.
- Auto-Find Gain - Press the Start button to automatically find the optimized gain while the transmitter is RF On and in the applicable preset mode/injection level. Press the Start button to initiate.
- FM+HD Low Inj Gain - Applicable for FM+HD mode only (at -20 dBc to -15.1 dBc injection levels) and represents the starting/default gain applied to the forward path signal within the exciter at initial turn on/ramp-up. Select the gain using the arrow keys and press the Save button.
- FM+HD High Inj Gain - Applicable for FM+HD mode only (at -15 dBc to -10 dBc injection level) and represents the starting/default gain applied to the forward path signal within the exciter at initial turn on/ramp-up. Select the gain using the arrow keys and press the Save button.
- HD Gain - Applicable for HD mode only and represents the starting/default gain applied to the forward path signal within the exciter at initial turn on/ramp-up. Select the gain using the arrow keys and press the Save button.
- HD Power Calibration - This calibration occurs at the factory and should not require any adjustment in the field. This calibration is performed in FM mode. Press the Save button to initiate.

Figure 3.2.48: Settings - HD/DRM - HD Settings

The screenshot displays the 'HD/DRM' settings page. At the top, there are three tabs: 'Engine Settings', 'HD Settings' (which is selected and highlighted in blue), and 'Spectrum Efficiency Optimizer'. Below the tabs, there is a sub-tab 'HD Exciter B'. The main settings area contains several rows of controls:

- Forward Tap Delay:** A numeric input field with the value '125' and a 'Save' button.
- Auto-Find Gain:** A teal-colored progress bar and a 'Start' button.
- FM+HD Low Inj Gain:** A numeric input field with the value '0.2427' and a 'Save' button.
- FM+HD High Inj Gain:** A numeric input field with the value '0.5091' and a 'Save' button.
- HD Gain:** A numeric input field with the value '1.4145' and a 'Save' button.
- HD Power Calibration:** A numeric input field with the value '4.106014' and a 'Start' button.

Spectrum Efficiency Optimizer

The Spectrum Efficiency Optimizer page allows the user to optimize the transmitter's spectrum and/or efficiency. See [Figure 3.2.49](#). To optimize the HD operation, adjust the following parameters:

- Optimization Enabled - Slide the icon to the right and click Save. Enabling allows the optimizer to adjust the PA voltage setting to maximize efficiency based on the transmitter output spectrum. Depending on other settings in this section, it may require other actions to maintain the transmitter's compliance.
- Desired Mask Delta - Set the desired clearance (between -10 dB and 0 dB) from the spectral mask and click the Save button. The default setting is -1 dB, which will maintain a 1 dB clearance from the mask for maximum efficiency. This settings will not cause any reduction in output power.
- Required Mask Delta - Sets the value (between -10 db and 10 dB) that is considered to be absolutely required. Click the Save button. If this level is exceeded, the digital power from the transmitter will be reduced if the PA voltage is at maximum. If the spectral mask still cannot be met and the setting for it is enabled, the transmitter power set-point will be reduced.
- Reduce Digital Power If Required: Slide the icon to the right and click Save. Enabling allows a reduction in injection level (digital power) if the spectrum mask requires it.
- Reduce Power Set-Point If Required: Slide the icon to the right and click Save. Enabling allows a reduction in the transmitter power set-point if the spectrum mask requires it.

Figure 3.2.49: Settings - HD/DRM - Spectrum Efficiency Optimizer

The screenshot shows the 'Spectrum Efficiency Optimizer' settings page. At the top, there are three tabs: 'Exgine Settings', 'HD Settings', and 'Spectrum Efficiency Optimizer'. Below the tabs, there are five settings rows, each with a label, a value field, a unit, and a save button:

Setting	Value	Unit	Save Button
Optimization Enabled	<input checked="" type="checkbox"/>		Save
Desired Mask Delta	-1	db	Save
Required Mask Delta	0	db	Save
Reduce Digital Power If Required	<input checked="" type="checkbox"/>		Save
Reduce Power Set-Point If Required	<input type="checkbox"/>		Save

Network

CAUTION!

When connecting to a Nautel transmitter, we support both HTTP and HTTPS protocols. If using HTTP, the data traffic is not encrypted, meaning your username/password could be compromised. For security reasons, Nautel recommends using HTTPS whenever possible.

You can configure network settings using the remote AUI (see [Figure 3.2.50](#)). If you change a network setting on the controller UI, it will also be reflected on the remote AUI, and vice versa.

NOTE: Nautel recommends that network settings be entered/vetted by a qualified Network Administrator. If parameters are changed and the AUI is reset, record the new values (or see the local controller UI) to ensure you can log in after changes are made.

Figure 3.2.50: Settings - Network

The screenshot shows a web interface for configuring network settings. The title is "Network". Under the "General" section, there is a table of settings:

Field	Value
Mac Address	70:B3:D5:87:C2:FB
DHCP	<input checked="" type="checkbox"/>
IP Address*	192.168.0.99
Subnet Mask*	255.255.255.0
Gateway*	192.168.0.1
Status	Running

Under the "DNS Servers" section, there is another table:

Field	Value
DNS 1*	24.222.0.94
DNS 2*	24.222.0.95

At the bottom right of the form are "Cancel" and "Save" buttons.

All IP addresses shown are for reference purposes only

Determining DHCP Setting

One of the main decisions in configuring the network connection on your GV2-10/GV2-7.5 transmitter is whether you set DHCP to ON or OFF. If you are connecting to a network, consult with a network administrator before connecting the transmitter to your network to determine whether to enable (turn ON) or disable (turn OFF) the DHCP setting.

NOTE: DHCP can only be set from on/off from the controller front panel UI.

When DHCP is set to ON (default from factory), IP addresses are assigned automatically by the network server. In order for this feature to function properly, you must have a network-viewable DHCP server on your network.

If a DHCP server is not present, you (or your network administrator) must provide static addresses for IP, netmask, gateway and nameservers (gateway and nameservers are optional). You must enter them manually using the transmitter's controller front panel. In this case, DHCP should be set to OFF.

NOTE: A nameserver: (also called a DNS) translates a host name (e.g., mail.nautel.com) to an IP address such as in configuring email (see [Network on page 3.2.82](#) and [Email Server on page 3.2.86](#)).

Network Setup - Using the AUI

NOTE: The following settings should be entered/vetted by a qualified Network Administrator.

By entering the GV2-10/GV2-7.5's established IP address into an Internet browser's address bar, and then logging into the AUI, you can view and edit the network parameters (see [Figure 3.2.50 on page 3.2.82](#)). You must have remote control enabled to edit network settings using the remote AUI. The MAC Address and Status fields are read-only; they cannot be edited. You must disable DHCP (as shown in [Figure 3.2.50 on page 3.2.82](#)) to be able to edit the IP Address, Subnet Mask and Gateway fields. If DHCP is enabled, these fields will be assigned automatically. The DNS1 and DNS2 nameserver fields can be edited regardless of the DHCP setting.

The Status field identifies the status of the network.

- ❖ **RUNNING:** transmitter is connected to a network and is functioning properly.
- ❖ **NOT RUNNING:** transmitter is not connected or is not functioning properly. When in this state, remote AUI access is not possible.

Notifications

The Notifications feature (see [Figure 3.2.51](#)) provides a means for the transmitter to issue emails or texts (SMS messages) triggered by user defined alarm events. If you use this feature, you must also configure an email (see [Email Server on page 3.2.86](#)).

Figure 3.2.51: Settings - Notifications

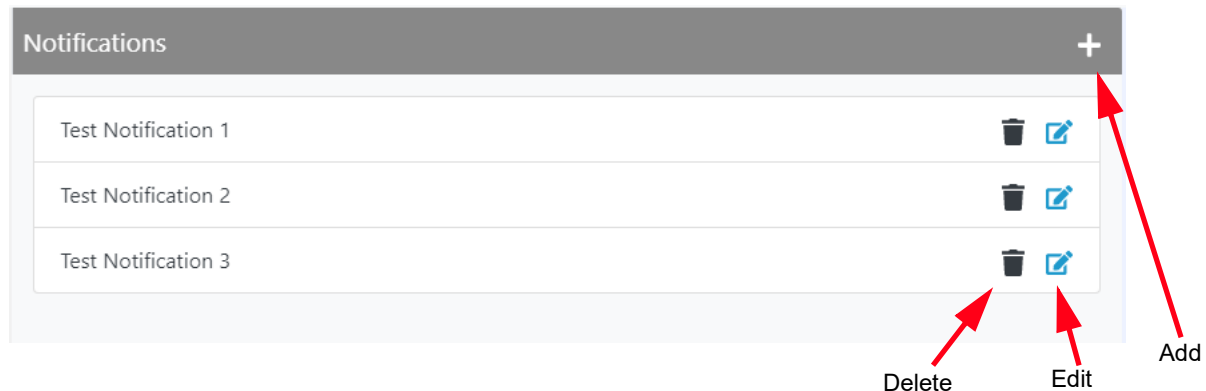

To configure the notifications feature, perform the following steps:

1. Pre-existing notifications are displayed in the Notifications list (e.g., "Audio Loss"). Click Add to create a new item for notification, click Edit (after highlighting an existing item) to edit an existing item or click Delete to erase an item.
2. When you click Add or Edit, the screen in [Figure 3.2.52 on page 3.2.85](#) will appear. This screen allows you to add or edit a Notification Name, Recipient Email(s) (use a semi-colon to separate multiple email addresses, as applicable), and define the alarm list by Device type. Add or remove alarms by moving them (using the > and < arrow buttons) from the Available Alarms list to the Selected Alarms list. An email is issued when any alarm in the Selected Alarms list is active.

Text (SMS) Messaging: In the Recipient Email field, you can enter a standard email address to initiate an email or you can enter a mobile phone number and SMS gateway to initiate a text (SMS message). The email-to-SMS text format is `mobilenumber@mobile_gateway` (e.g., `5551234567@txt.bell.ca`). Check with your mobile carrier to determine the proper gateway address for your area.

3. When complete click the Send Test Notification button to send a test email to the associated email address. Click Save to accept changes or the Cancel button to discard changes and return to the Notifications page.

Figure 3.2.52: Notifications/Email Server Configuration Page

Notifications +

External Interlock [trash] [edit]

Email Server Configuration ⓘ

General

Host*	smtp.gmail.com
Port*	465
Transmitter Name*	VS300
Sender Email*	
Authentication	<input checked="" type="checkbox"/>
Username*	
Password* <input type="checkbox"/> Show Password

Cancel Save

Send Test Email

Recipient Enter Email

Send Test Email

Authentication enabled for reference purposes only

All IP addresses shown are for reference purposes only

Email Server

Email Server (see [Figure 3.2.52 on page 3.2.85](#)) allows you to configure email parameters (e.g., email server and port number), and is required if the notification feature is used.

NOTE: Nautel recommends that the following settings be entered/vetted by a qualified Network Administrator.

From the Notifications menu, the Email Server fields must be completed to configure the email feature. Perform the following steps (see [Figure 3.2.52 on page 3.2.85](#)):

Enter the following five parameter fields:

- ❖ **Host:** In order to enter a server name (e.g., mail.nautel.com), at least one nameserver IP address must be entered.
- ❖ **Port Number:** This logical connection end point uses a number to identify the type of process to which an internet or other network message is to be forwarded to when it arrives at a server. Typically, this is set to 25 for unencrypted SMTP systems and 843 for encrypted email.
- ❖ **Transmitter Name:** Set to a name that associates to the transmitter such as station identification (e.g., VS_WXYZ). This name will be included in notification emails.
- ❖ **Sender Email Address:** Enter as a standard email address (e.g., a@b.com). This will be the sender address that notification email recipients will see. Free web based email service accounts (Gmail, Hotmail, Yahoo mail etc.) are acceptable here.
- ❖ **Authentication:** If your email server requires authentication to send emails, click the check box and enter the appropriate Username and Password to allow this. If the check box is not selected, the Username and Password fields do not appear.

NOTE: The transmitter will automatically handle encryption if the associated mail server requires it.

When complete click Save to store these settings. Enter a recipient email address in the Send Test Email section and click the Send Test Email button to test your settings. Click the Save button to run the test or the Cancel button to return to the Notifications page.

Reboot Options

The Reboot Options page allows users to select the reboot various devices throughout the transmitter. See [Figure 3.2.53](#).

There are three reboot options to choose from:

- ❖ Reboot Host (SBC)
- ❖ Reboot Active Exciter
- ❖ Reboot Standby Exciter

Click the desired option to initiate a reboot of that device.

A Reboot Host allows the user to force a host (SBC) reset to the AUI.

Rebooting the Active Exciter will cause a brief interruption in transmitter operation. Rebooting the Standby Exciter is only applicable for dual exciter systems.

NOTE: For a Host Reset, all users that are remotely connected (logged in) will be disconnected (logged out).

Figure 3.2.53: Settings - Reboot Options

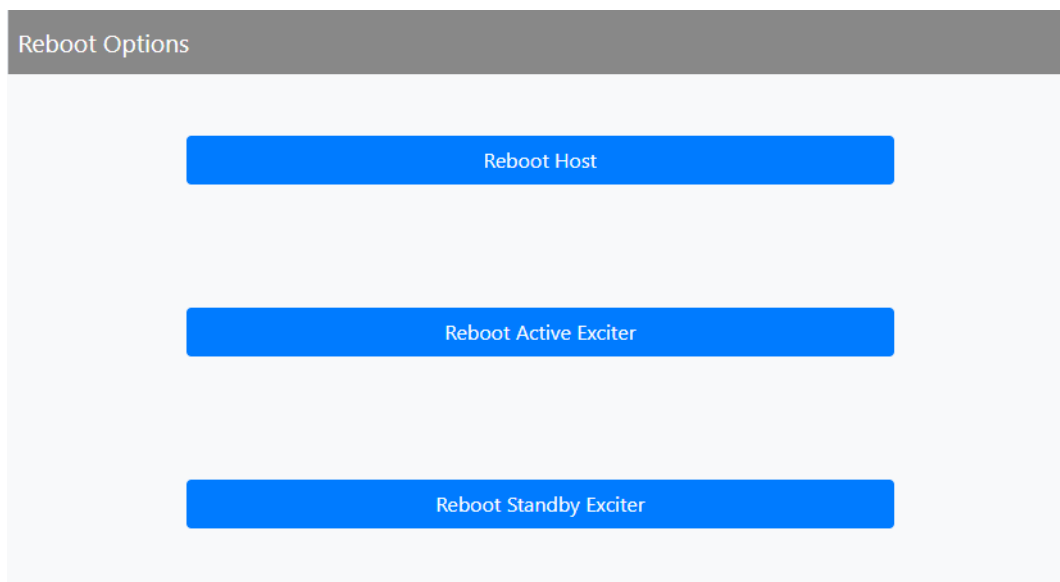

Screen Configuration (Local AUI only)

The Screen Configuration page allows users to enable a Screen Saver for the front panel display and perform a touchscreen calibration.

Refer to [Non-standard maintenance - see page 3.4.1](#) for detailed information on these features.

Security Certificates

The AUI supports HTTPS connections and to take advantage of this, the user must either use a free or purchased Security Certificate.

Security uses public and private keys to ensure that the site is verified that is what it purports to be and therefore safe.

For most users there is no need to add a Security Certificate, as the connection to the transmitter is controlled by the customer's network architecture, however, it is available for organizations that wish to take extra precautions.

Security Certificates are uploaded to the transmitter via the Settings > Security Certificates menu.

Purchased certificates are provided by Certificate Authorities:

https://en.wikipedia.org/wiki/Certificate_authority

Click the Browse button to search for the certificate and press Upload to activate. See [Figure 3.2.54](#).

Figure 3.2.54: Settings - Security Certificates

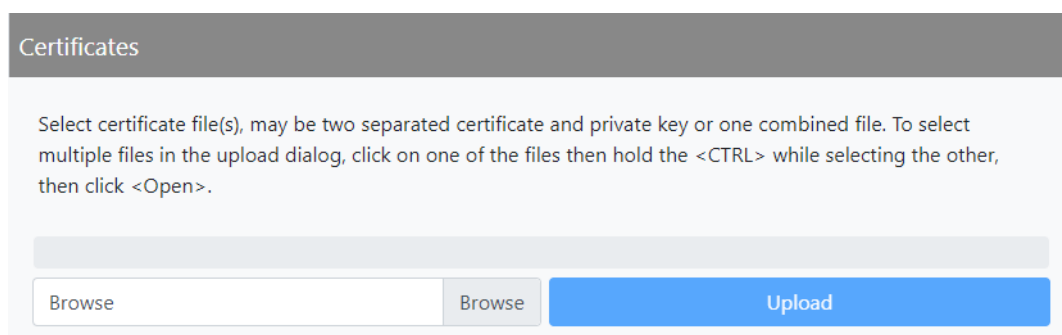

Certificates

Select certificate file(s), may be two separated certificate and private key or one combined file. To select multiple files in the upload dialog, click on one of the files then hold the <CTRL> while selecting the other, then click <Open>.

Browse Browse Upload

SNMP

The SNMP configuration page provides a user with a means to configure the SNMP agent and the associated traps (see [Figure 3.2.55](#)).

Figure 3.2.55: Settings - SNMP

The screenshot displays the SNMP configuration interface. At the top, the title "SNMP" is shown. Below it, the "General" section contains the following fields:

- SNMP Version:** A dropdown menu set to "v2C".
- Agent Port*:** A text field containing "161".
- Read Community String:** A section with two input fields labeled "New String" and "New String (Confirm)", a "Show String" checkbox, an "Add" button, and a password mask icon.
- Write Community String:** A section with two input fields labeled "New String" and "New String (Confirm)", a "Show String" checkbox, an "Add" button, and a password mask icon.
- Enable Traps:** A toggle switch that is currently turned on (green).
- Available Trap Settings:** A dropdown menu showing "SNMP Trap Settings" and "No SNMP Trap Settings".
- Selected Trap Settings:** A dropdown menu showing "SNMP Trap Settings" and "TRAP to 127.0.0.1:162".

Between the Available and Selected Trap Settings sections, there are navigation icons: a right-pointing arrow, a left-pointing arrow, an edit icon, a delete icon, and a plus sign.

At the bottom of the configuration area, there is a note: "Traps enabled for reference purposes only". To the right of this note are "Cancel" and "Save" buttons.

Configure the SNMP agent as follows:

1. Enter the first five fields, noting the following:
 - ❖ Agent Port: Enter the UDP port where the SNMP agent checks for requests. The default setting is 161. If your transmitter is behind a firewall, you must open this port to use SNMP.
 - ❖ Read Community String: Enter the password for the SNMP client application to allow acquisition of channel values. Provide confirmation of this password by re-entering it in the Confirm field.
 - ❖ Write Community String: Enter the password for the SNMP client application to allow changing of channel values. Provide confirmation of this password by re-entering it in the Confirm field.
2. Select Enable Traps to allow the SNMP agent to send trap notifications, and to display two additional fields associated with traps. Enter the two additional fields as follows:
 - ❖ Trap Receiver IP: Enter the IP address of the computer to which the SNMP agent will send trap notifications. The computer must be running an SNMP application that is configured to receive traps. The SNMP agent will send trap notifications to only one recipient.
 - ❖ Trap Receiver Port: Enter the UDP port where the SNMP agent will send traps. The default setting is 162.
3. When complete press Save or press the Cancel to restore the previous settings.

NOTE: Check the Read Community and Write Community passwords after a software upgrade. Some upgrades will clear passwords and require them to be reset.

Spectrum Mask

The Spectrum Mask page allows users to select the appropriate FM mask standard being used by the Dashboard spectrum analyzer. See [Figure 3.2.56](#). Use the Mask Type dropdown menu to select the desired mask (factory setting is FCC). Press the Save button to enable the mask.

There are three mask options to choose from:

- ❖ FCC
- ❖ ETSI
- ❖ None

NOTE: Selecting the spectrum mask standard applies only to FM mode of operation. For other modes of operation (e.g., FM+HD, HD, DRM), the spectrum mask is automatically applied.

Figure 3.2.56: Settings - Spectrum Mask

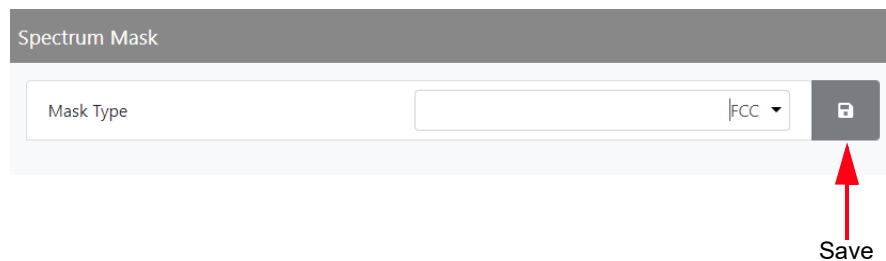

System Preferences

The System Preferences page allows the user to display the Temperature units in either Celsius or Fahrenheit. See [Figure 3.2.57](#).

Select from the drop-down menu and click the Save icon to save the changes.

Figure 3.2.57: Settings - System Preferences

System Preferences

Temperature Units Display	Fahrenheit	Save
Turn-On Delay	0 s	Save
Ramp-Up Speed	100 %	Save

Save

NOTE: Temperature units selection (e.g. Celsius or Fahrenheit) will be the same for all login sessions or multiple users. If the units are changed in one login session, they will be changed for all open sessions and all users.

Thresholds

You can set thresholds for the main audio and SCA sources (trip level and timeout) using the remote AUI. These thresholds determine the limit for an associated low audio power alarm to be activated.

If you change a setting on the remote AUI, it will also change on the controller front panel UI, and vice versa.

Audio Low Thresholds

The AUI's Audio Low Thresholds page (see [Figure 3.2.58](#)) displays a screen that allows for setting of the low trip level and timeout delay for the main audio and SCA audio low thresholds.

If the applicable audio source (main or SCA) level falls below the Trip Level setting (default is -22.5 dB) for longer than the Timeout setting (default is 20 s), an alarm will activate in the Alarms page.

When the audio source level increases above the Trip Level, the alarm will clear. To disable the low audio alarm, set the associated Trip Level to -100 dB. Press Save button to save the change.

Use the up and down arrows to change the Trip Level or Timeout and click the Save button.

Figure 3.2.58: Settings - Thresholds - Audio Low

The screenshot shows a web interface for setting audio low thresholds. At the top, there is a header 'Thresholds' and a sub-header 'Audio Low' with a secondary label 'Low Forward Power'. Below this, there are four rows of settings, each with a text input field, a numeric value, a unit, and a 'Save' button. A red arrow points to the 'Save' button for the 'SCA Audio Low Trip Level' setting.

Setting	Value	Unit	Action
Main Audio Low Timeout	23	s	Save
Main Audio Low Trip Level	-21	dB	Save
SCA Audio Low Timeout	20	s	Save
SCA Audio Low Trip Level	-22.5	dB	Save

Low Forward Power Thresholds

Use the up and down buttons to move the cursor to the desired line item and click the Save icon to save the changes. Select a threshold between 0 and 100% (in 0.5% increments), that corresponds to a percentage of rated power. See [Figure 3.2.59](#).

The default setting for Low Forward Power is 50% (equivalent to 3 dB power reduction).
The default setting for Very Low Forward Power is 12.5% (equivalent to 9 dB power reduction).

Figure 3.2.59: Settings - Thresholds - Low Forward Power

Thresholds			
Audio Low	Low Forward Power		
Low Forward Power	50	%	Save
Very Low Forward Power	12.5	%	Save

Time

The GV2-10/GV2-7.5's internal clock uses a backup battery, and therefore maintains an accurate date and time, even during power outages. The date and time needs to be set when the transmitter is first installed, or after a power outage if the backup battery has failed.

If the NTP feature is enabled (see [Figure 3.2.60](#)), the clock will set automatically and cannot be manually adjusted.

You can set the date and time using the remote AUI (see [Setting the Clock - Using the AUI](#)). If you change the clock setting on the controller front panel UI, it will also be reflected on the remote AUI, and vice versa.

Setting the Clock - Using the AUI

You can remotely set the GV2-10/GV2-7.5's time and date by selecting Time from the Settings menu. See [Figure 3.2.60](#).

Figure 3.2.60: Settings - Time

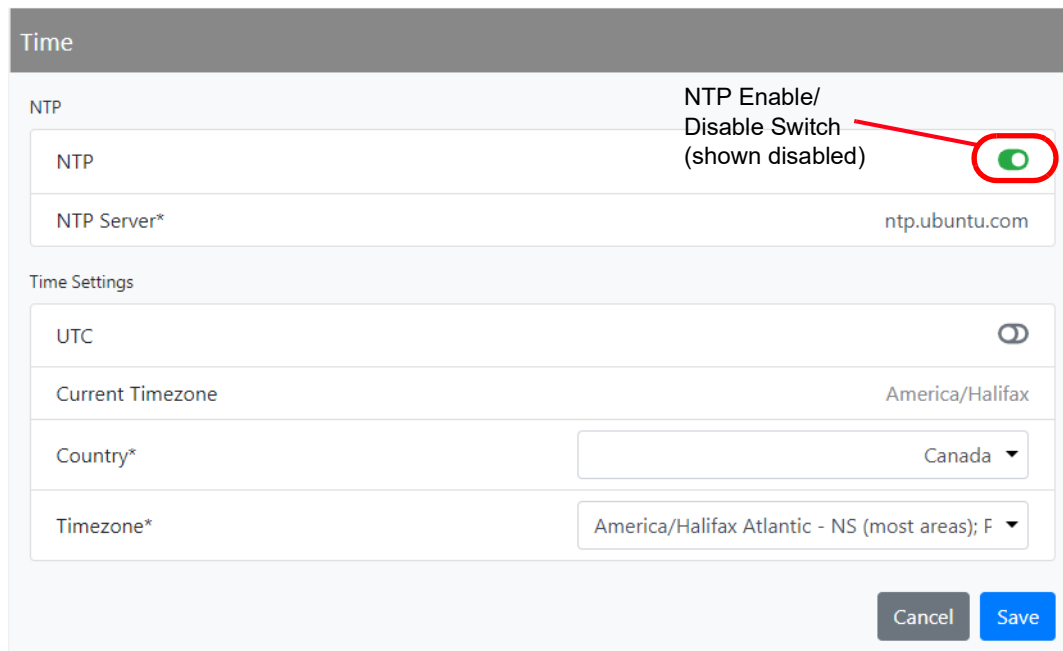

The screenshot shows the 'Time' settings page. It is divided into two sections: 'NTP' and 'Time Settings'. In the 'NTP' section, there is a toggle switch labeled 'NTP Enable/Disable Switch (shown disabled)' which is currently turned on (green). A red circle highlights the toggle, and a red arrow points to it from the right. Below this is a text field for 'NTP Server*' containing 'ntp.ubuntu.com'. The 'Time Settings' section includes a 'UTC' toggle (off), a 'Current Timezone' dropdown set to 'America/Halifax', a 'Country*' dropdown set to 'Canada', and a 'Timezone*' dropdown set to 'America/Halifax Atlantic - NS (most areas); F'. At the bottom right are 'Cancel' and 'Save' buttons.

The Time option allows users to set the exact time and date information as well as regional and timezone settings for a transmitter location.

Procedure to set up the time and date:

1. Select the Time option from the Settings page.
2. Enter the following location parameters:
 - ❖ Country - select the appropriate country from the drop-down menu.
 - ❖ Timezone - select the appropriate timezone based on Country selection.
3. Enter Time and Date parameters and press Save. Press Cancel to discard changes. Please note that Time and Date cannot be set via this menu if NTP is enabled (see [Figure 3.2.60 on page 3.2.95](#)).
 - ❖ Date - select values from the calendar icon for Day, Month, and Year.
 - ❖ Time - select values from the clock icon for hours (24-hour clock) and minutes (up to 60). You can click Now to set the clock to the current time.

NOTE: Changes cannot be made via this menu if NTP is enabled. Disable NTP, make the required changes in the Time menu, then re-enable NTP.

NOTE: Ensure the proper Timezone is selected to observe Daylight Savings time (DST).

NTP servers

You can configure an NTP (Network Time Protocol) server to allow clock synchronization with all computers on the same network as the transmitter.

NOTE: The accuracy of the NTP synchronization is related to the distance to the server, therefore Nautel recommends you choose servers in the same country as the equipment. If this is not possible, attempt to connect to servers from the same continent.

NOTE: The NTP clock synchronization polling interval varies between 64 and 1024 seconds. To minimize network traffic, the interval will change depending on how much error is accumulated between polling events and will be increased if the remote NTP server becomes unreachable. The polling interval is also randomized slightly to avoid the situation where a large number of requests are always arriving at the NTP server at the same time.

Enabling NTP

Enable the NTP function by moving the NTP toggle switch to the right (displays green). Disable by moving the NTP toggle switch to the left. When NTP is disabled, the Current Timezone fields (Country and Zone, as applicable) are also displayed (see [Setting the Clock - Using the AUJ](#)). Click the Save button to activate any change.

Transmitter Info

NOTE: Nautel recommends adding a Transmitter Name and Serial Number to the Transmitter Info section. This will provide easy transmitter identification when using the remote AUI.

The Transmitter Info page allows the user with a means to name the transmitter as a simple identifier. See [Figure 3.2.61](#). Enter the information to be used as follows (Transmitter Name, Serial Number).

Click the Transmitter Name or Serial Number bar to enter a new name or serial number or edit a previous one and press the Save button to save the changes.

Figure 3.2.61: Settings - Transmitter Info

Transmitter Info	
Transmitter Model	VS300
MAC Address	70:B3:D5:87:C2:FB
Transmitter Unique ID (GUID)	
Transmitter Name	C-MIC - VS300
Serial Number	10006713

Save

Users

NOTE: This function is only available via remote connection to the AUI.

The Users menu (see [Figure 3.2.62](#)) allows a user with the proper permissions to create accounts to allow certain users to access and control features of the AUI, and receive notifications when critical-level or maintenance-level alarms occur. To view this menu, select Users from the Settings menu.

NOTE: Depending on the permission level assigned to a given user, some features shown in [Figure 3.2.63](#) on page 3.2.100 may not be displayed or available.

The GV2-10/GV2-7.5 contains two default user accounts when it leaves the factory. (Administrator and Viewer). See [AUI Pages on page 3.2.15](#)).

The Administrator default Username is "Admin" and password is "change_me". The Viewer default Username is "Viewer" and the password is blank (i.e., no password).

The Administrator account is able to perform all user functions, whereas the Viewer account only has visibility of the user functions.

Figure 3.2.62: Settings - Users

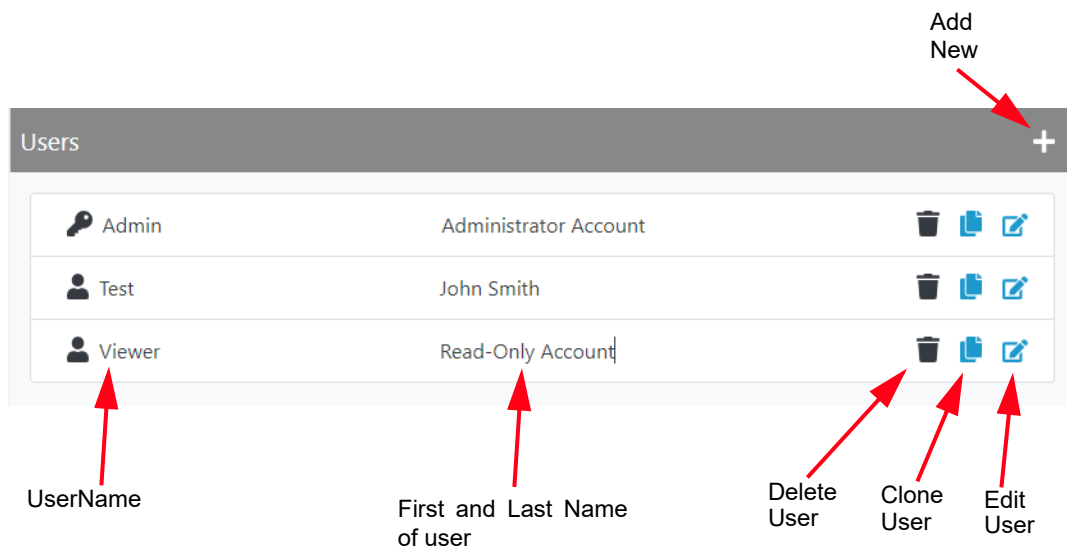

Setting Permissions

There are three user permissions, each with their own specific functionality. See [Figure 3.2.63 on page 3.2.100](#). All users have permission to change their own name, email, language and password, after their account has been created, but are otherwise limited to the following functions:

- **Edit Presets:** Pre-defined user type. Allows the user to modify presets and change active preset. No administrative functions.
- **RF Control:** Pre-defined user type. Allows the user to turn the RF output on and off. No administrative functions.
- **Administrator:** Pre-defined user type. Can perform all functions. Administrator is the only permission level that allows addition, deletion or editing of users.

Click Save to activate the changes.

Adding/Editing Account Information

If the Permission user role is Administrator, you have permissions to edit any user account. Other roles are limited.

Add an Account

To add a user account, click the + symbol in [Figure 3.2.62 on page 3.2.98](#). Enter the User Form (see [Figure 3.2.63 on page 3.2.100](#)) with user account information, including First Name, Last Name, Email, Language and Permissions. Click Save to accept. See also [Set or Change the Password on page 3.2.100](#).

Edit an Account

To edit an existing user account, click the Edit User icon of the desired user in the Users list (see [Figure 3.2.63 on page 3.2.100](#)). The User Form for that user will be displayed. You can edit the Name, Email, Language, Permissions and Password (see [Set or Change the Password on page 3.2.100](#)). Click Save to accept.

Figure 3.2.63: User Form Page

The screenshot displays a 'User' form with two main sections: 'Information' and 'Permissions'. The 'Information' section contains fields for User Name (Admin), First Name (Administrator), Last Name (Account), Email, and Language (English). The 'Permissions' section includes checkboxes for Edit Presets, RF Control, and Administrator, with the Administrator checkbox checked. At the bottom, there are buttons for 'Change Password', 'Cancel', and 'Save'.

Information	
User Name	Admin
First Name	Administrator
Last Name	Account
Email	
Language	English

Permissions	
Edit Presets	<input type="checkbox"/>
RF Control	<input type="checkbox"/>
Administrator	<input checked="" type="checkbox"/>

Buttons: Change Password, Cancel, Save

Set or Change the Password

To set or change your password, click Change Password at the bottom, left of the User Form screen. A menu appears (see [Figure 3.2.64 on page 3.2.101](#)) that prompts you to enter the old password (as applicable), new password and confirmation of the new password. Click the OK button to accept changes or the Cancel button to discard changes and exit this menu.

Figure 3.2.64: Changing Password

Change Password ✕

Old Password

New Password

New Password (Confirm)

Cancel Save

Delete an Account

To delete a user account, click the Delete User icon of the desired user in the Users list (see [Figure 3.2.62 on page 3.2.98](#)). Click Continue in the confirmation window to delete the user account or click Close to keep the user account and return to the Users list.

Remote I/O

The Remote I/O page allows the user to configure the remote input/output interface for the transmitter. Refer also to the GV2-10/GV2-7.5 Installation Manual for information on remote inputs and outputs and their factory default settings.

- Digital Inputs (see [Digital Inputs](#))
- Digital Outputs (see [Digital Outputs on page 3.2.105](#))
- Analog Outputs (see [Remote I/O Settings on page 3.2.190](#))

Digital Inputs

Using the Digital Inputs page (see [Figure 3.2.65](#)), you can configure up to seven inputs that allow you to remotely control various operational characteristics of the transmitter. Unless otherwise noted, these inputs are only accepted by the transmitter if remote control has been enabled. That setting can only be made by a local user using the controller front panel UI's REMOTE button (its LED is green when remote is enabled). Nautel sets remote input defaults prior to shipping. See the Installation Manual for details.

Figure 3.2.65: Remote I/O - Digital Inputs Page

#	Name	Channel	Control	Level	Edit
1	Input 1	RF On/Off	Rising Edge, Activate	1	
2	Input 2	RF On/Off	Rising Edge, Deactivate	1	
3	Input 3	Preset 1 Active	Rising Edge, Set	1	
4	Input 4	Unassigned	Unassigned	1	
5	Input 5	RF Power Adjust	Rising Edge, Increase	1	
6	Input 6	RF Power Adjust	Rising Edge, Decrease	1	
7	Input 7	Alarm Reset	Rising Edge, Reset	1	

The current settings for Input 1 through Input 7 are displayed, including the Channel and Control settings, as well as the current logic Level (1 or 0). You can edit Channel and Control settings by clicking the edit icon for the desired input. This displays the menu in [Figure 3.2.66 on page 3.2.103](#).

Figure 3.2.66: Input Editing Menu

Remote Input 1

Channel	RF On/Off
Control	Rising Edge, Activate
Level	1

Cancel Save

SELECT INPUT CHANNEL

From the editing screen for remote input 1 through 7, you can configure the input for one of a variety of channel inputs. Click the Channel field's up/down arrows to display the following options:

- ❖ Unassigned. No effect on transmitter operation, regardless of logic level.
- ❖ RF On/Off. Same as pressing the RF On (telling the system to provide RF power, if possible) or the RF Off button on the FPUI. There are two inputs configured by default; one for Falling Edge, Activate and one for Falling Edge, Deactivate.
- ❖ Preset 1 Active: Selects preset 1 as active.
- ❖ Preset 2 Active: Selects preset 2 as active.
- ❖ RF Power Adjust. Activating these inputs will increment/decrement the current preset power level by 1% of the rated power. Holding the selection will increment/decrement the power level by 1% every 1/2 second. There are two inputs configured by default; one for Falling Edge, Increase and one for Falling Edge, Decrease. **NOTE:** If multiple power increase or decrease inputs are active, the lower number input takes precedence.
- ❖ Alarm Reset. Initiates an reset for latched alarms. Same as initiating an Alarms Reset from the controller front panel's main menu.

Click Save to activate changes. Click Cancel to cancel changes and return to the Remote Inputs screen. If you save a change to a remote input via the AUI, it will also be displayed on the controller front panel UI.

CONFIGURE INPUT CONTROL LOGIC

From the editing screen for remote input 1 through 7, you can configure the input's active/inactive control logic. Click the Control field's up/down arrows to display the following options, noting the options differs for each Channel input:







Channel	Control options	Description
Unassigned	Unassigned	No logic setting.
RF On/Off	Rising Edge, Activate	Logic '1' (high or rising edge) activates the input.
	Falling Edge, Activate	Logic '0' (low or trailing edge) activates the input.
	Rising Edge, Deactivate	Logic '1' (high or rising edge) de-activates the input.
	Falling Edge, Deactivate	Logic '0' (low or trailing edge) de-activates the input.
	Rising Edge, Toggle	Logic '1' (high or rising edge) activates the input; next logic '1' (high or rising edge) de-activates the input.
	Falling Edge, Toggle	Logic '0' (low or trailing edge) de-activates the input; next logic '0' (low or trailing edge) activates the input.
	Active High, Turn On. Active Low, Turn Off.	Logic '1' (high) causes an RF on. Logic '0' (low) causes an RF off.
	Active High, Turn Off. Active Low, Turn On.	Logic '1' (high) causes an RF off. Logic '0' (low) causes an RF on.
Preset 1/2 Active	Rising Edge, Set	Logic '1' (high or rising edge) selects the preset.
	Falling Edge, Set	Logic '0' (low or trailing edge) selects the preset.
	Active High, Activate	Logic '1' (high) activates the preset.
	Active Low, Activate	Logic '0' (low) activates the preset.
RF Power Adjust	Rising Edge, Increase	Logic '1' (high or rising edge) causes a power increase.
	Falling Edge, Increase	Logic '0' (low or trailing edge) causes a power increase.
	Rising Edge, Decrease	Logic '1' (high or rising edge) causes a power decrease.
	Falling Edge, Decrease	Logic '0' (low or trailing edge) causes a power decrease.
	Active High, Increase	Logic '1' (high) causes a power increase.
	Active Low, Increase	Logic '0' (low) causes a power increase.
	Active High, Decrease	Logic '1' (high) causes a power decrease.
	Active Low, Decrease	Logic '0' (low) causes a power decrease.
Alarm Reset	Rising Edge, Reset	Logic '1' (high or rising edge) causes a reset.
	Falling Edge, Reset	Logic '0' (low or trailing edge) causes a reset.

Click Save to activate changes. Click Cancel to cancel changes and return to the Remote Inputs screen.

Digital Outputs

Using the Digital Outputs page (see [Figure 3.2.67](#)), you can configure up to six outputs that indicate either the presence of various alarms or the status of operator controlled circuits. Nautel sets remote output defaults prior to shipping. See the Installation Manual for details.

Figure 3.2.67: Remote I/O - Digital Outputs Page

Digital Outputs					
#	Name	Channel	Control	Level	Edit
1	Output 1	RF On/Off	Active Low	1	
2	Output 2	RF Output Fault	Active Low	1	
3	Output 3	Preset 1 Active	Active Low	0	
4	Output 4	Unassigned	Unassigned	1	
5	Output 5	Remote Status	Active Low	0	
6	Output 6	Overall Summary Alarm	Active Low	1	

The current settings for Output 1 through Output 6 are displayed, including the Channel and Control settings, as well as the current logic Level (1 or 0). You can edit Channel and Control settings by clicking the edit icon for the desired output. This displays the menu in [Figure 3.2.68 on page 3.2.105](#).

Figure 3.2.68: Output Editing Menu

Remote Output 1	
Channel	RF On/Off
Control	Active Low
Level	1
<input type="button" value="Cancel"/> <input type="button" value="Save"/>	

SELECT OUTPUT CHANNEL

From the editing screen for remote output 1 through 6, you can configure the output for one of a variety of channel outputs. Click the Channel field's up/down arrows to display the following options:

- ❖ Unassigned. No alarm or status parameter is monitored.
- ❖ RF On/Off. The active logic level indicates the transmitter's RF power stage is on (enabled). The inactive logic level indicates the transmitter's RF power stage is off.
- ❖ RF Output Fault. The active logic level indicates that an alarm is occurring that affects the RF output (power inhibition or power reduction).
- ❖ Preset 1 Active. Preset 1's output will be indicated by a logic low. The remaining, non-active preset outputs will be open collector.
- ❖ Preset 2 Active. Preset 2's output will be indicated by a logic low. The remaining, non-active preset outputs will be open collector.
- ❖ Remote Status. An active logic low level indicates remote control is enabled (i.e., local plus remote). The inactive logic level indicates remote control is disabled.
- ❖ Overall Summary Alarm. The active logic level indicates that an alarm is occurring. Any transmitter alarm can be selected as a remote output. Refer to the Troubleshooting Manual for a description of each alarm.

Click Save to activate changes. Click Cancel to cancel changes and return to the Remote Outputs screen. If you save a change to a remote output via the AUI, it will also be displayed on the FPUI.

CONFIGURE OUTPUT LOGIC

You can configure the active/inactive logic for each of the six remote outputs. Click the Control field's up/down arrows to display and select one of the following:

- ❖ Active Low. Logic '0' (low) indicates the output is true (e.g., RF is on); Logic '1' (high) indicates the output is false (e.g., RF is off).
- ❖ Active High. Logic '1' (high) indicates the output is true (e.g., RF is on); Logic '0' (low) indicates the output is false (e.g., RF is off).

Click Save to activate changes. Click Cancel to cancel changes and return to the Remote Outputs screen.

Analog Outputs

There are four analog outputs - forward power, reflected power, Average PA Voltage and Total PA Current - that can be remotely monitored. These outputs are factory defined parameters and cannot be changed to other parameters, however their scaling can be configured, using the Analog Outputs page (see [Figure 3.2.69](#)), to reflect the output voltage that yields a full-scale deflection.

Figure 3.2.69: Remote I/O - Analog Outputs Page

#	Name	Sample Full Scale	Meter Full Scale	Sample Voltage	Meter Value
1	Forward Power	5 V	24000 W	0.000 V	11 W
2	Reflected Power	6 V	2400 W	0.000 V	0 W
3	Average PA Voltage	6 V	60 V	0.196 V	1.98 V
4	Total PA Current	6 V	96 A	0.000 V	0 A

Save

The values associated with each of these fixed meters are of a linear nature so that changes made to the Sample Full Scale field (allowable range is 1- 10 V, defaulted to 5 V) will be reflected in the other fields according to the following equation:

$$(\text{Meter Value}/\text{Meter Full Scale}) \times \text{Sample Full Scale} = \text{Sample Voltage}$$

NOTE: The Sample Voltage reading reflects the value that can be measured at the associated remote analog output pin for the given Meter Value. See the Installation Manual for actual remote analog output pin assignments.

Set the Sample Full Scale field, as desired, and Click the associated save button to activate the change.

Reports

The Reports page allows the user to view and download transmitter events by the following criteria:

- Event History
- Active Preset
- Meters
- Settings

Event History

In the Event History report (see [Figure 3.2.70 on page 3.2.108](#)), the user can select the following criteria from the drop-down menu:

- ❖ Preset Change
- ❖ Power Change
- ❖ Freq Change
- ❖ Local Remote Change
- ❖ Alarm
- ❖ RF State Change

Press Refresh Events to provide a current list of alarms. Press Download Report to save an Excel Spreadsheet copy of the Event History to the computer/laptop connected.

Figure 3.2.70: Reports - Event History

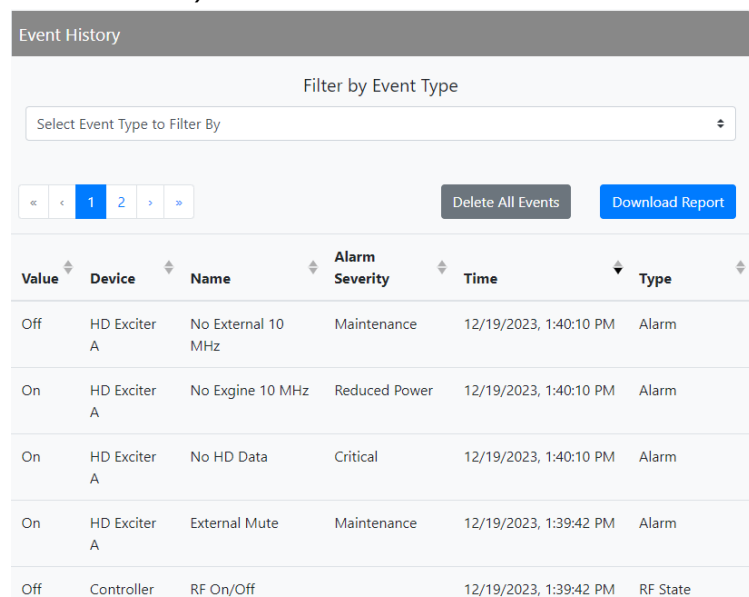

Value	Device	Name	Alarm Severity	Time	Type
Off	HD Exciter A	No External 10 MHz	Maintenance	12/19/2023, 1:40:10 PM	Alarm
On	HD Exciter A	No Engine 10 MHz	Reduced Power	12/19/2023, 1:40:10 PM	Alarm
On	HD Exciter A	No HD Data	Critical	12/19/2023, 1:40:10 PM	Alarm
On	HD Exciter A	External Mute	Maintenance	12/19/2023, 1:39:42 PM	Alarm
Off	Controller	RF On/Off		12/19/2023, 1:39:42 PM	RF State

Active Preset

In the Active Preset report (see [Figure 3.2.71 on page 3.2.109](#)), the user can select the following criteria from the drop-down menu:

- ❖ No Filter
- ❖ RDS
- ❖ SCA
- ❖ Main Audio
- ❖ Other Settings
- ❖ General

Figure 3.2.71: Reports - Active Preset

Section	Name	Value	Units
Other Settings	Two Slope Threshold	160	%
Other Settings	Two Slope Limiter	62464	
RDS	Traffic Info	0	
RDS	Stereo	0	
RDS	Scrolling Type	0	
RDS	Scrolling PS Name	C-MIC	
RDS	Scrolling Enable/Speed	0	

Meters

In the Meters report (see [Figure 3.2.72 on page 3.2.110](#)), the user can select the following criteria from the dropdown menu:

- ❖ No Filter
- ❖ Summary
- ❖ Transmitter
- ❖ Controller
- ❖ Exciter
- ❖ HD Exciter

Figure 3.2.72: Reports - Meters

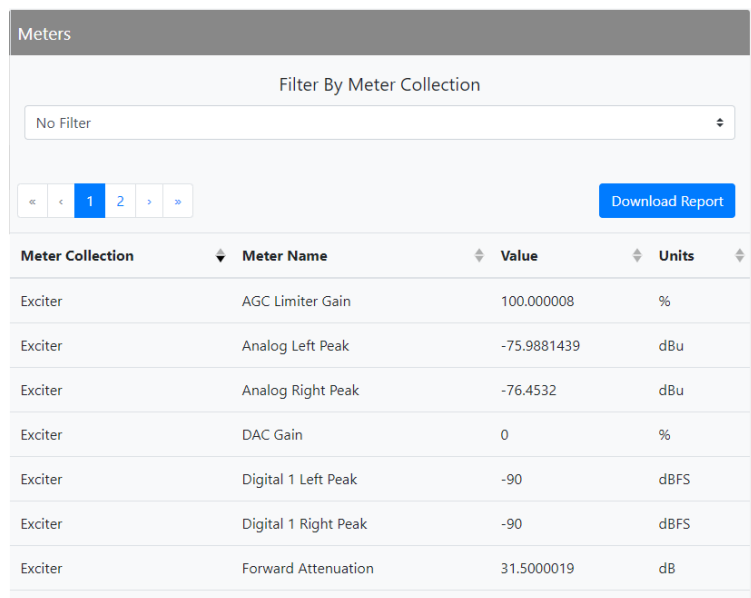

The screenshot shows a web interface for the 'Meters' report. At the top, there is a title 'Meters' and a filter section titled 'Filter By Meter Collection' with a dropdown menu currently set to 'No Filter'. Below the filter is a pagination control showing page 1 of 2, and a blue 'Download Report' button. The main content is a table with the following data:

Meter Collection	Meter Name	Value	Units
Exciter	AGC Limiter Gain	100.000008	%
Exciter	Analog Left Peak	-75.9881439	dBu
Exciter	Analog Right Peak	-76.4532	dBu
Exciter	DAC Gain	0	%
Exciter	Digital 1 Left Peak	-90	dBFS
Exciter	Digital 1 Right Peak	-90	dBFS
Exciter	Forward Attenuation	31.5000019	dB

Settings

In the Settings report (see [Figure 3.2.73 on page 3.2.111](#)), the user can select the following criteria from the dropdown menu:

- ❖ No Filter
- ❖ General
- ❖ Software Versions
- ❖ Exciter Thresholds
- ❖ Active Preset

Figure 3.2.73: Reports - Settings

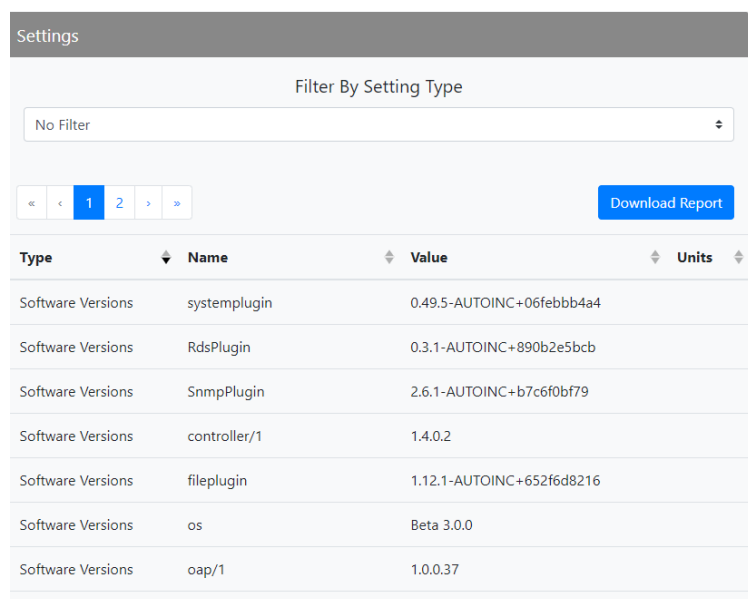

The screenshot shows a web interface for a 'Settings' report. At the top, there is a header 'Settings' and a filter section titled 'Filter By Setting Type' with a dropdown menu currently set to 'No Filter'. Below the filter is a pagination control showing page 1 of 2, and a blue 'Download Report' button. The main content is a table with columns for Type, Name, Value, and Units. The table lists several software version entries.

Type	Name	Value	Units
Software Versions	systemplugin	0.49.5-AUTOINC+06febb4a4	
Software Versions	RdsPlugin	0.3.1-AUTOINC+890b2e5bcb	
Software Versions	SnmpPlugin	2.6.1-AUTOINC+b7c6f0bf79	
Software Versions	controller/1	1.4.0.2	
Software Versions	fileplugin	1.12.1-AUTOINC+652f6d8216	
Software Versions	os	Beta 3.0.0	
Software Versions	oap/1	1.0.0.37	

Software

The Software menu contains the following sub-menus:

- Software Upgrades (see [Software Upgrades](#))
- Software Versions (see [Software Versions on page 3.2.113](#))

Software Upgrades

NOTE: Nautel provides a transmitter update mechanism by connecting a USB drive to the rear USB ports of the GV2 controller. Nautel will provide instructions on how to create a USB drive and complete the update or provide preprogrammed USB drives with instructions.

The AUI's Software Upgrades page (see [Figure 3.2.74](#)) in the Settings menu allows the user to manage the transmitter's software files (.tgz files) via remote connection. Navigate the page as described below. The display area shows all available software files.

The page consists of the following sections and buttons.

- ❖ Browse: allows the user to search for software files to upload.
- ❖ Upload: uploads the chosen file to the display area.
- ❖ Refresh List: refreshes all the available software files in the display area.
- ❖ Start Upgrade: initiates the software file selected to upgrade.
- ❖ Delete Upgrade file: deletes the selected software file from the display area.

Figure 3.2.74: Software Upgrades

The screenshot displays the 'Upgrades' interface. At the top, it shows the 'Current Version' as 'TITAN-4904 1.0.1'. Below this is the 'Add Upgrade' section, which includes a 'From' field with the placeholder 'Select upgrade file to upload' and a 'Browse' button, and a 'To' field set to 'Onboard Filesystem' with an 'Upload' button. The main area is titled 'Select upgrade for installation' and contains a table of available files:

Select upgrade for installation	Source
vs.titan.4.0.0.30.tgz	USI
vs.titan.5.0.0.30.tgz	USI
firmware.tgz	USI

At the bottom of the page, there are three buttons: 'Refresh List' (blue), 'Start Upgrade' (green), and 'Delete Upgrade File' (red).

Software Versions

The AUI's Software Versions page (see [Figure 3.2.75](#)) in the Settings menu displays the Operating version and all its associated plug-ins.

Plug-ins are referenced by Name and Version.

By clicking the Software Licenses hyperlink, the user is directed to Nautel's support website which provides a list of open source Nautel Software Licenses used by this product.

Figure 3.2.75: Software Versions

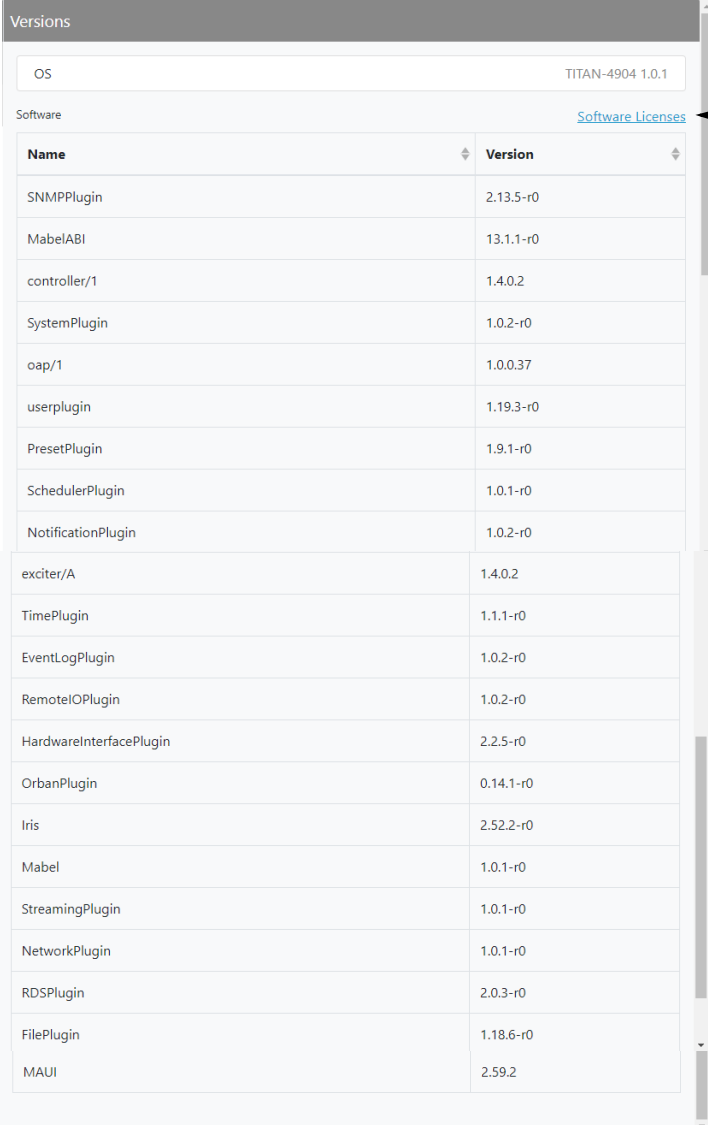

Versions	
OS	TITAN-4904 1.0.1
Software	Software Licenses
Name	Version
SNMPPlugin	2.13.5-r0
MabelABI	13.1.1-r0
controller/1	1.4.0.2
SystemPlugin	1.0.2-r0
oap/1	1.0.0.37
userplugin	1.19.3-r0
PresetPlugin	1.9.1-r0
SchedulerPlugin	1.0.1-r0
NotificationPlugin	1.0.2-r0
exciter/A	1.4.0.2
TimePlugin	1.1.1-r0
EventLogPlugin	1.0.2-r0
RemoteIOPugin	1.0.2-r0
HardwareInterfacePlugin	2.2.5-r0
OrbanPlugin	0.14.1-r0
Iris	2.52.2-r0
Mabel	1.0.1-r0
StreamingPlugin	1.0.1-r0
NetworkPlugin	1.0.1-r0
RDSPlugin	2.0.3-r0
FilePlugin	1.18.6-r0
MAUI	2.59.2

Air Chain

NOTE: HD Air Chain operation not available for GV2 SW 1.0.0 and is planned for future releases.

The Air Chain menu contains the following three sub-menus:

- Virtual Platform Configuration
- Remote Support (see [Remote Support on page 3.2.116](#))
- Air Chain Versions (see [Air Chain Versions on page 3.2.117](#))

Virtual Platform Configuration

The Virtual Platform Configuration page (see [Figure 3.2.76 on page 3.2.115](#)) allows the user to set the two DNS Server IP addresses, the Default Gateway and parameters for the two LAN connections (LAN1 and LAN2)

The LAN1 and LAN 2 Mode dropdown menus have 3 options for the user to select from:

- ❖ Off
- ❖ DHCP
- ❖ Static

The two LAN connections have specific uses in transmitting HD Air Chain information. The LAN1 network connection is used for the content to be broadcast while the LAN2 network connection is used for controlling the vPlatform.

The UP parameter shows an indication if the Network connection is available (true) or not (false).

The Connected parameter shows an indication if the site's network's internet connection is available (true) or not (false).

Figure 3.2.76: Virtual Platform Configuration

Virtual Platform Configuration

DNS Servers

DNS 1*	10.0.1.200
DNS 2*	10.0.1.222

Default Gateway

Gateway*	0.0.0.0
----------	---------

LAN1

Mode	OFF ▾
MAC Address	0:18:7D:D5:F9:53
IP Address*	0.0.0.0
Subnet Mask*	0.0.0.0
Up	true
Connected	true

LAN 2

Mode	OFF ▾
MAC Address	0:18:7D:D5:F9:54
IP Address*	0.0.0.0
Subnet Mask*	0.0.0.0
Up	true
Connected	true

Cancel Save

Remote Support

The Remote Support page (see [Figure 3.2.77](#)) offers an optional feature that allows Nautel customer service to access, troubleshoot and adjust/correct the transmitter. Use this screen as directed by customer service.

The Remote Support service is disabled by default and is enabled by the user for a limited amount of time, as configured via the Duration field, after which remote access will automatically be disabled again. Slide the Enable Support icon to the right to enable Remote Support (will turn green when enabled) and click Save button. Click the Cancel button to discard changes and exit this menu.

When the service is enabled, the GV2 transmitter will establish a TCP/IP network connection to the Nautel remote support server through which only Nautel can access all relevant user interface screens to diagnose and troubleshoot problems. The Nautel customer service representative will assign a Connection ID to be entered for the troubleshooting duration, as well as a URL and port number for the server if the default values need to be changed.

Figure 3.2.77: Remote Support

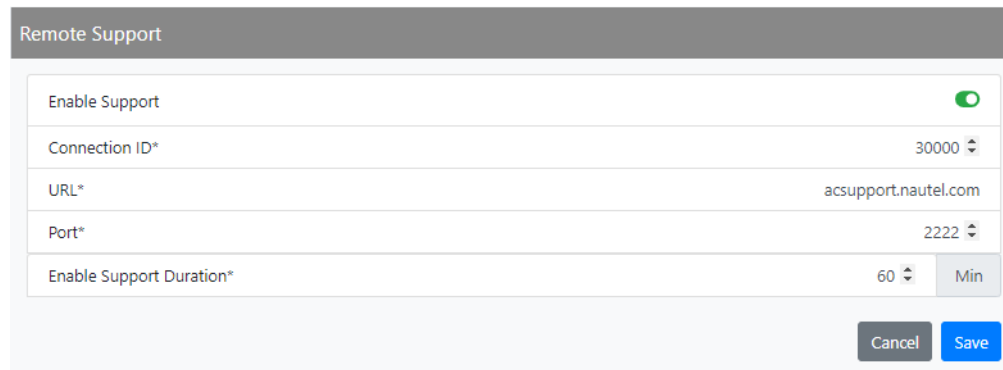

The screenshot shows a web interface titled "Remote Support". It contains a form with the following fields and controls:

- Enable Support:** A toggle switch that is currently turned on (green).
- Connection ID*:** A dropdown menu showing the value "30000".
- URL*:** A text input field containing "acsupport.nautel.com".
- Port*:** A dropdown menu showing the value "2222".
- Enable Support Duration*:** A dropdown menu showing "60" and a "Min" button next to it.

At the bottom right of the form, there are two buttons: "Cancel" (grey) and "Save" (blue).

Air Chain Versions

The Air Chain Versions page (see [Figure 3.2.78](#)) in the Air Chain menu displays the operating versions of the vPlatform, SPD Driver and the Proxmox which are referenced by Name and Version.

Figure 3.2.78: Air Chain Versions

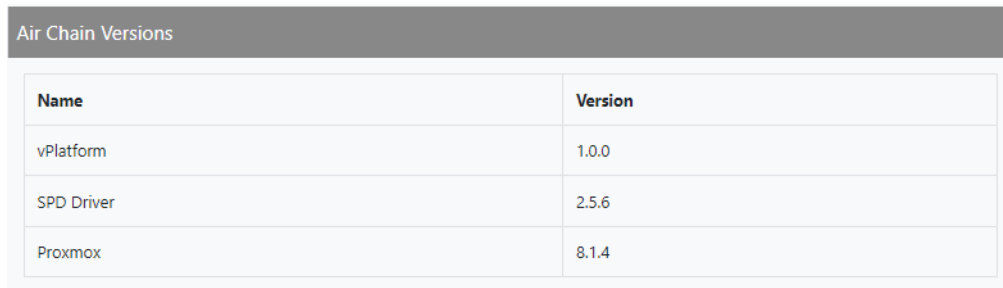

Name	Version
vPlatform	1.0.0
SPD Driver	2.5.6
Proxmox	8.1.4

Sign Out

The Sign Out dialog (see [Figure 3.2.79](#)) allows the user to sign out of the AUI session.

Click OK to sign out or Cancel to return to the active session.

Figure 3.2.79: Sign out

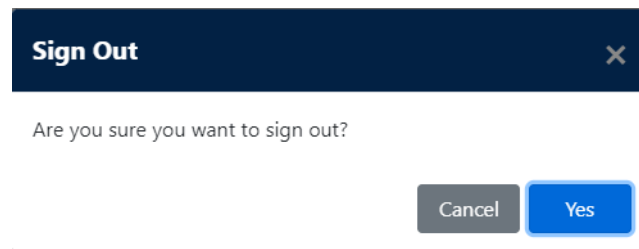

Controller Front Panel UI (User Interface)

The controller's front panel has a user interface (UI) featuring a 4 x 20 character graphic LCD display (see [Figure 3.2.81 on page 3.2.119](#)). The UI can be controlled by its adjacent keypad. The UI contains a menu-based series of pages that serve specific functions. Similar interfacing, as well as more advanced functionality, is available on the AUI (see [Advanced User Interface \(AUI\), on page 3.2.9](#)). The controller front panel also has push-button switches that allow RF on, RF off and local/remote selection (see [Navigational Buttons, on page 3.2.119](#)).

LCD Display (UI)

This display shows all the UI screens. The display's top level screen, used for viewing purposes only, is shown in [Figure 3.2.80](#).

Figure 3.2.80: Top Level Screens

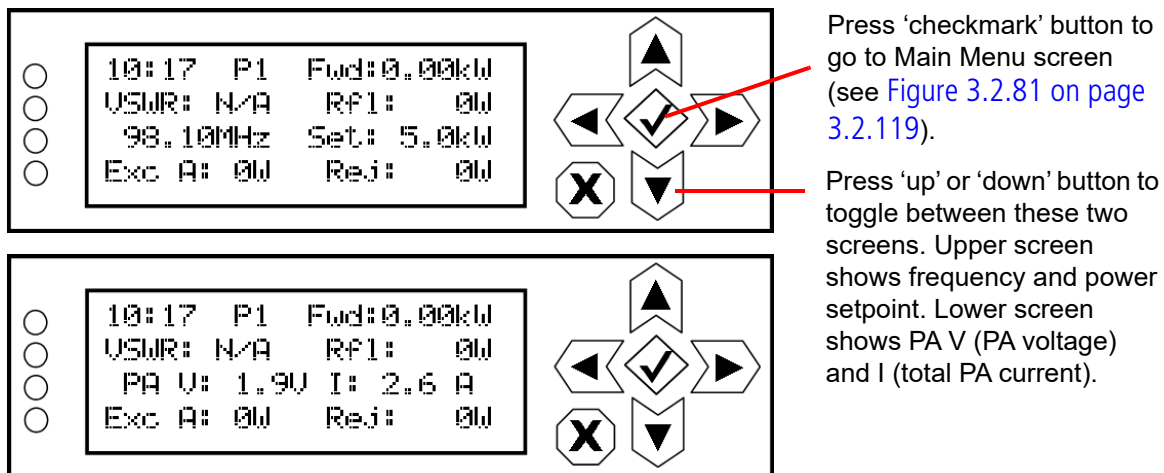

The top level screen displays the following information:

- ❖ Line 1: current time, active preset (e.g., P1) and the transmitter's actual forward power.
- ❖ Line 2: VSWR ratio and the transmitter's reflected power level.
- ❖ Line 3: operating frequency and the desired power setpoint (or PA voltage and total PA current).
- ❖ Line 4: active exciter's forward power level and the total system reject power.

Main Menu

This main menu is the starting point for navigating through the UI screens. See [Table 3.2.4 on page 3.2.121](#) for a list of screens and their basic functions.

Figure 3.2.81: Main Menu

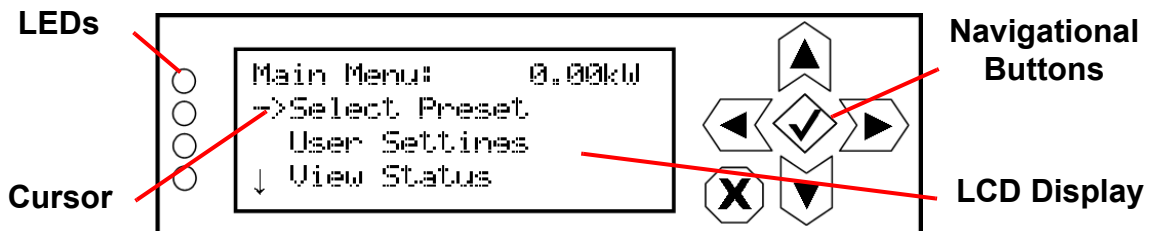

Navigational Buttons

There are six push-buttons on the right-hand side of the LCD display that allow navigation through the UI pages, as well as modifying selected settings.

- ❖ Up and down - on menu and list screens, moves cursor up and down through the associated page; on edit screens, increases and decreases the value of a parameter being modified.
- ❖ Left - on menu and list screens, exits to the next higher level screen; on edit screens, moves the editing cursor left, as applicable.
- ❖ Right - on menu and list screens, goes to the next lower level screen; on edit screens, moves the editing cursor right, as applicable.
- ❖ Checkmark - on menu screens, goes to the next lower level screen; on edit screens, acts as an "accept" or "save" function; in some cases the display will prompt its use.
- ❖ X - on menu and list screens, exits to the next higher level screen; on edit screens, acts as a "cancel" function; in some cases the display will prompt its use.

Saving Settings

Many of the UI screens allow for modifying a selected setting. Use the checkmark button to save a change. Use the X button to cancel a change and revert back to the previously stored value.

LEDs

There are four LEDs on the left-hand side of the LCD display that provide the operational status of various sections of the transmitter - Exciter, Power Amplifier, Output Network and Power Supply (see [Figure 3.2.81](#) on [page 3.2.119](#)). The LEDs can glow green, amber or red. Typically, green indicates normal operation, amber indicates a warning, and red indicates a fault or error. Refer to the Troubleshooting section for more detailed information on LED status.

Controller Pushbuttons

The controller front panel contains three pushbutton switches that provide local control of the transmitter's RF on/off status and the local/remote operational control status (see [Figure 3.2.82](#)).

Figure 3.2.82: Front Panel Pushbutton Switches

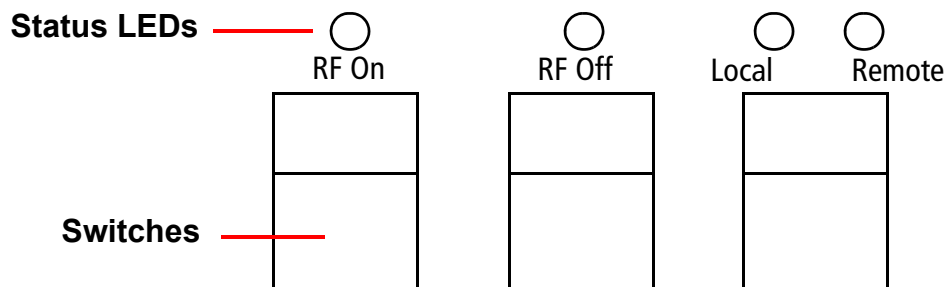

- ❖ RF On - In local mode, press the pushbutton switch to turn on the RF power stage and cooling fans. The RF On LED will be on (amber) when the RF power stage is on and the external interlock circuit is intact. The transmitter will operate at the level stored in the selected preset.
- ❖ RF Off - Regardless of the remote enable/disable status, press the pushbutton switch to turn off the RF power stage. The RF Off LED will be on (amber) when the RF power stage is off.

NOTE: The RF On and RF Off LEDs may blink if there are alarms occurring that prevent the transmitter from enabling the RF power stage (e.g., interlock open, combiner matching, etc.)

- ❖ Local/Remote - Press the switch to toggle between "remote enabled" (Remote amber LED on; local and remote control) and "remote disabled" (Remote LED off; local control only). The transmitter's local controls are always enabled. In Local mode (Local amber LED on), all of the remote controls (except the external interlock) are disabled. In Remote mode, control of transmitter functions is also provided to the remote (web-accessed) AUI or remote input/output control via the remote interface PWB or the rear of the controller module. The bottom of the remote AUI home page will display the control status. When remote control is enabled, only the Remote button is green. When remote control is disabled, only the Local button is green.

Controller UI Screens

Table 3.2.4 defines the available UI display screens on the controller module.

Table 3.2.4: Controller UI Screens

Controller UI Screen	Function	See Page
Main Menu	Choose options and navigate to other screens.	3.2.119
Select Preset	Select and activate a user-defined preset.	3.2.126
User Settings	Edit various transmitter user settings (see other User Settings options in this table).	3.2.127
User Settings - Edit Presets	Edit various parameters for a user-defined preset (see the following rows for all Edit Presets options).	3.2.128
User Settings - Edit Presets - Output Power	Edit the selected preset's output power.	3.2.129
User Settings - Edit Presets - Frequency	Edit the selected preset's operating frequency.	3.2.129
User Settings - Edit Presets - IBOC Mode	Edit the selected preset's mode of operation (FM, FM+HD, HD or DRM+).	3.2.130
User Settings - Edit Presets - IBOC Settings	Edit the selected preset's settings for IBOC (digital) operation.	3.2.131
User Settings - Edit Presets - Main Audio	Edit the selected preset's main audio characteristics such as source, stereo mode, pre-emphasis and low pass filtering.	3.2.133
User Settings - Edit Presets - Backup Audio	Enable and edit the selected preset's backup audio characteristics such as source, stereo mode, pre-emphasis and low pass filtering.	3.2.135
User Settings - Edit Presets - Pilot Settings	Edit the selected preset's pilot settings such as level, phase and 1 PPS synchronization.	3.2.136
User Settings - Edit Presets - SCA Settings	Edit the selected preset's SCA settings such as SCA reduction, MPX SCAs, MPX SCA input and internal SCA (1 and 2) generator characteristics.	3.2.137
User Settings - Edit Presets - RDS Settings	Edit the selected preset's RDS settings such as enable/disable, data source, baud rate, level, phase, program type, alternate frequency data, etc.	3.2.139

Table 3.2.4: Controller UI Screens

Controller UI Screen	Function	See Page
User Settings - Edit Presets - Limiter Settings	Edit the selected preset's limiter settings. Limiter types include hard limiter, AGC limiter, 2-slope limiter, L/R limiter and MPX RMS limiter.	3.2.144
User Settings - Edit Presets - Mod Loss	Edit the selected preset's modulation loss functionality, such as enable/disable, setting threshold, setting timeout period, setting resulting action and selecting a backup preset.	3.2.148
User Settings - Edit Presets - Audio Delay	Edit the selected preset's audio delay.	3.2.150
User Settings - Edit Presets - Copy Another Preset	Copy the selected preset's settings to another preset.	3.2.150
User Settings - Set Clock	Set precise time and date.	3.2.151
User Settings - Network Settings	View and/or set network information such as MAC address (view only), DHCP on/off status, IP address, netmask and gateway.	3.2.152
User Settings - Pilot Sample	Set the pilot sample level for the controller's rear panel BNC connector.	3.2.155
User Settings - Signal Gen	Enable/disable and setup the internal signal generator.	3.2.156
User Settings - Ext. 10 MHz Inp	Enable/disable the use of an external 10 MHz signal.	3.2.158
User Settings - Scheduler	Enable/disable the scheduler.	3.2.159
User Settings - FM Mask	Select the FM mask - FCC, ETSI or None (turns off mask).	3.2.160
User Settings - Audio Low	Set the low audio thresholds and associated timeout delays.	3.2.161
User Settings - Turn-On Delay	Set the transmitter turn-on delay period.	3.2.162
User Settings - Ramp-Up Speed	Set the transmitter's ramp-up delay period.	3.2.163
User Settings - Transfer Ctrl (if applicable)	Control the on/off status of transmitters by controlling RF mute circuits	See VS-TC-HP manual
View Status	View various transmitter parameters (see other View Status options in this table).	3.2.164
View Status - View Alarms	View all active transmitter alarms.	3.2.164

Table 3.2.4: Controller UI Screens

Controller UI Screen	Function	See Page
View Status - View Meters	View the levels of various transmitter parameters, including forward power, reflected power, PA voltage, PA current and low level dc supply voltages.	3.2.165
View Status - View Log	View the transmitter's events log, including alarms, commands, etc.	3.2.165
View Status - Clear Log	Clear the transmitter's events log.	
View Status - View SW Versions	View the versions of software installed on the transmitter.	-
Reset Alarms	Initiate an attempt to reset all alarms controlled by latched protection circuits.	3.2.168
Changeover	For dual exciters, controls the auto exciter transfer function. You can also enable the standby exciter test function (local control only).	3.2.169
System Settings	Edit various transmitter system settings (see other System Settings options in this table).	3.2.171
System Settings - Host Reset	Initiate a reset of the host (SBC).	3.2.172
System Settings - Host Watchdog	Enable, disable or force a reset of the host watchdog feature.	3.2.172
System Settings - Firmware Update	Perform a software upgrade on the transmitter.	3.2.173
System Settings - LCD Settings	Set the front panel display's contrast, backlight and timeout.	3.2.173
System Settings - Exciter TCXO	Calibrate the internal clock to a user supplied external high precision 10 MHz clock reference	3.2.175
System Settings - HD Optimizer	Set parameters for the HD Optimizer feature, which can be used to maximize the efficiency of the transmitter's RF spectrum.	3.2.176
System Settings - HW Config	Configure various system hardware parameters (see other System Settings - HW Config options in this table).	3.2.178
System Settings - HW Config - Installed Exc	Configures the transmitter for single or dual exciter installation.	3.2.179
System Settings - HW Config - LVPS Hardware	Configures the transmitter for single or redundant LVPS installation.	3.2.179

Table 3.2.4: Controller UI Screens

Controller UI Screen	Function	See Page
System Settings - HW Config - LVPS Voltage	Set the normal-state level of the low voltage power supply.	3.2.182
System Settings - HW Config - Fan Speed	Set the normal-state speed of the transmitter's cooling fans.	3.2.182
System Settings - HW Config - UPS Installed	Set the transmitter for UPS operation.	3.2.183
System Settings - HW Config - Audio Processor	Set audio processor to none or Orban Inside.	-
System Settings - FM Polarity	Set the polarity for FM deviation; positive modulation signal yields positive frequency deviation or negative modulating signal yields positive frequency deviation.	3.2.184
System Settings - Factory Settings	Sets critical thresholds, calibration values and operating values for key transmitter parameters. These settings are established at the factory and do not normally require user adjustment (see other System Settings - Factory Settings options in this table).	3.2.185
System Settings - Factory Settings - Thresholds	Set protection thresholds for various parameters (e.g., SWR shutback, high/low exciter PA power, low/very low forward power, etc.).	3.2.186
System Settings - Factory Settings - Calibration	Set calibration values or run calibration routines for various parameters (e.g., forward/reflected power, program input levels, etc.).	3.2.187
System Settings - Factory Settings - Exciter PA Power	Set the normal operating power level for the active exciter, in FM mode.	3.2.189
System Settings - Factory Settings - Exciter HD PA V	Set the HD exciter's PA voltage.	3.2.189
Remote I/O	Configure the remote inputs, remote outputs and analog outputs for the transmitter.	3.2.190
Orban Audio Processor	Configure, enable and operate the optional Orban audio processor after it is installed in your transmitter.	3.2.194
Configuring the Transmitter for the Orban Audio Processor	Configures the transmitter for use with the Orban Audio Processor.	3.2.195
Enabling the Orban Audio Processor for Preset Selection	Enable the Orban audio processor to allow preset selection using either the controller UI or the AUI.	3.2.196

Table 3.2.4: Controller UI Screens

Controller UI Screen	Function	See Page
Selecting an Orban Audio Processor Preset	Select an Orban audio processor preset using either the AUI or the controller UI.	3.2.198

Select Preset

The Presets page allows users with the appropriate permissions to view operational data (power level, frequency, mode, program input characteristics), plus create and control preset settings. Users can create up to 62 presets or edit existing presets. To view the Presets page, select Presets in the Menu page.

Selecting the Active Preset

When you choose Select Preset from the Main Menu (see [Figure 3.2.83](#)) you can select the active preset for transmitter operation.

Figure 3.2.83: Select Preset screen

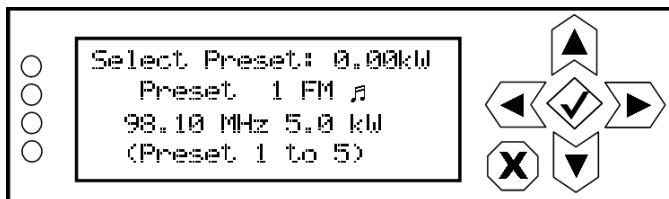

Use the up and down buttons to scroll through the existing presets. Press the accept (checkmark) button to enable the preset as the transmitter's active preset. Press the cancel (X) button to return to the previous menu.

User Settings

You can establish various user settings for the GV2-10/GV2-7.5 using the controller's UI. Several User Settings were described previously in this section (e.g., Edit Presets, Set Clock, Network Settings, etc.). The following additional options are available:

- Edit Presets: see [Edit Presets](#), on page 3.2.128
- Set Clock: see [Setting the Clock](#), on page 3.2.151
- Network Settings: see [Network Setup](#), on page 3.2.152
- Pilot Sample: see [Setting Pilot Sample Level](#), on page 3.2.155
- Signal Gen: [Configure Test Signal Generator](#), on page 3.2.156
- Ext. 10 MHz Input: see [External 10 MHz Input](#), on page 3.2.158
- Scheduler: see [Enabling the Scheduler](#), on page 3.2.159
- FM Mask: [Selecting FM Mask](#), on page 3.2.160
- Audio Low: see [Setting User Thresholds](#), on page 3.2.161
- Turn-on Delay: [Turn-On Delay Setting](#), on page 3.2.162
- Ramp-up Speed: [Ramp-Up Speed Setting](#), on page 3.2.163

Edit Presets

When you select User Settings -> Edit Presets from the Main Menu (see [Figure 3.2.84](#)) you can create up to 63 operating presets or edit existing presets.

Figure 3.2.84: Edit Preset screen

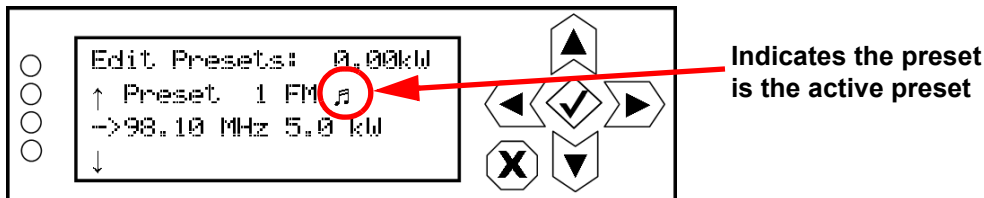

Use the up and down buttons to scroll through the existing presets, or scroll to the bottom of the list to Create New Preset (see [Figure 3.2.85](#)). Press the accept (checkmark) button to enter the editing menu for that preset (see [Figure 3.2.86](#)). Press the cancel (X) button to return to the previous menu. When you create a new preset, the next available preset number is assigned (e.g., Preset 5).

Figure 3.2.85: Create New Preset screen

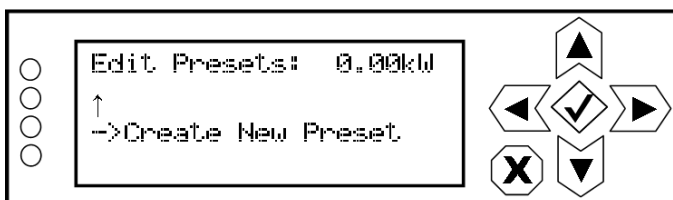

Figure 3.2.86: Preset Editing menu



Within the Preset Editing menu, use the up and down buttons to scroll through the options and press the accept (checkmark) button to enter the selected editing menu/screen. Press the cancel (X) button to return to the previous menu. Parameters that can be edited are:

Output Power

Output power limits are a function of the transmitter mode of operation. See Table 1-1 of the Pre-Installation Manual for RF output power ratings. The following exceptions apply:

- For hybrid (FM+HD) mode, the maximum power setpoint is 5% (1.05 times) higher than the rated value shown for "Analog Power MP3" in Table 1-1 of the Pre-Installation Manual for a specific injection level. For example, when operating in FM+HD mode with a -20 dB injection level, you can set to a maximum power level of 10.5 kW (for GV10) or 8.66 kW (for GV7.5).

See [Figure 3.2.87](#). Use the up and down buttons to edit the output power (in 50 W increments, then press the accept (checkmark) button to save the change. Press the cancel (X) button to discard changes and return to the previous menu.

Figure 3.2.87: Output Power screen

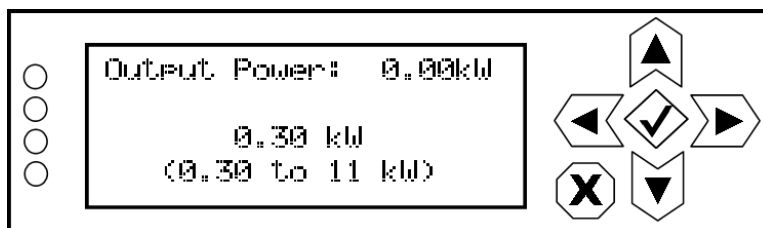

Frequency

See [Figure 3.2.88](#). Use the up and down buttons to edit the carrier frequency (in 0.01 MHz increments, then press the accept (checkmark) button to save the change. Press the cancel (X) button to return to the previous menu.

Figure 3.2.88: Frequency screen

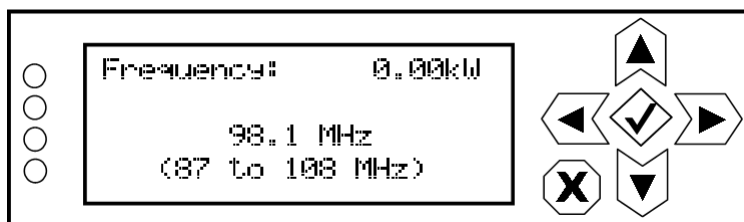

IBOC Mode

See [Figure 3.2.89](#). Use the up and down buttons to select the overall transmission mode, noting the options below, then press the accept (checkmark) button to save the change. Press the cancel (X) button to return to the previous menu.

Figure 3.2.89: IBOC Mode screen

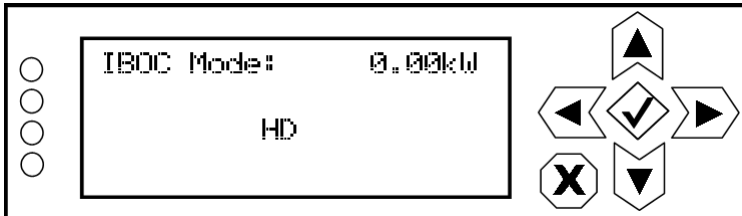

IBOC mode options include:

- ❖ FM: an analogue only mode, transmits a carrier, frequency modulated with audio.
- ❖ HD: all digital mode; this mode transmits the upper and lower digital sidebands of OFDM IBOC carriers. HD transmitter is typically high-level combined (coupler or spatial) with a paired FM only transmitter. See [IBOC Settings, on page 3.2.131](#) for additional calibration settings. This mode requires additional hardware.
- ❖ FM+HD: also known as hybrid/simulcast or low-level combined, this mode transmits the analog carrier (FM modulated) and the upper and lower digital sidebands of OFDM IBOC carriers. See [IBOC Settings, on page 3.2.131](#) for additional calibration settings. This mode requires additional hardware.
- ❖ DRM+: transmits a DRM OFDM signal using the I/Q stream from a DRM modulator connected to the desired AES input. See [IBOC Settings, on page 3.2.131](#) for additional calibration settings. This mode requires additional hardware.

IBOC Settings

See [Figure 3.2.90](#). When you select IBOC Settings from the Preset editing options screen, you can edit various IBOC parameters

Figure 3.2.90: IBOC Settings menu

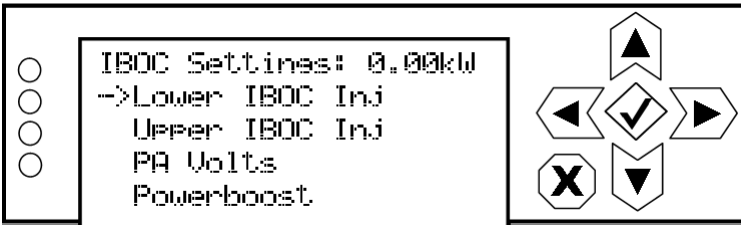

Use the up and down buttons to scroll through the IBOC settings options, then press the accept (checkmark) or right arrow button to enter the selected editing screen. [Figure 3.2.91 on page 3.2.132](#) shows the editing screens for the IBOC Settings menu. Press the cancel (X) button to discard changes and return to the previous menu.

Figure 3.2.91: IBOC Settings editing screens

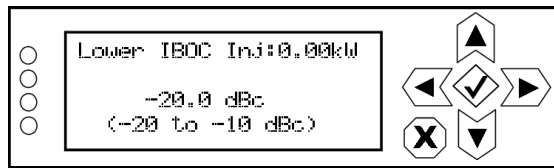

For FM+HD and HD modes, use the up and down buttons to select a value between -20 and -10 dB for the IBOC injection level of the lower sideband of digital carriers. This value determines the relationship between the digital carriers power and the analog carrier power. Example: -20 dBc indicates that the total RMS power of the digital carriers will be 1% of the total RMS power of the analog carrier. -10 dB indicates that the total RMS power of the digital carriers will be 10% of the total RMS power of the analog carrier.

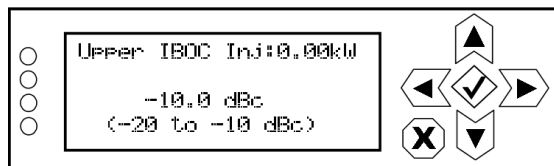

For FM+HD and HD modes, use the up and down buttons to select a value between -20 and -10 dB for the IBOC injection level of the upper sideband of digital carriers. This value determines the relationship between the digital carriers power and the analog carrier power. Example: -20 dBc indicates that the total RMS power of the digital carriers will be 1% of the total RMS power of the analog carrier. -10 dB indicates that the total RMS power of the digital carriers will be 10% of the total RMS power of the analog carrier.

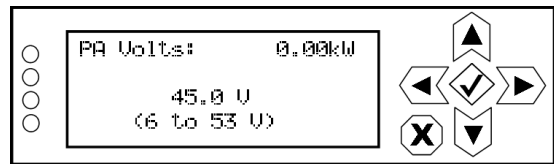

NOTE: The preferred option to maximize IBOC performance is by using the HD Optimizer feature (see [HD Optimizer, on page 3.2.176](#)). In this case, leave PA Volts setting at its default value (53.0 V).

For FM+HD, HD and DRM+ modes, use the up and down buttons to enter a value between 30.0 V and 53.0 V. This value sets the drain voltage applied to the PAs in the RF power modules, from their associated power supplies. This value affects IBOC/DRM+ performance. Larger values result in an improved spectrum, but decreased efficiency. Conversely, smaller values result in improved efficiency, but degrade the spectrum. Typical values are between 35 V and 50 V, and depend on many variables such as power level, frequency and injection level.

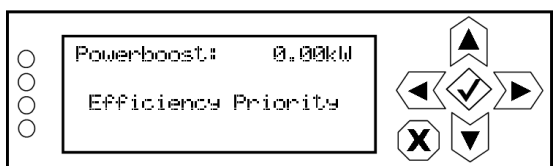

For FM+HD mode only. Use the up and down buttons to toggle between Efficiency Priority (default setting) and MAX MER Priority. Selecting Efficiency Priority instructs the PowerBoost function to make efficiency and power capability the priority when reducing the peak-to-average power ratio, while ensuring that the MER (modulation error ratio) of the transmitted HD signal meets transmission requirements.

Selecting MAX MER Priority instructs the PowerBoost function to make maximum MER the priority. Transmitter efficiency and power capability will be reduced as a result.

PowerBoost is only available in transmitters with the appropriate exciter configuration.

Main Audio

When you select Main Audio from the Preset editing options screen, you can edit various main audio parameters (see [Figure 3.2.92](#)).

Figure 3.2.92: Main Audio menu



Use the up and down buttons to scroll through the main audio menu options, then press the accept (checkmark) or right arrow button to enter the selected editing screen. [Figure 3.2.93 on page 3.2.134](#) shows the editing screens for the Main Audio menu. Press the cancel (X) button to discard changes and return to the previous menu.

Figure 3.2.93: Main Audio editing screens

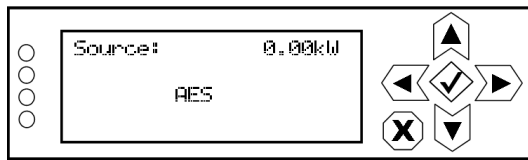

Use the up and down buttons to locate the desired audio source - MPX, Analog L/R, MPX Over AES, Audio Player -> AES 2, Audio Player -> AES 1, AES 2 or AES 1, then press the accept (checkmark) button to save the change. Press the cancel (X) button to discard changes and return to the previous menu.

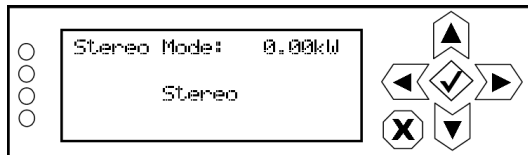

Use the up and down buttons to locate the desired stereo mode - Stereo, Right Mono, Left Mono or L+R Mono then press the accept (checkmark) button to save the change. Press the cancel (X) button to discard changes and return to the previous menu.

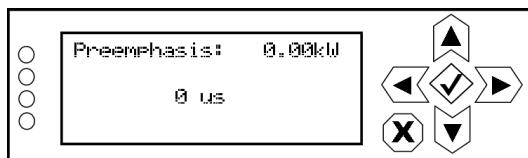

Use the up and down buttons to locate the desired preemphasis characteristic - 0 us, 25 us, 50 us or 75 us, then press the accept (checkmark) button to save the change. Press the cancel (X) button to discard changes and return to the previous menu.



Use the up and down buttons to toggle between ON or OFF, then press the accept (checkmark) button to save the change. Press the cancel (X) button to discard changes and return to the previous menu. Default setting is OFF.

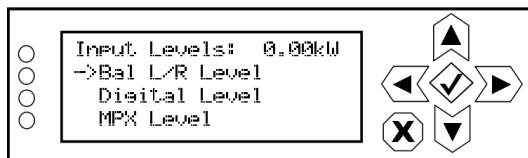

Use the up and down buttons to move the cursor to the desired audio input and then press the right button to enable editing of the parameter. [Figure 3.2.94 on page 3.2.135](#) shows all the editing screens for the Input Levels sub-menu. Within any of the editing screens, use the up and down buttons to edit a parameter value, noting the minimum and maximum limitations indicated at the bottom of the display. When complete, press the accept (checkmark) button to save the change. Press the cancel (X) button to discard changes and return to the previous menu.

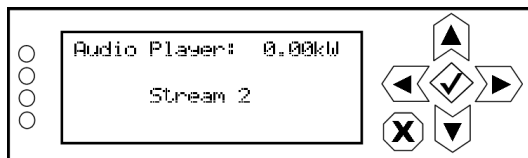

Use the up and down buttons to select File Playlist or Stream 1 through Stream 255, then press the accept (checkmark) button to save the change. Press the cancel (X) button to discard changes and return to the previous menu.

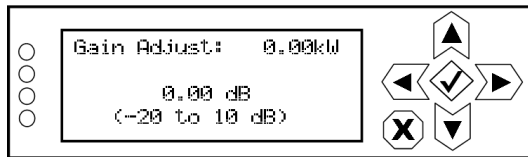

Use the up and down buttons to select again adjust level between -20 and 10 dB (in 0.01 dB increments), then press the accept (checkmark) button to save the change. Press the cancel (X) button to discard changes and return to the previous menu.

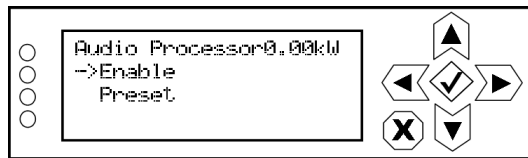

Use the up and down buttons to move the cursor to the desired sub-menu (Enable or Preset) and then press the right button to enable editing within the sub-menu. See [Urban Audio Processor, on page 3.2.194](#) for more details. Press the cancel (X) button to discard changes and return to the previous menu.

Figure 3.2.94: Input Levels editing screens

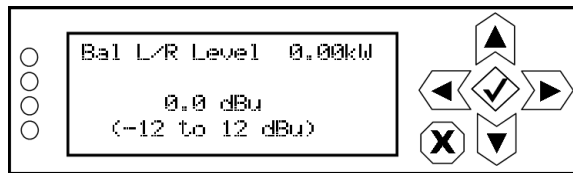

Use the up and down buttons to select a level between -12 and 12 dBu (in 0.1 dBu increments) then press the accept (checkmark) button to save the change. Press the cancel (X) button to discard changes and return to the previous menu. Default level is 0.0 dBu.

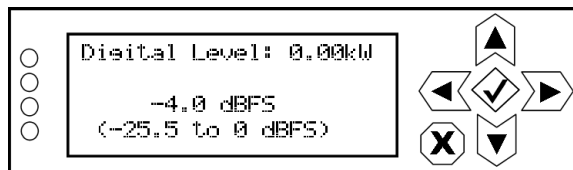

Use the up and down buttons to select a level between -25.5 and 0 dBFS (in 0.1 dBFS increments) then press the accept (checkmark) button to save the change. Press the cancel (X) button to discard changes and return to the previous menu. Default level is -4.0 dBFS.

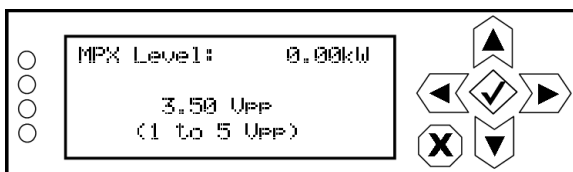

Use the up and down buttons to select a level between 1 and 5 V peak-to-peak (in 0.1 V increments), then press the accept (checkmark) button to save the change. Press the cancel (X) button to discard changes and return to the previous menu. Default level is 3.5 V pp.

Backup Audio

When you select Backup Audio from the Preset editing options screen, you can enable a backup audio source and edit various backup audio parameters (see [Figure 3.2.95](#)).

Figure 3.2.95: Backup Audio menu



See [Configuring a Mod Loss Backup Preset](#), on page 3.4.6 for limitations on audio backup settings.

Use the up and down buttons to scroll through the backup audio menu options, then press the accept (checkmark) or right arrow button to enter the selected editing screen. With the exception of the Enable screen (select ON to enable, OFF to disable), the editing screens for the Backup Audio menu are the same as the Main Audio menu (see [Figure 3.2.93 on page 3.2.134](#)). Press the cancel (X) button to discard changes and return to the previous menu.

Pilot Settings

When you select Pilot Settings from the Preset editing options screen, you can edit the settings of the pilot signal (see [Figure 3.2.96](#)).

Figure 3.2.96: Pilot Settings menu

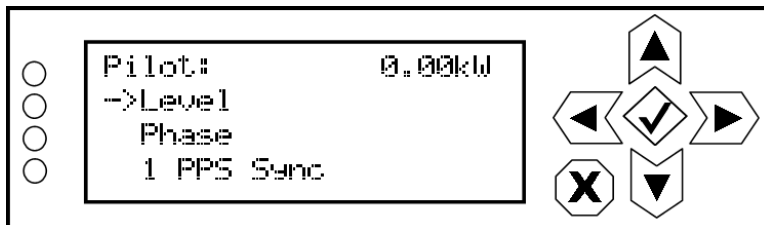

Use the up and down buttons to move the cursor to the desired pilot setting and then press the right button to enable editing of the parameter. [Figure 3.2.97](#) shows all the editing screens for the Pilot Settings menu. Within any of the editing screens, use the up and down buttons to edit or toggle a parameter value, noting the minimum and maximum limitations indicated at the bottom of the display. When complete, press the accept (checkmark) button to save the change. Press the cancel (X) button to discard changes and return to the previous menu.

Figure 3.2.97: Pilot Settings editing screens

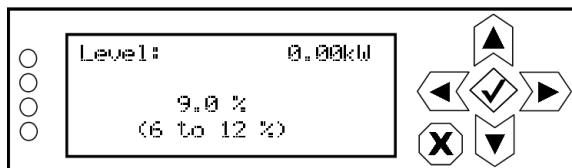

Use the up and down buttons to select a level between 6 and 12% (in 0.1% increments), then press the accept (checkmark) button to save the change. Press the cancel (X) button to discard changes and return to the previous menu. Default level is 9%.

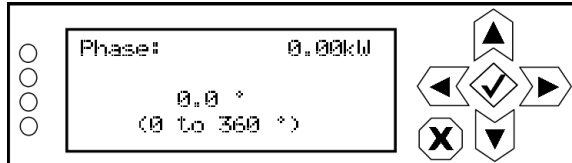

Use the up and down buttons to select a phase angle between 0 and 360 degrees (in 0.1 degree increments), then press the accept (checkmark) button to save the change. Press the cancel (X) button to discard changes and return to the previous menu. Default level is 0.0 degrees.

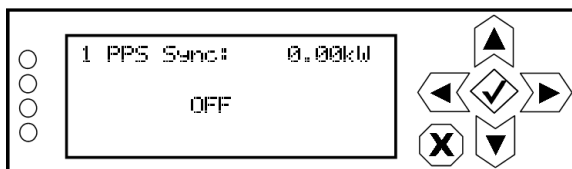

Use the up and down buttons to select ON or OFF, then press the accept (checkmark) button to save the change. Press the cancel (X) button to discard changes and return to the previous menu. Default setting is OFF.

SCA Settings

When you select SCA Settings from the Preset editing options screen, you can edit various SCA parameters (see [Figure 3.2.98](#)).

Figure 3.2.98: SCA Settings menu

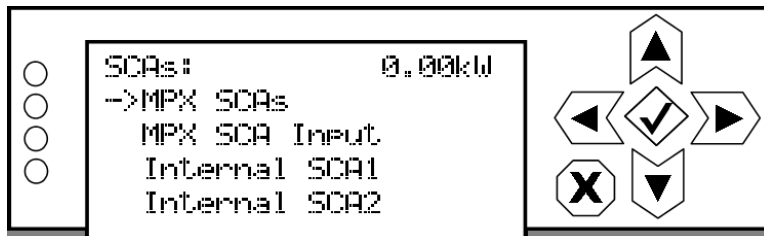

Use the up and down buttons to move the cursor to the desired SCA setting and then press the right button to enable editing of the parameter. [Figure 3.2.99](#) shows the editing screens for the SCA Settings menu. Within any of the editing screens, use the up and down buttons to edit or toggle a parameter value, noting the minimum and maximum limitations indicated at the bottom of the display. When complete, press the accept (checkmark) button to save the change. Press the cancel (X) button to discard changes and return to the previous menu.

If you select Internal SCA1 or Internal SCA2, there is a sub-menu that contains additional SCA settings (see [Figure 3.2.100](#) on page 3.2.138).

Figure 3.2.99: SCA Settings editing screens

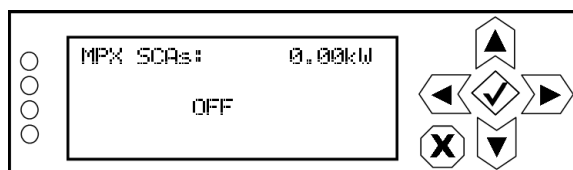

Use the up and down buttons to select ON or OFF, then press the accept (checkmark) button to save the change. Press the cancel (X) button to discard changes and return to the previous menu. Default setting is OFF.

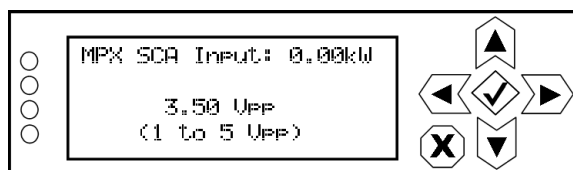

Use the up and down buttons to select a level between 1 and 5 V peak-to-peak (in 0.01 V increments), then press the accept (checkmark) button to save the change. Press the cancel (X) button to discard changes and return to the previous menu. Default level is 3.5 V pp.

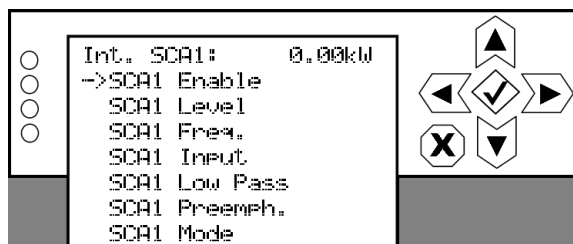

Use the up and down buttons to select the desired parameter for editing. See [Figure 3.2.100](#) on page 3.2.138 for more details. Press the accept (checkmark) button to enter the sub-menu for that parameter. Press the cancel (X) button to return to the previous menu.

Figure 3.2.100: Internal SCA1 and SCA2 editing screens

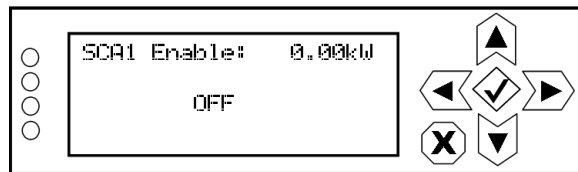

Use the up and down buttons to select ON or OFF, then press the accept (checkmark) button to save the change. Press the cancel (X) button to discard changes and return to the previous menu. Default setting is OFF.

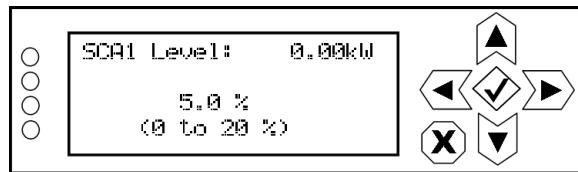

Use the up and down buttons to select a level between 0 and 20%, then press the accept (checkmark) button to save the change. Press the cancel (X) button to discard changes and return to the previous menu. Default level is 5.0%.

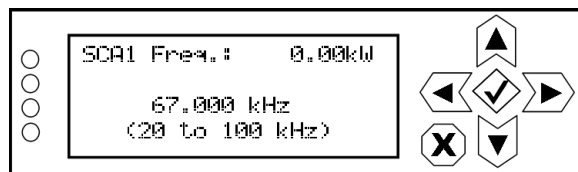

Use the up and down buttons to select a frequency between 20 and 100 kHz, then press the accept (checkmark) button to save the change. Press the cancel (X) button to discard changes and return to the previous menu. Default level is 67 kHz; typical setting is 67 kHz or 92 kHz.

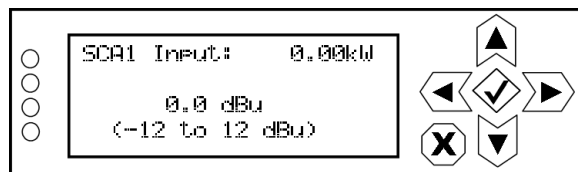

Use the up and down buttons to select a level between -12 and 12 dBu, then press the accept (checkmark) button to save the change. Press the cancel (X) button to discard changes and return to the previous menu. Default level is 0 dBu.

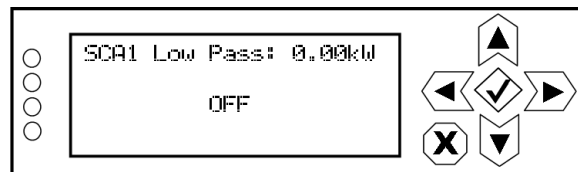

Use the up and down buttons to select ON or OFF, then press the accept (checkmark) button to save the change. Press the cancel (X) button to discard changes and return to the previous menu. Default setting is OFF.

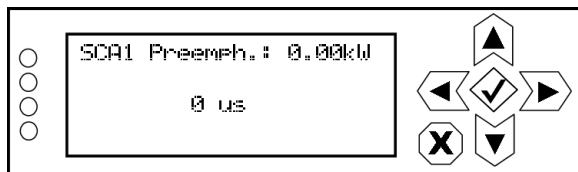

Use the up and down buttons to select a pre-emphasis of 0 us, 50 us, 75 us or 150 us, then press the accept (checkmark) button to save the change. Press the cancel (X) button to discard changes and return to the previous menu. Default level is 0 us.



Use the up and down buttons to select FM or DSB-SC, then press the accept (checkmark) button to save the change. Press the cancel (X) button to discard changes and return to the previous menu. Default setting is FM.

RDS Settings

When you select RDS Settings from the Preset editing options screen, you can edit various RDS parameters (see [Figure 3.2.101](#)).

Figure 3.2.101: RDS Settings menu

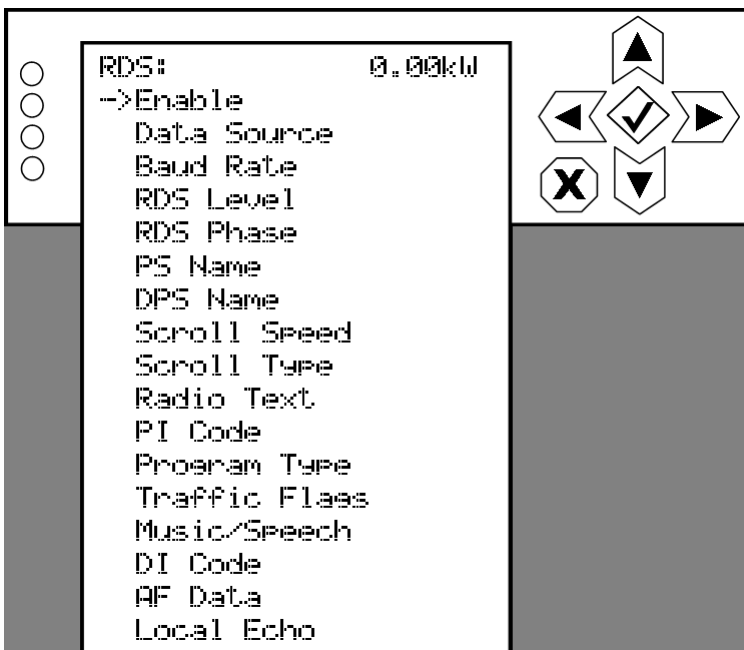

Use the up and down buttons to move the cursor to the desired RDS setting and then press the right button to enable editing of the parameter. [Figure 3.2.102 on page 3.2.140](#) and [Figure 3.2.103 on page 3.2.141](#) show all the editing screens for the RDS Settings menu. Within any of the editing screens, use the arrow buttons to edit or toggle a parameter value, noting the minimum and maximum limitations indicated at the bottom of the display (as applicable). When complete, press the accept (checkmark) button to save the change. Press the cancel (X) button to discard changes and return to the previous menu.

If you select DI Code (see [Figure 3.2.104 on page 3.2.142](#)) or AF Data (see [Figure 3.2.106 on page 3.2.143](#)), there are associated sub-menus that contain additional setting options.

Figure 3.2.102: RDS Settings editing screens (1 of 3)



Use the up and down buttons to select ON or OFF, then press the accept (checkmark) button to save the change. Press the cancel (X) button to discard changes and return to the previous menu. Default setting is OFF.

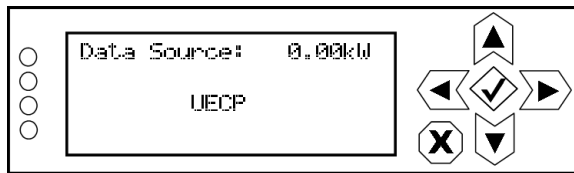

Use the up and down buttons to select Select Internal, ASCII, Ext. UECP, ASCII Over IP, or UECP Over IP, then press the accept (checkmark) button to save the change. Press the cancel (X) button to discard changes and return to the previous menu. Default setting is UECP.

NOTE: For an ASCII Over IP data source, RDS information should be sent to the IP address of the GV2-10/GV2-7.5, port 7005.

NOTE: For title/artist functionality, the GV2-10/GV2-7.5 supports the radiotext (RT) data type, using the UECP or Ext. ASCII data source.

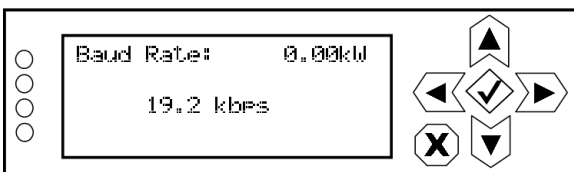

Use the up and down buttons to select Select 150 bps, 300 bps, 600 bps, 1.2 kbps, 2.4 kbps, 4.8 kbps, 9.6 kbps, 19.2 kbps, 38.4 kbps, 57.6 kbps or 115.2 kbps, then press the accept (checkmark) button to save the change. Press the cancel (X) button to discard changes and return to the previous menu. Default baud rate is 19.2 kbps.

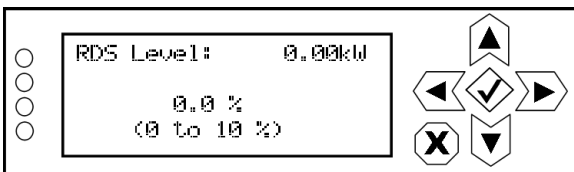

Use the up and down buttons to select a level between 0 and 10% (in 0.1% increments), then press the accept (checkmark) button to save the change. Press the cancel (X) button to discard changes and return to the previous menu. Default level is 0.0%.

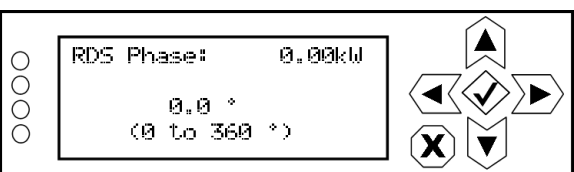

Use the up and down buttons to select a phase angle between 0 and 360 degrees (in 0.1 degree increments), then press the accept (checkmark) button to save the change. Press the cancel (X) button to discard changes and return to the previous menu. Default level is 0.0 degrees.

Figure 3.2.103: RDS Settings editing screens (2 of 3)

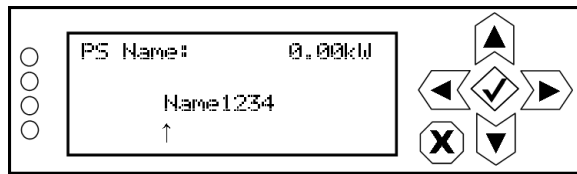

Enter an 8-character name. Use the right and left arrows to move the cursor to the desired character. Use the up and down arrows to edit the character, then press the accept (checkmark) button to save the change. Press the cancel (X) button to discard changes and return to the previous menu.

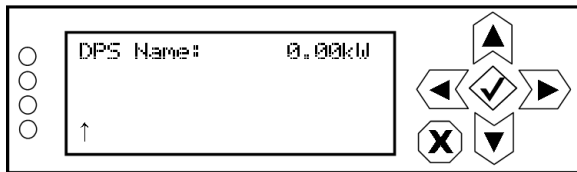

Enter a name. Use the right and left arrows to move the cursor to the desired character. Use the up and down arrows to edit the character, then press the accept (checkmark) button to save the change. Press the cancel (X) button to discard changes and return to the previous menu.

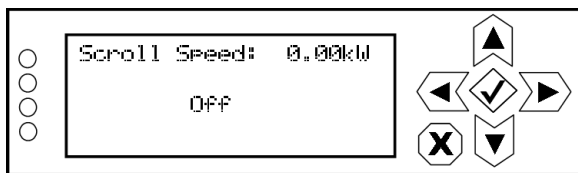

Use the up and down arrows to select Off, Fast or Slow, then press the accept (checkmark) button to save the change. Press the cancel (X) button to discard changes and return to the previous menu. The default selection is Off.

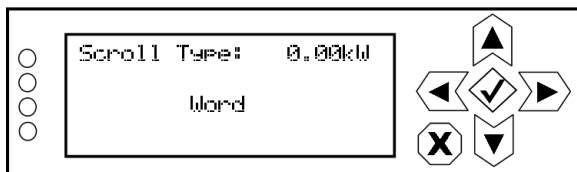

Use the up and down arrows to select Word or Character, then press the accept (checkmark) button to save the change. Press the cancel (X) button to discard changes and return to the previous menu. The default selection is Word.

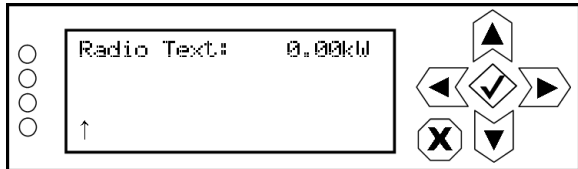

Enter a name. Use the right and left arrows to move the cursor to the desired character. Use the up and down arrows to edit the character, then press the accept (checkmark) button to save the change. Press the cancel (X) button to discard changes and return to the previous menu.



Use the up and down arrows to select a hex value between 0x0000 and 0xFFFF, then press the accept (checkmark) button to save the change. Press the cancel (X) button to discard changes and return to the previous menu. The default hex value is 0x0000.



Use the up and down arrows to select the program type from the various options, then press the accept (checkmark) button to save the change. Press the cancel (X) button to discard changes and return to the previous menu. The default selection is NONE.

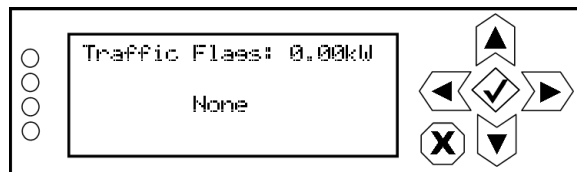

Use the up and down arrows to select None, TA/TP, TP or TA, then press the accept (checkmark) button to save the change. Press the cancel (X) button to discard changes and return to the previous menu. The default selection is NONE.

Figure 3.2.104: RDS Settings editing screens (3 of 3)

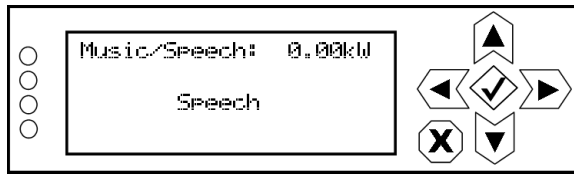

Use the up and down arrows to select Music or Speech, then press the accept (checkmark) button to save the change. Press the cancel (X) button to discard changes and return to the previous menu. The default selection is Speech.

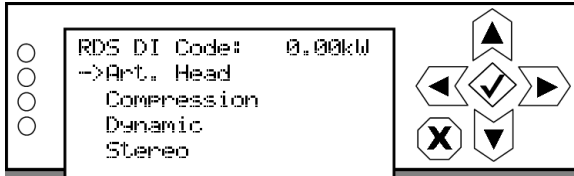

Use the up and down buttons to select the desired parameter for editing. See [Figure 3.2.104 on page 3.2.142](#) for more details. Press the accept (checkmark) button to enter the sub-menu for that parameter. Press the cancel (X) button to return to the previous menu.

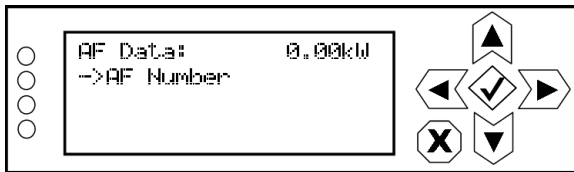

Use the up and down buttons to select AF Number for editing. See [Figure 3.2.106 on page 3.2.143](#) for more details. Press the accept (checkmark) button to enter the sub-menu for that parameter. Press the cancel (X) button to return to the previous menu.

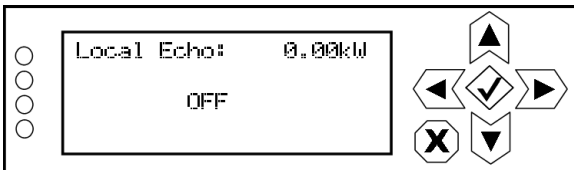

Use the up and down arrows to select ON or OFF, then press the accept (checkmark) button to save the change. Press the cancel (X) button to discard changes and return to the previous menu. The default selection is OFF.

Figure 3.2.105: DI Code editing screens

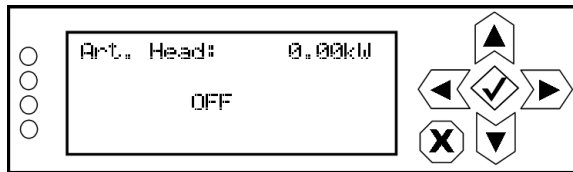

Use the up and down arrows to select ON or OFF, then press the accept (checkmark) button to save the change. Press the cancel (X) button to discard changes and return to the previous menu. The default selection is OFF.



Use the up and down arrows to select ON or OFF, then press the accept (checkmark) button to save the change. Press the cancel (X) button to discard changes and return to the previous menu. The default selection is OFF.

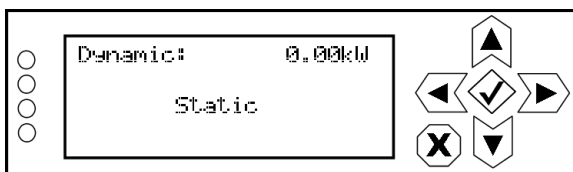

Use the up and down arrows to select Dynamic or Static, then press the accept (checkmark) button to save the change. Press the cancel (X) button to discard changes and return to the previous menu. The default selection is Static.

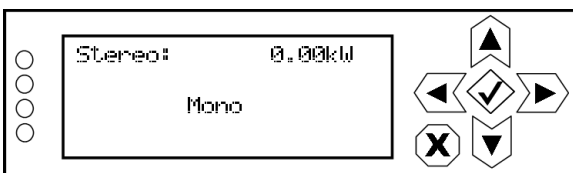

Use the up and down arrows to select Stereo or Mono, then press the accept (checkmark) button to save the change. Press the cancel (X) button to discard changes and return to the previous menu. The default selection is Mono.

Figure 3.2.106: AF Data editing screen

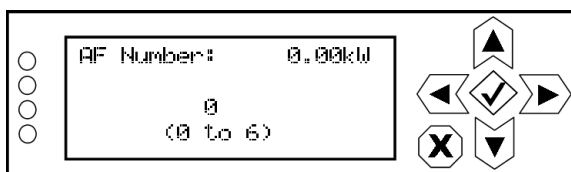

Use the up and down arrows to select the number of alternate frequencies (between 0 and 6), then press the accept (checkmark) button to save the change. Press the cancel (X) button to discard changes and return to the previous menu. The default number is 0.

Limiter Settings

When you select Limiter Settings from the Preset editing options screen, you can edit various limiter parameters (see [Figure 3.2.107](#)).

Figure 3.2.107: Limiter Settings menu

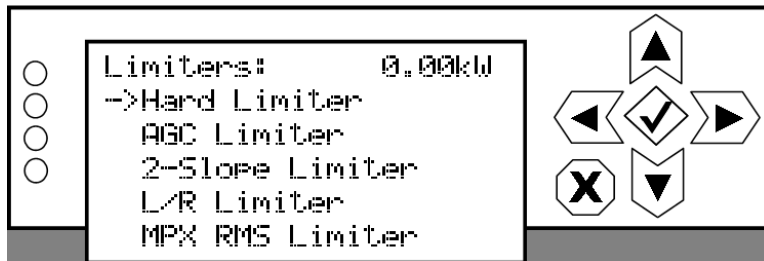

Use the up and down buttons to move the cursor to the desired limiter and then press the right button to enter the associated sub-menu for:

- ❖ Hard Limiter (see [Figure 3.2.108](#) on page 3.2.145)
- ❖ AGC Limiter (see [Figure 3.2.109](#) on page 3.2.145)
- ❖ 2-Slope Limiter (see [Figure 3.2.110](#) on page 3.2.146)
- ❖ L/R Limiter (see [Figure 3.2.111](#) on page 3.2.147)
- ❖ MPX RMS Limiter (see [Figure 3.2.112](#) on page 3.2.148)

Within a sub-menu, use the up and down buttons to move the cursor to the desired limiter setting and then press the right button to enter the associated editing screen. Within any of the editing screens, use the arrow buttons to edit or toggle a parameter value, noting the minimum and maximum limitations indicated at the bottom of the display (as applicable). When complete, press the accept (checkmark) button to save the change. Press the cancel (X) button to discard changes and return to the previous menu.

Figure 3.2.108: Hard Limiter sub-menu and editing screens

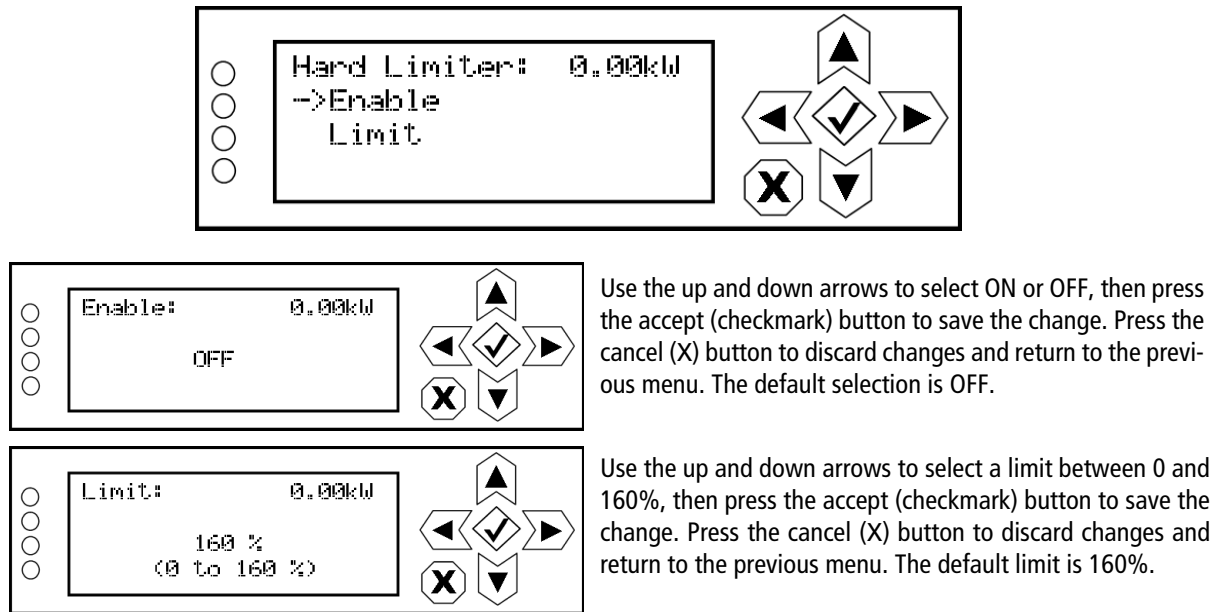

Figure 3.2.109: AGC Limiter sub-menu and editing screens

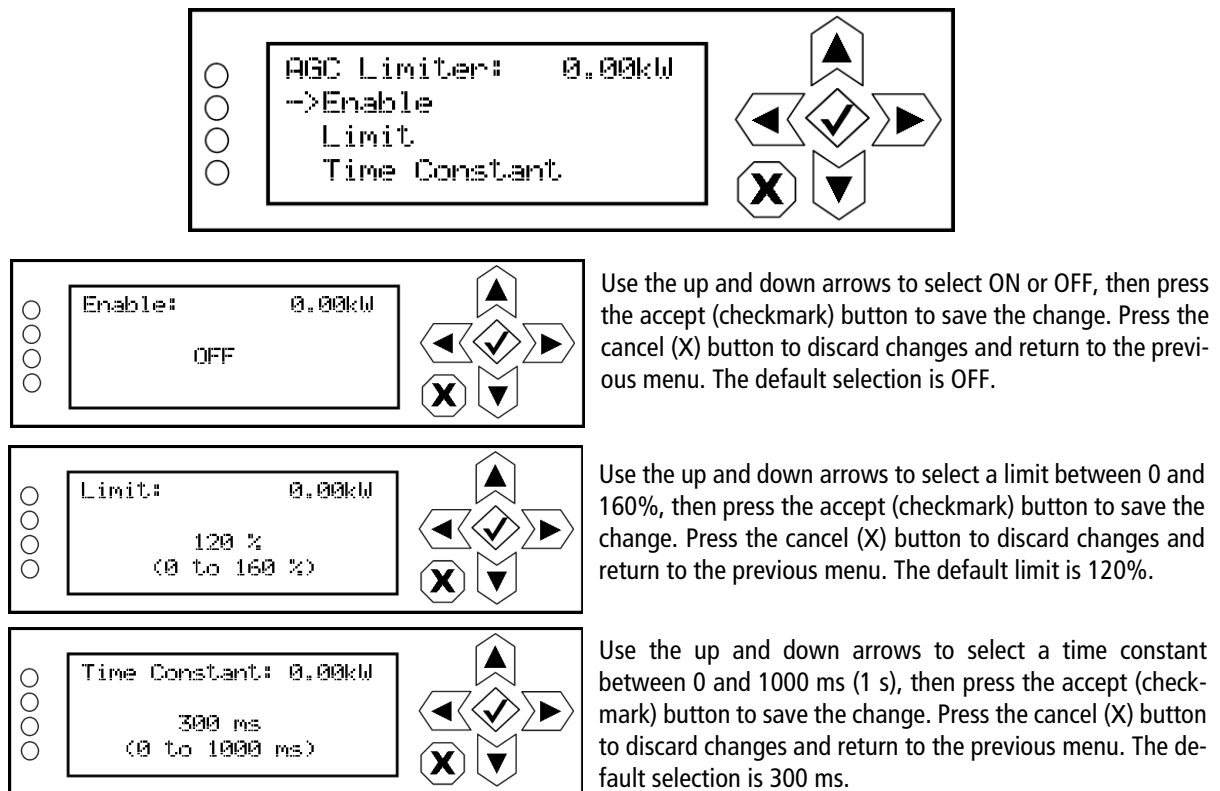

Figure 3.2.110: 2-Slope Limiter sub-menu and editing screens

The figure illustrates the 2-Slope Limiter sub-menu and its editing screens. It consists of four sequential screenshots:

- Top Screenshot:** The main menu for the 2-Slope Limiter. It displays "2-Slope Limite:0.00kW" and three menu items: "→Enable", "Limit", and "Gain". To the right are navigation buttons: up, down, left, right, a checkmark (accept), and an 'X' (cancel).
- Second Screenshot:** The "Enable" editing screen. It shows "Enable: 0.00kW" and "OFF" as the selected option. The same navigation buttons are present.
- Third Screenshot:** The "Limit" editing screen. It shows "Limit: 0.00kW" and "160 % (0 to 160 %)" as the selected option. The same navigation buttons are present.
- Fourth Screenshot:** The "Gain" editing screen. It shows "Gain: 0.00kW" and "50.0 % (0 to 100 %)" as the selected option. The same navigation buttons are present.

Use the up and down arrows to select ON or OFF, then press the accept (checkmark) button to save the change. Press the cancel (X) button to discard changes and return to the previous menu. Default selection is OFF.

Use the up and down arrows to select a limit between 0 and 160%, then press the accept (checkmark) button to save the change. Press the cancel (X) button to discard changes and return to the previous menu. Default limit is 160%.

Use the up and down arrows to select a gain between 0 and 100%, then press the accept (checkmark) button to save the change. Press the cancel (X) button to discard changes and return to the previous menu. Default gain is 50%.

Figure 3.2.111: L/R Limiter sub-menu and editing screens

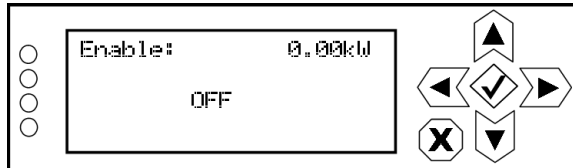
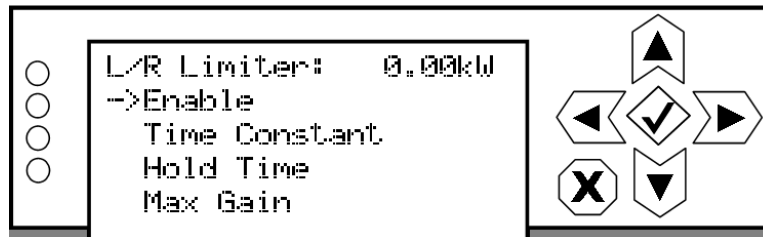

Use the up and down arrows to select ON or OFF, then press the accept (checkmark) button to save the change. Press the cancel (X) button to discard changes and return to the previous menu. Default selection is OFF.

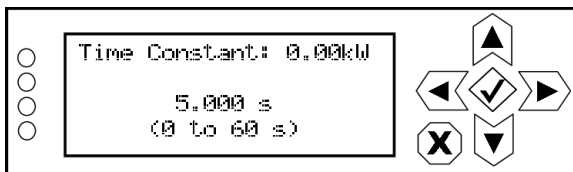

Use the up and down arrows to select a time constant between 0 and 60 s, then press the accept (checkmark) button to save the change. Press the cancel (X) button to discard changes and return to the previous menu. Default time constant is 5.000 s.

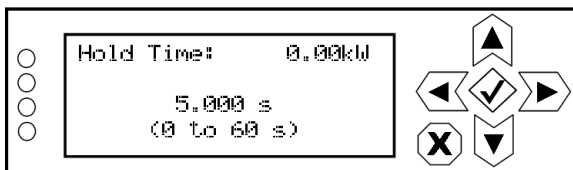

Use the up and down arrows to select a hold time between 0 and 60 s, then press the accept (checkmark) button to save the change. Press the cancel (X) button to discard changes and return to the previous menu. Default hold time is 5.000 s.

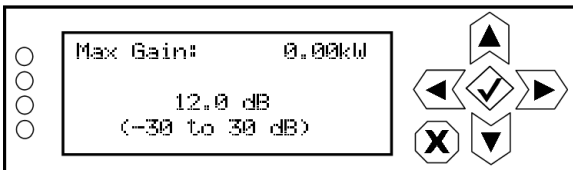

Use the up and down arrows to select a maximum gain between -30 and 30 dB, then press the accept (checkmark) button to save the change. Press the cancel (X) button to discard changes and return to the previous menu. Default gain is 12.0 dB.

Figure 3.2.112: MPX RMS Limiter sub-menu and editing screens

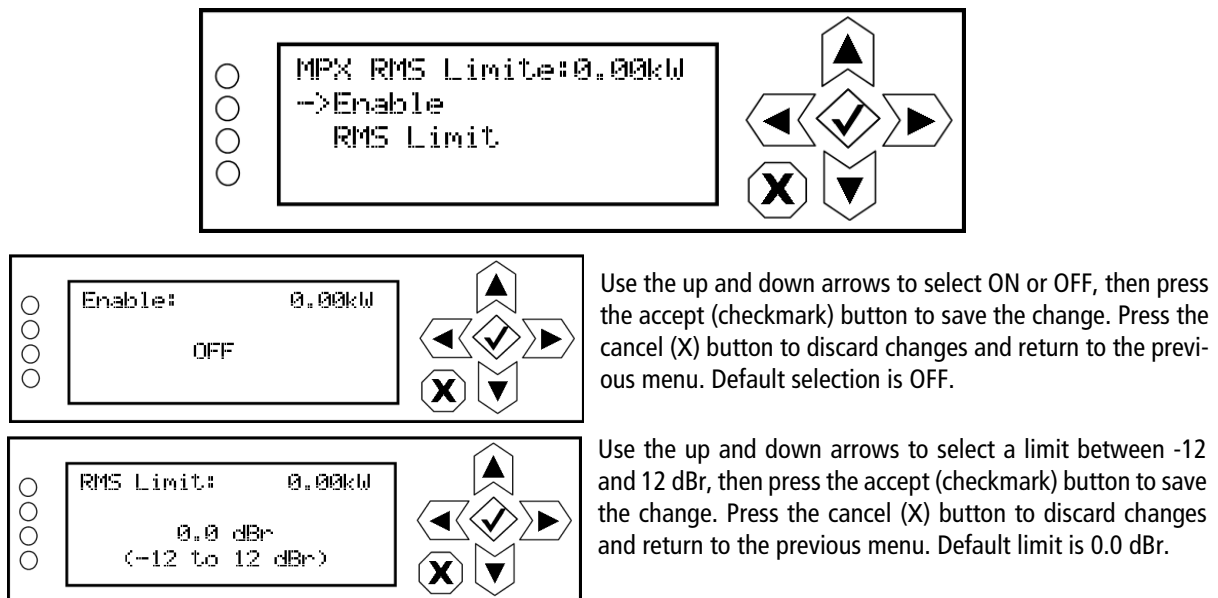

Mod Loss

When you select Mod Loss (modulation loss) from the Preset editing options screen, you can edit the parameters related to a loss of modulation (see [Figure 3.2.113](#)).

Figure 3.2.113: Mod Loss menu

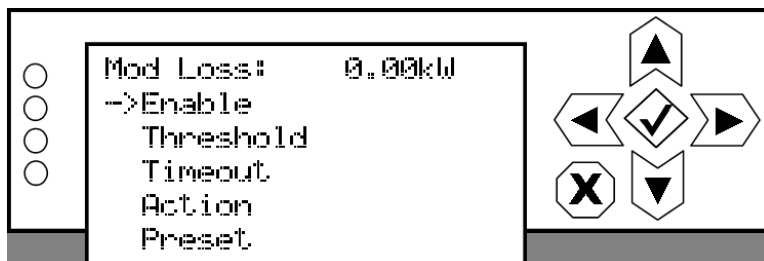

Use the up and down buttons to move the cursor to the desired mod (modulation) loss menu item and then press the right button to enable editing of the item. [Figure 3.2.114 on page 3.2.149](#) shows all the editing screens for the Mod Loss menu. Within any of the editing screens, use the up and down buttons to edit a parameter value, noting the minimum and maximum limitations indicated at the bottom of the display (as applicable). When complete, press the accept (checkmark) button to save the change. Press the cancel (X) button to discard changes and return to the previous menu.

See [Configuring a Mod Loss Backup Preset, on page 3.4.6](#) for detailed instructions.

Figure 3.2.114: Mod Loss editing screens

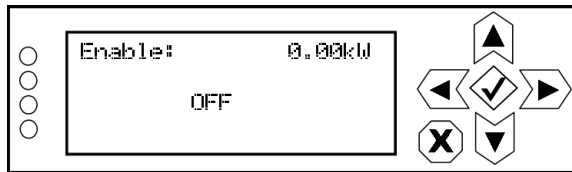

Determines whether the audio loss feature is used. Use the up and down arrows to select ON (enable) or OFF (disable), then press the accept (checkmark) button to save the change. Press the cancel (X) button to discard changes and return to the previous menu. Default selection is OFF.

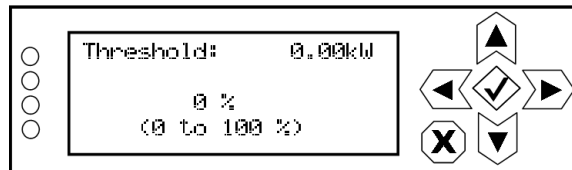

Sets the modulation threshold below which the transmitter will take action. Use the up and down arrows to select a threshold between 0 and 100% (adjustable in 1% steps), then press the accept (checkmark) button to save the change. Press the cancel (X) button to discard changes and return to the previous menu. Default threshold is 0%.

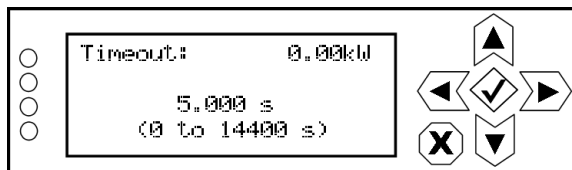

Sets the time period of low modulation (based on the threshold setting) after which the transmitter will take action. Use the up and down arrows to select a value between 0 and 14400 seconds (240 minutes) (in 0.05 s increments), then press the accept (checkmark) button to save the change. Press the cancel (X) button to discard changes and return to the previous menu. Default timeout is 0 s.

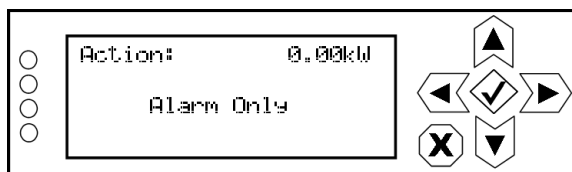

Determines the action taken by the transmitter when the modulation has been below the threshold for the timeout period. Use the up and down arrows to select Alarm Only, Switch Preset or RF Inhibit, then press the accept (checkmark) button to save the change. Press the cancel (X) button to discard changes and return to the previous menu. Default setting is Alarm Only.

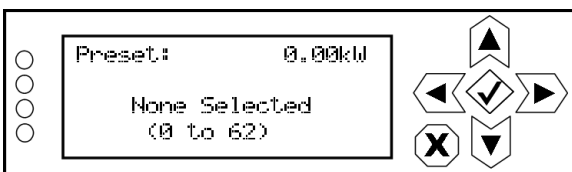

Determines the preset that becomes active after a modulation loss if the mod loss action is set to Switch Preset. Use the up and down arrows to select None Selected or Preset 1 to 62, then press the accept (checkmark) button to save the change. Press the cancel (X) button to discard changes and return to the previous menu. Default setting is None Selected.

Audio Delay

When you select Audio Delay from the Preset editing options screen, you can edit or disable the audio delay period (see [Figure 3.2.115](#)).

Figure 3.2.115: Audio Delay menu

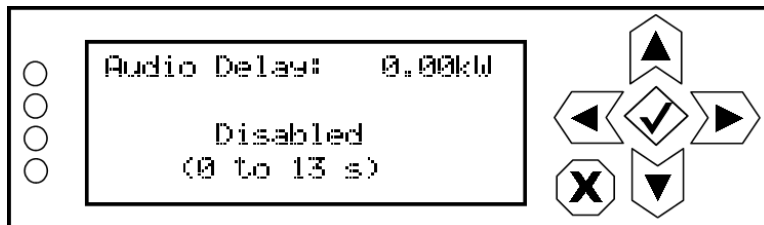

Use the up and down buttons to change the audio delay setting between disabled (= 0 s) and any time period to a maximum of 13 seconds (in 1 us steps), then press the accept (checkmark) button to save the change. Press the cancel (X) button to discard changes and return to the previous menu.

Copy Another Preset

When you select Copy Another Preset from the Preset editing options screen, you can copy the settings from another preset into the preset that is being edited (see [Figure 3.2.116](#)).

Figure 3.2.116: Copy Another Preset Screen

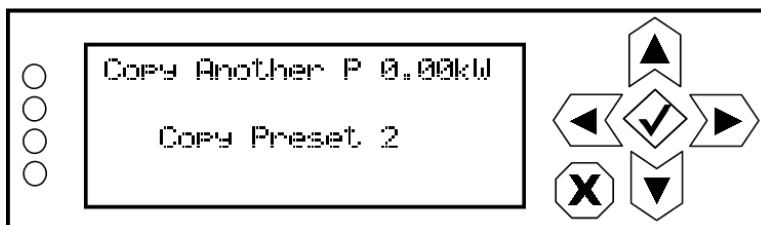

Use the up and down buttons to select the preset that you wish to copy to the selected preset for editing (e.g., Copy Active Preset, Copy Preset 2, etc.) or select Cancel. Press the accept (checkmark) button to save the change. Press the cancel (X) button to discard changes and return to the previous menu.

Setting the Clock

When you select User Settings -> Set Clock from the Main Menu (see [Figure 3.2.117](#)) you can set the current time and date. The time appears on the top line of the top level screen (see [Figure 3.2.80](#) on [page 3.2.118](#)).

Figure 3.2.117: Set Clock screen

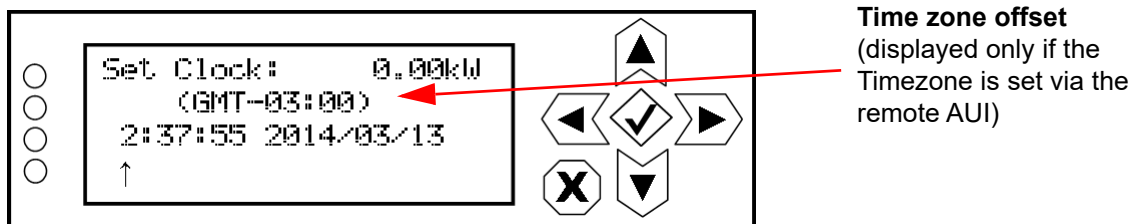

To change the time or date, use the right and left arrow buttons to move the cursor to the desired field (hours, minutes, seconds, year, month, day), and use the up and down arrow buttons to increase or decrease the value of the selected field as desired. When complete, press the accept (checkmark) button to save the change. Press the cancel (X) button to discard changes and return to the previous menu.

The time zone offset line (e.g., GMT-03:00) appears only if the Timezone has been established in the remote AUI's Time Setup page.

Network Setup

From the controller's UI, in local mode, you can set or change network settings. To view the Network Settings screen, select User Settings -> Network Settings from the Main Menu. See [Figure 3.2.118 on page 3.2.153](#) for details on setting each parameter.

Use the up and down buttons to move the cursor to the desired parameter and then press the right button to enable editing of the setting. Within any of the editing screens, use the left and right buttons to select a character for editing and then use the up and down buttons to edit a setting. Press the accept (checkmark) button to save the change. Press the cancel (X) button to discard changes and return to the previous menu.

NOTE: A nameserver (also called a DNS) translates a host name (e.g., mail.nautel.com) to an IP address such as in configuring email (see [Email Server, on page 3.2.86](#)).

If you are using a laptop to connect to the GV2-10/GV2-7.5, see [Connecting a Laptop Directly to the Transmitter, on page 3.2.154](#).

Figure 3.2.118: Network Settings screens

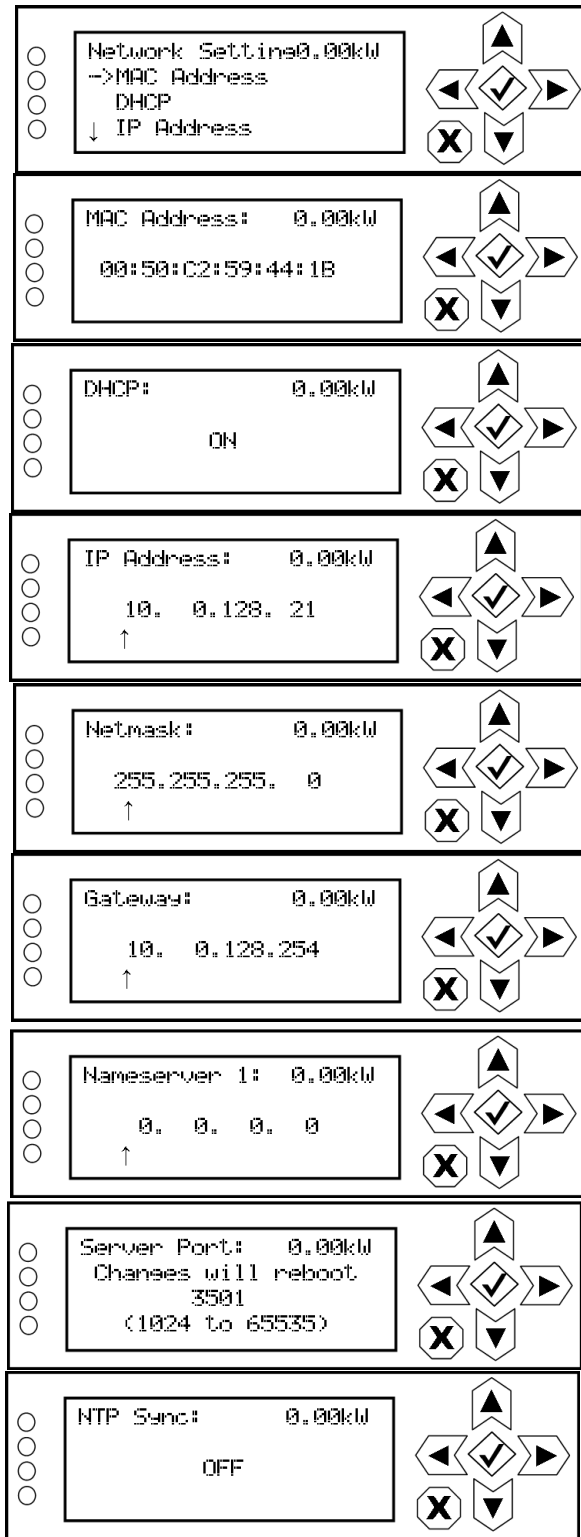

All addresses shown are for reference purposes only

Displays a number that serves as unique network adapter identifier. This is set by the manufacturer and is displayed for informational purposes only (cannot be user set). It may be necessary to use this number to allow the AUI to access your network.

Set to ON to automatically assign the IP Address, Netmask, Gateway, Nameserver 1 and Nameserver 2 by the access point (i.e., a router) or set to OFF to manually assign. In either case, the access point must be configured with the correct settings, which match the settings on the AUI in order for the AUI to access the network.

Displays a unique numerical network identifier for the transmitter. If DHCP was set to OFF, specify the IP address. Consult with your network administrator.

Masks an IP address, and divides the IP address into network address and host address. If DHCP was set to OFF, specify netmask. Typical netmask address shown. Consult with your network administrator.

Defines the address of the network access point. If DHCP was set to OFF, specify the gateway address. Consult with your network administrator.

Address that identifies the DNS host. The DNS (Domain Name System) translates internet domain and host names to IP addresses. DNS automatically converts the name typed into a web browser address bar to the IP addresses of web servers hosting those sites. If DHCP is set to OFF, specify the address.

Used to identify the senders and receivers of messages. Also supports port forwarding (remapping) which allows the AUI of multiple transmitters to be accessed on the same network. See your network router documentation for additional remapping information and instructions. NOTE: Changes to this port are reset to 3501 after a software upgrade; reconfigured the port, as required, after an upgrade.

NTP = Network Time Protocol.
Set to ON to allow the network to synchronize to the transmitter time.
Set to OFF to use the transmitter's internal time reference.

Connecting a Laptop Directly to the Transmitter

If connecting to the GV2-10/GV2-7.5 directly with a laptop, you must set a static IP address on the GV2-10/GV2-7.5 and your laptop.

1. From the controller UI's Main Menu, go to User Settings -> Network Settings and set the IP address as follows:
 - ❖ DHCP: OFF
 - ❖ IP Address: 10.10.10.2
 - ❖ Netmask: 255.255.255.0

2. Set the transmitter for Remote control.

NOTE: The following steps assume the operating system is Windows XP. Adapt as required for computers with different operating systems.

3. On the laptop, go to Start Menu/Control Panel/Network Connections/Local Area Network.
4. In the Local Area Network Status, open the General tab and choose Properties. Scroll down and highlight Internet Protocol (TCP/IP). Choose Properties.
5. In the Internet Protocol (TCP/IP) Properties window, select Use the following IP address.
6. Enter the following settings:
 - ❖ IP Address: 10.10.10.1
 - ❖ Subnet Mask: 255.255.255.0
 - ❖ Default Gateway: 192.168.1.2
7. In the Internet Protocol (TCP/IP) Properties window, select OK.
8. In the Local Area Connection Properties window, select OK.
9. In the Local Area Connection Status window, select Close.
10. Close the Network Connections window.
11. Enter the IP address (10.10.10.2) into a web browser's address bar to connect to the transmitter's remote AUI.

Setting Pilot Sample Level

NOTE: Setting the pilot sample is only available using the controller UI.

From the controller front panel UI, you can set the level of the pilot sample that is applied to the PILOT SAMPLE OUT (A1J4A) BNC connector on the rear of the controller (A4). To view the Pilot Sample screen, select User Settings -> Pilot Sample from the Main Menu (see [Figure 3.2.119](#)).

Figure 3.2.119: Pilot Sample Screen

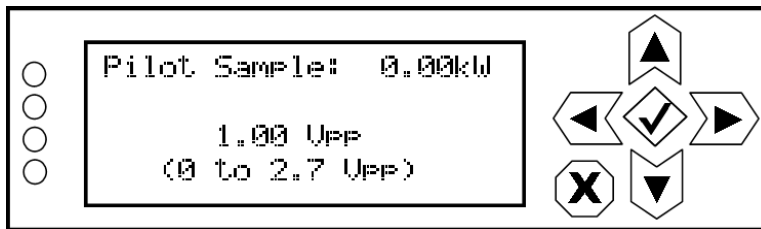

Use the up and down buttons to edit the pilot sample level between 0 and 2.70 V peak-to-peak (in 0.01 V increments). Press the accept (checkmark) button to save the change. Press cancel (X) to discard changes and return to the previous menu.

Configure Test Signal Generator

NOTE: The test signal generator function is only available using the controller UI.

From the controller UI, you can configure the test signal generator output of the GV2-10/GV2-7.5. Note that a different menu will appear depending on the currently configured test signal type. To view the Signal Gen screen, select User Settings -> Signal Gen from the Main Menu (see [Figure 3.2.120](#)).

Figure 3.2.120: Signal Generator Menus

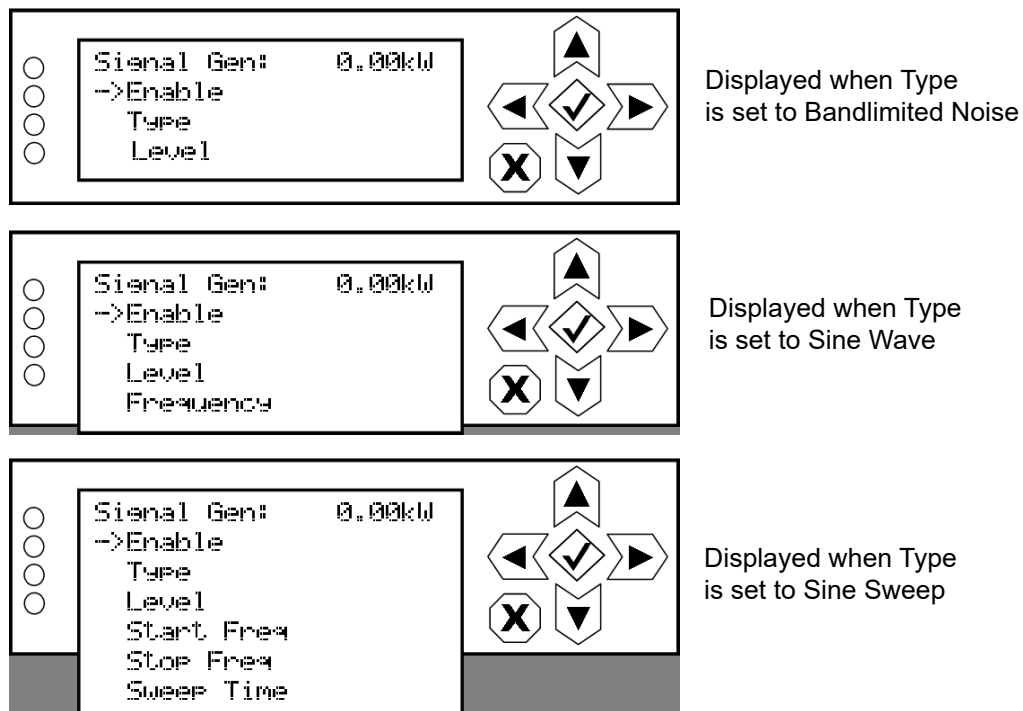

Use the up and down buttons to move the cursor to the desired line item and then press the right button to enable editing.

[Figure 3.2.121 on page 3.2.157](#) shows all possible editing screens for the Signal Gen menu. Within any of the editing screens, use the up and down buttons to edit the setting. Press the accept (checkmark) button to save the change. Press cancel (X) to discard changes and return to the previous menu.

Figure 3.2.121: Signal Generator Editing Screens

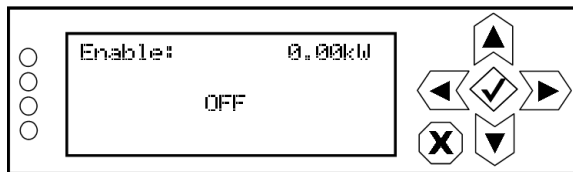

Select ON (enabled) or OFF (disabled). Press the cancel (X) button to discard changes and return to the previous menu. Default is OFF.

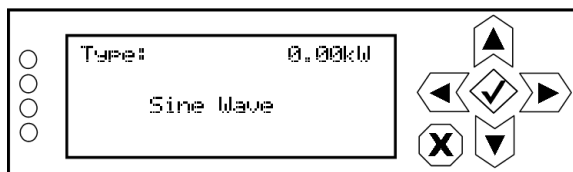

Select a type - None, Sine Wave, Sine Sweep or Bandlimited Noise. Press the cancel (X) button to discard changes and return to the previous menu.

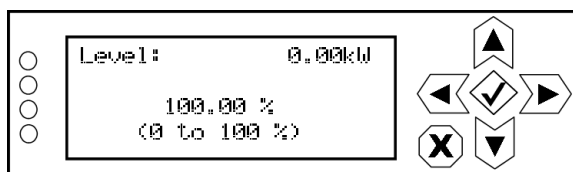

Select a level between 0 and 100%. Press the cancel (X) button to discard changes and return to the previous menu. Default is 100%.

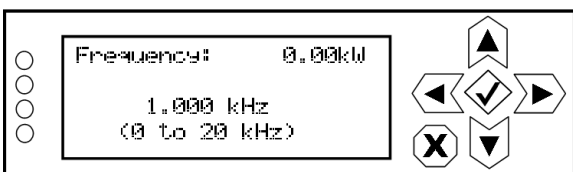

When Type is set to Sine Wave, select a frequency between 0 and 20 kHz. Press the cancel (X) button to discard changes and return to the previous menu. Default is 1 kHz.

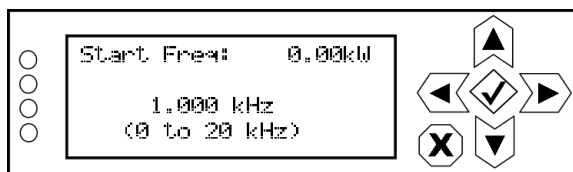

When Type is set to Sine Sweep, select a start frequency between 0 and 20 kHz. Press the cancel (X) button to discard changes and return to the previous menu. Default is 1 kHz.

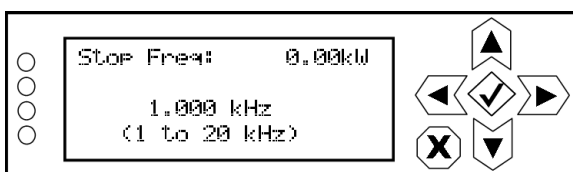

When Type is set to Sine Sweep, select a stop frequency between 1 and 20 kHz. Press the cancel (X) button to discard changes and return to the previous menu. Default is 1 kHz.

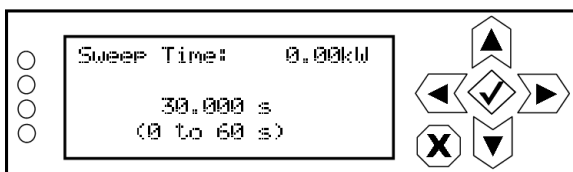

When Type is set to Sine Sweep, select a time between 0 and 60 s. Press the cancel (X) button to discard changes and return to the previous menu. Default is 30 s.

External 10 MHz Input

To view the enable/disable screen for the external 10 MHz input (see [Figure 3.2.122](#)), select User Settings -> Ext. 10 MHz Inp from the Main Menu.

Figure 3.2.122: Front Panel - External 10 MHz Input screen

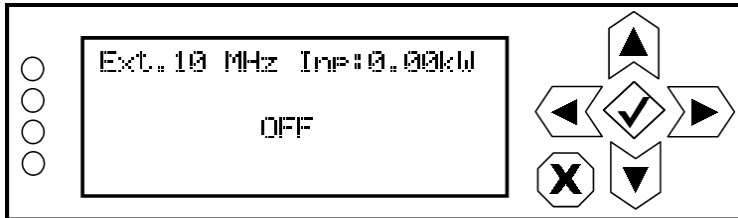

Use the up or down arrow to toggle between ON (using external 10 MHz input) and OFF (not using external 10 MHz input), then press the accept (checkmark) button to save the change. Press cancel (X) to discard changes and return to the previous menu.

Enabling the Scheduler

To view the Scheduler enable/disable screen (see [Figure 3.2.123](#)) on the controller front panel display, select User Settings -> Scheduler from the Main Menu.

Figure 3.2.123: Enabling/disabling the scheduler - Front Panel

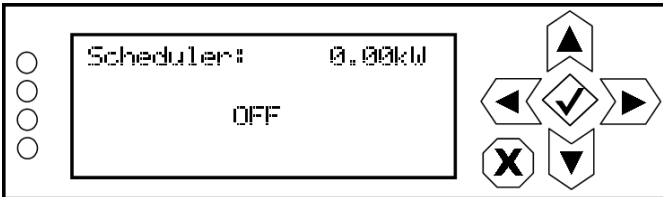

Use the up and down buttons to select ON (enable) or OFF (disable). The default setting is OFF. Press cancel (X) to return to the previous menu.

Selecting FM Mask

NOTE: FM Mask selection is only available using the controller UI.

From the controller UI, you can select the appropriate FM mask standard (FCC, ETSI or None) being used by the analyzer on the AUI. The selection affects the mask lines on the AUI's Spectrum Analyzer instrument. To view the FM Mask screen, select User Settings -> FM Mask from the Main Menu (see [Figure 3.2.124](#)).

Figure 3.2.124: FM Mask Screen

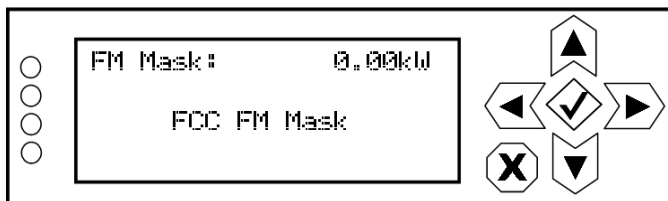

Use the up and down buttons to toggle between FCC FM Mask, ETSI FM Mask and No FM Mask. The factory setting is FCC FM Mask. Press the accept (checkmark) button to save the change. Press cancel (X) to discard changes and return to the previous menu.

Setting User Thresholds

From the controller UI, you can establish the low audio thresholds and timeout delays for the main audio and SCAs. To view the Audio Low screen, select User Settings -> Audio Low from the Main Menu (see [Figure 3.2.125](#)).

Figure 3.2.125: Audio Low Menu

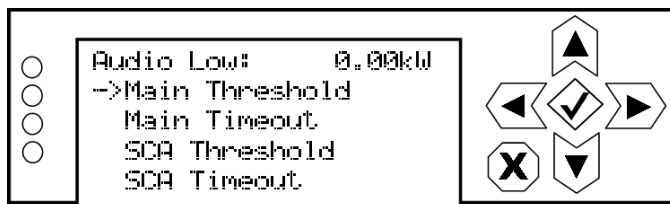

Use the up and down buttons to move the cursor to the desired line item and then press the right button to enable editing. [Figure 3.2.126](#) shows all possible editing screens for the Audio Low menu. Within any of the editing screens, use the up and down buttons to edit the setting. Press the accept (checkmark) button to save the change. Press cancel (X) to discard changes and return to the previous menu.

Figure 3.2.126: Audio Low Editing Screens

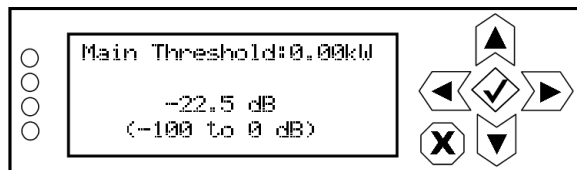

Select a level between -100 and 0 dB (in 0.5 dB increments). Press the cancel (X) button to discard changes and return to the previous menu. Default setting is -22.5 dB.

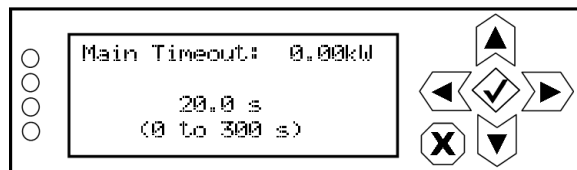

Select a timeout between 0 and 300 s (5 minutes) (in 0.5 s increments). Press the cancel (X) button to discard changes and return to the previous menu. Default setting is 20 s.

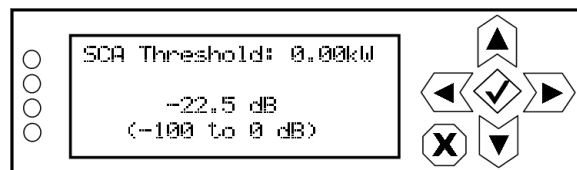

Select a level between -100 and 0 dB (in 0.5 dB increments). Press the cancel (X) button to discard changes and return to the previous menu. Default setting is -22.5 dB.

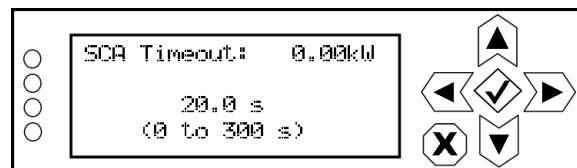

Select a timeout between 0 and 300 s (5 minutes) (in 0.5 s increments). Press the cancel (X) button to discard changes and return to the previous menu. Default setting is 20 s.

Turn-On Delay Setting

NOTE: The turn-on delay setting is only available using the controller UI.

From the controller UI, you can set the transmitter's turn-on delay. This setting determines the time delay for the transmitter to recover from an ac power loss. This is typically used in sites with multiple transmitters on a common generator. By staggering the turn-on delay periods of each transmitter, you can reduce the overall load on the generator. To view the Turn On Delay screen, select User Settings -> Turn On Delay from the Main Menu (see [Figure 3.2.127](#)).

Figure 3.2.127: Turn On Delay Screen

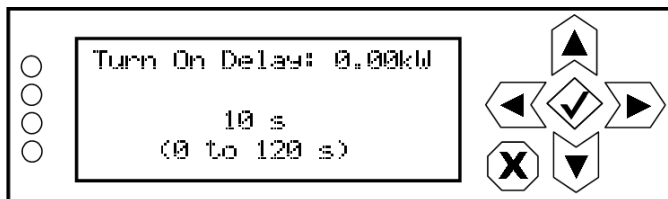

Use the up and down buttons to select a delay between 0 and 120 s (in 1 s increments). The default setting is 0 s (disabled). Press the accept (checkmark) button to save the change. Press X to abort the reset and return to the previous menu.

Ramp-Up Speed Setting

NOTE: The ramp-up speed setting is only available using the controller UI.

From the controller UI, you can set the transmitter's ramp-up speed. This setting establishes the time it takes the transmitter to ramp up from 0 W to full power. At 100%, ramp-up speed is approximately seven seconds. For a setting of 50%, ramp-up would be approximately 14 seconds. For a setting of 25%, ramp-up would be approximately 28 seconds. In multi-transmitter systems that are on a common generator or power grid, adjusting the ramp-up speed can be used to reduce the transient load on the source during an ac power recovery (i.e., after a power failure or changeover to a generator).

To view the Ramp-up Speed screen, select User Settings -> Ramp-up Speed from the Main Menu (see [Figure 3.2.128](#)).

Figure 3.2.128: Ramp-up Speed Screen

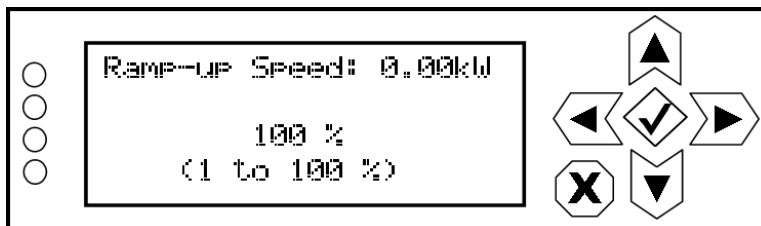

Use the up and down buttons to select a ramp-up speed between 1 and 100% (in 1% increments), noting 100% represents approximately seven seconds (0 W to full power). The default setting is 100% (approximately Press the accept (checkmark) button to save the change. Press X to abort the reset and return to the previous menu.

View Status

View Alarms

When you select View Status -> View Alarms or View Status -> View Log from the Main Menu (see [Figure 3.2.129](#)), you can view various active or logged events, respectively, of the GV2-10/GV2-7.5. These parameters are likely displayed on multiple pages and require that you scroll to view all of them.

NOTE: This screen is for viewing purposes only and does not offer the same level of analytical features as the AUI's Logs page (see [View Status on page 3.2.164](#)).

Figure 3.2.129: View Alarms and View Logs Screens

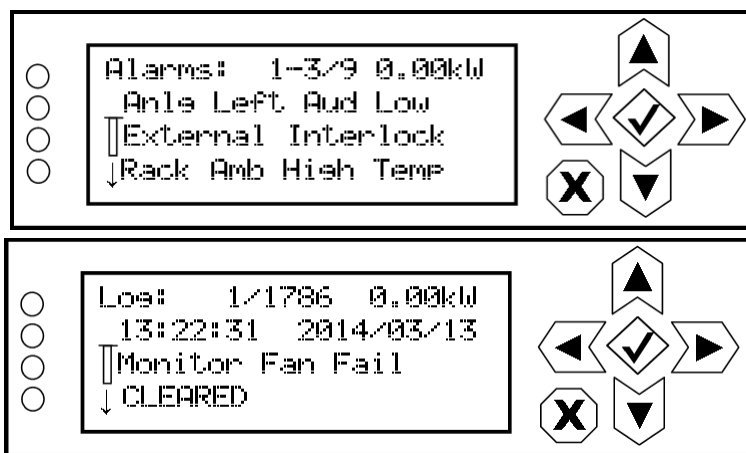

The View Alarms screen displays only alarms that are currently active. Older alarms that have cleared may still be present in the View Log screen.

Use the up and down buttons to scroll through the list of alarms or logged events.

Refer to the GV2-10/GV2-7.5 Troubleshooting Manual to cross-reference the alarm name to possible causes and troubleshooting tips.

When you select Clear Log from the View Status menu, you will delete all logged events.

NOTE: Clearing the controller front panel UI's logs does not clear the logs displayed in the remote AUI.

Use the Reset Alarms command in the controller front panel UI's Main Menu -> Reset Alarms screen to attempt to clear any latching alarms that are holding the transmitter in an "off-air" state. If the offending alarm has cleared, the transmitter should resume operation. See [Setting Pilot Sample Level, on page 3.2.155](#).

View Meters

When you select View Status -> View Meters from the Main Menu (see [Figure 3.2.130](#)) you can view various metered parameters of the GV2-10/GV2-7.5. These parameters are divided into sections. When you select a particular section, the applicable meters are displayed as a list on the appropriate screen.

NOTE: The View Meters screens are for viewing purposes only and do not offer the same level of analytical features as the AUI's Meter List View page (see [Meters on page 3.2.37](#)).

Figure 3.2.130: View Meters Screens

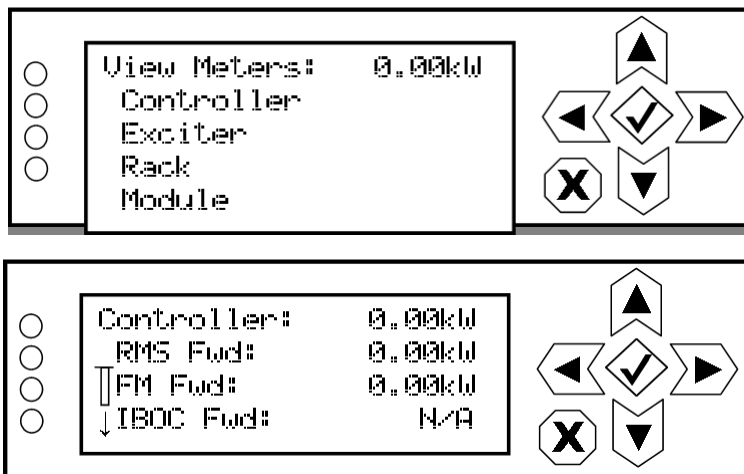

Controller screen shown,

See the tables on the following pages for full list of meters available for Controller, Exciter, Rack and RF Module sections.

Use the up and down buttons to scroll through the meter sections. Press the accept (checkmark) button to enter the meters screen for that section (see [Controller: on page 3.2.166](#)). Use the up and down buttons to scroll through the list of metered parameters one at a time and use the right arrow to 'page down' through the list of metered parameters, noting that the parameters in the following tables are available for viewing.

NOTE: In the RF Module meter screen, pressing the checkmark button will change the sorting of the PM meters. For example: normally the meters are displayed for PM1, then PM2, etc. When you press checkmark, the meters sort by parameter (e.g., PM1 PA Voltage A, PM2 PA Voltage A, etc.) to allow easier viewing of a specific parameter for all RF modules.

Controller:

RMS Forward Power	Reject 3-4 Power	Reject 17-32 Power, as applicable
FM Forward Power	Reject 5-6 Power, as applicable	Reject 1-24 Power, as applicable
IBOC Forward Power	Reject 7-8 Power, as applicable	Reject 1-32 Power, as applicable
Reflected Power	Reject 9-10 Power, as applicable	Splitter Fan 1 Speed
VSWR	Reject 11-12 Power, as applicable	Splitter Fan 2 Speed
RF Output Return Loss	Reject 13-14 Power, as applicable	Splitter Fan 3 Speed, as applicable
DC Power In	Reject 15-16 Power, as applicable	Splitter Fan 4 Speed, as applicable
DC-RF Efficiency	Reject 17-18 Power, as applicable	Reject 5kW Fan1 Speed
RF Power Per PA	Reject 19-20 Power, as applicable	Reject 5kW Fan2 Speed
Avg. PA Volts	Reject 21-22 Power, as applicable	Reject 5kW Fan3 Speed
Avg PS Current	Reject 23-24 Power, as applicable	Reject 5kW Fan4 Speed
Total PA Current	Reject 25-26 Power, as applicable	Reject 5kW Fan5 Speed
Avg. PA Dissipated Power	Reject 27-28 Power, as applicable	Reject 5kW Fan6 Speed
PWB Temperature	Reject 29-30 Power, as applicable	Reject 5kW Fan7 Speed, as applicable
Fan Speed	Reject 31-32 Power, as applicable	Reject 5kW Fan8 Speed, as applicable
LVPS Voltage	Reject 1-4 Power	Reject 5kW Fan9 Speed, as applicable
Battery Voltage	Reject 5-8 Power, as applicable	Reject 5kW Fan10 Speed, as applicable
+15V	Reject 9-12 Power, as applicable	Reject 5kW Fan11 Speed, as applicable
+12V A	Reject 13-16 Power, as applicable	Reject 5kW Fan12 Speed, as applicable
+12 V B	Reject 17-20 Power, as applicable	Reject 10kW Fan1 Speed
+5V	Reject 21-24 Power, as applicable	Reject 10kW Fan2 Speed
+3.3V	Reject 25-28 Power, as applicable	Reject 10kW Fan3 Speed
+1.8V	Reject 29-32 Power, as applicable	Reject 10kW Fan4 Speed, as applicable
+1.2V	Reject 1-8 Power, as applicable	Reject 10kW Fan5 Speed, as applicable
RF Drive Power	Reject 9-16 Power, as applicable	Reject 10kW Fan6 Speed, as applicable
RF Drive 1-12 Power, as applicable	Reject 13-20 Power, as applicable	Reject Final Fan1 Speed
RF Drive 13-24 Power, as applicable	Reject 17-24 Power, as applicable	Reject Final Fan2 Speed
RF Drive 17-24 Power, as applicable	Reject 25-32 Power, as applicable	Reject Final Fan3 Speed
RF Drive 25-32 Power, as applicable	Reject 1-12 Power, as applicable	Reject Final Fan4 Speed, as applicable
Total Reject Power	Reject 13-24 Power, as applicable	Reject Final Fan5 Speed, as applicable
Reject 1-2 Power	Reject 1-16 Power, as applicable	Reject Final Fan6 Speed, as applicable

Exciter (A/B, as applicable):

Exc Fwd Power	Exc -15V	Dig 2 R Level
Exc Refl Power	Exc +5V_A	MPX SCA Level
Exc PA VSWR	Exc +5V_B	MPX RMS %
Exc PA Voltage	Exc +3.3V	AGC Limit %
Exc PA Current	Exc +1.8V	MPX Limit %
Exc PA Bias Voltage	Exc +1.2V	Delta 10 MHz
Exc PA Dissipation	Exc Battery Voltage	DAC Gain %
Exc Preamp Voltage	Exc Peak Mod %	Forward Attenuation
Exc Preamp I (current)	Bal L Level	Reverse Attenuation
Exc Preamp Bias Voltage	Bal R Level	Reverse Gain
Exc Fan Voltage	MPX Level	Mask Delta
Exc Fan Speed	Int SCA1 Level	Exc Tilt
Exc PA Temp	Int SCA2 Level	Exc Data MER
Exc PWB Temperature	Dig 1 L Level	Exc Ref MER
Exc LVPS	Dig 1 R Level	Exc 10 MHz Delta (ppm)
Exc +15V	Dig 2 L Level	

Rack # (1 through 8, as applicable):

Rk +15V	Rk LVPS
Rk +5V	Rk Ambient Temperature
Rk +3.3V	Rk Reject Fan Voltage

RF Module (PM1, repeat for PM2 THROUGH PM4):

PM1 Drive Power	PM1 PS A Input Voltage	PM1 Temperature
PM1 PA Voltage A	PM1 PS B Input Voltage	PM1 PS A Voltage
PM1 PA Voltage B	PM1 PS A Input Current	PM1 PS B Voltage
PM1 PA 1 Curr	PM1 PS B Input Current	PM1 PS A Current
PM1 PA 2 Curr	PM1 Fan Voltage	PM1 PS B Current
PM1 PA 3 Curr	PM1 Fan 1 Speed	PM1 PS A Fan Speed
PM1 PA 4 Curr	PM1 Fan 2 Speed	PM1 PS B Fan Speed
PM1 Bias 1 Voltage	PM1 Fan 3 Speed	PM1 PS A Temperature
PM1 Bias 2 Voltage	PM1 Fan 4 Speed	PM1 PS B Temperature
PM1 Bias 3 Voltage	PM1 Fan 5 Speed	PM1 PS A Run Time
PM1 Bias 4 Voltage	PM1 Fan 6 Speed	PM1 PS B Run Time
PM1 Reject Power	PM	

Reset Alarms

You can attempt to reset any latching transmitter alarms that are holding the transmitter in an “off-air” state using the remote AUI’s Reset button (see [Reset Alarms, on page 3.2.168](#)) or using the controller’s UI display.

When you select Reset Alarms from the Main Menu, you can attempt to reset latched protection circuits in the GV2-10/GV2-7.5 (see [Figure 3.2.131](#)). If the alarm condition has been cleared, the alarm indication on the View Alarms screen should disappear.

Figure 3.2.131: Reset Alarms Screen

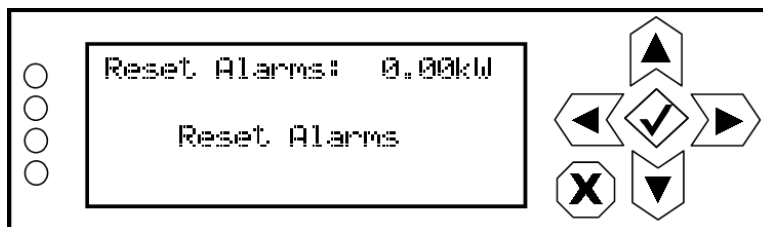

Use the up and down buttons to toggle between Reset Alarms and Cancel. Press the accept (checkmark) button to save the change. Press the cancel (X) button to return to the previous menu.

Exciter Changeover Settings

From the controller UI, you can set the active exciter, main exciter, auto changeover status, changeover delay and exciter configuration. To view the Changeover screen, select System Settings -> Changeover from the Main Menu (see [Figure 3.2.132](#)).

NOTE: In order to edit any changeover settings, the transmitter must be configured for Dual Exciter (A/B) in the controller front panel UI's Installed Exc screen (see [Installed Exciter, on page 3.2.179](#)).

Figure 3.2.132: Changeover Menu

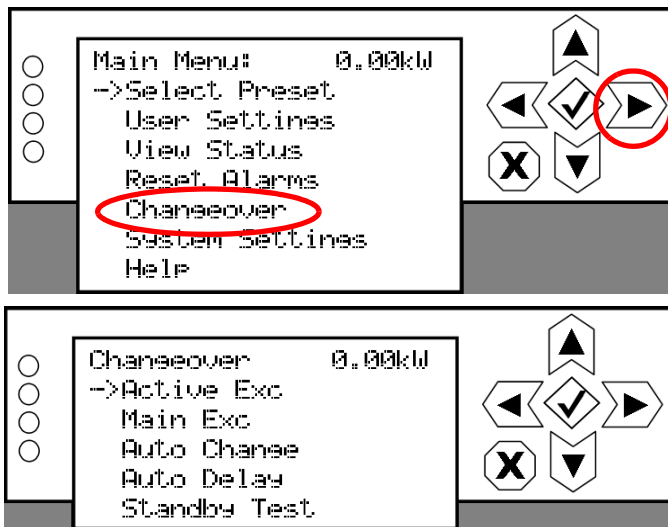

This menu has five sub-menu options. Use the up and down buttons to move the cursor to the desired display setting and then press the right button to enable editing of the setting. [Figure 3.2.133 on page 3.2.170](#) shows the editing screens for the Changeover menu. Within any of the editing screens, use the up and down buttons to edit a setting. Press the accept (checkmark) button to save the change. Press cancel (X) to discard changes and return to the previous menu.

WARNING! Before using the Standby Test function, make sure that the standby exciter's RF output is being applied to a suitably rated test load.

Figure 3.2.133: Changeover Editing Screens

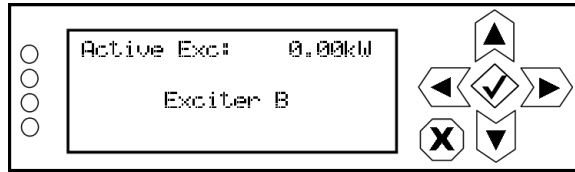

For display only. Indicates the active exciter - Exciter A or Exciter B. Press the cancel (X) button to return to the previous menu.

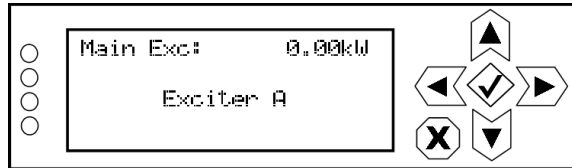

Allows user to set the transmitter's main exciter to Exciter A or Exciter B. Typically, the main exciter is the exciter that operates until an automatic changeover occurs. The default setting is Exciter A. Press the cancel (X) button to discard changes and return to the previous menu.

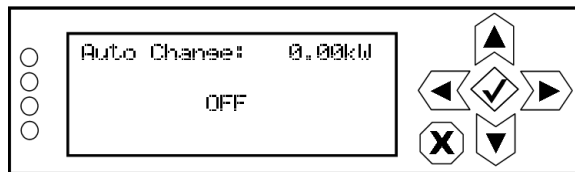

Configures the transmitter to enable (ON) or disable (OFF) automatic exciter changeover. Changeover to the standby exciter occurs if the current/active exciter experiences a fault that inhibits its operation. Press the cancel (X) button to discard changes and return to the previous menu.

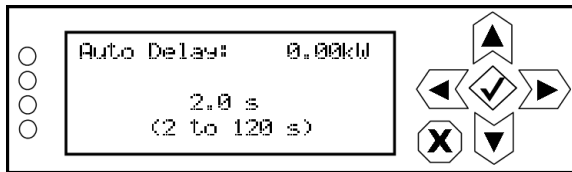

Sets the delay period after which an automatic changeover will occur to a value between 2 and 120 seconds (in 0.1 s increments). Default value is 2 s. Press the cancel (X) button to discard changes and return to the previous menu.

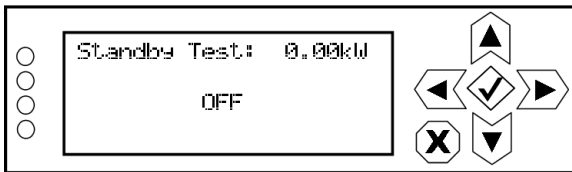

Configures the transmitter to enable (ON) or disable (OFF) the standby exciter's RF power stage to allow testing into a user provided dummy load. When enabled (ON), the exciter will operate at 100 W (ensure the test load is suitably rated). While enabled, auto exciter changeover is disabled (regardless of configuration status). Press the cancel (X) button to discard changes and return to the previous menu.

System Settings

WARNING! System settings are established at Nautel and should not require any adjustment. Making changes to these settings may void your warranty. Contact Nautel before making changes.

You can perform the following functions using the System Settings menu of the controller UI:

- [Host Reboot - see page 3.2.172](#)
- [Host Watchdog - see page 3.2.172](#)
- [Firmware Update - see page 3.2.173](#)
- [LCD Settings - see page 3.2.173](#)
- [Exciter TCXO - see page 3.2.175](#)
- [HD Optimizer - see page 3.2.176](#)
- [HW Config - see page 3.2.178](#)
- [FM Polarity - see page 3.2.184](#)
- [Factory Settings - see page 3.2.185](#)

NOTE: Changing values in the System Settings -> Factory Settings is not normally required, and should only be performed by trained personnel. Information on some of these sub-menus is not included in the manual. Contact Nautel for assistance.

Host Reboot

NOTE: A host reboot is available using the controller UI. Once the host is rebooted, all users that were remotely connected (logged in) will be logged out.

From the controller UI, you can reset the host. To view the Host Reboot screen, select System Settings -> Host Reboot from the Main Menu (see [Figure 3.2.134](#)).

Figure 3.2.134: Host Reboot Screen



Use the up and down buttons to toggle between Force Host Reboot and Cancel. Press the accept (checkmark) button to save the change. If a reset is selected, it will occur immediately. Select Cancel or press X to abort the reset and return to the previous menu.

Host Watchdog

NOTE: Host watchdog configuration is only available using the controller UI.

From the controller UI, you can enable or disable the host watchdog feature. This feature, when enabled, monitors communication between the host (SBC) and the DSP processor on the exciter/control PWB within the controller module. If communication is lost for more than 30 seconds, the transmitter will initiate an alarm and reboot the host. To view the Host Watchdog screen, select System Settings -> Host Watchdog from the Main Menu (see [Figure 3.2.135](#)).

Figure 3.2.135: Host Watchdog Screen

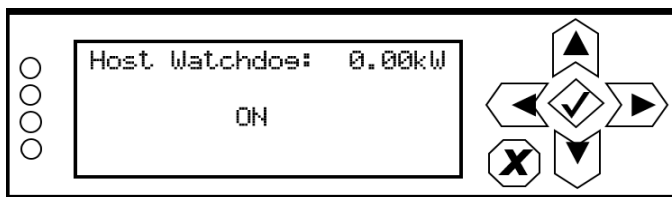

Use the up and down buttons to toggle between ON (enabled) and OFF (disabled). Press the accept (checkmark) button to save the change. Press cancel (X) to discard changes and return to the previous menu.

Firmware Update

NOTE: A firmware update is available using the controller UI. It can also be performed from the AUI, using the Upgrade Software page in the System Settings menu (see [Software Upgrades, on page 3.2.112](#)). Once the host (SBC) is reset, all users that were remotely connected (logged in) will be logged out.

From the controller UI, you can update firmware used in the transmitter. To perform a firmware update, select System Settings -> Firmware Update from the Main Menu (see [Figure 3.2.136](#)).

Figure 3.2.136: Firmware Update Screen



LCD Settings

NOTE: Controller UI display settings are only available using the controller UI.

From the controller's UI, you can configure the LCD display's contrast, brightness and backlight settings. To view the LCD Settings screen, select User Settings -> LCD Settings from the Main Menu (see [Figure 3.2.137](#)).

Figure 3.2.137: LCD Settings Menu

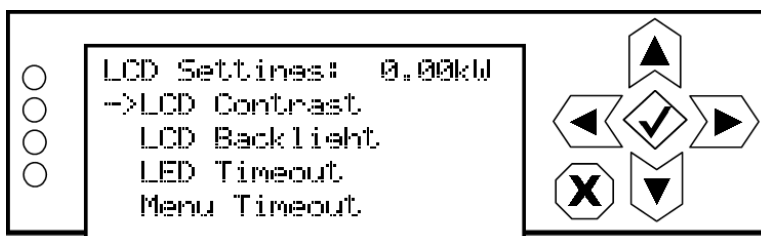

This menu has four sub-menu options:

- ❖ LCD Contrast - sets the display contrast.
- ❖ LCD Backlight - sets the brightness of the display's backlight during normal use.
- ❖ LED Timeout - sets a time delay, after a period of non-use, that the brightness of the display's backlight will dim. This feature can also be disabled.
- ❖ Menu Timeout - sets a time delay, after a period of non-use, that the controller front panel screen will revert back to the main menu.

Use the up and down buttons to move the cursor to the desired display setting and then press the right button to enable editing of the setting. [Figure 3.2.138 on page 3.2.174](#) shows the editing screens for the LCD Settings menu. Within any of the editing screens, use the up and down buttons to edit a setting. Press the accept (checkmark) button to save the change. Press cancel (X) to discard changes and return to the previous menu.

Figure 3.2.138: LCD Settings Editing Screens

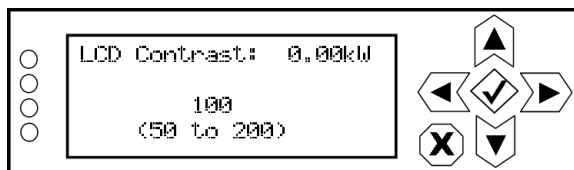

Select a value between 50 (lighter contrast) and 200 (darker contrast) (in increments of 5). Press the cancel (X) button to discard changes and return to the previous menu. Default setting is 100.

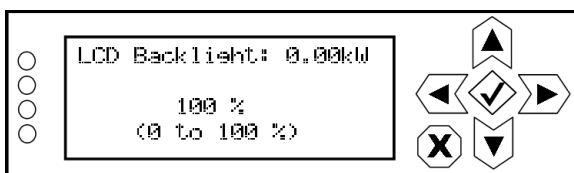

Select a value between 0 and 100% (in 5% increments). Press the cancel (X) button to discard changes and return to the previous menu. Default setting is 100%.

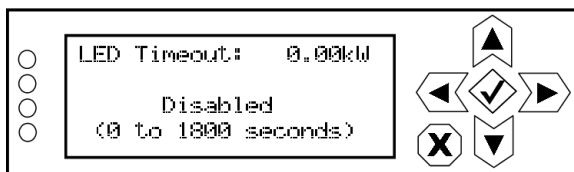

Select disabled (i.e., no timeout) or select a time period between 0 and 1800 seconds (30 minutes) (in 5 s increments). Press the cancel (X) button to discard changes and return to the previous menu. Default setting is 900 s (15 minutes).

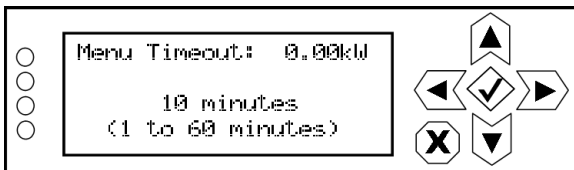

Select a time period between 1 and 60 minutes (in 1 minute increments). Press the cancel (X) button to discard changes and return to the previous menu. Default setting is 10 minutes.

Exciter TCXO

NOTE: You can also adjust the exciter TCXO offset value using the AUI (see [Exciter TCXO](#), on page 3.2.70).

To view the controller UI's Exc TCXO screens (see [Figure 3.2.139](#)), select System Settings -> Calibration from the Main Menu.

Figure 3.2.139: Exc TCXO screens

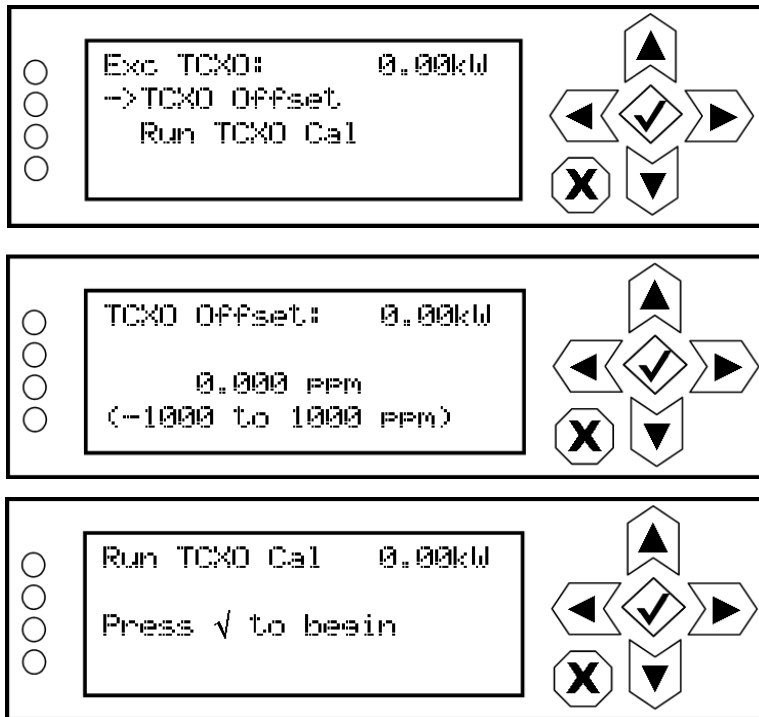

Use the up or down arrow to place the cursor next to TCXO Offset, then press the accept (checkmark) button to enter the TCXO Offset screen. Use the up and down arrows to set the TCXO offset value (in ppm) for the external 10 MHz source. When complete, press the accept (checkmark) button to save the change. Press cancel (X) to discard changes and return to the previous menu.

From the Exc TXCO menu, press the down arrow to place the cursor next to Run TCXO Cal, then press the accept (checkmark) button to enter the Run TCXO Cal screen. The calibration routine will begin when the external 10 MHz source is connected.

HD Optimizer

NOTE: You can also optimize the digital signal (spectrum mask) using the AUI (see [Spectrum Efficiency Optimizer](#), on page 3.2.81).

From the controller's UI, you can enable and configure various HD signal parameters (e.g., injection level, TPO, etc.) in an attempt to optimize the digital signal's overall efficiency. To view the HD Optimizer screen, select User Settings -> HD Optimizer from the Main Menu (see [Figure 3.2.140](#)).

Figure 3.2.140: HD Optimizer Menu

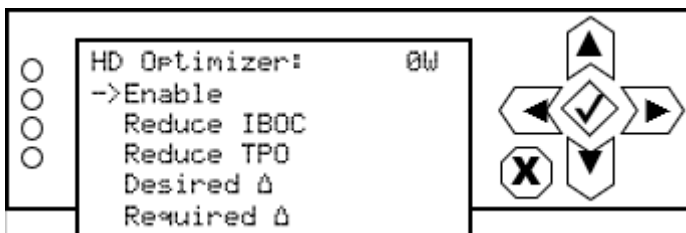

This menu has five sub-menu options:

- ❖ Enable
- ❖ Reduce IBOC
- ❖ Reduce TPO
- ❖ Desired Delta
- ❖ Required Delta

Use the up and down buttons to move the cursor to the desired setting and then press the right button to enable editing of the setting. [Figure 3.2.141](#) on page 3.2.177 shows the editing screens for the HD Optimizer menu. Within any of the editing screens, use the up and down buttons to edit a setting. Press the accept (checkmark) button to save the change. Press cancel (X) to discard changes and return to the previous menu.

Figure 3.2.141: HD Optimizer Screens

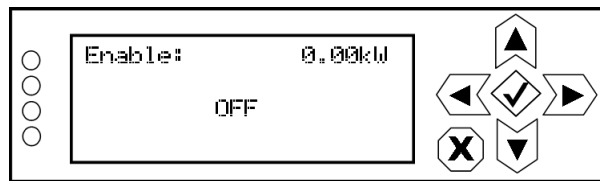

Select ON to allow the optimizer to adjust the PA voltage setting to maximize efficiency based on the transmitter output spectrum. Depending on other settings in this section, it may require other actions to maintain the transmitter's compliance. Select OFF to disable. When disabled, other HD Optimizer settings will have no effect.

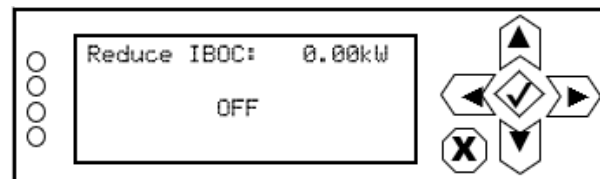

Select ON to enable a reduction in IBOC injection (digital power) if the spectrum mask requires it. Select OFF to disable this setting.

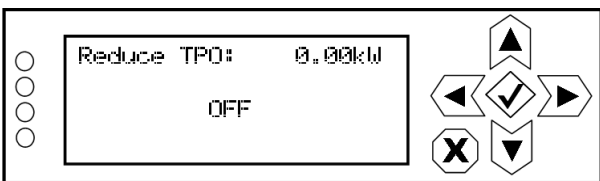

Select ON to enable a reduction in the power set-point if the spectrum mask requires it. Select OFF to disable this setting.

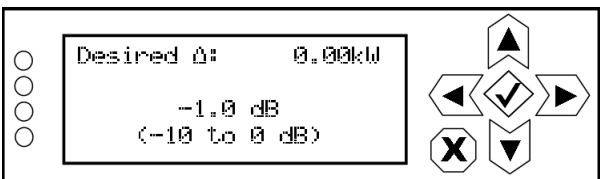

Set the desired clearance (between -10 dB and 0 dB) from the spectral mask. The default setting is -1 dB, which will maintain a 1 dB clearance from the mask for maximum efficiency. This settings will not cause any reduction in output power.

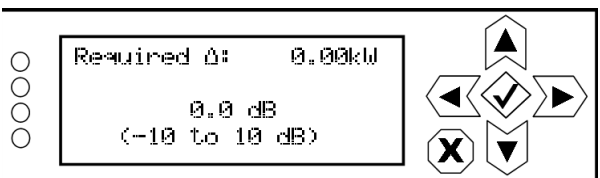

Sets the value (between -10 db and 10 dB) that is considered to be absolutely required. If this level is exceeded, the digital power from the transmitter will be reduced if the PA voltage is at maximum. If the spectral mask still cannot be met and the setting for it is enabled, the transmitter power set-point will be reduced. Default setting is 0.0 dB.

HW Config

From the controller's UI, you can configure the transmitter for any installed hardware that has optional variations (e.g., quantity of exciters or LVPS modules, fan speed) or is non-standard (e.g., UPS or Audio Processor). To view the HW Config screen, select User Settings -> HW Config from the Main Menu (see [Figure 3.2.142](#)).

NOTE: These settings are established at the factory based on the configuration that existed at time of shipping. Changes to these setting are only necessary if hardware is added or removed by the user.

Figure 3.2.142: HW Config Menu

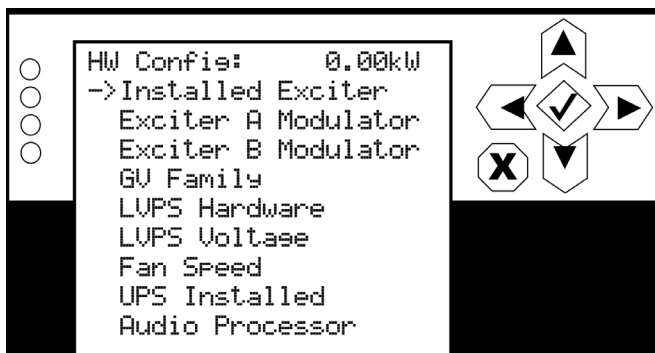

This menu has nine sub-menu options:

- ❖ [Installed Exciter - see page 3.2.179](#)
- ❖ [Exciter A Modulator - see page 3.2.179](#)
- ❖ [Exciter B Modulator - see page 3.2.180](#)
- ❖ [GV Family - see page 3.2.180](#)
- ❖ [LVPS Hardware - see page 3.2.181](#)
- ❖ [LVPS Voltage - see page 3.2.182](#)
- ❖ [Fan Speed - see page 3.2.182](#)
- ❖ [UPS Installed - see page 3.2.183](#)
- ❖ [Orban Audio Processor, on page 3.2.194](#)

NOTE: If running in HD mode, set the GV Family to either GV or GV2 Air Chain prior to enabling the Exciter A/B Modulator configuration.

Installed Exciter

From the controller UI, you can configure the transmitter for the number of installed exciters. If you have upgraded your transmitter to dual exciters, you may have already been prompted to change this configuration. To view the Installed Exc screen, select System Settings -> HW Config -> Installed Exc from the Main Menu (see [Figure 3.2.143](#)).

Figure 3.2.143: Installed Exciter Screen

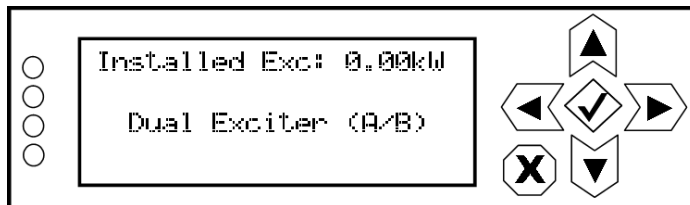

Use the up and down buttons to select the appropriate exciter configuration - Exciter (A) or Dual Exciter (A/B). Press the accept (checkmark) button to save the change. Press X to abort the change and return to the previous menu.

Exciter A Modulator

From the controller UI, you can configure the type of modulator in the exciter. To view the Exciter A options, select System Settings -> HW Config -> Exciter A Modu from the Main Menu (see [Figure 3.2.144](#)).

Figure 3.2.144: Exciter A Modulator

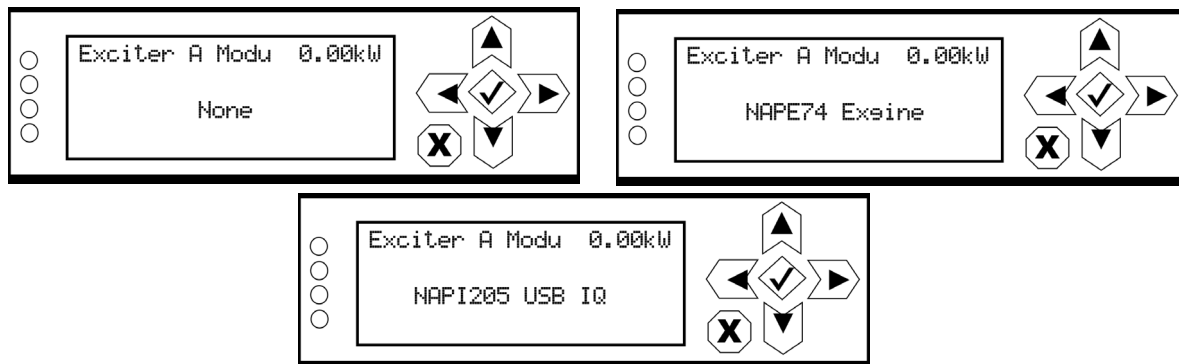

Use the up and down buttons to select the appropriate exciter configuration - None, NAPE74 Exsine or NAPI205 USB IQ. Press the accept (checkmark) button to save the change. Press X to abort the change and return to the previous menu.

NOTE: The NAPI205 USB IQ option is only visible when GV Family is set to GV2 Air Chain.

Exciter B Modulator

Exciter B Modulator is only visible in dual exciter configurations. The options are the same as Exciter A Modulator, see [Exciter A Modulator on page 3.2.179](#) for details.

GV Family

From the controller UI, you can configure the transmitter family type to match with the installed exciters. To view the options for the GV Family screen, select System Settings -> HW Config -> GV Family from the Main Menu (see [Figure 3.2.145](#)).

Figure 3.2.145: GV Family

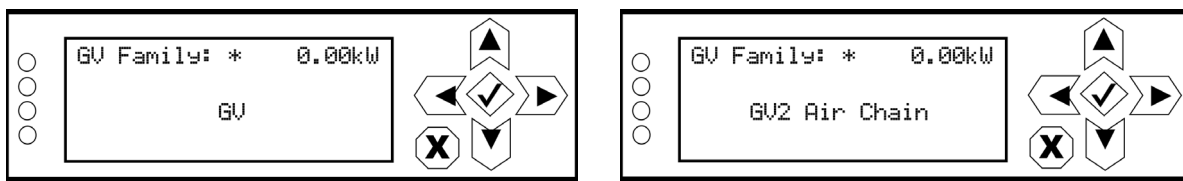

Use the up and down buttons to select the appropriate configuration - GV or GV2 Air Chain. Press the accept (checkmark) button to save the change. Press X to abort the change and return to the previous menu.

Any changes will trigger a warning screen that the Controller will require a reboot. See [Figure 3.2.146](#). Press the accept (checkmark) button to initiate a reboot or press X to exit.

Figure 3.2.146: GV Family Reboot

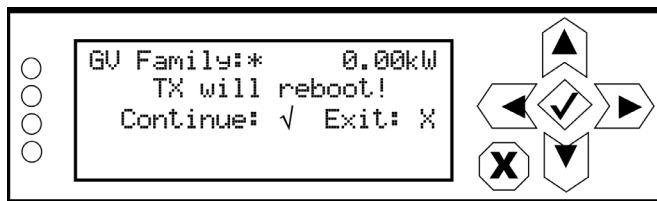

LVPS Hardware

From the controller UI, you can configure the transmitter for the number of installed LVPS modules. If you have upgraded your transmitter to dual LVPS modules, you may have already been prompted to change this configuration. To view the LVPS Hardware screen, select System Settings -> HW Config -> LVPS Hardware from the Main Menu (see [Figure 3.2.147](#)).

Figure 3.2.147: LVPS Hardware Screen

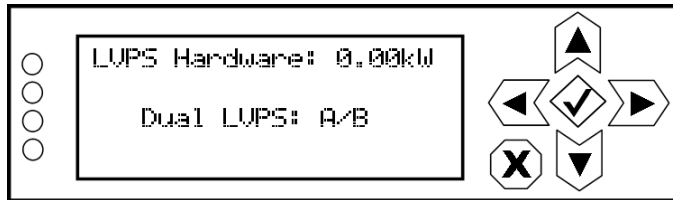

Use the up and down buttons to select the appropriate LVPS configuration - Single LVPS: A or Dual LVPS: A/B. Press the accept (checkmark) button to save the change. Press X to abort the change and return to the previous menu.

LVPS Voltage

From the controller UI, you can set the default LVPS voltage. The transmitter will set the LVPS voltage to this value (between 40 and 53 V, in 1 V steps) during normal operation. Under fault conditions, if the LVPS voltage requires an increase, the control system automatically increases the LVPS voltage, then decreases it back to the set value when the fault condition clears. This setting should not require adjustment.

To view the LVPS Voltage screen, select System Settings -> HW Config -> LVPS Voltage from the Main Menu (see [Figure 3.2.148](#)).

Figure 3.2.148: LVPS Voltage Screen

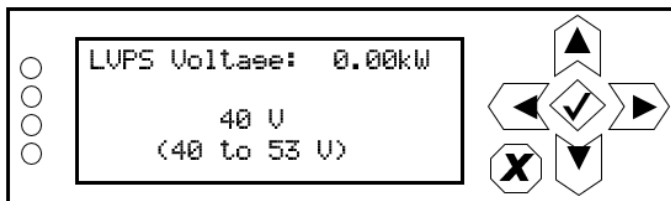

Use the up and down buttons to select a voltage between 40 and 53 V (in 1 V steps). The default setting is 40 V. Press the accept (checkmark) button to save the change. If a reset is selected, it will occur immediately. Press X to abort the change and return to the previous menu.

Fan Speed

The transmitter control function automatically adjusts fan speed to ensure adequate cooling based on all operating conditions. As a result this setting should not require adjustment. Increasing the fan speed will allow for cooler transmitter operation, but will also decrease efficiency and increase acoustic noise levels.

From the controller UI, you can set the default speed of the transmitter's cooling fans. The transmitter will set the fan speed to a percentage (between 63 and 100%) of the maximum speed during normal operation. Under fault conditions, the control system determines if an increase or decrease in fan speed is required and automatically adjusts the fan speed.

To view the Fan Speed screen, select System Settings -> HW Config -> Fan Speed from the Main Menu (see [Figure 3.2.149](#)).

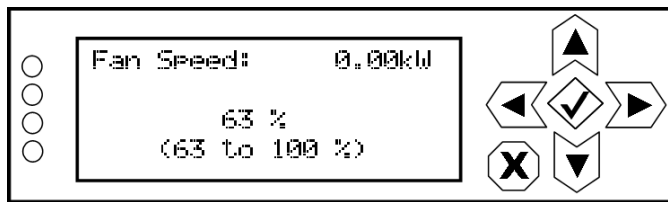
Figure 3.2.149: Fan Speed Screen

Use the up and down buttons to select a value between 63 and 100%. The default setting is 63%, which corresponds to approximately 31 V for the related fan voltage. A setting of 100% corresponds to approximately 48 V for the related fan voltage. Press the accept (checkmark) button to save the change. Press X to abort the change and return to the previous menu.

NOTE: A 20% reduction in fan speed can yield up to 5 dB improvement in acoustic noise from the transmitter, as well as decrease power consumption (i.e., utility costs) and extend the operating life of the cooling fans.

UPS Installed

From the controller UI, you can configure the transmitter for the installation of the UPS interface kit, which allows operation with an external, user-provided UPS. If you have upgraded your transmitter with the UPS interface, you may have already been prompted to change this configuration. To view the UPS Installed screen, select System Settings -> HW Config -> UPS Installed from the Main Menu (see [Figure 3.2.150](#)).

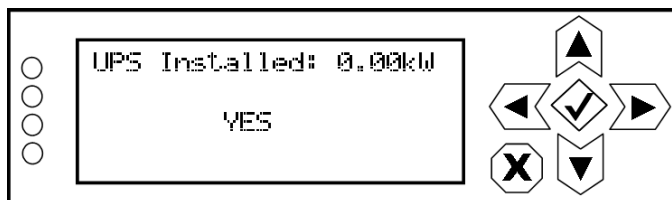
Figure 3.2.150: UPS Installed Screen

Use the up and down buttons to toggle between NO (no UPS interface installed) and YES (UPS interface is installed). Press the accept (checkmark) button to save the change. Press X to abort the change and return to the previous menu.

FM Polarity

NOTE: Adjusting FM polarity is used to synchronize transmitters for a single-frequency network. It determines whether positive audio input results in positive or negative modulation.

From the controller front panel UI, you can set the FM polarity. To view the FM Polarity screen, select System Settings -> FM Polarity from the Main Menu (see [Figure 3.2.151](#)).

Figure 3.2.151: FM Polarity Screen

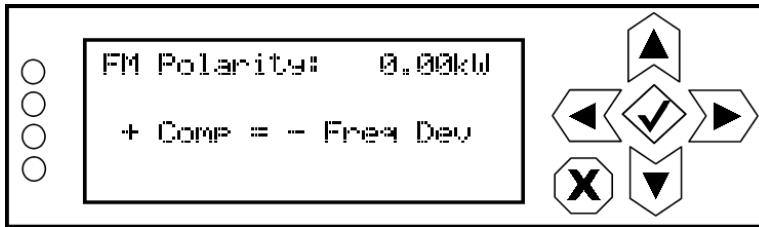

Use the up and down buttons to toggle between + Comp = - Freq Dev and + Comp = + Freq Dev. The default setting is + Comp = - Freq Dev . Press the accept (checkmark) button to save the change. Press X to abort the change and return to the previous menu.

Factory Settings

NOTE: Factory Settings are only available using the controller UI.

CAUTION! Changing values in the System Settings -> Factory Settings menu is not normally required, and should only be performed by trained personnel. Information on some of these sub-menus is not included in the manual. Contact Nautel for assistance.

From the controller's UI, you can adjust various factory settings such as critical parameter thresholds, calibration values, exciter PA power level, etc. To view the Factory Settings menu (see [Figure 3.2.152](#)), select System Settings-> Factory Settings from the Main Menu.

Figure 3.2.152: Factory Settings Menu

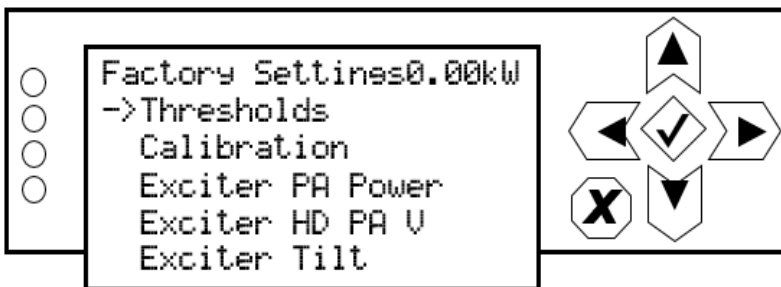

This menu has five sub-menu options:

- ❖ [Thresholds](#) - see page 3.2.186
- ❖ [Calibration](#) - see page 3.2.187 (see **IMPORTANT** note below)
- ❖ [Exciter Tilt](#) - see page 3.2.188
- ❖ [Exciter PA Power](#) - see page 3.2.189
- ❖ [Exc HD PA V](#) - see page 3.2.189

IMPORTANT! The Calibration menu (see [Calibration, on page 3.2.187](#)) contains a Xmtr PA Bias routine that must be initiated after any of the following events:

- ❖ A new RF power module has been installed in the transmitter
- ❖ RF power modules have swapped positions
- ❖ A new controller module has been installed in the transmitter

Thresholds

NOTE: Threshold settings are only available using the controller UI.

WARNING! Threshold settings are established at the factory and should not require any adjustment. These settings affect critical system protection circuits. Making changes to these settings may void your warranty. Contact Nautel before making changes.

From the controller's UI, you can set alarm thresholds for critical parameters. To view the Thresholds menu (see [Figure 3.2.153](#)), select System Settings -> Factory Settings -> Thresholds from the Main Menu.

Figure 3.2.153: Thresholds Menu

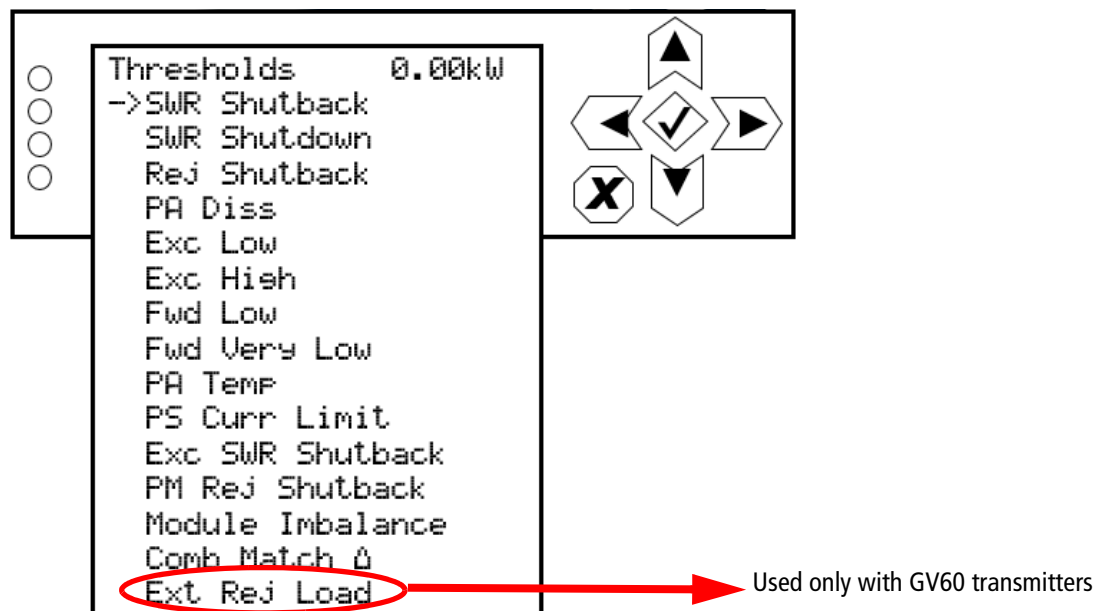

Calibration

NOTE: Most of the Calibration settings are only available using the controller UI.

From the controller's UI, you can calibrate various parameters. To view the Calibration menu (see [Figure 3.2.154](#)), select System Settings -> Factory Settings -> Calibration from the Main Menu.

Figure 3.2.154: Calibration Menu

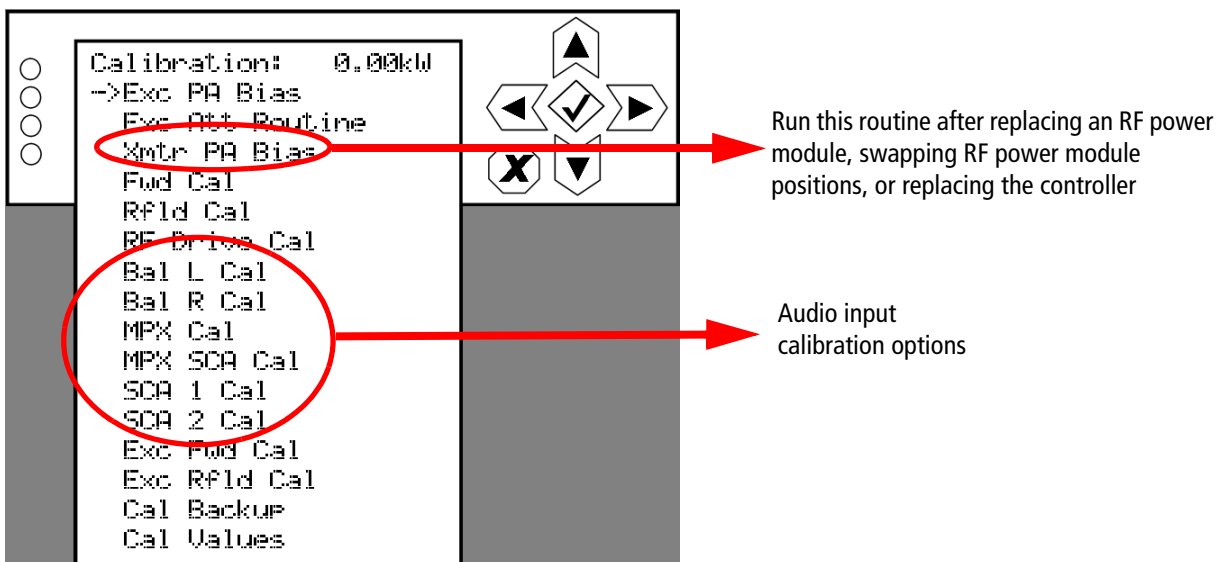

Running the Xmtr PA Bias Routine

You must run the transmitter's PA bias routine immediately after one of the following events:

- ❖ installation of a new RF power module
- ❖ swapping of existing RF power modules
- ❖ installation of a new controller module

NOTE: Make sure that the RF stage is disabled (RF Off) and the interlock circuit is closed before running the PA bias routine. If not, a message will appear on the display prompting you to do so.

Use the up or down arrow to place the cursor next to Xmtr PA Bias, then press the accept (checkmark) button to enter the sub-menu. Within the sub-menu, press the accept (checkmark) button to start the routine. A line will display to indicate the percentage of completion. When it is complete, the display will again read "Press ✓ to begin". Press X to return to the previous menu.

Calibrating Audio Inputs

Use the up or down arrow to place the cursor next to the desired audio input calibration item (Bal L Cal, Bal R Cal, MPX Cal, MPX SCA Cal, SCA 1 Cal or SCA 2 Cal), then press the accept (checkmark) button to enter the selected audio input. With the appropriate calibrated audio source(s) applied, use the up and down arrows to set the new calibration value for the selected audio input. When complete, press the accept (checkmark) button to save the change. Press cancel (X) to discard changes and return to the previous menu.

NOTE: Forward power (Fwd Cal), reflected power (Refld Cal), RF Drive, exciter forward (Exc Fwd) and exciter reflected (Exc Rfld) calibrations are performed at the factory and should not require user adjustment. Contact Nautel for assistance, if necessary.

Exciter Tilt

From the controller front panel UI, you can set the exciter tilt settings. To view the Exciter Tilt screen, select System Settings -> Factory Settings -> Exciter Tilt from the Main Menu (see [Figure 3.2.155](#)).

NOTE: Exciter tilt settings are only available using the controller front panel UI.

WARNING! Exciter tilt settings are established at the factory and should not require any adjustment. Making changes to these settings may void your warranty. Contact Nautel before making changes.

Figure 3.2.155: Exciter Tilt Screen



Use the up or down arrow to place the cursor next to Tilt Opt or Tilt Adjust, then press the accept (checkmark) button to enter the sub-menu. Within the sub-menus, select the desired option or setting and press the accept (checkmark) button to save the setting. Press X to return to the previous menu.

Exciter PA Power

NOTE: The exciter PA power setting is only available using the controller UI.

From the controller UI, you can set the exciter's PA power level at 98 MHz. To view the Exciter PA Power screen, select System Settings -> Factory Settings -> Exciter PA Power from the Main Menu (see [Figure 3.2.156](#)). The transmitter automatically compensates the actual exciter PA power level based on the operating frequency so there should be no need to adjust this value.

Figure 3.2.156: Exciter PA Power Screen

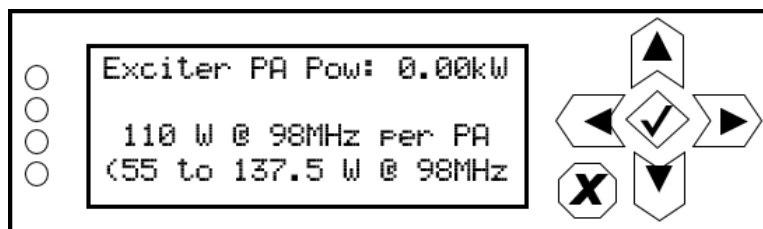

Use the up and down buttons to select a power level between 55 and 137.5 W (in 5 W increments). Press the accept (checkmark) button to save the change. Press X to abort the change and return to the previous menu.

Exc HD PA V

NOTE: The exciter PA power setting is only available using the controller UI.

From the controller UI, you can set the exciter's HD PA voltage. To view the Exc HD PA V screen, select System Settings -> Factory Settings -> Exc HD PA V from the Main Menu (see [Figure 3.2.157](#)).

Figure 3.2.157: Exc HD PA V Screen

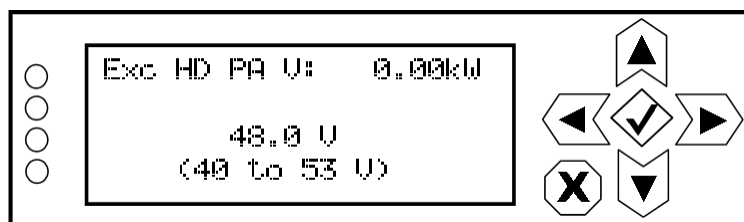

Use the up and down buttons to select a voltage between 40 and 53 V (in 0.5 V increments). Default setting is 48.0 V. Press the accept (checkmark) button to save the change. Press X to abort the change and return to the previous menu.

Remote I/O Settings

To view the Remote I/O screen (see [Figure 3.2.158](#)) on the controller UI, select Remote I/O from the Main Menu.

Figure 3.2.158: Remote I/O screen

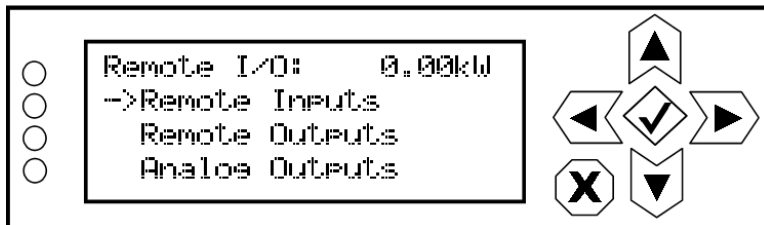

Use the up and down buttons to select Remote Inputs (see [Remote Inputs](#)), Remote Outputs (see [Remote Outputs](#), on page 3.2.192) or Analog Outputs (see [Analog Outputs](#), on page 3.2.193) to view or edit detail on the selected inputs or outputs.

Remote Inputs

Using the Remote Inputs screens (see [Figure 3.2.159](#) on page 3.2.191), you can configure up to 10 remote inputs that allow you to remotely control various operational characteristics of the transmitter. Unless otherwise noted, these inputs are only accepted by the transmitter if remote control is enabled. That setting can only be made by a local user using the front panel AUI.

Nautel sets remote input defaults prior to shipping. See the GV2-10/GV2-7.5 Pre-installation Manual for details.

Figure 3.2.159: Remote Inputs Screens (Input 1 shown)

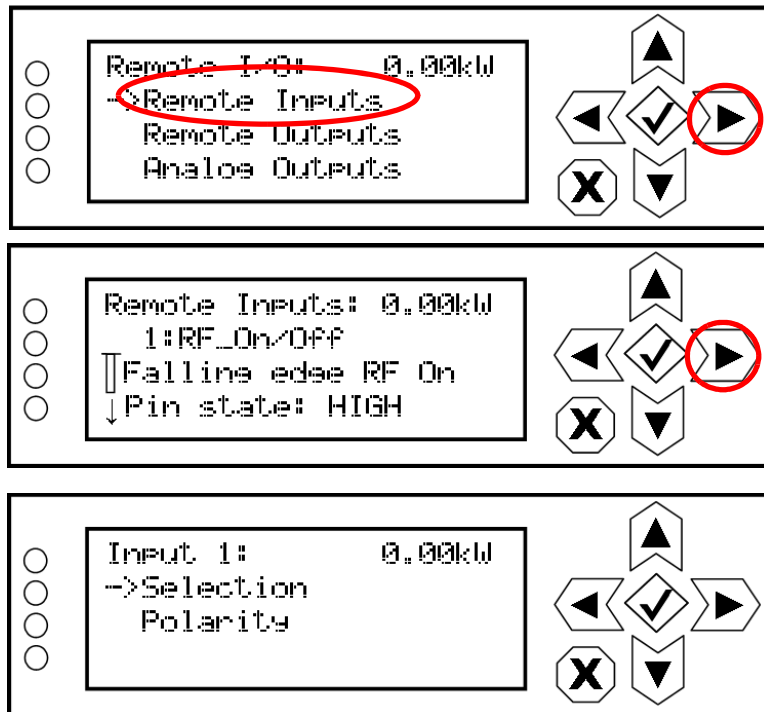

Use the up and down buttons to select the desired remote input (1 through 10) from the list. Each screen shows the current remote input parameter (e.g., RF On/Off), as well as the polarity (e.g., Falling edge RF On) and current state (e.g., high, low) of the corresponding input pin. Use the right-arrow button to enter the Selection/Polarity screen for the selected input to allow editing of the selection or the polarity. Press cancel (X) to return to the previous menu.

If you save a change to a remote input via the controller UI, it will also be displayed on the AUI page.

NOTE: The selection and polarity options for remote inputs are the same as described in [Select Input Channel, on page 3.2.103](#) and [Configure Input Control Logic, on page 3.2.104](#).

Remote Outputs

Using the Remote Outputs screens (see [Figure 3.2.160](#)), you can configure up to 16 remote outputs that indicate either the presence of various alarms or the status of operator controlled circuits.

Nautel sets remote output defaults prior to shipping. See the GV2-10/GV2-7.5 Pre-installation Manual for details.

Figure 3.2.160: Remote Outputs Screens (Output 1 shown)

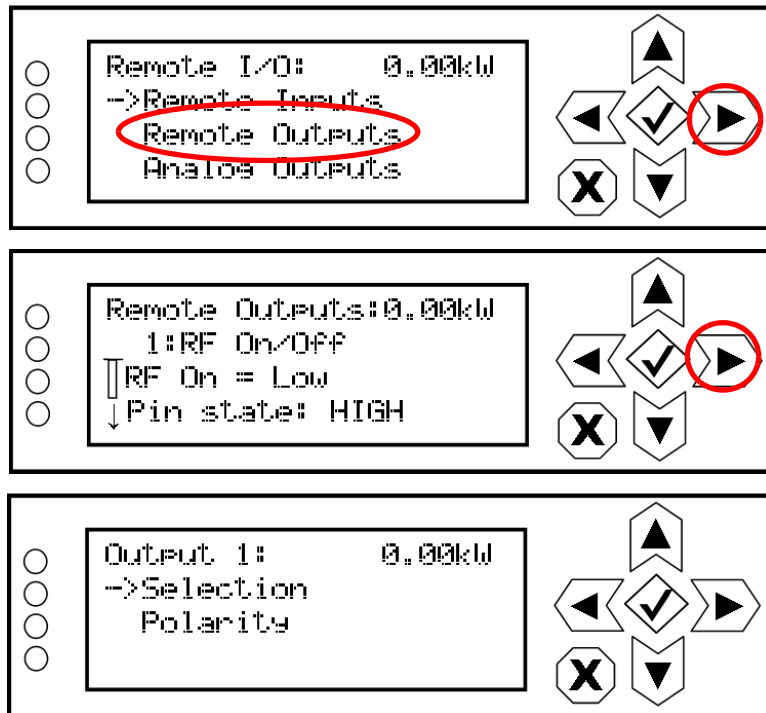

Use the up and down buttons to select the desired remote output (1 through 16) from the list. Each screen shows the current remote output parameter (e.g., RF On/Off), as well as the polarity (e.g., RF On = Low) and current state (e.g., high, low) of the corresponding output pin. Use the right-arrow button to enter the Selection/Polarity screen for the selected output to allow editing of the selection or the polarity. Press cancel (X) to return to the previous menu.

If you save a change to a remote output via the controller UI, it will also be displayed on the AUI page.

NOTE: The selection and polarity options for remote outputs are the same as described in [Select Output Channel](#), on page 3.2.106 and [Configure Output Logic](#), on page 3.2.106.

Analog Outputs

Using the Analog Outputs screens (see [Figure 3.2.161](#)), you can view the levels of four pre-defined analog outputs that are representative of critical transmitter parameters.

Nautel sets analog output defaults prior to shipping. There are no configuration options. They are for monitoring purposes only. See the GV2-10/GV2-7.5 Pre-installation Manual for details.

Figure 3.2.161: Analog Outputs Screens

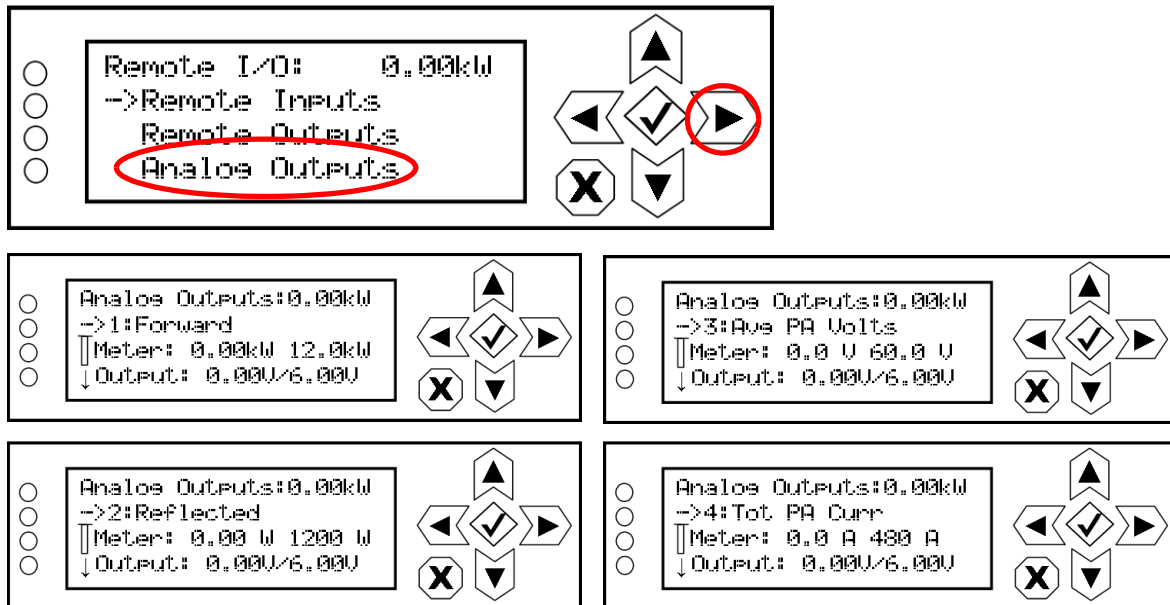

Use the up and down buttons to select the desired analog output (1 through 4) from the list. Each screen shows the analog output parameter (e.g., Forward Power, Reflected Power, Avg PA Volts or Total PA Current), as well as the meter reading (actual and full-scale) and the output pin voltage (actual and full-scale). Press cancel (X) to return to the previous menu.

NOTE: The analog output's Output voltage reading reflects the value that can be measured at the associated remote analog output pin for the given Meter value. See the Pre-installation Manual for actual remote analog output pin assignments.

Orban Audio Processor

This section describes how to configure, enable and operate the optional Orban audio processor after it is installed in your transmitter. You can interface with audio processor functionality using the transmitter's local (or remote) AUI or controller UI. The extent of the features available depends on which interface is used.

- [Configuring the Transmitter for the Orban Audio Processor - see page 3.2.195](#)
- [Enabling the Orban Audio Processor for Preset Selection - see page 3.2.196](#)
- [Selecting an Orban Audio Processor Preset - see page 3.2.198](#)

NOTE: Using the Orban Inside option requires the installation of an Orban audio processor card in your transmitter. If you had a pre-existing transmitter when you received your Orban Inside kit, verify that the Orban card has been installed in the transmitter according to the Orban Inside Quick Guide (QG12001), provided with the Orban Inside kit. Refer to the Pre-installation and Installation Manuals for information on purchasing and installing this option.

NOTE: This section contains frequent reference to Orban's Optimod-FM 5500 Digital Audio Processor Operating Manual (see the link below). The equipment covered in the 5500 manual uses the same Orban audio processor as in your transmitter. The 5500 manual provides detailed information on the audio processor's functionality. If a discrepancy exists between the operational instructions in the Orban manual and this document, the latter shall prevail as this document is specific to operation with an GV2-10/GV2-7.5 transmitter. View the Orban Optimod-FM 5500 Digital Audio Processor Operating Manual online at:

http://www.orban-europe.com/downloads/5500/Documentation/5500_1.2_Operating_Manual.pdf

(the version number referenced in this link is controlled by a third party and is subject to change without notice)

Configuring the Transmitter for the Orban Audio Processor

Configure the GV2-10/GV2-7.5 to recognize the presence of the Orban card using the controller UI (see [Orban Enabling](#)) or the AUI (see [Orban Enabling - Using the Remote AUI - see page 3.2.67](#)) as follows:

NOTE: Configuring the Orban audio processor locally will cause the AUI to display an Orban Inside setting. The same occurs on the controller UI when configuring via the AUI.

Orban Hardware Configuration

1. With the transmitter turned on and in local mode of operation, navigate to the controller UI's Main Menu -> System Settings -> HW Config menu. Scroll down through this menu and select Audio Processor (see [Figure 3.2.162](#)).
2. In the Audio Processor screen (see [Figure 3.2.162](#)), use the up and down buttons to toggle between None and Orban Inside (default factory setting is None). Select Orban Inside to enable the Orban audio processor for use (selecting None disables it). Press the accept (checkmark) button to save the change. Press cancel (X) to discard changes and return to the previous menu.
3. Reboot the transmitter by switching the ac power off and then on. This will ensure the transmitter properly detects the Orban Inside card upon recovery.

Figure 3.2.162: Configuring the Transmitter - Controller UI HW Config and Audio Processor screens

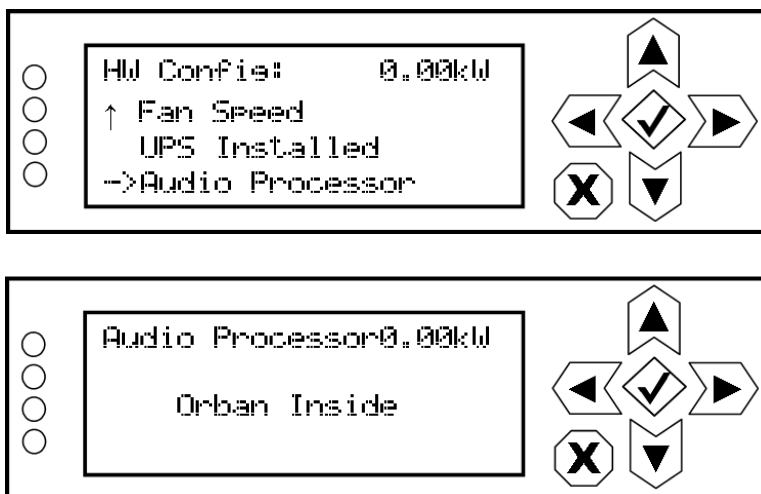

Enabling the Orban Audio Processor for Preset Selection

Enable the Orban audio processor to allow preset selection using either the controller UI (see [Orban Enabling](#)) or the AUI (see [Orban Enabling - Using the Remote AUI - see page 3.2.67](#)) as follows:

NOTE: Enabling the Orban audio processor locally will cause the AUI to display an enabled setting. The same occurs on the controller UI when enabling via the AUI.

Orban Enabling

1. With the transmitter turned on and in local mode of operation, navigate to the controller UI's Main Menu -> User Settings menu. Select Edit Presets (see A in [Figure 3.2.163 on page 3.2.197](#)).
2. In the Edit Presets screen (see B in [Figure 3.2.163 on page 3.2.197](#)), select from the list the desired preset for use with the Orban audio processor or create a new preset.
3. Within the selected preset's screen (see C in [Figure 3.2.163 on page 3.2.197](#)), scroll down and select Main Audio.
4. Within the Main Audio screen (see D in [Figure 3.2.163 on page 3.2.197](#)), scroll down and select Audio Processor. This option appears only when the transmitter has been configured for Orban Inside.
5. Within the Audio Processor screen (see E in [Figure 3.2.163 on page 3.2.197](#)), select Enable. From the Enable screen, select ON to enable the audio processor (selecting OFF disables the audio processor)

NOTE: The Orban Inside card processes only the main audio; however it is possible for the composite SCA inputs to result in excessive modulation. The L/R limiter is automatically disabled when the Orban Inside card is selected; however the other limiters (hard limiter, AGC limiter, 2-slope limiter) remain active. Nautel recommends that you set the thresholds for these other limiters high enough to ensure the signal is unaffected. These other limiters remain as a last resort to prevent over-modulation.

Figure 3.2.163: Enabling the Orban Audio Processor - Controller UI

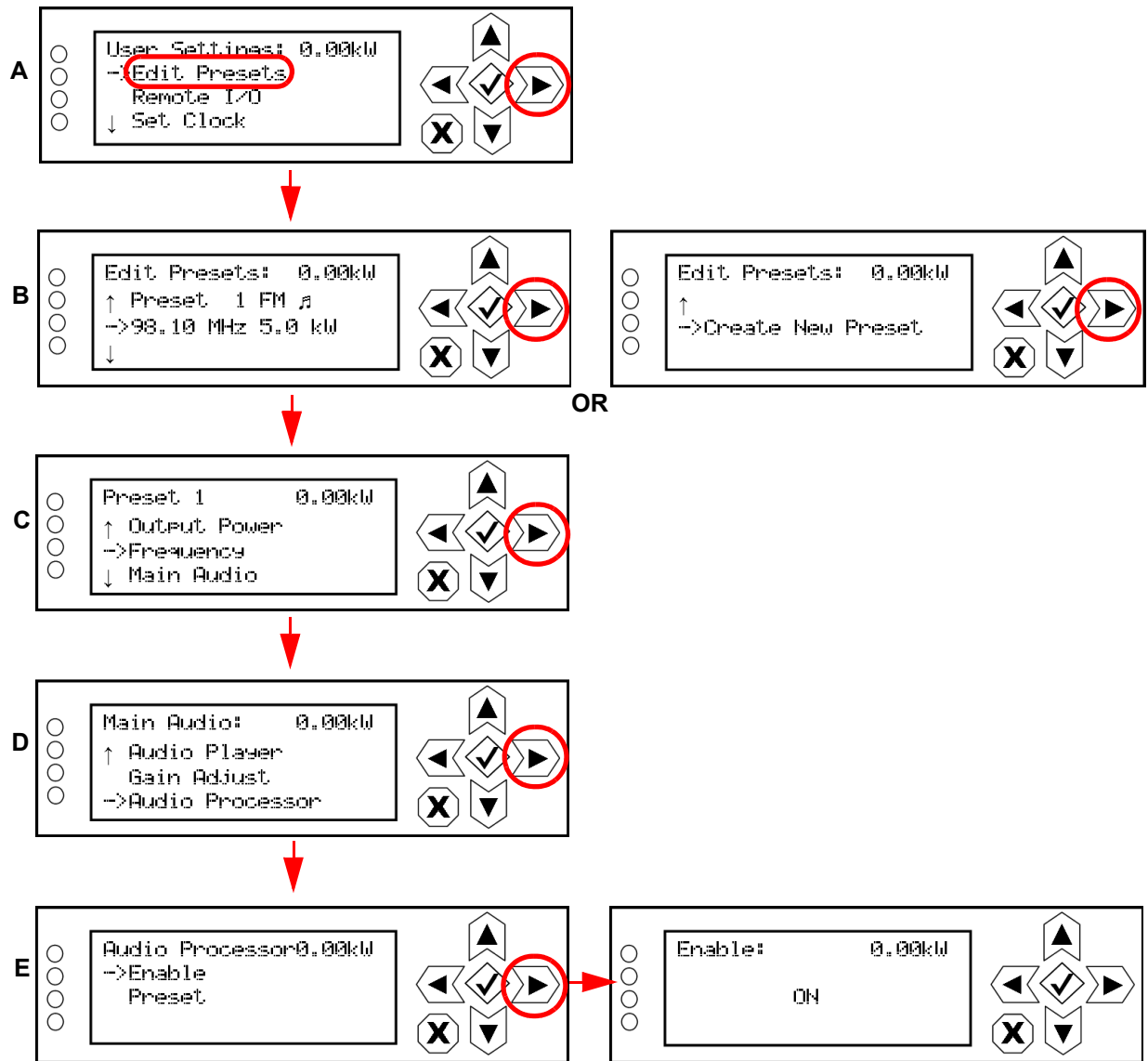

Selecting an Orban Audio Processor Preset

Select an Orban audio processor preset using either the AUI (see [Orban Enabling - Using the Remote AUI](#) - see page 3.2.67) or the controller UI (see [Selecting an Orban Preset](#)) as follows:

NOTE: Selecting an Orban preset via the AUI will cause the controller UI to also reflect the change, and vice versa.

Selecting an Orban Preset

1. From the User Settings -> Edit Presets -> (Select desired preset to edit) -> Main Audio -> Audio Processor menu (see [Figure 3.2.164](#)), select Preset.
2. Use the up and down arrows to scroll through the list of available Orban presets (e.g., ROCK-LOUD, etc). Select the desired preset and press the 'accept' (checkmark) button to activate. Refer to the Orban Optimod 5500 manual for detailed information on the factory programmed presets available.

Figure 3.2.164: Selecting an Orban Preset - Front Panel UI

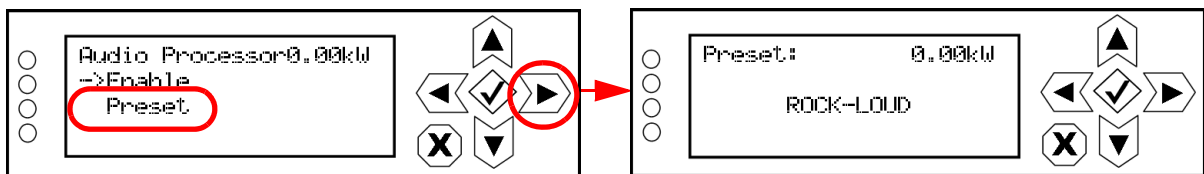

SECTION 3.3: ROUTINE MAINTENANCE

This section provides instructions for performing routine maintenance on the GV2-10/GV2-7.5 transmitter. This section includes the following topics:

- [Scheduled Maintenance](#)
 - ❖ [Cleaning](#)
 - ❖ [Checking Hardware - see page 3.3.2](#)
 - ❖ [Battery Replacement - see page 3.3.2](#)
- [Replacing an Air Filter - see page 3.3.3](#)
- [Performing On-Air Checks - see page 3.3.6](#)
- [Replacing the Controller Module's Battery - see page 3.3.7](#)
- [Inspecting Lightning Protection Systems - see page 3.3.9](#)

Scheduled Maintenance

Scheduled maintenance consists of performing a visual inspection of the GV2-10/GV2-7.5 at scheduled intervals. The recommended minimum time between scheduled maintenance visits is three months. Local operating and environmental conditions may dictate more frequent visits, while in remote sites less frequent visits may be acceptable. Experience and system reliability will determine the most practical schedule for a specific installation.

Cleaning

At a minimum, follow the cleaning procedures listed below.

NOTE: A site located in a dirty area using open-air cooling requires more extensive cleaning than a site located in a clean area using closed-air cooling.

1. Check the air filters, noting there is one in the front door of the transmitter and one in the back of the transmitter. Remove each air filter, inspect it, then re-install the air filter if it is clean. If an air filter is dirty or damaged, replace it as soon as possible. See [Replacing an Air Filter, on page 3.3.3](#).
2. Clean the GV2-10/GV2-7.5 using a vacuum cleaner and a soft-bristle brush to remove loose dirt. Clean, damp rags should be used to remove dirt that cannot be removed with a vacuum cleaner. Never use compressed air to clean the GV2-10/GV2-7.5.

Checking Hardware

All hardware must be checked at least once a year. Thermal cycling from turning the GV2-10/GV2-7.5 on and off will require more frequent checks.

- To prevent damaging the hardware, ensure that the proper sized tools are used. In most cases, hardware is metric.
- A mounting surface or terminal that has changed colour indicates a loose hardware connection.
- Check and, if necessary, retorque the ac input cables on terminal block TB1. See [“Connecting Ac Power” on page 2.5.1.](#) of the GV2-10/GV2-7.5 Installation Manual to determine specific torque values.

Battery Replacement

The controller assembly contains a battery backup circuit that provides a memory of the transmitter time setting during ac power failure. See [Replacing the Controller Module’s Battery, on page 3.3.7.](#)

Replacing an Air Filter

The transmitter contains one cotton air filter in the front door of the transmitter (see [Figure 3.3.1 on page 3.3.4](#)) and one in the upper, rear panel of the transmitter (see [Figure 3.3.2 on page 3.3.5](#)). If an air filter becomes dirty or damaged, replace it as follows:

Interval

As required.

Parts and tools

- Replacement air filter

Procedure

Take the following steps to replace an GV2-10/GV2-7.5 air filter:

1. Order a new filter or filters, as necessary. You can order a standard sized filter from Nautel (Nautel Part # HR196) or from the manufacturer (standard size 18" x 24" x 2" American Air Filter PerfectPleat SC M8 MERV 8 or equivalent; actual size 17.5" x 23.5" x 1.75") or obtain one from any local supplier of HVAC supplies.
2. Unpack the new filter and inspect it for damage.
3. Remove the old or damaged filter as follows:
 - ❖ For a front air filter (see [Figure 3.3.1 on page 3.3.4](#)), open the front door. On the back side of the door, loosen the two quarter-turn fasteners securing the filter bracket to the door. Lift out the filter bracket. Remove (slide out) the air filter from the door.
 - ❖ For a rear panel filter (see [Figure 3.3.2 on page 3.3.5](#)), loosen only the four quarter-turn fasteners securing the filter bracket to the panel (removal of the entire rear panel is not necessary). Remove the filter bracket. Remove (slide out) the air filter from the panel.
4. Insert the new air filter into the bracket, noting the air flow direction in [Figure 3.3.1 on page 3.3.4](#) or [Figure 3.3.2 on page 3.3.5](#). Reinstall the filter bracket on the front door or rear panel, as applicable. Tighten the quarter-turn fasteners to secure the filter bracket to the front door (two fasteners) or rear panel (four fasteners).
5. Dispose of the dirty or damaged air filter.

Figure 3.3.1: Replacing Front Air Filters

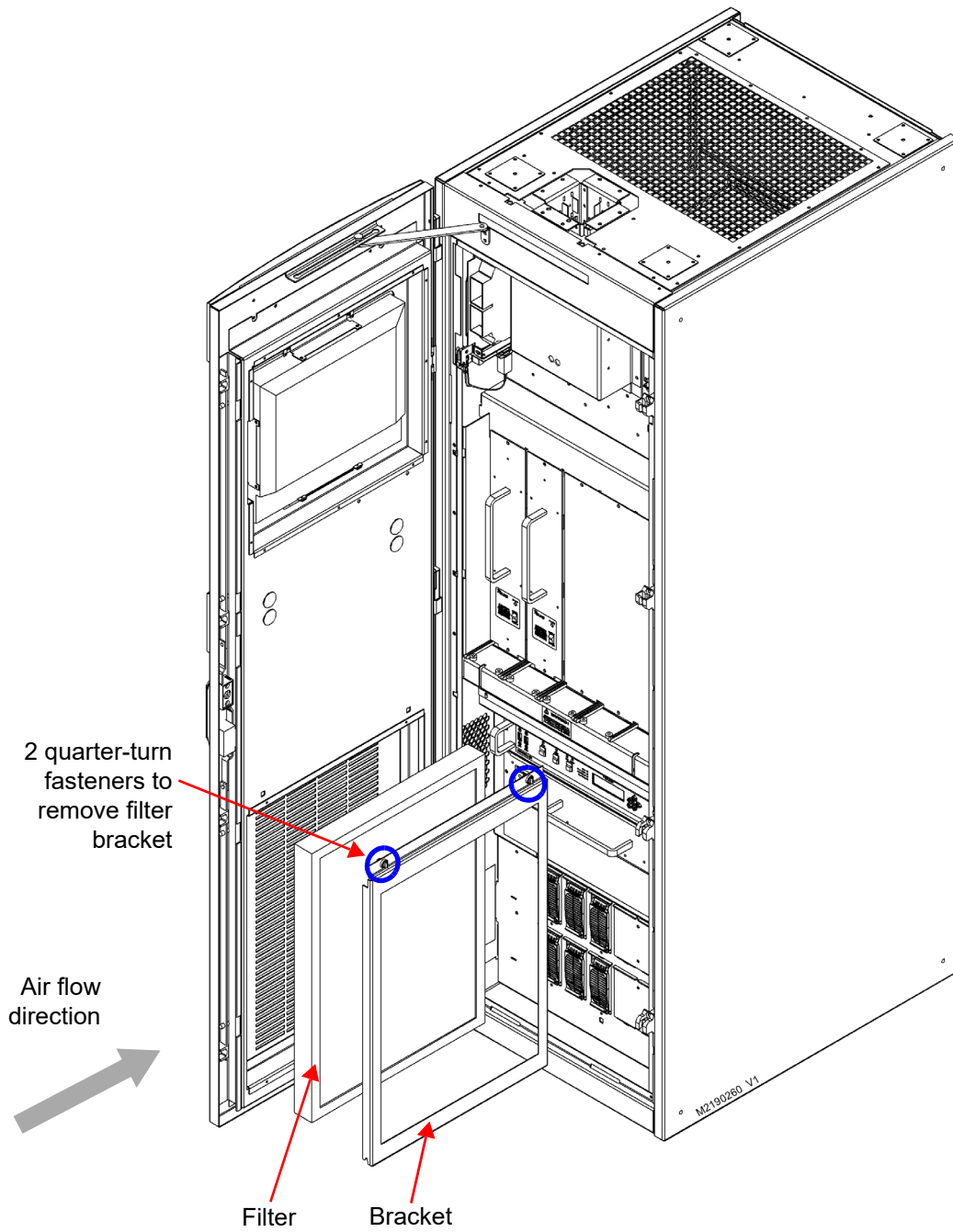
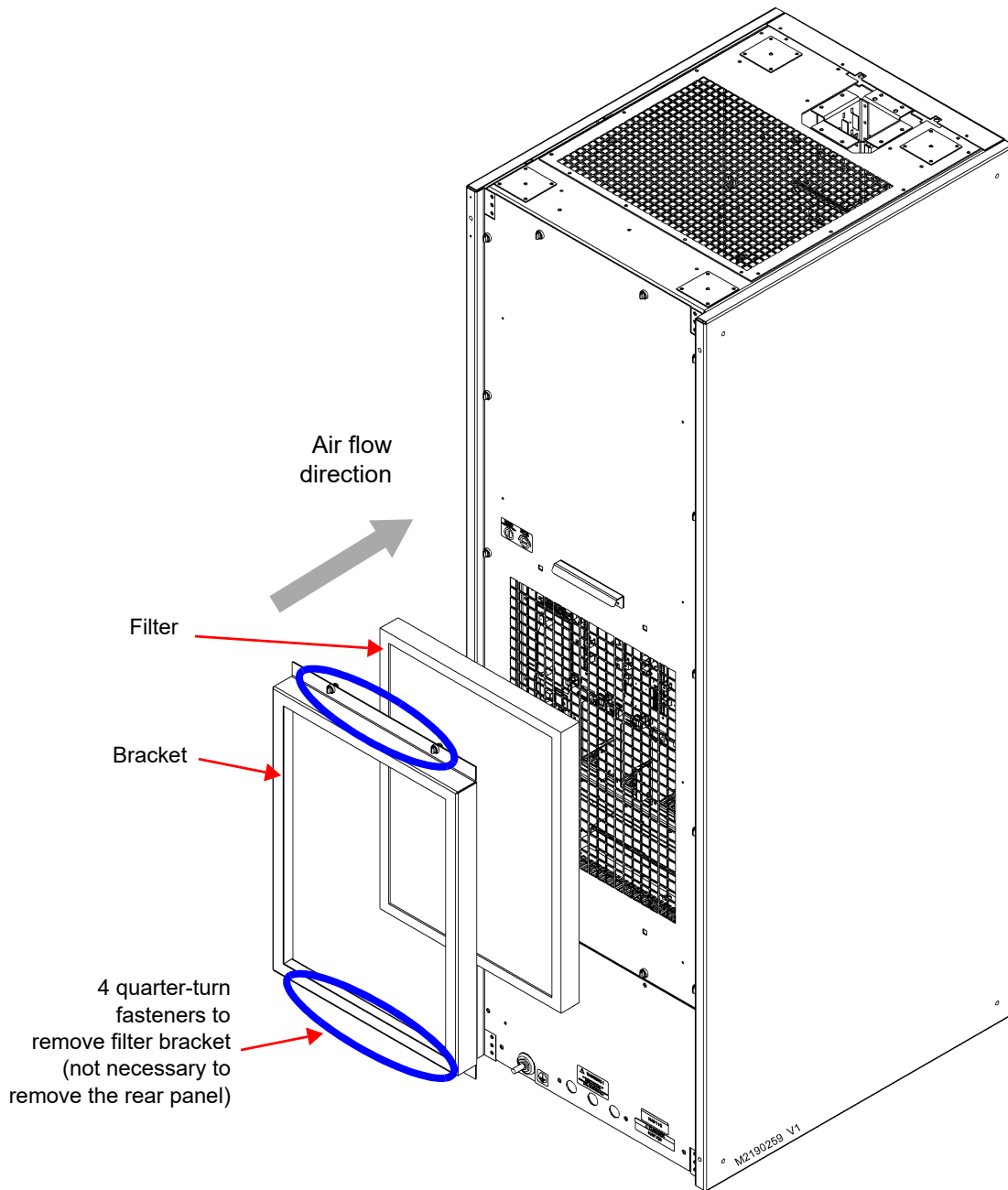

Figure 3.3.2: Replacing Rear Air Filters



Performing On-Air Checks

You should check the on-air quality of the transmitter's signal periodically. This check can be done locally at the transmitter site, or remotely from another location in the transmitter's coverage area.

Interval

Every 12 months, or as required by law.

Parts and Tools

- High-quality receiver compatible with the modulation scheme used on the transmitter.

Procedure

1. Monitor the transmitter signal to identify any problems:
 - ❖ Use a high quality receiver to monitor audio quality.
 - ❖ Check the spectral output of the transmitter. You can use the local or remote AUI's spectrum analyzer to accurately assess the transmitter's spectral output.
 - ❖ Take a portable receiver to different locations in your coverage areas to identify any problems with the antenna pattern or areas of localized interference.
2. Obtain the Critical Parameters sheet that was completed during factory testing and provided with the transmitter. Use the transmitter's AUI to compare current transmitter settings with those on the Critical Parameters sheet.

NOTE: Nautel completes the Critical Parameters sheet with the transmitter terminated into a precision 50 ohm load. Measurements made on site into a dummy load or station antenna may not yield the same readings. Slight variances are acceptable. The data is provided as a troubleshooting aid.

Replacing the Controller Module's Battery

Replace the battery on the controller module's controller PWB (A4A2) once a year, or whenever the Controller - Low Battery alarm appears (on the AUI, controller UI or via remote digital output). Chemical leakage from an old battery can cause damage.

Interval

Every 12 months.

Parts and Tools

Replacement battery: 3 V lithium coin cell, 20 mm (Panasonic # CR2032 or equivalent).

Procedure

Perform the following steps to replace the battery:

1. Remove the upper, rear filter panel by loosening the 12 quarter-turn fasteners securing the panel to the transmitter.
2. Replace the battery in the 3V BATTERY holder on the rear of the controller assembly (see [Figure 3.3.3 on page 3.3.8](#)).
3. Re-install the upper, rear filter panel removed in [Step 1](#).
4. Check for any alarms on the AUI (local or remote) or controller UI (see [View Status, on page 3.2.164](#)). Battery related alarms should clear.
5. Reset the system clock via the AUI (local or remote) or controller UI (see [Setting the Clock, on page 3.2.151](#)).

NOTE: If the NTP server feature has been enabled, your clock setting will automatically reset within approximately five minutes. See [NTP servers, on page 3.2.96](#) for more information.

Figure 3.3.3: Replacing Controller Battery

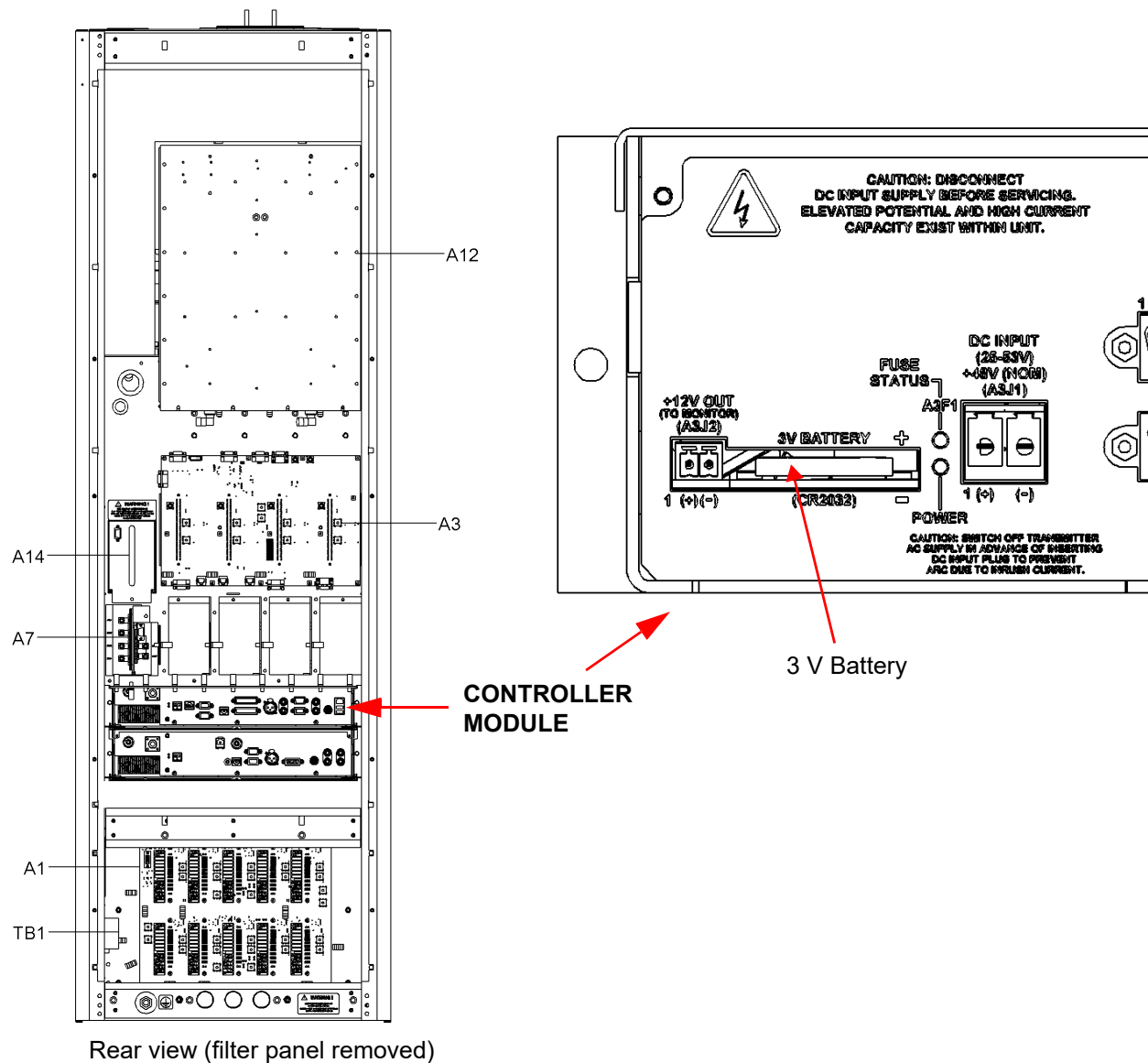

Inspecting Lightning Protection Systems

You should inspect the lightning protection systems that are connected to your GV2-10/GV2-7.5 transmitter, ac power, RF feedline, antenna and tower periodically to ensure that your site, equipment and personnel are fully protected.

Interval

Every 6 months.

Parts and Tools

Depends on your site, but may include a digital multimeter, ladder, binoculars, and continuity tester.

Procedure

Perform the following steps to test the lightning protection systems:

1. Test the continuity between ground available at your lightning arrestor and ground available on various pieces of equipment connected to the transmitter. Ensure that there is no resistance (near 0 ohms, accounting for multimeter test lead resistance).
2. Physically inspect the lightning arrestor to ensure that all connections are tight. Also look for any sign of scoring or burning (indications of possible damage from earlier lightning strikes).
3. Using binoculars, visually inspect the hardware on the tower. Look for charred, broken or frayed connections and corrosion.

SECTION 3.4: NON-STANDARD MAINTENANCE

This section provides instructions for performing non-standard maintenance on the GV2-10/GV2-7.5 transmitter. This section includes the following topics:

- [Upgrading Software](#)
- [Screen Configuration - see page 3.4.8](#)
 - [Touchscreen Calibration - see page 3.4.9](#)
- [Changing the OS Password - see page 3.4.10](#)
- [Configuring a Mod Loss Backup Preset - see page 3.4.11](#)

Upgrading Software

Periodically, enhancements or improvements to the operating system are identified and made available. Perform a software upgrade, as required, as follows:

NOTE: Nautel recommends you perform a software upgrade at the transmitter site.

NOTE: Nautel provides a transmitter update mechanism by connecting a USB drive to the rear USB ports of the GV2 controller. Nautel will provide instructions on how to create a USB drive and complete the update or provide preprogrammed USB drives with instructions.

NOTE: For port-forwarded transmitters, uploading of the .tgz file must occur locally or on the transmitter side of the router.

Parts and Tools

- Laptop (i.e., local computer for direct connection) or network computer with Windows and Web browser
- Cat5e Ethernet cable
- Upgrade software (*.tgz file), provided via email or web download

Preliminary Checks

1. Determine the current software revision installed via the advanced user interface (AUI). Select Menu/Software/Upgrades to view the current version.
2. Contact Nautel for the most recent software revision and download *.tgz file to a laptop or network location.

3. Maximize the SBC's disk space by deleting the old .tgz files. You can Browse, Upload, Refresh, Delete and Start Upgrade form this screen. See [Figure 3.4.1 on page 3.4.2](#).

Software Upgrade via Remote AUI

The Upgrades page (see [Figure 3.4.1](#)) in the Software menu allows for uploading a suite of software upgrade files (.tgz files) via remote connection. Navigate the page as described below to complete an upgrade.

Figure 3.4.1: Software - Upgrades

The screenshot displays the 'Upgrades' interface. At the top, the 'Current Version' is 'TITAN-4904 1.0.1'. The 'Add Upgrade' section contains a 'From' field with the placeholder 'Select upgrade file to upload' and a 'Browse' button. The 'To' field is set to 'Onboard Filesystem' with a dropdown arrow and an 'Upload' button. Below this is a table titled 'Select upgrade for installation' with a 'Source' column. The table lists three files: 'vs.titan.4.0.0.30.tgz', 'vs.titan.5.0.0.30.tgz', and 'firmware.tgz', all with a source of 'USI'. At the bottom of the interface are three buttons: 'Refresh List' (blue), 'Start Upgrade' (green), and 'Delete Upgrade File' (red).

Select upgrade for installation	Source
vs.titan.4.0.0.30.tgz	USI
vs.titan.5.0.0.30.tgz	USI
firmware.tgz	USI

Select Browse to locate a .tgz file to upload to the transmitter and click Upload to save the file in the Select upgrade for installation field. A status bar will be displayed showing the percentage completed. See [Figure 3.4.2 on page 3.4.3](#).

Figure 3.4.2: File Upload in Progress

The screenshot shows a web interface titled "Upgrades". At the top, there is a grey header bar with the word "Upgrades" in white. Below the header, there is a white box containing a "Current Version" field with the value "6.0.0". Underneath, there is a section titled "Add Upgrade". This section contains two input fields: "From" with the value "vx-upgrade-6.0.0.tgz" and a "Browse" button to its right; and "To" with the value "Onboard Filesystem" and a dropdown arrow to its right, with a red "Cancel" button to the right of the dropdown. Below these fields is a green progress bar that is completely filled, with the text "Uploading 100.00 %" centered inside it. Below the progress bar is a section titled "Select upgrade for installation" which contains an empty, scrollable list box. At the bottom of the interface, there are three buttons: a blue "Refresh List" button, a green "Start Upgrade" button, and a red "Delete Upgrade File" button.

.tgz file shown for reference, software
upgrade file name will differ

When the file is fully uploaded, the file will be displayed in the Select upgrade for installation field. See [Figure 3.4.3 on page 3.4.4](#).

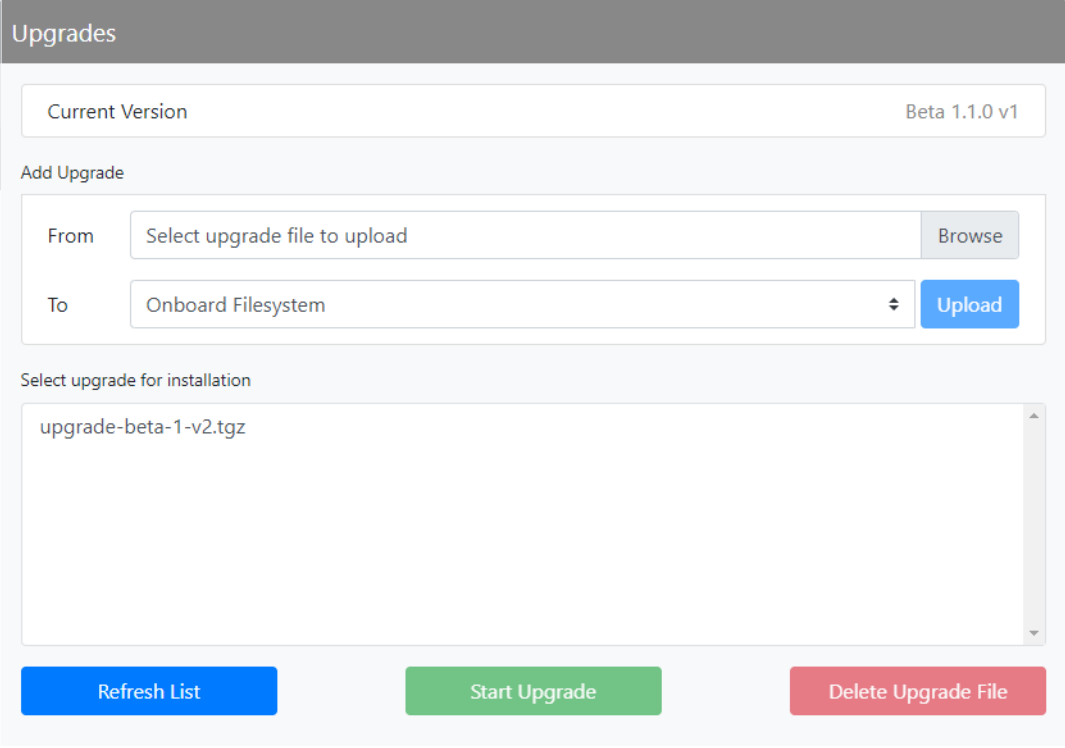
Figure 3.4.3: File Upload field Populated

The screenshot shows a web interface titled "Upgrades". At the top, there is a "Current Version" field displaying "Beta 1.1.0 v1". Below this is an "Add Upgrade" section with two input fields: "From" (containing "Select upgrade file to upload" and a "Browse" button) and "To" (containing "Onboard Filesystem" and an "Upload" button). Underneath is a "Select upgrade for installation" section with a list box containing the file "upgrade-beta-1-v2.tgz". At the bottom of the interface are three buttons: "Refresh List" (blue), "Start Upgrade" (green), and "Delete Upgrade File" (red).

Select the upgrade file from the list and click Start Upgrade to initiate the software upgrade process. A warning will be displayed, indicating that the upgrade can take up to fifteen (15) minutes to complete and cannot be stopped once started. Also, the transmitter can remain in an on-air state during the upgrade. Press Yes to start the upgrade process or Cancel to not proceed with an upgrade. See [Figure 3.4.4](#).

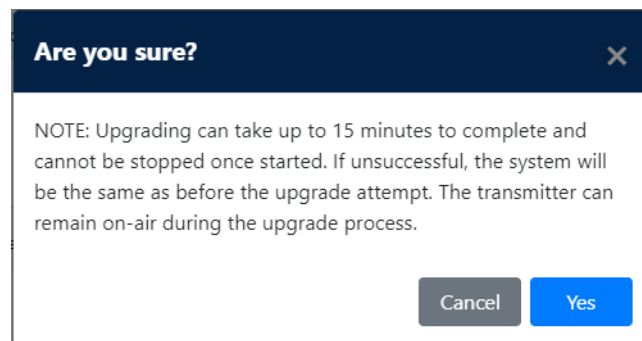
Figure 3.4.4: Upgrade Warning

A status bar will be displayed showing the percentage completed. See [Figure 3.4.5](#) on page 3.4.5.

Figure 3.4.5: File Upgrade in Progress

The screenshot displays a web interface titled "Upgrades". At the top, a grey header bar contains the word "Upgrades". Below this, a white box shows "Current Version" as "6.0.0". Underneath is a section labeled "Add Upgrade". It features a "From" field with the text "vx-upgrade-6.0.0.tgz" and a "Browse" button. The "To" field is set to "Onboard Filesystem" with a dropdown arrow and a red "Cancel" button. A green progress bar below the "To" field indicates "Uploading 100.00 %". Below the progress bar is a section titled "Select upgrade for installation" with an empty list box. At the bottom of the interface are three buttons: a blue "Refresh List" button, a green "Start Upgrade" button, and a red "Delete Upgrade File" button.

A notification will be displayed if the upgrade was successful or has failed.

If the upgrade was successfully completed, the transmitter will require a reboot. Click the Reboot button or the link in the top banner to start the reboot process. See [Figure 3.4.6 on page 3.4.6](#).

Figure 3.4.6: File Upgrade Complete/Reboot

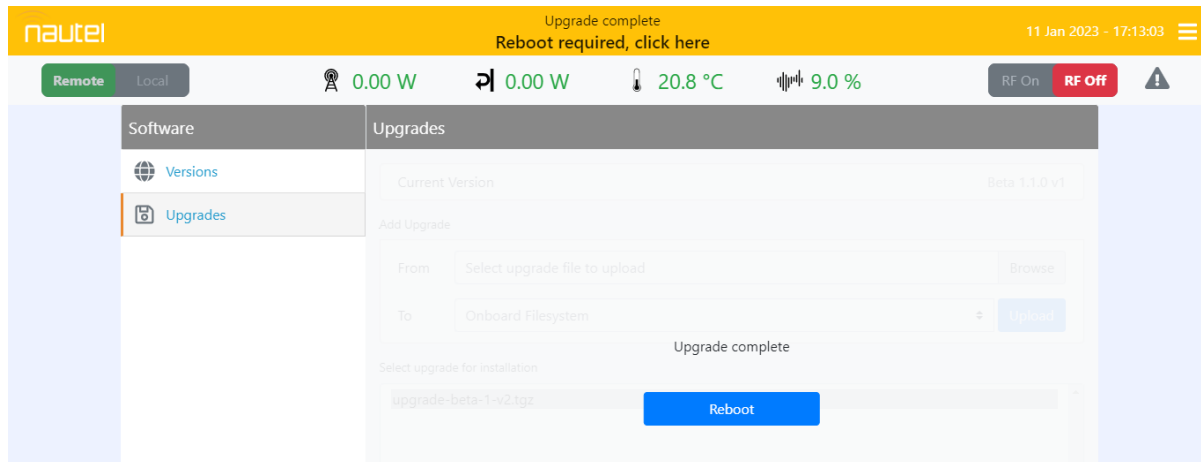

A warning will be displayed, indicating that the transmitter will be off-air for up to two (2) minutes during a reboot. Press Yes to reboot that transmitter or Cancel to revert to the previous software. See [Figure 3.4.7](#).

NOTE: If a firmware update is included in the update, RF off time may be extended depending on the transmitter model (larger models taking longer). Please **do not** AC cycle the transmitter until the internal SBC has rebooted and the AUI is accessible.

Figure 3.4.7: Reboot Warning

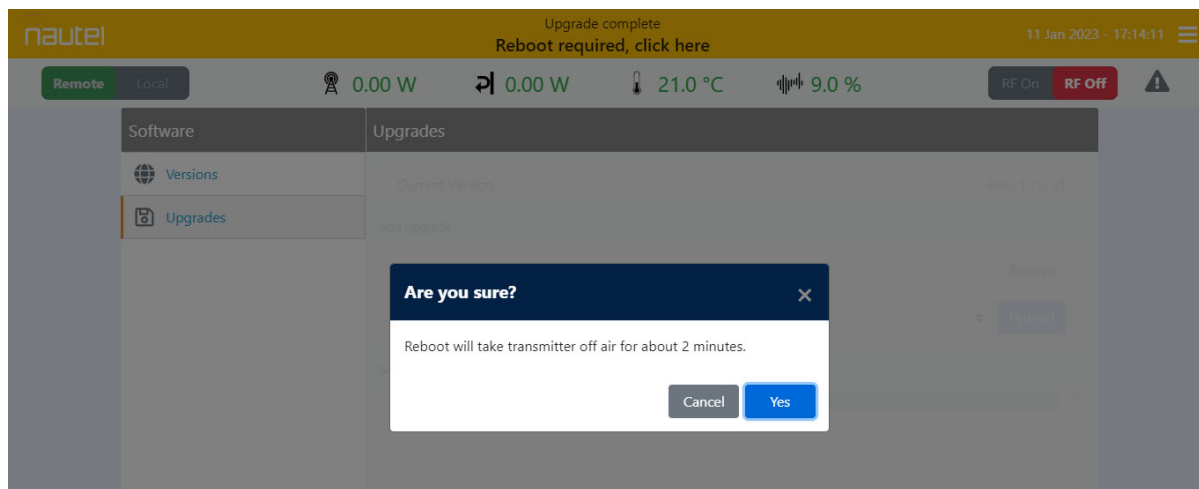

If the upgrade failed, the Operating System will remain unchanged and a pop-up screen will be displayed for the user to acknowledge the failed attempt.

Clicking on Refresh List will show the user all upgrade files currently available. To delete an upgrade file from the list, select the desired file and click Delete Upgrade File. See [Figure 3.4.1 on page 3.4.2](#).

Once rebooted, you will have to log back into the transmitter, using your Username and Password. Refer to [Logging into the AUI - see page 3.2.10](#).

Screen Configuration

NOTE! The Screen Configuration menu is only visible in Local mode.

The Screen Configuration page allows users to enable a Screen Saver and set the Screen Saver Timeout for the front panel display or perform a touchscreen calibration. See [Figure 3.4.8](#).

Figure 3.4.8: Screen Configuration Screen

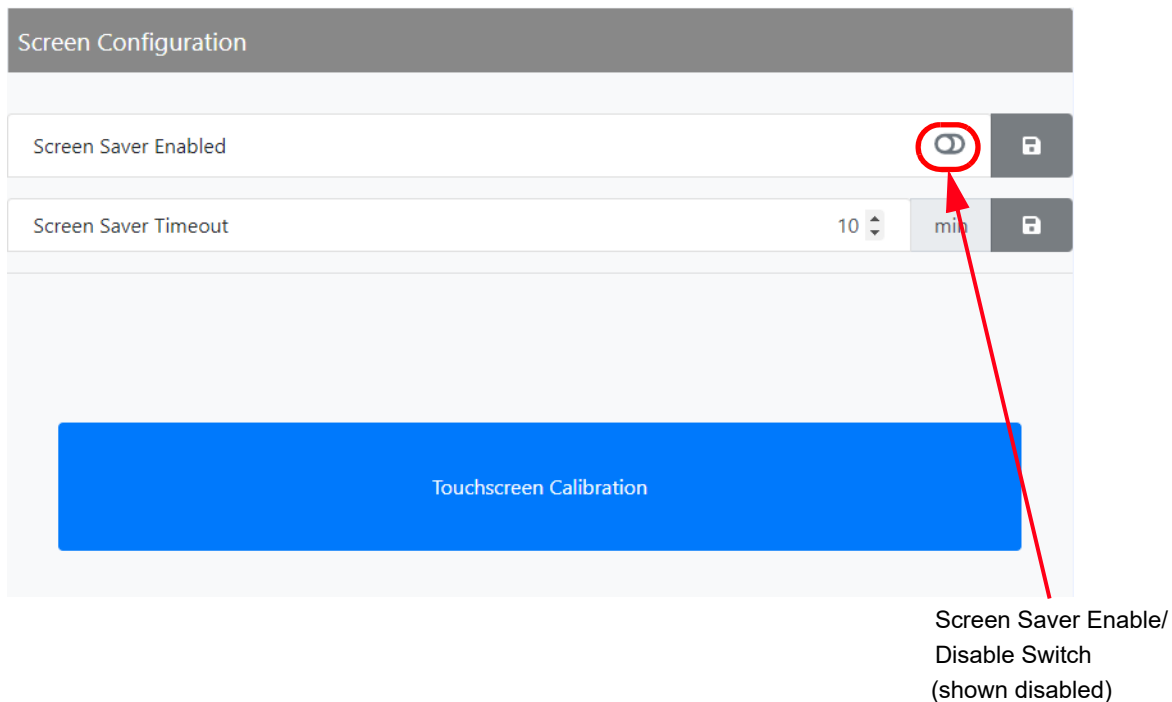

Enable the Screen Saver by sliding the Icon to the right (turns green) and click the Save button.

Use the up and down arrows to change the Screen Saver Timeout and click the Save button. The range is between 10 and 180 minutes.

Touchscreen Calibration

A touchscreen calibration will be required if the AUI or the controller's internal solid-state drive (SSD) has been replaced. To perform a touchscreen calibration, perform the following steps:

- plug a USB mouse into Single Board Computer (SBC).
- put the transmitter in local mode.
- using the mouse, select "Settings" then "Screen Configuration" from the main menu screen.
- select "Touchscreen Calibration".
- follow the on-screen prompts to calibrate the touchscreen by pressing on the X's where instructed to do so.

Changing the OS Password

The OS (operating system) password is a unique, factory set password that is recorded in the OS Password document provided with the transmitter. It should not be necessary to change this password unless there has been a network security breach and access to the transmitter is compromised.

To change the OS Password, you will need to remotely connect to a Linux computer using SSH. PuTTY is a common utility for Windows users (available at <ftp://www3.nautel.com/Utilities/putty/putty.exe>; if unable to open this link, use a search engine to find new URL), while Linux users can use 'ssh' from the command line. Change the OS password as follows:

1. Connect to the transmitter IP address using your selected SSH client.
2. Login with username root and the OS Password provided with your transmitter on the OS Password document.
3. At the prompt, type the command `passwd`. This is the Linux command to change your password.
4. Enter and confirm your new password.
5. Record your new password on the OS Password document provided with the transmitter. If you would like Nautel to track your password for support purposes, please email support@nautel.com with your new information.
6. Close the console window.

Configuring a Mod Loss Backup Preset

The GV2-10/GV2-7.5 contains an audio level detection circuit that can be used, when enabled, to allow switching to a secondary (backup) audio input source upon the loss of the primary source. Configure the desired transmitter preset to perform this function as follows (refer also to Section 2 of this manual for operating instructions of the AUI (local or remote) and controller UI (local) interfaces:

NOTE: You must configure a minimum of two presets to allow this feature to operate. One preset will act as the primary, or normal operating preset. The second preset will act as the secondary, or backup audio preset. Configure the backup audio preset first.

Configuring the Backup Audio Preset

1. Consider the following limitations when selecting a backup preset:
 - ❖ If the exciter has an Orban Inside installed and enabled, then only one AES source can be used for either the primary or backup source.
 - ❖ If MPX over AES is used for either the primary or backup, the other source cannot be AES (either primary or secondary).
 - ❖ If MPX SCAs are enabled, then audio backup cannot be used with MPX as either the main or backup source.
2. From the transmitter AUI, go to Presets/Other Settings and enable Mod Loss Timeout. See [Figure 3.4.9 on page 3.4.12](#). When enabled, other parameters have to set. They are as follows (refer to [Other Settings on page 3.2.59](#)):
 - Mod Loss Action (Alarm Only, RF Inhibit and Change Preset)
 - Mod Loss Preset
 - Mod Loss Timeout (Minutes and Seconds)
 - Mod Loss Threshold (typically 10%)
3. Select a suitable preset to use as the backup audio preset.
4. Click the Save button.

Figure 3.4.9: Presets/Other Settings - Mod Loss Enabled

Update Preset		
General Audio SCA RDS Other Settings		
Pilot Level	10.0	%
Pilot 1 PPS Sync	Disabled	
Audio Delay	Disabled	
Mod Loss Timeout	Enabled	
Mod Loss Action	Change Preset	
Mod Loss Preset	Preset 6	
Mod Loss Timeout Minutes	0	min
Mod Loss Timeout Seconds	5.0	s
Mod Loss Threshold	0	%

5. From the transmitter AUI, go to Presets/Audio and enable Backup Audio. See [Figure 3.4.10 on page 3.4.13](#). When enabled, other parameters have to set. They are as follows (refer to [Main Audio on page 3.2.48](#)):

- Backup Audio Source (Analog L/R, MPX, AES/EBU, Audio Player to AES2 and MPX over AES)
- Backup Analog Level
- Backup Audio Mode (Mono L+R, Mono L, Mono R and Stereo)
- Backup Pre-emphasis (enabled or disabled)
- Backup Audio Gain Adjust

NOTE: SCA, RDS and Pilot modulation levels are additive and contribute the audio level. If their combined levels exceed the audio loss threshold level, a preset change will not occur. Stations with audio content containing extended nulls or silent periods (e.g., classical music) should consider reducing the audio loss threshold or increasing the timeout period.

6. Click the Save button.

Figure 3.4.10: Backup Preset Main Audio Screen

Update Preset

General **Audio** SCA RDS Other Settings

Main Audio	
Audio Source	AES/EBU
Digital Level	0.0 dBFS
Audio Mode	Stereo
15 kHz Low-Pass	Disabled
Pre-emphasis	0 µs
Gain Adjust	0.0 dB
Backup Audio	
Backup Audio Source	Analog L/R
Backup Analog Level	0.0 dBu
Backup Audio Mode	Mono L+R
Backup Audio 15 kHz Low-Pass	Disabled
Backup Pre-emphasis	0 µs
Backup Audio Gain Adjust	0.0 dB

Cancel Save

SECTION 3.5: LIST OF TERMS

This section defines some of the terms that are used in Nautel documentation.

AES/EBU. Audio Engineering Society/European Broadcasting Union (AES/EBU) is the name of a digital audio transfer standard. The AES/EBU digital interface is usually implemented using 3-pin XLR connectors (the same type connector used in professional micros). One cable carries both left-channel and right-channel audio data to the receiving device.

AUI. The Advanced User Interface is the local touch screen on the front door and the advanced remote control/monitoring feature that allows for extensive remote control and monitoring of the transmitter.

CUTBACK. A reduction in RF output power, caused by the occurrence of multiple shutbacks within a pre-defined period.

DHCP. Dynamic Host Carrier Protocol.

DSP. Digital Signal Processing.

EEPROM. Electrically Erasable Programmable Read-Only Memory.

FOLDBACK. A reduction in RF output power, caused by adverse load conditions (high VSWR). No shutbacks or cutbacks have occurred.

LED. Light Emitting Diode (also referred to as lamp).

LVPS. Low Voltage Power Supply. A module or modules used in the ac-dc power stage that generates the low level dc supply voltage for the transmitter.

PRESET. A setting that controls power level, frequency and audio parameters. The GV2-10/GV2-7.5 allows you to pre-program multiple presets.

PWB. Printed Wiring Board.

SHUTBACK. A complete, but temporary loss of RF output power, caused by any one of a variety of faults, including high VSWR, high reject load power, RF drive failure, or an open external interlock.

SHUTDOWN. A complete and permanent loss of RF output power. Typically follows repeated cutback, foldback or shutback events.

SURGE PROTECTION PANEL. An electrical panel that protects equipment from electrical surges in the ac power supply, antenna or site ground caused by lightning strikes.

UI. The User Interface is the controller module's front panel LCD screen that allows for extensive local control and monitoring of the transmitter.

VSWR. Voltage standing wave ratio. This is an expression of the ratio of reverse voltage to forward voltage on the feedline and antenna system. An ideal VSWR of 1:1 provides maximum transmitter-antenna efficiency.

GV2-10/GV2-7.5 OPERATIONS & MAINTENANCE MANUAL

Document: NHB-GV7.5-GV10-OPS

Issue: 2024-05-01

Nautel Limited

10089 Peggy's Cove Road
Hackett's Cove, NS Canada B3Z 3J4

Toll Free: +1.877.6NAUTEL (662.8835)
(Canada & USA only) or

Phone: +1.902.823.3900 or

Fax: +1.902.823.3183

Nautel Inc.

201 Target Industrial Circle
Bangor, Maine USA 04401

Phone: +1.207.947.8200

Fax: +1.207.947.3693

Customer Service (24-hour support)

+1.877.628.8353 (Canada & USA only)

+1.902.823.5100 (International)

Email: support@nautel.com

Web: www.nautel.com

© Copyright 2024 NAUTEL. All rights reserved.

