



NX100 - Kolkata B
Main-Standby Transmitter
System

All India Radio (AIR)

APPENDIX C

ANTENNA TUNING UNIT

Issue 0.2 09 October 2014

Nautel Limited
10089 Peggy's Cove Road,
Hackett's Cove, NS, Canada B3Z 3J4
T.877 6 nautel (628835) or +1.902.823.2233
F.+1.902.823.3183 info@nautel.com

U.S. customers please contact:
Nautel Inc.
201 Target Industrial Circle, Bangor ME 04401
T.877 6 nautel (628835) or +1.207.947.8200
F.+1.207.947.3693 info@nautel.com

e-mail: support@nautel.com
www.nautel.com

INSTALLATION INSTRUCTIONS

FOR RF EQUIPMENT TO BE INSTALLED
IN TUNING HUT AT THE
1008 kHz STATION

AIR SITE PROJECT

KOLKATA
B

Kintronic Laboratories, Inc.
Bristol, TN

Table of Contents:

Table of Contents:.....	2
Tools and Materials Required:.....	3
General Instructions.....	3
Inventory and Staging of Parts.....	4
Building Measurements.....	4
Overview of Installation Steps.....	6
Detailed Installation Procedure.....	7
A. Floor Layout Panels.....	7
B. Critical Overview of Component Installation.....	8
C. Installation of Floor-Mounted RF components.....	9
D. Installation of Copper Pipe Bus-Work.....	10
E. Installation of Vacuum Capacitors.....	11
F. Installation of Auxiliary Equipment.....	12

Tools and Materials Required:

(Not supplied by KTL):

1. Duct Tape or similar adhesive tape, for securing the floor layout panels
2. Masonry drill bits, suitable for drilling in concrete (1/4" or metric equivalent and recommended)
3. Vacuum cleaner for cleaning out drilled holes in concrete.
4. 1/4" Hardware anchors suitable for use with concrete or similar, as appropriate for the actual construction material used to construct the Tuning Houses.
5. "English" –sized Allen wrench set
6. "English" –sized wrench set
7. Hammer
8. Drill capable of drilling concrete
9. Tin Snips
10. Screw Driver Set
11. Flux
12. Silver Solder
13. Crescent Wrenches
14. Oxygen and Acetylene Torch Set

(Supplied by KTL):

15. Hardboard Floor Layout Panels
16. Drawings used for component layout, measurements, and assembly of parts – included in this installation manual.
 - a. B Site RF Schematic KTL Dwg A-6230-KOB
 - b. B Site Component Layout KTL Dwg A-6246-KOB
 - c. B Site Floor Panel Layout KTL Dwg C-4258-KOB
 - d. B Site Layout KTL Dwg C-4258-KOBS
17. RF Components as specified in RF Schematic.

General Instructions

These instructions are to be used in conjunction with the final drawing package for the ATU Network supplied by Kintronic Labs (KTL) for installation at the tower base.

Before beginning the actual installation process, it is recommended that these instructions be read through in their entirety, and also that the drawings referred to in the instructions are reviewed in connection with the specific steps in which these drawings are referenced.

Inventory and Staging of Parts

Next, to prepare for the installation process, it is important to insure that all of the parts and components are accounted for, and ready to be used when needed. An appropriate location (such as the Transmitter Building) should be used as a staging area.

Using the RF Schematic and the Component Layout Drawing, a complete inventory should be made of the components and checked against the drawings for completeness. These include:

- coils mounted on component panels
- component panels for capacitors
- capacitors in boxes (NOTE: keep all capacitors in their respective protective boxes until it is time to install them per the instructions)
- Arc Gap Assemblies
- Grounding Switch Assemblies
- Meters and meter toroids (keep meters in boxes until installation)
- Hardware, and other misc. parts

Make a complete inventory of all of the interconnecting bus-work pipe sections, each of which has been wrapped and labeled individually. Keep the pipe sections in their protective wrap until it is time to install in the system.

Building Measurements

These instructions have been written with the underlying assumption that the building size correctly matches the dimensions indicated on the KTL drawing set, that the walls are plumb and vertical, that the wall-to-wall and wall-to-floor interfaces are square, and that all mounting surfaces are flat and even.

Since these dimensions are critical for the successful installation of the equipment, the following measurements should be made before bringing any parts or equipment into the ATU building. **NOTE: If any discrepancies are discovered, KTL should be contacted immediately, in order to determine the impact they have on the installation process, and whether corrective action or changes will be advised.**

Measure all dimensions of the building interior, and compare to the dimensions as indicated on the relevant drawings. In particular, measure the interior width of the building at both the front end and at the rear end of the building, and also measure the interior depth of the building on both right and left sides of the building.

Take note of the locations of the openings in the wall for the RF input (which will connect to the transmission line from the Transmitter Building) and the RF output (which provides the interface to the Tower. Measure the size of each opening, and make measurements needed to determine its exact location, and compare these measurements to the KTL layout drawings.

Note: If floor dimensions deviate from those indicated on the KTL Component Layout Drawing by more than 2.5 cm (1 inch) for either the length or the width, please contact KTL or designated representative to discuss the best means of compensating for the discrepancy during the assembly and installation process.

Overview of Installation Steps

Before presenting the detailed installation steps, the present section presents an overview of the basic approach that will be taken in the installation of the RF equipment into the ATU building.

The basic steps to be taken are as follows:

1. Inventory the components and parts needed for the assembly, and carefully measure the interior of the building to verify dimensions. (These steps are covered above in “General Instructions.”)
2. Place the Hardboard Floor Layout Panels onto the floor.
3. Drill the mounting holes into floor using Floor Layout Panels as a template.
4. Remove the Floor Layout Panels one at a time, and mark onto the concrete floor the identification, orientation and position of each floor-mounted component appearing on each Floor Layout Panel, as each panel is removed.
5. Become familiar with the pictures showing the factory mock-up of the ATU and review these pictures against the RF schematic and the Component Layout drawing.
6. Starting with the reference corner of the building, place component panels on the floor.
7. Verify correct placement by temporarily installing associated bus-work pipe between components.
8. Remove any interconnecting pipe that was temporarily connected to components, and then remove the floor-mounted components that were used in the previous step.
9. Install the Safety Screen wall, and secure with hardware.
10. Install the Floor-mounted component panels, and secure with hardware.
11. Install the interconnecting bus-work pipe sections for the floor-mounted components.
12. Install the capacitors onto their component panels.
13. Check out entire RF system as assembled and compare to the RF schematic and relevant KTL drawings.
14. Install the auxiliary components and equipment (meters, grounding switches, arc gaps, etc.)

Detailed Installation Procedure

A. Floor Layout Panels

1. Refer to the ATU floor layout drawing. This drawing provides an overall dimensional view of the major structural elements of the ATU building, without the RF components. This drawing also shows the placement of the input and output panels relative to the rest of the building.
2. Locate the 4' x 8' x 1/8" Hardboard panels that will be used as a layout pattern for the floor of the ATU RF components. Referring to the ATU floor layout drawing, the panels should be placed tightly together leaving no spaces between the panels. The proper placement of the components has been marked on the panels, and these markings can also be used as a guide to ensure that the panels are correctly placed. Duct tape or similar adhesive tape may be used to secure the Hardboard panels into place, once they have been all correctly placed.

Note the location in the drawing for the "Reference Corner", and the locations of the RF input and the RF output for the ATU building. Also refer to the photos of the factory mockup of the system for which the components have been removed from the floor, leaving only the Hardboard template.

3. After the Hardboard layout pattern is fully assembled and secured, pre-drill all the marked hole locations for each panel with a 5/16" nominal drill bit through Hardboard material and copper if necessary. Make sure the holes are drilled vertical to the floor and are drilled completely through the Hardboard, and then using 1/4" masonry drill bit (or nearest size that corresponds to the concrete anchor bolt sizes that will be used.), drill anchor holes in the concrete floor using Hardboard template. The holes must be drilled to the appropriate depth dictated by the concrete anchors being used to secure the panels to the concrete floor.
4. When all of the marked hole locations have been pre-drilled, remove the Hardboard sheets one at a time. As each Hardboard sheet is removed, mark each component number on the floor for the placement of each component.
5. Make sure all of the mounting holes have been drilled to the correct depth for all mounting holes in the floor. When all the holes have been drilled, clean out the debris from the holes with a vacuum cleaner. Then, install the hardware anchors into the holes in the concrete for each component panel. To ensure that all of the holes have been included, do this for only one component panel at a time.

B. Critical Overview of Component Installation

1. This is an important overview section, which will make it easier to identify each RF component in the system, and also ensure that each component will be located in its proper position and orientation. While going through this overview section, refer to the RF schematic and Component Layout Drawing.
2. The Component Layout Drawing shows the correct placement of all the RF components.
3. The set of factory photos of the ATU network mockup provide numerous examples of the components mounted on their respective component panels, as well as the identifying labels that are used on all components and all relevant drawings. An example photo noting typical ATU components is given below (Note the photo is not for this particular system, but is a representative factory photo).

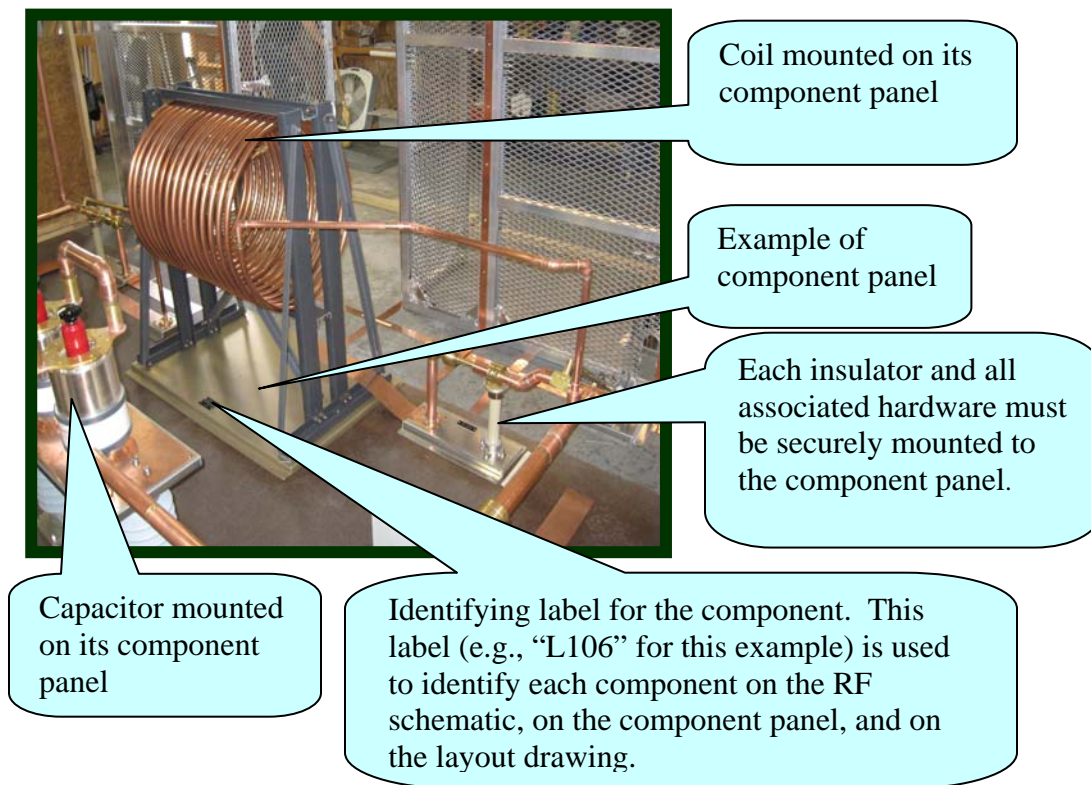

Figure 1: Component Panel details

4. While using the factory mockup photos as a guide, trace through the RF schematic for the ATU system, starting at the RF input, and working through to the RF output. As the components are identified in the RF schematic, the corresponding location of the component should be identified in the component layout drawing, and also observed in the corresponding photo(s).
5. During the actual installation of the components, which is covered in the following sections, the factory mockup photos should be referred to as needed for clarification.

D. Installation of Floor-Mounted RF components

1. Refer again to the ATU floor layout drawing, showing the correct placement of all the RF components.
2. Make sure all of the mounting holes were drilled to the correct depth for anchoring the floor-mounted components, and that all the holes have been cleared of debris using the vacuum cleaner.
3. When all the holes have been drilled and vacuumed, install the hardware anchors into the holes in the concrete for each component panel. To ensure that all of the holes have been included, do this for only one component panel at a time.
4. Find all the floor-mounted component panels, as labeled on the drawing. Make sure all insulators and hardware are securely mounted on each component panel. Install each component panel as shown in the ATU floor layout drawing. Make sure each component is oriented in the correct direction (refer to photos as needed).
5. **Note: Do not install any of the capacitors yet. Only install the component panels at this time. The capacitors will be mounted on these panels in a later step.**
6. The correct orientation for each component may be determined by carefully examining the photographs from the factory mockup of the ATU. The final verification of the correct position and orientation will be made when the interconnecting copper pipe sections are installed. In order for the copper pipe sections to mate properly with the components, the components must be positioned and oriented correctly.

E. Installation of Copper Pipe Bus-Work

1. Locate the copper pipe for the RF components. Each piece of copper pipe is labeled on the outside of the protective wrapping to show which components are to be connected with that particular piece of pipe. When you remove the protective wrapping you will see that each end of the pipe has also been marked so as to indicate the component that it connects to on that end of the pipe.
2. Install the pipe sections for the interconnections between each component, ensuring the label on the copper pipe (hand marked in ink) and the component numbers (engraved tag on panel) match correctly. Make sure all the connections are tight.
3. Many of the pipe sections are connected together through the use of “splitters.” The splitters are used to allow for small length adjustments. Each splitter will allow for an adjustment of up to ~ 1 cm. If a greater adjustment than this is required, it is possible that adjustments in positioning might be required somewhere else in the system. A splitter is illustrated below.

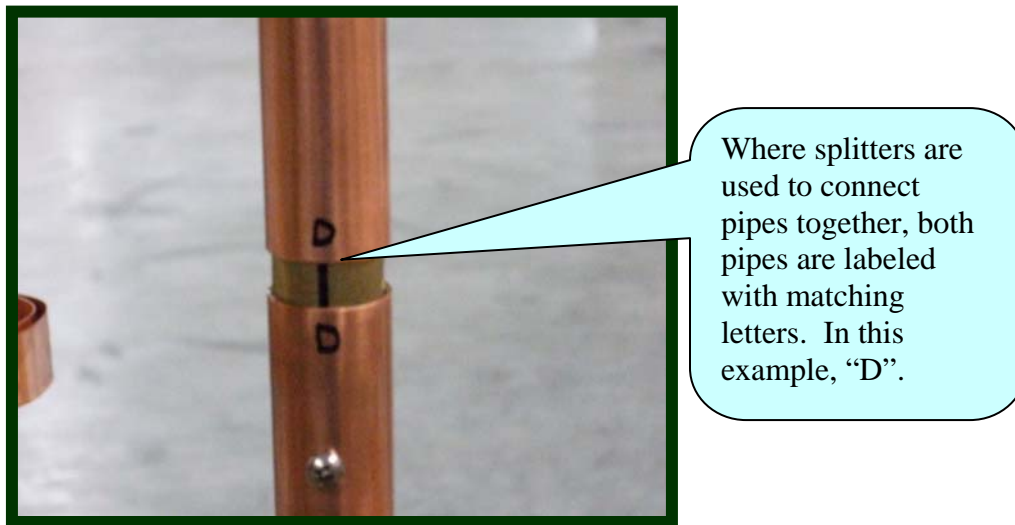

Figure 3: Example of bus work splitter

4. After all of the pipe sections have been secured, go through the system and make sure that all the splitter connections have been tightened.

F. Installation of Vacuum Capacitors

1. Reserve the actual installation of the capacitors themselves until it is absolutely necessary. This will help prevent damage to the capacitors. The vacuum capacitors used throughout this system are both **fragile** and **expensive**. They should be handled carefully to prevent damaging them.
2. First install the variable capacitors. Note that variable capacitors must be installed with the knob oriented in the proper direction. Most variable vacuum capacitors will be packed with the mounting plate factory installed on the end of the capacitor that has the adjustment knob. For the few that may not, note that one of the two mounting plates or brackets will have a large clearance hole in the center. The end of the capacitor with the adjustment knob must mount on this plate so that the knob passes down through this clearance hole. Refer carefully to the factory mockup photos to ensure that the variable capacitors are being oriented properly.
3. After the variable capacitors have been installed, locate any fixed capacitors in the system and install them on their appropriate locations. Install each capacitor in its proper location by matching the component labels and referring to the factory mockup photos.
4. For each of the capacitors, make sure that all of the hardware has been tightened.
5. Refer to the RF schematic. After all of the capacitors have been installed, use the RF schematic to trace through the entire RF network, to ensure that all the interconnections correctly match the schematic. Make sure that all hardware has been tightened properly.

G. Installation of Auxiliary Equipment

1. Locate the remote meters for the input and output RF current.
2. Each meter has been calibrated together with its toroid and cable as a matched set. Use the serial numbers to match each meter with the correct transformer.
3. For each meter/toroid combination, temporarily route the cable that connects them to make sure that the cable routing allows a proper connection on each end without causing stretching or strain of the cable. When a suitable routing has been determined, the cable can then be routed and secured properly. Note that the cable must remain tight against the copper wall/floor or in grounded conduit for protection.
4. Mount the meters in the correct hole marked by the labels on the front of the safety screen wall.
5. The factory mockup photos will show the locations of the meters.
6. A typical example photo showing the meters mounted is below. This shows the meters as seen from inside the RF compartment. The meters are to be read and operated from the safe side of the safety screen wall.

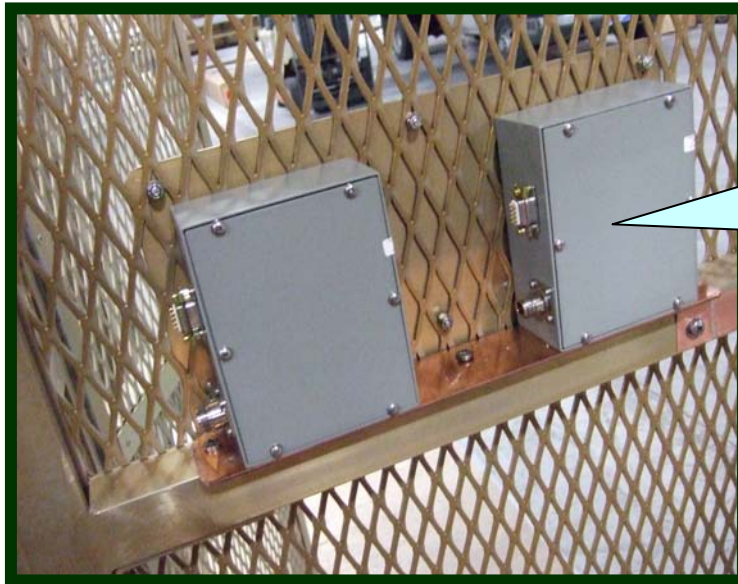

Close-up of back of RF current meters from the inside of safety screen wall

Figure 4: Rear view of meters

This completes the ATU network installation.
Refer questions to Kintronic Labs, Inc. Engineering Dept.

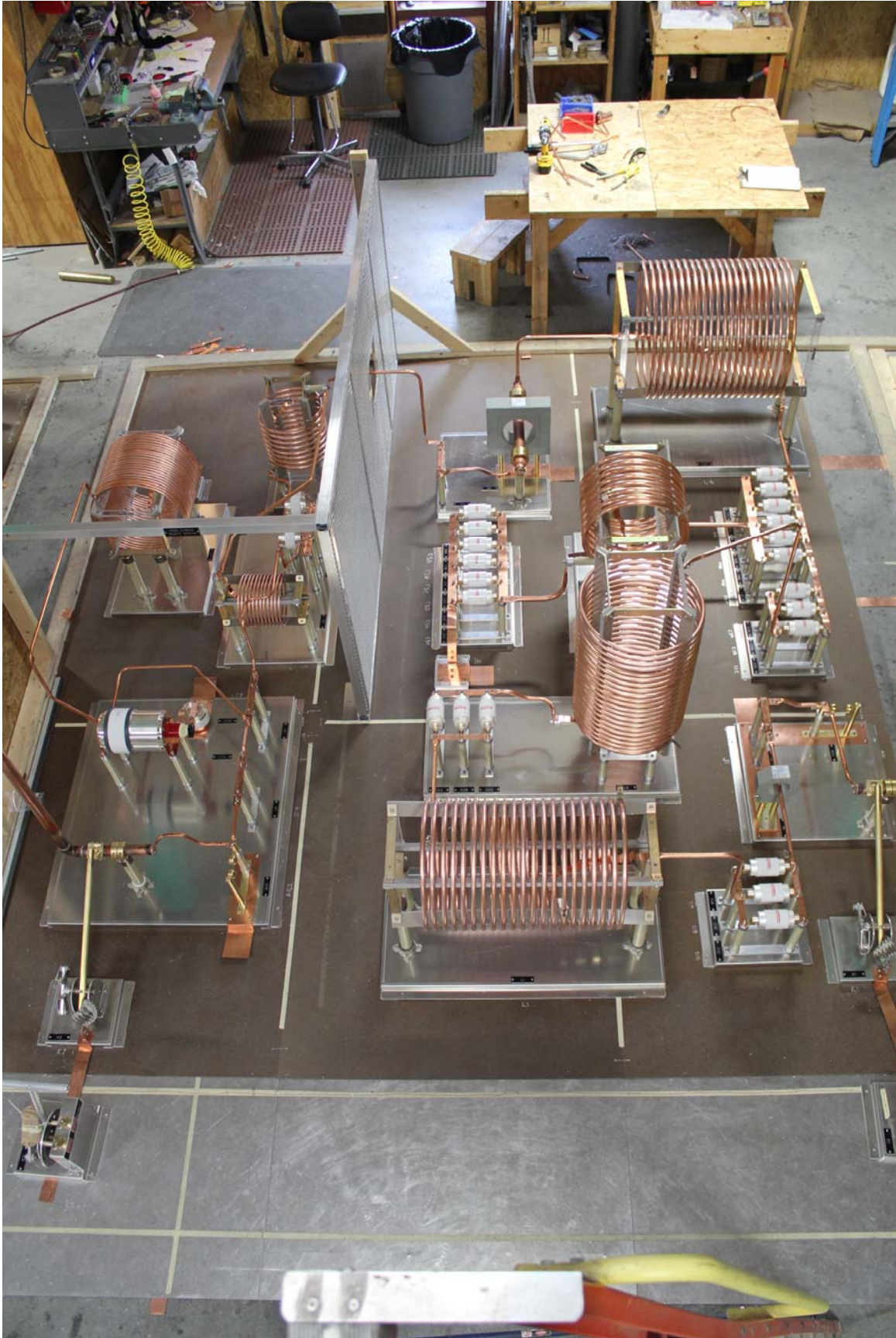



$Z_a = 751 + j14 \ \Omega$
 $P = 100 \text{ KW}$
 $FREQ = 1008 \text{ KHZ}$
 $Z_{in} = 155 - j304 \ \Omega$
 $I_{in} = 25.4 \text{ Arms}$
 $V_{in} = 8,667 \text{ Vrms}$

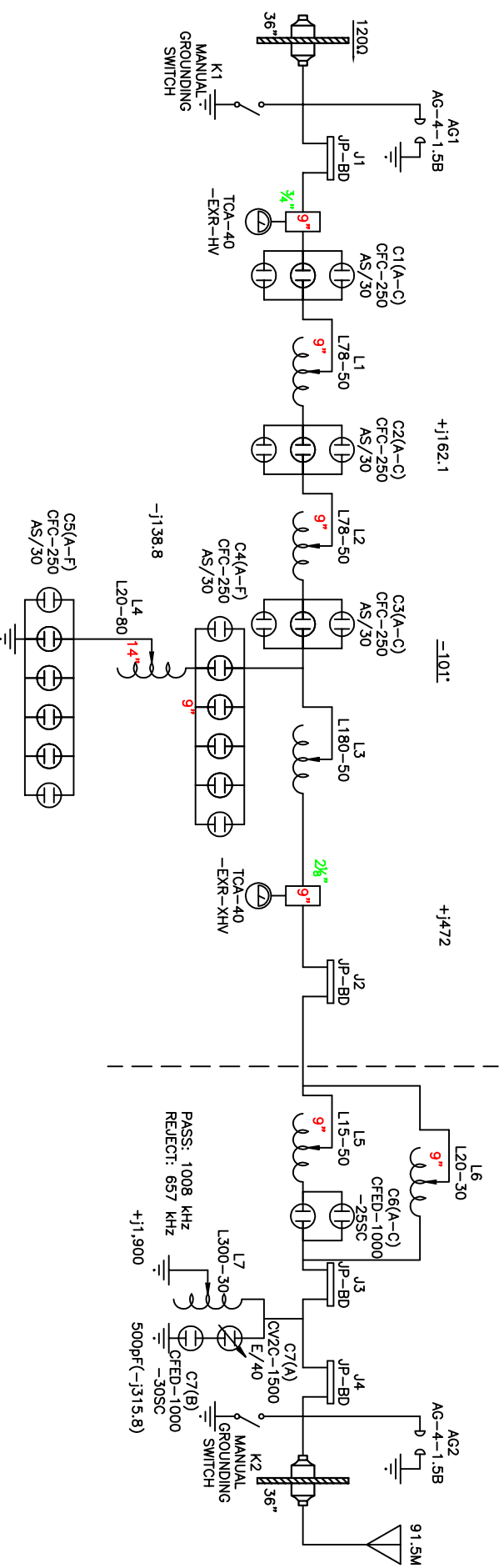

KINTRONIC LABORATORIES INC.
 BLUFF CITY, TN.
COPYRIGHT 2013 KINTRONIC LABORATORIES INC.

NAUTEL AIR KOLKATA B SITE
 1008 KHZ, 100 KW

REF DWG:	JOB NO:	DRAWN:
C-4258-KOB		B.S.W.
REV:	DESIGNED:	APPROVED:
16-Dec-13	J.M.	
DWG NO:	DATE:	SCALE:
A-6230-KOB	6-May-13	N.T.S.

LEGEND:
 5/8" TUBING THROUGHOUT, EXCEPT FOR 1 1/8" PIPE AT MANUAL GROUNDING SWITCHES.
 7/8" IN SHUNT BRANCH OF T-NETWORK, AND SIZED AS SHOWN THROUGH TCA METER TOROIDS.
 9" INSULATORS W/ ENDCAPS THROUGHOUT, EXCEPT WHERE NOTED OTHERWISE.

NOTES:
 1. MOCKUP USING LARGE PANELS. (NO SAFETY SCREEN)
 2. MANUAL GROUND SWITCHES TO BE CONTROLLED FROM ENTRY CAGE AREA.
 3. INCLUDE 3RD 1200 WALL FEEDTHRU PANEL FOR TRANSMITTER BUILDING.
 4. THE CONTENTS OF THIS DRAWING ARE THE INTELLECTUAL PROPERTY OF KINTRONIC LABS, INC. AND ARE NOT TO BE DISTRIBUTED TO ANY THIRD PARTY WITHOUT THE WRITTEN CONSENT OF KINTRONIC LABS, INC.

COMPONENT LIST:	X	x	Y
1. INPUT	2.09	x	4.00
2. K1	3.38	x	3.21
3. PANEL A	2.49	x	2.96
4. C1	3.25	x	2.76
5. L1	3.14	x	1.57
6. PANEL B	2.32	x	1.70
7. C3(A-C)	1.95	x	3.05
8. C4(A-F)	1.24	x	3.05
9. L4	1.38	x	2.32
10. C5(A-F)	1.45	x	1.70
11. L3	0.29	x	2.51
12. M2	0.64	x	1.71
13. L5	0.88	x	0.85
14. PANEL C	1.33	x	0.75
15. PANEL D	2.31	x	0.20
16. L7	1.12	x	0.17
17. K2	3.61	x	0.30
18. OUTPUT	2.09	x	0.00

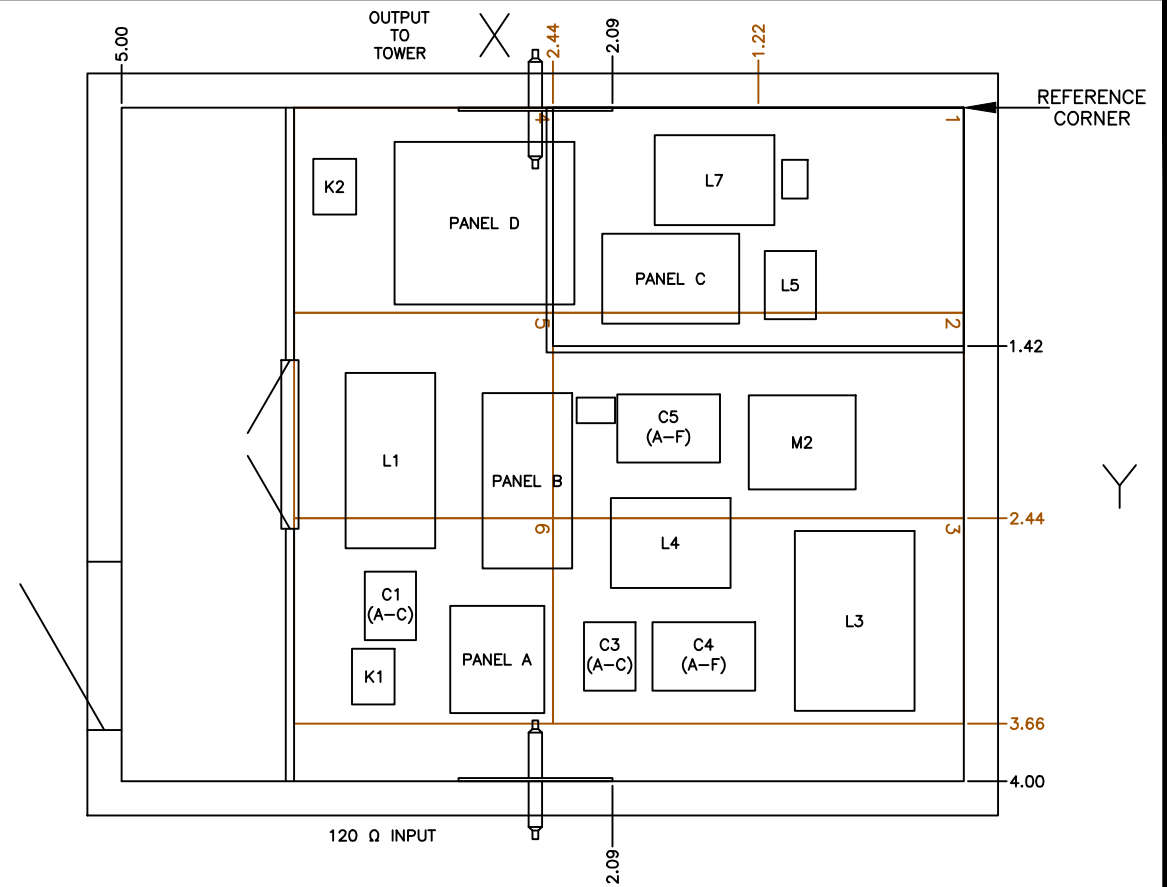

KINTRONIC LABORATORIES INC.
BLUFF CITY, TN.

COPYRIGHT 2014 KINTRONIC LABORATORIES INC.

NAUTEL-AIR KOLKATA B SITE
COMPONENT LAYOUT
1008 kHz, 100 KW

REF DWG: A-6230-KOB	JOB NO:	DRAWN: B.S.W.
REV: 16-May-14	DESIGNED:	APPROVED:
DWG NO: A-6246-KOB	DATE: 16-Jan-14	SCALE: N.T.S.

- NOTES:
1. ALL MEASUREMENTS ARE INTERIOR AND IN METERS UNLESS SPECIFIED OTHERWISE.
 2. THE CONTENTS OF THIS DRAWING ARE THE INTELLECTUAL PROPERTY OF KINTRONIC LABS, INC. AND ARE NOT TO BE DISTRIBUTED TO ANY THIRD PARTY WITHOUT THE WRITTEN CONSENT OF KINTRONIC LABS, INC.

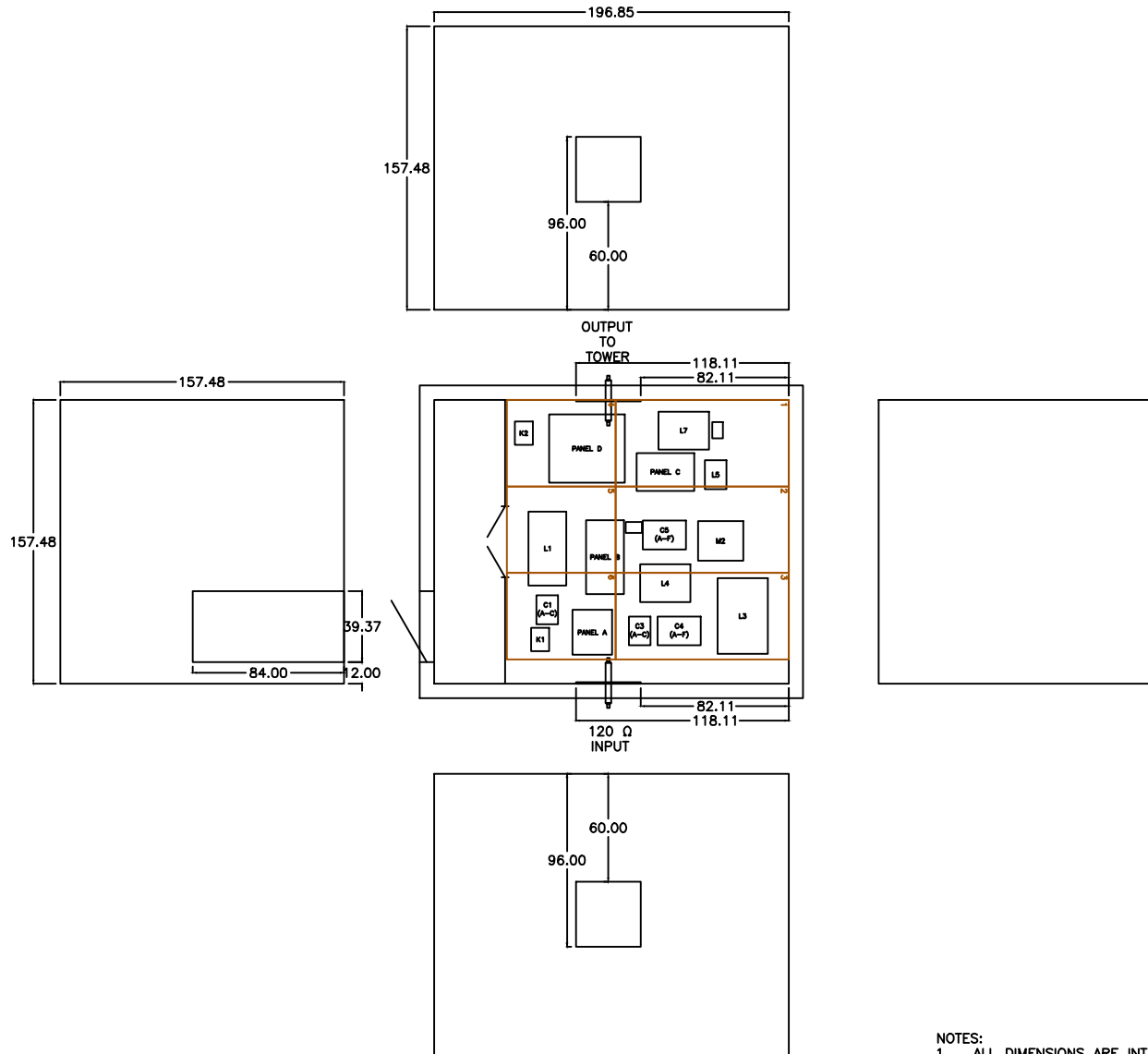

NOTES:
 1. ALL DIMENSIONS ARE INTERIOR AND IN FEET UNLESS OTHERWISE SPECIFIED
 2. THE CONTENTS OF THIS DRAWING ARE THE INTELLECTUAL PROPERTY OF KINTRONIC LABS, INC. AND ARE NOT TO BE DISTRIBUTED TO ANY THIRD PARTY WITHOUT THE WRITTEN CONSENT OF KINTRONIC LABS, INC.

PROPOSED ATU BUILDING
 PRELIMINARY

 KINTRONIC LABORATORIES INC. BLUFF CITY, TN. COPYRIGHT 2013 KINTRONIC LABORATORIES INC.		
NAUTEL - AIR KOLKATA B SITE ATU SHELTER LAYOUT 1008kHz 100 kW		
REF. DWG:	JOB NO.:	DRAWN:
A-6230-KOB		B.S.W.
REV:	DESIGNED:	APPROVED:
16-May-14		
DWG NO.:	DATE:	SCALE:
C-4258-KOB	28-Mar-13	N.T.S.

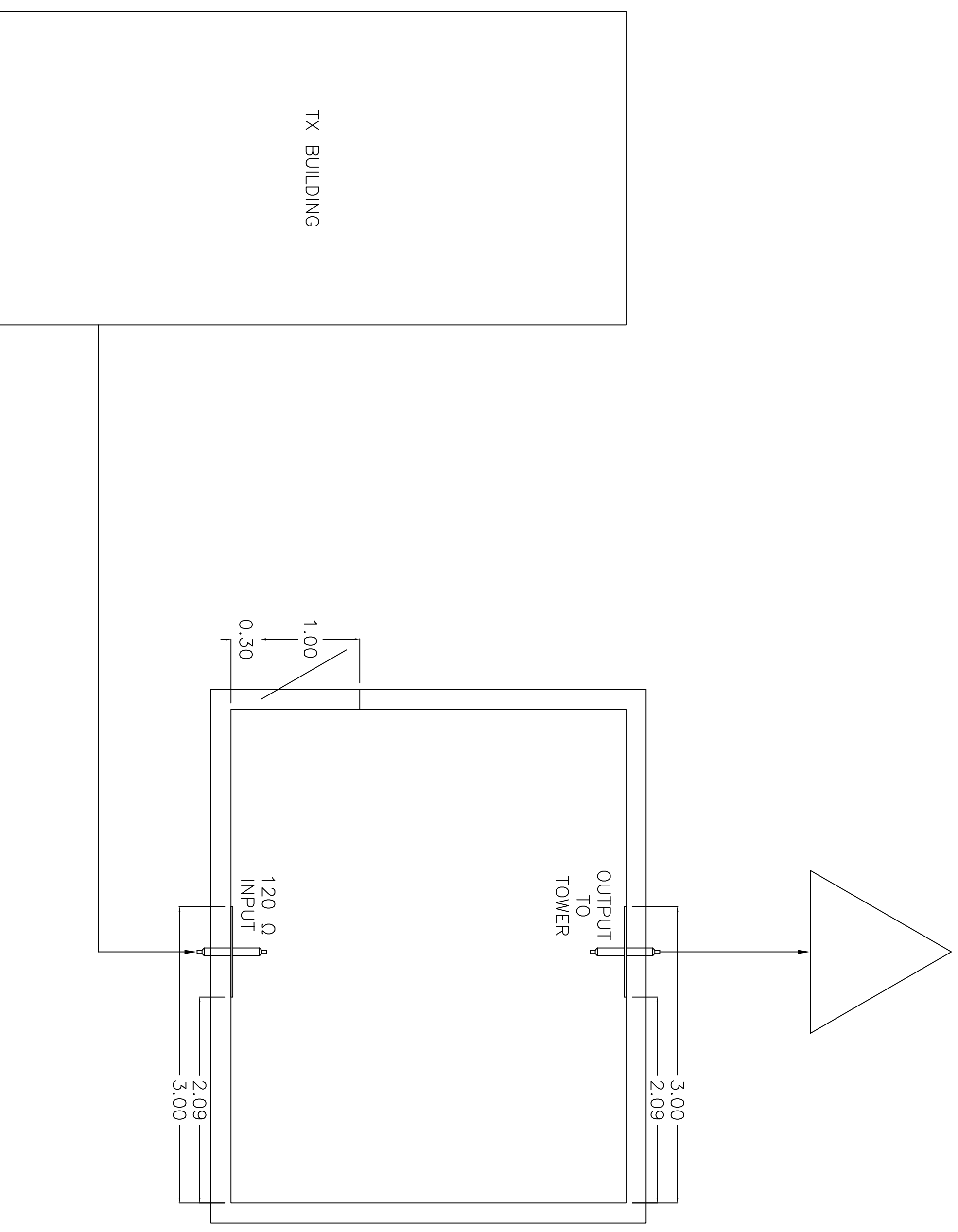

 KINTRONIC LABORATORIES INC. BLUFF CITY, TN. COPYRIGHT 2013 KINTRONIC LABORATORIES INC.			
NAUTEL – AIR KOLKATA B SITE ATU SHELTER LAYOUT 1008KHz 100 KW			
REF DWG:	JOB NO:	DRAWN:	
C-4258-KOB		B.S.W.	
REV:	DESIGNED:	APPROVED:	
27-Sep-13			
DWG NO:	DATE:	SCALE:	
C-4258-KOBS	25-Sep-13	N.T.S.	

ATU Parts Lists

Site Name – KOLKATA ‘B’

Circuit Nomenclature	Part No.	Rated inductance	Rated Current	Component type	Manufacturer
	Coils	(in μh)	(in A)		
L1.	L78-50	78	50	Fixed Inductor	Kintronic Labs.
L2.	L78-50	78	50	Fixed Inductor	Kintronic Labs.
L3.	L180-50	180	50	Fixed Inductor	Kintronic Labs.
L4.	L20-80	20	80	Fixed Inductor	Kintronic Labs.
L5.	L15-50	15	50	Fixed Inductor	Kintronic Labs.
L6.	L20-30	20	30	Fixed Inductor	Kintronic Labs.
L7.	L300-30	300	30	Fixed Inductor	Kintronic Labs.

Circuit Nomenclature	Part No.	Rated Capacitance	Rated Voltage	Component type	Manufacturer
Caps		(in pF)	(in kV)		
C1.					
a.	CFC-250AS/30	250	30	Fixed Vacuum Capacitor	Kintronic Labs.
b.	CFC-250AS/30	250	30	Fixed Vacuum Capacitor	Kintronic Labs.
c.	CFC-250AS/30	250	30	Fixed Vacuum Capacitor	Kintronic Labs.
C2.					
a.	CFC-250AS/30	250	30	Fixed Vacuum Capacitor	Kintronic Labs.
b.	CFC-250AS/30	250	30	Fixed Vacuum Capacitor	Kintronic Labs.
c.	CFC-250AS/30	250	30	Fixed Vacuum Capacitor	Kintronic Labs.
C3.					
a.	CFC-250AS/30	250	30	Fixed Vacuum Capacitor	Kintronic Labs.
b.	CFC-250AS/30	250	30	Fixed Vacuum Capacitor	Kintronic Labs.
c.	CFC-250AS/30	250	30	Fixed Vacuum Capacitor	Kintronic Labs.
C4.					
a.	CFC-250AS/30	250	30	Fixed Vacuum Capacitor	Kintronic Labs.
b.	CFC-250AS/30	250	30	Fixed Vacuum Capacitor	Kintronic Labs.
c.	CFC-250AS/30	250	30	Fixed Vacuum Capacitor	Kintronic Labs.
d.	CFC-250AS/30	250	30	Fixed Vacuum Capacitor	Kintronic Labs.
e.	CFC-250AS/30	250	30	Fixed Vacuum Capacitor	Kintronic Labs.
f.	CFC-250AS/30	250	30	Fixed Vacuum Capacitor	Kintronic Labs.
C5.					
a.	CFC-250AS/30	250	30	Fixed Vacuum Capacitor	Kintronic Labs.
b.	CFC-250AS/30	250	30	Fixed Vacuum Capacitor	Kintronic Labs.
c.	CFC-250AS/30	250	30	Fixed Vacuum Capacitor	Kintronic Labs.
d.	CFC-250AS/30	250	30	Fixed Vacuum Capacitor	Kintronic Labs.
e.	CFC-250AS/30	250	30	Fixed Vacuum Capacitor	Kintronic Labs.
f.	CFC-250AS/30	250	30	Fixed Vacuum Capacitor	Kintronic Labs.
C6.					
a.	CFED-1000/25SC	1000	25	Fixed Vacuum Capacitor	Jennings
b.	CFED-1000/25SC	1000	25	Fixed Vacuum Capacitor	Jennings
c.	CFED-1000/25SC	1000	25	Fixed Vacuum Capacitor	Jennings
C7.					
a.	CV2C-1500E/40	1000	25	Variable Vacuum Capacitor	Comet
b.	CFED-100/30	1000	25	Fixed Vacuum Capacitor	Jennings

ATU Parts Lists

Circuit Nomenclature	Part No.	Rated Current Range	Peak Modulation Voltage	Component type	Manufacturer
Meters/TCTs		(in A)	rms/peak (in kV)		
TCA1.	TCA-40-EXR-HV W	8-40	20/28	Toroidal Shielded Transformer	Delta Electronics.
TCA2.	TCA-40-EXR-XHV W	8-40	42.4/60	Toroidal Shielded Transformer	Delta Electronics.

Circuit Nomenclature	Part No	Component type	Arc Gap	Rated voltage	Manufacturer
Arc Gaps					
AG1.	AG-4-1.5B	Variable Arc Gap	.375" Nominal	80kV Nominal	Kintronic Labs.
AG2.	AG-4-1.5B	Variable Arc Gap	.5" Nominal	80kV Nominal	Kintronic Labs.

Circuit Nomenclature	Part No	Component type	Manufacturer
J-Plugs/Switches			
K1.	K1 Contactor	Manual Ground Switch	Kintronic Labs.
K2.	K2 contactor	Manual Ground Switch	Kintronic Labs.
J1.	JP-BD	J-plug	Kintronic Labs.
J2.	JP-BD	J-plug	Kintronic Labs.
J3.	JP-BD	J-plug	Kintronic Labs.
J4.	JP-BD	J-plug	Kintronic Labs.

**Factory Pre-Tuning Certificate
NAUTEL – All India Radio**

SITE NAME: Kolkata B
POWER: 100 kW
FREQUENCY: 1,008 kHz

Load Impedances:

	<u>Target Values:</u>	<u>Measured Values:</u>
998 kHz	734.2 + j 68.3	735 + j 66
1008 kHz	750.8 + j 14.3	750 + j 14
1018 kHz	758.9 – j 42.6	758 – j 42

Input Impedances:

	<u>At Transmitter Finals*</u>		<u>At Input of Antenna Tuning Unit</u>			
	<u>Predicted Z</u>	<u>SWR</u>	<u>Predicted Z</u>	<u>SWR:</u>	<u>Measured Z</u>	<u>SWR:</u>
998 kHz	8.3 + j 3.6	1.050	117.5 – j 3.0	1.034	115.5 + j 1.2	1.040
1008 kHz	7.9 + j 3.7	1.000	120.0 + j 0.0	1.000	119.3 + j 0.3	1.001
1018 kHz	8.0 + j 4.1	1.054	117.9 + j 1.2	1.020	115.9 – j 2.3	1.041

Tuning Engineer: 
Bobby L. Cox

Date: 14 May 2014

* NOTE: Factory measured ATU sideband performance is expected to provide this predicted bandwidth at TX finals. Data includes the effects of the series trap filter rejecting 657 kHz.

KINTRONIC LABS, Inc.

P.O. BOX 845 BRISTOL, TN 37621
1.423.878.3141 FAX: 1.423.878.4224

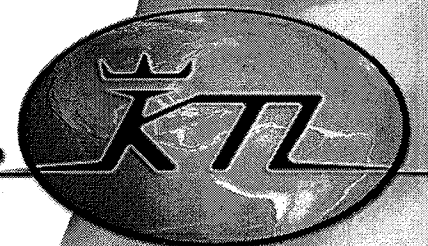

www.kintronic.com